

Ballew Saw and Tool

2017 CATALOG #48

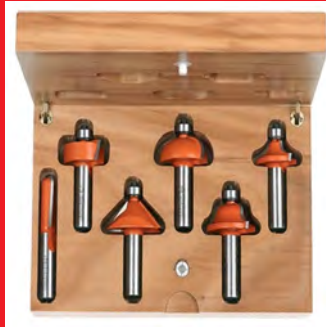

Saw Blades



Router Bits



Sanding Belts



Shaper Cutters



Magic Molder



CNC Tooling



**CNC Sharpening
& Profiling**



Knives & Steel



**Boring & Drilling Tools
and more.....**

FAX: 417-865-3797
E-mail: jack@ballewsaw.com

Visit Us Online:
ballewsaw.com

Call Us Toll Free
800-288-7483

GARVIE



OCTOBER 26, 1923 - OCTOBER 7, 1986

EDITH



FEBRUARY 20, 1920 - SEPTEMBER 30, 2005

STEVE



JULY 31, 1955 - SEPTEMBER 20, 2013

A SHORT HISTORY OF BALLEW SAW & TOOL

Ballew Saw Works was started by Garvie and Edith Ballew on April 1, 1968. The name was changed to Ballew Saw & Tool and was incorporated in 1979.

Garvie was a Pearl Harbor survivor aboard the USS Utah. His ship was moored at Pearl Harbor when the Japanese attacked. His ship capsized within a few minutes of being struck by two torpedoes carried by the enemy planes. He was able to abandon ship and spent the rest of the day in the water waiting to be picked up. He was later assigned to a submarine and spent the remainder of the war on submarine duty. After his discharge he used the "G.I. Bill" to learn sharpening and hammering of large sawmill blades in Poplar Bluff, Missouri.

In 1946 he married Edith Wood and remained married until his death. In the 50's he moved his family to Madison, Illinois, where he sharpened saws at Dow Chemical's magnesium plant, and then with A. F. Chapman in St. Louis, Missouri.

By now, his PTSD (called shell shock in WWII) was bothering him, so at the urging of his wife and brother-in-law Charles Wood, he thought about moving to Springfield and opening a sharpening shop. His brother-in-law would be a good partner and influence, for he also was a Pearl Harbor survivor. He was aboard the USS Phoenix and was injured in the attack. As a result of the attack, he would spend the rest of his life in a wheelchair. I learned early on not to discuss or suggest buying anything from Japan or Italy around either of them. Both became more tolerant as they grew older, but the memories of war remained until their deaths.

By 1968, Garvie's only daughter Barbara, had graduated from the University of Illinois, and was working for IBM, where she worked until retiring. She was the smart one in the family. Jack (the oldest son) had been in the Navy for seven years and was in flight training in Kingsville, Texas. Garvie's youngest son Steve, was ready to start high school. Garvie and Edith thought this would be a good time to "pull up stakes", as they said, and head west. It was a nervy move since he was 45 and had no backup plan.

In 1972, Steve graduated from Central High School and pursued his true love: music. He played in many rock bands as a drummer, and was involved with music until his death.

Jack Served in the Navy until 1977 and The Missouri National Guard until 1988. After moving to Springfield, Jack started helping Steve and his parents with the business.

Neither of the "boys" (as their mother called them, until her death) worked as hard as their parents. That's when the idea of sitting at a desk, eating Fritos, drinking Pepsi, talking, joking and selling things to customers came to them. Steve was a master at this, and would grow the business singlehandedly until Jack left the sharpening part of the business.

Both Garvie and Edith were active in the business until their deaths. The business was then run by Steve and Jack until Steve's death in 2013.

GENERAL INFORMATION

Phone: 1-800-288-7483

Fax: 417-865-3797

www.ballewsaw.com

STORE HOURS

Monday thru Friday - 8:30 am to 4:30 pm (Central).

Our product showroom is also open Monday thru Friday from 8:30 am to 4:30 pm (Central).

We will be closed the week of July 4th and Christmas Eve thru New Years Day for annual vacation.

SHIPPING

We ship merchandise via United Parcel Service. Overnight, two-day, third day select. Postal delivery other options are available at an additional charge. Call for more information.

FREE FREIGHT OFFER

Ballew Saw & Tool, Inc. will pay your freight on most orders that total more than **\$200.00** and that can be shipped via standard UPS to the continental United States. **There are some items where freight is not prepaid, such as screws, hoses, glue and some other items that are very heavy.** If in doubt, be sure to ask if your order qualifies for prepaid freight. Call or email for freight charges if ordering outside the continental US.

If a qualified order has more than one shipment, all shipments will be prepaid. **Items shipped by truck, US mail, special orders or air freight are excluded from this offer, unless otherwise indicated.** A UPS Ground charge will be added to orders made that are lower than **\$200.00**.

Any sharpening services follow the same rules. If your tool sharpening order is **\$200.00** or more we will pay your return freight. Sharpening orders that are sent in wooden containers are subject to additional shipping charges.

OTHER INFORMATION

Due to catalog size issues, we only stock the most frequently requested items from a large selection of companies that we represent. We strive to keep prices and information up to date, however, many companies have temporary sales or add new items after the catalog is printed. **Please be aware that prices and product information are subject to change without notice.**

TERMS

We accept Visa, Mastercard, American Express, Discover cards and online with PayPal. Prepaid orders by personal check are permissible. Please allow time for check to clear (2 to 3 weeks) before your order is shipped. COD's are available at an additional charge of \$20.00.

COD's ONLY PAYABLE BY CERTIFIED CHECK, OR MONEY ORDER

If you have any billing questions, you must call **1-417-865-7511** and ask for bookkeeping. Our "800" line is specifically reserved for ordering.

Our Terms can be extended for **Public Schools** and **Institutions** but only when a written Purchase Order is provided. If a quotation is required, we will gladly provide one promptly.

SHORTAGES

All shipments must be checked for shortages within 15 days of receipt of order. **AFTER 15 DAYS** no claims for shortage will be allowed.

RETURNS

In all cases, call before returning any product for warranty to help minimize inconvenience on both ends. Most products may be returned within 30 days of purchase. Customers must request a Return Authorization before sending anything back to us. Ballew Saw & Tool will provide the customer with a return authorization number, which is to be written on the outside of the package.

All return items are subject to a **15% restocking fee**, and **some items are not returnable**. Title and risk of loss to the products will remain with the customer until the products are physically received at Ballew Saw & Tool. Products must be returned undamaged, freight prepaid and in the original packaging. Customers may wish to insure the products against loss or damage during shipping.

Credit will be issued when the products have been physically received (minus shipping). Please include your invoice number or packing slip with your return, or we will be unable to process it.







DECIMAL & MILLIMETER EQUIVALENTS









<u>Fraction</u>	<u>Decimal</u>	<u>MM</u>	<u>Fraction</u>	<u>Decimal</u>	<u>MM</u>	<u>Fraction</u>	<u>Decimal</u>	<u>MM</u>
1/64	.015625	0.397	23/64	.359375	9.128	45/64	.703125	17.859
1/32	.031250	0.794	3/8	.375000	9.525	23/32	.718750	18.256
3/64	.046875	1.191	25/64	.390625	9.922	47/64	.734375	18.653
1/16	.062500	1.588	13/32	.406250	10.319	3/4	.750000	19.050
5/64	.078125	1.984	27/64	.421875	10.716	49/64	.765625	19.447
3/32	.093750	2.381	7/16	.437500	11.113	25/32	.781250	19.844
7/64	.109375	2.778	29/64	.453125	11.509	51/64	.796875	20.241
1/8	.125000	3.175	15/32	.468750	11.906	13/16	.812500	20.638
9/64	.140625	3.572	31/64	.484375	12.303	53/64	.828125	21.034
5/32	.156250	3.969	1/2	.500000	12.700	27/32	.843750	21.034
11/64	.171875	4.366	33/64	.515625	13.097	55/64	.859375	21.828
3/16	.187500	4.763	17/32	.531250	13.494	7/8	.875000	22.225
13/64	.203125	5.159	35/64	.546875	13.891	57/64	.890625	22.622
7/32	.218750	5.556	9/16	.562500	14.288	29/32	.906250	23.019
15/64	.234375	5.953	37/64	.578125	14.684	59/64	.921875	23.416
1/4	.250000	6.350	19/32	.593750	15.081	15/16	.937500	23.813
17/64	.265625	6.747	39/64	.609375	15.478	61/64	.953125	24.209
9/32	.281250	7.144	5/8	.625000	15.875	31/32	.968750	24.606
19/64	.296875	7.541	41/64	.640625	16.272	63/64	.984375	25.003
5/16	.312500	7.938	21/32	.656250	16.669	1	1.00000	25.400
21/64	.328125	8.334	43/64	.671875	17.066			
11/32	.343750	8.731	11/16	.687500	17.463			











1 mm = .03937
.001" = .0254 mm













<u>MM</u>	<u>Inches</u>	<u>MM</u>	<u>Inches</u>	<u>MM</u>	<u>Inches</u>	<u>MM</u>	<u>Inches</u>	<u>MM</u>	<u>Inches</u>
.1	.0039	14	.5512	36	1.4173	58	2.2835	80	3.1496
.2	.0079	15	.5906	37	1.4567	59	2.3228	81	3.1890
.3	.0118	16	.6299	38	1.4961	60	2.3622	82	3.2283
.4	.0157	17	.6693	39	1.5354	61	2.4016	83	3.2677
.5	.0197	18	.7087	40	1.5748	62	2.4409	84	3.3071
.6	.0236	19	.7480	41	1.6142	63	2.4803	85	3.3465
.7	.0276	20	.7874	42	1.6535	64	2.5197	86	3.3858
.8	.0315	21	.8268	43	1.6929	65	2.5591	87	3.4252
.9	.0354	22	.8661	44	1.7323	66	2.5984	88	3.4646
1	.0394	23	.9055	45	1.7717	67	2.6378	89	3.5039
2	.0787	24	.9449	46	1.8110	68	2.6772	90	3.5433
3	.1181	25	.9843	47	1.8504	69	2.7165	91	3.5827
4	.1575	26	1.0236	48	1.8898	70	2.7559	92	3.6220
5	.1969	27	1.0630	49	1.9291	71	2.7953	93	3.6614
6	.2362	28	1.1024	50	1.9685	72	2.8346	94	3.7008
7	.2756	29	1.1417	51	2.0079	73	2.8740	95	3.7402
8	.3150	30	1.1811	52	2.0472	74	2.9134	96	3.7795
9	.3543	31	1.2205	53	2.0866	75	2.9528	97	3.8189
10	.3937	32	1.2598	54	2.1260	76	2.9921	98	3.8583
11	.4331	33	1.2992	55	2.1654	77	3.0315	99	3.8976
12	.4724	34	1.3386	56	2.2047	78	3.0709	100	3.9370
13	.5118	35	1.3780	57	2.2441	79	3.1102		









Table of Contents

 <u>Abrasive Fabricators</u>	
➤ Sanding Discs	001
➤ Sanding Belts	001
➤ Abrasive Rolls	002
 <u>A.G.E</u>	
➤ Saw Blades	004
 <u>Amana</u>	
➤ Counter Sinks & Counter Bores	006
➤ Router Bits	
• Straight & Spirals	010
• V Grooving & Sign Making	016
• Miniature	019
• Profile	020
• Solid Surface	027
➤ Saw Blades	
• Festool Alternatives	039
• Ripping & General Purpose	040
• Cut Off & Trim	045
• Melamine & Solid Surface	050
• Non-Ferrous	052
• Dado Sets	054
➤ Shaper Cutters	056
 <u>Ballew Saw & Tool</u>	
➤ Sharpening Services	069
➤ Custom Profile Knives	071
 <u>Bosch</u>	
➤ T-Shank Jig Saw Blades	072
➤ U-Shank Jig Saw Blades	074
➤ Router Bits	076
➤ Sanding Pads & Discs	084
 <u>Byrd</u>	
➤ Shelix Heads	085
➤ Insert Tooling	087
 <u>CMT</u>	
➤ Boring System	101
➤ Cutter Heads & Knives & Boring Bits	103
➤ Dado Sets	105
➤ Router Bits	107
➤ Saw Blades	116

	<u>ComSurge Tooling</u>	
	➤ Drill Bits	118
	➤ Boring Bits Adapter	120
	➤ Screw Shank Boring Bits	122
	➤ Counter Bores & Counter Sinks	125
	➤ Multi-Spur Bits	129
	<u>Delta</u>	
	➤ Tape Measurers & Accessories	131
	<u>Door Store</u>	
	➤ Jigs & Patterns for Cabinet Doors	132
	<u>Dynabrade</u>	
	➤ Air Sanders & Accessories	133
	<u>FEIN</u>	
	➤ Blades & Accessories	135
	➤ Small Power Tools and Sets	139
	<u>Festool</u>	
	➤ Small Power Tools	140
	➤ Saw Blades	141
	➤ Accessories	142
	<u>Forest City (Close Out on Tooling)</u>	
	➤ Boring Bits	143
	<u>Freeborn Shaper Cutters</u>	
	➤ Discontinued Mini-Pro "T" Alloy	154
	➤ Insert Tooling	156
	➤ Cope & Pattern Sets	165
	➤ Raised Panel	174
	➤ Door Edge	179
	➤ Glue Joint	182
	➤ V-Paneling Sets	184
	➤ Straight Top Groovers	187
	➤ Roundover	188
	➤ Lock Mitre	190
	➤ Bearings & Accessories	192
	➤ 4 Wing Flute Cutters	194
	<u>Freud</u>	
	➤ Forstner Bits	196
	➤ Dado Sets	197
	➤ Planer & Jointer Knives	199
	➤ Router Bits	200
	➤ Industrial Saw Blades	208
	➤ Diablo Saw Blades	218
	➤ Cabinet Door Making Cutter Sets	219
	➤ Profile Cutters & Knives	221
	➤ Shaper Cutters	224

 <u>FS Tool</u>	
➤ Dado Sets	234
➤ Saw Blades	235
 <u>Global</u>	
➤ Planer & Jointer Knives Sets	245
➤ Portable Planer & Electric Handheld Planer knives Sets	249
➤ Insert Knives	250
➤ Molding Steel	252
 <u>High Speed Steel</u>	
➤ Circular Saw Blades	253
 <u>Hitachi</u>	
➤ Band Saw Blades	254
➤ Small Power Tools	255
 <u>Imperial Blades</u>	258
 <u>Kreg Tools</u>	
➤ Cutting & Measuring	262
➤ Joining	268
➤ Accessories	271
➤ Screws	272
➤ Pocket Hole Machines	276
➤ Clamping Tools	277
➤ Precision Routing Systems	280
 <u>LRH Shaper Cutter</u>	
➤ Brazed Cutters	284
➤ Old Discontinued Designs	288
➤ Special Items	298
➤ Insert Tooling	300
 <u>Magic Molders</u>	305
 <u>Mirka Sand Paper</u>	
➤ 5" & 6" Discs	310
➤ 9 X 11" Sheets	312
➤ Sanding Pads	312
➤ Rolls	312
➤ Abralon & Abranet	312
 <u>Miscellaneous & Close Out Goods</u>	314
 <u>Olson Band Saw Blades</u>	315

 <u>Onsrud</u>	
➤ High Speed Steel.....	316
➤ Hoggers.....	320
➤ Spirals.....	327
➤ 8 Facet Drills.....	359
➤ PCD.....	360
➤ Blade and Arbor & Dado Sets.....	362
➤ Drill and Boring Bits.....	364
 <u>Original Saw Company</u>	369
 <u>Panasonic Cordless Drill/Driver Kit</u>	379
 <u>Popular Saw Blades</u>	
➤ Panel Saws.....	371
➤ General Purpose.....	375
➤ Melamine.....	385
➤ Dado Sets & Plastic.....	386
➤ Truss & Component.....	387
➤ Non-Ferrous.....	389
➤ Large Diameter 22" -30".....	392
➤ Lucas Saws & Strob Saws.....	393
 <u>Porter Cable</u>	
➤ Accessories.....	394
➤ Small Power Tools.....	395
 <u>Reliable Cutting Tools</u>	
➤ Cope Crafter.....	396
➤ Panel Crafter.....	397
➤ Door Crafter.....	398
 <u>Serious Toolworks</u>	399
 <u>Southeast Tool</u>	
➤ Boring Bits.....	400
➤ Vix Bits.....	403
➤ Carving Bits.....	406
 <u>Space Balls</u>	407
 <u>Sunmight</u>	
➤ 5" & 6" Sanding Discs.....	408
 <u>Systi-Matic</u>	
➤ Close Out on Remaining Saw Blades.....	410
 <u>T-Tool</u>	
➤ Tool Holders.....	414
➤ Accessories.....	416

	<u>Techniks</u>	
	➤ Collets.....	417
	➤ Pull Studs.....	418
	➤ Spanner Wrenches	419
	<u>Tersa & Terminus</u>	
	➤ High Speed Steel & Carbide Replaceable Knives.....	420
	<u>Velepec</u>	
	➤ Edge Profile Bits	421
	➤ Vel-Vet Tough Bearings	423
	➤ Router Bits.....	424
	<u>Vortex</u>	
	➤ Solid Carbide Bits.....	430
	➤ MDF Door Cutter.....	443
	➤ Insert Router Bits.....	444
	<u>W. L. Fuller</u>	
	➤ Counter Sinks	447
	➤ Plug Cutters	449
	➤ Drill Bits	450
	<u>Whiteside Router Bits</u>	
	➤ Dovetail.....	453
	➤ Solid Carbide Spirals.....	455
	➤ Straight Bits.....	459
	➤ Flush Trim	470
	➤ Profile Bits.....	471
	➤ MDF Doors	480
	➤ Raised Panel & Rail/Stile	483
	➤ Boring & Router Bits	489
	➤ Transom Drill Bits.....	493
	<u>Williams & Hussey</u>	
	➤ Molding Steel	497
	➤ Machineries	498
	• Accessories	501
	<u>Wood Stock</u>	
	➤ Boring Bits	505
	➤ Dust Collector Accessories.....	506
	➤ Accessories for Wood Working	510
	➤ Bearings & Bushings.....	512

ABRASIVE FABRICATORS



Cloth-backed Sanding Belt

*Need a Belt in a Special Size?
Call Us for a Quote on Custom Sizes.*

9" Adhesive Backed Discs

PART No.	GRIT	PRICE
AD960	60	\$3.38
AD980	80	\$3.21
AD9100	100	\$3.11
AD9120	120	\$3.11

10" Adhesive Backed Discs

PART No.	GRIT	PRICE
AD1060	60	\$4.22
AD1080	80	\$4.01
AD10100	100	\$3.81
AD10120	120	\$3.81

12" Adhesive Backed Discs

PART No.	GRIT	PRICE
AD1260	60	\$5.85
AD1280	80	\$5.57
AD12100	100	\$5.41
AD12120	120	\$5.41

16" Adhesive Backed Discs

PART No.	GRIT	PRICE
AD1660	60	\$9.90
AD1680	80	\$8.90
AD16100	100	\$8.90
AD16120	120	\$8.90

2-1/4" x 14" Multi-Purpose Abrasive Belts

PART No.	GRIT	Quantity	PRICE
B501	60	5	\$11.95
B502	80	5	\$11.95
B503	100	5	\$11.95
B504	120	5	\$11.95
B505	150	5	\$11.95
B506	180	5	\$11.95
B510	Assortment - One of Each 60, 80, 100, 120, 180		\$11.95

Portable Belts ("X" WT)

PART No.	GRIT	QUANTITY	PRICE
3x21x36	36	10	\$14.65
3x21x60	60	10	\$12.60
3x21x80	80	10	\$12.27
3x21x100	100	10	\$12.25
3x21x120	120	10	\$12.25
3x24x36	36	10	\$14.81
3x24x60	60	10	\$13.79
3x24x80	80	10	\$13.29
3x24x100	100	10	\$12.95
3x24x120	120	10	\$12.95
4x24x36	36	10	\$19.59
4x24x60	60	10	\$17.03
4x24x80	80	10	\$16.53
4x24x100	100	10	\$15.84
4x24x120	120	10	\$15.84

6" x 48" Sanding Belts

PART No.	GRIT	PRICE
AB64860	60	\$5.38
AB64880	80	\$4.89
AB648100	100	\$4.58
AB648120	120	\$4.58
AB648150	150	\$4.58

6" x 80" Sanding Belts

PART No.	GRIT	PRICE
AB68060	60	\$12.09
AB68080	80	\$11.28
AB680100	100	\$10.12
AB680120	120	\$10.12
AB680150	150	\$10.12

6" x 89" Sanding Belts

PART No.	GRIT	PRICE
AB68960	60	\$12.78
AB68980	80	\$12.54
AB689100	100	\$11.25
AB689120	120	\$11.25
AB689150	150	\$11.25

6" x 108" Sanding Belts

PART No.	GRIT	PRICE
AB610860	60	\$14.90
AB610880	80	\$13.61
AB6108100	100	\$12.66
AB6108120	120	\$12.66
AB6108150	150	\$12.66

ABRASIVE FABRICATORS

6" x 132" Sanding Belts

PART No.	GRIT	PRICE
AB613260	60	\$15.67
AB613280	80	\$14.33
AB6132100	100	\$13.76
AB6132120	120	\$13.76
AB6132150	150	\$13.76

16" x 48" Sanding Belts

PART No.	GRIT	PRICE
AB164836	36	\$24.27
AB164860	60	\$19.72
AB164880	80	\$18.42
AB1648100	100	\$17.60
AB1648120	120	\$17.60
AB1648150	150	\$17.60
AB1648180	180	\$17.60
AB1648220	220	\$17.60

25" x 60" Sanding Belts

(sold by the box only)

PART No.	GRIT	QUANTITY	PRICE
AB256036	36	3	\$30.76 Each Belt
AB256060	60	3	\$29.66 Each Belt
AB256080	80	3	\$28.12 Each Belt
AB2560100	100	5	\$27.13 Each Belt
AB2560120	120	5	\$27.13 Each Belt
AB2560150	150	5	\$27.13 Each Belt
AB2560180	180	5	\$27.13 Each Belt
AB2560220	220	5	\$27.13 Each Belt

37" x 60" Sanding Belts

(sold by the box only)

PART No.	GRIT	QUANTITY	PRICE
AB376036	36	3	\$57.85 Each Belt
AB376060	60	3	\$44.89 Each Belt
AB376080	80	3	\$42.96 Each Belt
AB3760100	100	5	\$41.04 Each Belt
AB3760120	120	5	\$41.04 Each Belt
AB3760150	150	5	\$41.04 Each Belt
AB3760180	180	5	\$41.04 Each Belt
AB3760220	220	5	\$41.04 Each Belt

37" x 75" Sanding Belts

(sold by the box only)

PART No.	GRIT	QUANTITY	PRICE
AB377536	36	3	\$60.94 Each Belt
AB377560	60	3	\$52.23 Each Belt
AB377580	80	3	\$49.33 Each Belt
AB3775100	100	5	\$47.42 Each Belt
AB3775120	120	5	\$47.42 Each Belt
AB3775150	150	5	\$47.42 Each Belt
AB3775180	180	5	\$47.42 Each Belt
AB3775220	220	5	\$47.42 Each Belt

43" x 60" Sanding Belts

(sold by the box only)

PART No.	GRIT	QUANTITY	PRICE
AB436036	36	3	\$70.72 Each Belt
AB436060	60	3	\$48.86 Each Belt
AB436080	80	3	\$46.53 Each Belt
AB4360100	100	5	\$45.02 Each Belt
AB4360120	120	5	\$45.02 Each Belt
AB4360150	150	5	\$45.02 Each Belt
AB4360180	180	5	\$45.02 Each Belt
AB4360220	220	5	\$45.02 Each Belt

43" x 75" Sanding Belts

(sold by the box only)

PART No.	GRIT	QUANTITY	PRICE
AB437536	36	3	\$70.47 Each Belt
AB437560	60	3	\$60.39 Each Belt
AB437580	80	3	\$57.04 Each Belt
AB4375100	100	5	\$54.85 Each Belt
AB4375120	120	5	\$54.85 Each Belt
AB4375150	150	5	\$54.85 Each Belt
AB4375180	180	5	\$54.85 Each Belt
AB4375220	220	5	\$54.85 Each Belt

52" x 60" Sanding Belts

(sold by the box only)

PART No.	GRIT	QUANTITY	PRICE
AB527536	36	3	\$49.27 each belt
AB527560	60	3	\$42.66 each belt
AB527580	80	3	\$40.75 each belt
AB5275100	100	5	\$38.99 each belt
AB5275120	120	5	\$38.99 each belt
AB5275150	150	5	\$38.99 each belt
AB5275180	180	5	\$38.99 each belt
AB5275220	220	5	\$38.99 each belt

Custom size belts can be ordered in minimum quantities of 5. Please call with length, width, and grit.

2" Delta Drum Sander 50 Yd. Abrasive Rolls

PART No.	GRIT	PRICE
ASR250-36	36	\$92.36
ASR250-60	60	\$75.31
ASR250-80	80	\$69.52
ASR250-100	100	\$66.12
ASR250-120	120	\$66.12
ASR250-150	150	\$66.12
ASR250-220	220	\$66.12

ABRASIVE FABRICATORS

3" Performax Drum Sanders 50 Yd. Abrasive Rolls

PART No.	GRIT	PRICE
ASR350-36	36	\$125.31
ASR350-60	60	\$102.74
ASR350-80	80	\$101.02
ASR350-100	100	\$93.87
ASR350-120	120	\$93.87
ASR350-150	150	\$93.87
ASR350-180	180	\$93.87
ASR350-220	220	\$93.87

Pictured at right.



**3" Performax Drum Sanders
50-yard Abrasive Rolls**

4" Abrasive 25 Yard Rolls (Cloth Backed)

Part No.	Grit	Price
ASR425-36	36	\$89.80
ASR425-60	60	\$74.37
ASR425-80	80	\$68.55
ASR425-100	100	\$64.77
ASR425-120	120	\$64.77
ASR425-150	150	\$64.77
ASR425-180	180	\$64.77
ASR425-220	220	\$64.77

6" Abrasive 25 Yard Rolls (Cloth Backed)

PART No.	GRIT	PRICE
ASR625-36	36	\$134.79
ASR625-60	60	\$109.91
ASR625-80	80	\$101.56
ASR625-100	100	\$95.94
ASR625-120	120	\$95.94
ASR625-150	150	\$95.94
ASR625-180	180	\$95.94
ASR625-220	220	\$95.94

Need a Felt in a Special Size?

*Call Us for a Quote on
Custom Sizes.*

PEC

Heavy Duty Graphite Coated Canvas
Pre-Cut Rolls in The Sizes Listed Below.

PART No.	DESCRIPTION	PRICE
HD4-6	4" Wide x 6' Long Roll	\$31.76
HD4-12	4" Wide x 12' Long Roll	\$63.52
HD6-6	6" Wide x 6' Long Roll	\$42.40
HD6-12	6" Wide x 12' Long Roll	\$84.80
HD8-6	8" Wide x 6' Long Roll	\$52.96
HD8-12	8" Wide x 12' Long Roll	\$105.92



Felt For Wide Belt Sanders & Other Sanding Machines

PART No.	DESCRIPTION	PRICE
F26	3/8" Thick x 1-3/4" Wide x 26" Long	\$39.00
F38	3/8" Thick x 1-3/4" Wide x 38" Long	\$59.00
F44	3/8" Thick x 1-3/4" Wide x 44" Long	\$67.50



A.G.E INDUSTRIAL SAW BLADES

COMBINATION RIP/CROSSCUT (4+1)							These blades will effectively rip or crosscut hardwoods, softwoods, particleboard, and plywood.
Tool #	Diameter	Teeth	Kerf MM Inch	Plate MM Inch	Hook Angle	Bore	Price
MD10-500	10"	50	3.2 .126	2.2 .087	15°	5/8"	\$48.41

GENERAL PURPOSE (Alternate Top Bevel)							These are general purpose blades which provide good results when ripping or crosscutting in a variety of materials.
Tool #	Diameter	Teeth	Kerf MM Inch	Plate MM Inch	Hook Angle	Bore	Price
MD10-400	10"	40	3.2 .126	2.2 .087	15°	5/8"	\$43.19
MD10-400-30	10"	40	3.2 .126	2.2 .087	15°	30mm	\$44.94
MD12-480	12"	48	3.2 .126	2.2 .087	15°	1"	\$47.71

Cut-Off & Crosscut (Alternate Top Bevel)							These blades are designed for smooth crosscuts in a variety of materials from hardwoods, softwoods and sheet goods including chipboard.
Tool #	Diameter	Teeth	Kerf MM Inch	Plate MM Inch	Hook Angle	Bore	Price
MD10-600	10"	60	3.2 .126	2.2 .087	12°	5/8"	\$47.81
MD10-606	10"	60	2.3 .090	1.8 .071	0°	5/8"	\$57.86
MD10-800	10"	80	3.2 .126	2.2 .087	10°	5/8"	\$61.67
MD10-816TB	10"	80	2.3 .090	1.8 .071	0°	5/8"	\$63.00
MD12-600	12"	60	3.2 .126	2.2 .087	12°	1"	\$57.65
MD12-606	12"	60	2.8 .110	2.2 .086	0°	1"	\$56.98
MD12-800	12"	80	3.4 .135	2.5 .100	10°	1"	\$84.81
MD12-806	12"	80	2.3 .090	1.8 .071	0°	1"	\$74.52
MD12-960	12"	96	3.2 .126	2.2 .087	10°	1"	\$77.63

Thin Kerf Miter/Finishing (Alternate Top Bevel)							These blades are designed for smooth crosscuts in a variety of materials from hardwoods, softwoods and sheet goods including chipboard. Ideal for underpowered saw; thin kerf blades reduce waste in expensive materials and require less horsepower to operate.	
Tool #	Diameter	Teeth	Kerf MM Inch	Plate MM Inch	Hook Angle	a°	Bore	Price
MD10-606	10"	60	2.3 .090	1.8 .071	0°	10°	5/8"	\$57.86
MD10-816TB	10"	80	2.3 .090	1.8 .071	0°	10°	5/8"	\$63.00
MD12-606	12"	60	2.8 .110	2.2 .086	0°	20°	1"	\$56.98
MD12-806	12"	80	2.3 .090	1.8 .071	0°	10°	1"	\$74.52

Plywood/Laminate (Triple Chip Grind)							This blade is specifically designed for clean cuts in plywood and single-sided laminates. The greater number of teeth, triple-chip grind, and 10 degree hook angle provide an excellent balance between feed resistance and finish.
Tool #	Diameter	Teeth	Kerf MM Inch	Plate MM Inch	Hook Angle	Bore	Price
MD10-601	10"	60	3.2 .126	2.2 .087	12°	5/8"	\$51.38
MD10-801	10"	80	3.2 .126	2.2 .087	6°	5/8"	\$65.14
MD12-601	12"	60	3.2 .126	2.2 .087	6°	1"	\$76.72
MD12-961	12"	96	3.2 .126	2.2 .087	6°	1"	\$86.31

A.G.E INDUSTRIAL SAW BLADES

Heavy-Duty Miter/Double Miter (4+1)		These blades are designed especially for glass-smooth compound miter cuts in moldings & picture frame stock for use in a miter box and single/double miter machines.					
Tool #	Diameter	Teeth	Kerf MM Inch	Plate MM Inch	Hook Angle	Bore	Price
MD10-806	10"	80	2.9 .115	2.2 .087	-5°	5/8"	\$63.00
MD12-106	12"	100	3.2 .126	2.5 .098	-5°	1"	\$82.99
MD12-106-5/8	12"	100	3.2 .126	2.5 .098	-5°	5/8"	\$82.99

Double-Sided Melamine (H-Alternate Top Bevel)		These blades are designed for cutting double-sided melamine and veneered sheet goods on saws without a scoring unit. The sharp 30° bevels slice cleanly through fragile coatings and laminates.					
Tool #	Diameter	Teeth	Kerf MM Inch	Plate MM Inch	Hook Angle	Bore	Price
MD10-803	10"	80	3.2 .126	2.5 .098	-5°	5/8"	\$74.52
MD12-963	12"	96	3.2 .126	2.5 .098	-5°	1"	\$89.43
MD220-T643	220mm	96	3.2 .126	2.0 .079	0°	30mm	\$73.71

Non-Ferrous Metal/Aluminum (Triple Chip Grind)		These blades are designed specifically for cutting relatively thin-walled aluminum and non-ferrous extrusions and frames. Use coolant or blade wax and clamp down the work piece when cutting non-ferrous metals.					
Tool #	Diameter	Teeth	Kerf MM Inch	Plate MM Inch	Hook Angle	Bore	Price
MD10-105	10"	100	3.2 .126	2.5 .098	-5°	5/8"	\$90.06
MD10-805	10"	80	3.2 .126	2.5 .100	-5°	5/8"	\$86.63
MD12-105	12"	100	3.2 .126	2.5 .098	-5°	1"	\$110.60
MD12-105-5/8	12"	100	3.2 .126	2.5 .098	-5°	5/8"	\$110.60
MD14-105	14"	100	3.2 .126	2.5 .100	-6°	1"	\$132.20
MD15-105	15"	100	3.2 .126	2.5 .098	-6°	1"	\$138.01
MD12-725	12"	72	3.2 .126	2.5 .098	-6°	1"	\$106.19

Steel (Carbide-Tipped blades for alloy and virgin steel)		Designed to easily cut through steel studs, steel sheets, metal rods, steel pipes, channels & rebar. Note: Cutting high strength rebar materials will reduce blade life due to material toughness!					
--	--	--	--	--	--	--	--

WARNING: FOR USE WITH LOW RPM CHOP SAWS ONLY! Ganging materials being cut is not recommended. Damage to saw blades and machinery as well as personal injuries could result.

Tool #	Diameter	Teeth	Kerf Inch	Plate Inch	Recommended RPM Range	Grind	Bore	Price
STL305-80	12"	80	.086	.070	1300-1900	WWF	1"	\$119.28

Glue Line Ripping (Triple Chip Grand)		This special glue line blade shears the wood cleanly so there is no need to joint the stock prior to gluing. The precision triple-chip grind & extra-high hook angle allow aggressive feed rates, yet produce an extra-smooth cut finish. The thick plate and laser cut expansion slots minimize vibration. Use on table saws, sliding table saw, single and gang-rip operations					
Tool #	Diameter	Teeth	Kerf MM Inch	Plate MM Inch	Hook Angle	Bore	Price
MD10-301	10"	30	3.7 .145	2.5 .098	12°	5/8"	\$54.88

Solid Surface (Modified Triple Chip Grand)		This blade is designed for cutting plastic laminate and solid surface materials and other acrylic based materials. The triple chip grind is especially configured to leave a swirl-free cut in solid surface materials.					
Tool #	Diameter	Teeth	Kerf MM Inch	Plate MM Inch	Hook Angle	Bore	Price
MD12-848	12"	84	3.2 .126	2.2 .087	0°	1"	\$98.53

AMANA



CARBIDE-TIPPED COUNTERSINKS

Used to countersink and counterbore holes for the heads of screws in woods, plastic and non-ferrous materials. The 2-flute integral design ensures uniform and concentric results each and every time. Carbide tips provide chip free hole edges and last at least 40 times longer than steel countersinks. Available in a wide variety of sizes, complete with the HSS drill bit.

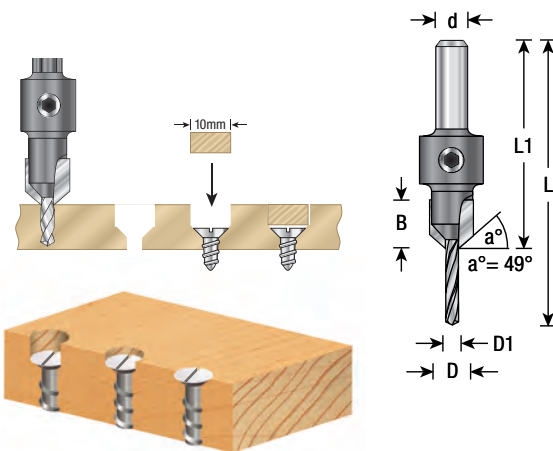

COUNTERSINKS

Carbide Tipped • For Wood Screws • 2-Wing

With Slow Spiral, HSS M2 DIN 338 Fully Ground Drill

Wood Screw Size	ØD	ØD1	B	Ød	L1	L	Repl. Drill Bit	Tool No.	Price
#4	11/32	3/32	1/2	5/16	1-5/8	2-1/4	630-002	55200	\$23.38
#4	3/8	7/64	1/2	5/16	1-5/8	2-3/8	630-098	55201	\$23.38
#6	5/16	1/8	1/2	5/16	1-5/8	2-9/16	630-102	55203	\$24.50
#6	3/8	1/8	1/2	5/16	1-5/8	2-9/16	630-102	55202	\$23.38
#6	1/2	1/8	1/2	5/16	1-5/8	2-9/16	630-102	55205	\$26.15
#6	25/64	9/64	1/2	5/16	1-5/8	2-3/4	630-802	55204	\$23.31
#8	25/64	5/32	1/2	5/16	1-5/8	2-7/8	630-202	55206	\$24.78
#8	7/16	11/64	1/2	5/16	1-5/8	3	630-302	55208	\$25.34
#10	7/16	3/16	1/2	3/8	1-3/4	3	630-402	55210	\$25.94
#10	1/2	3/16	1/2	3/8	1-3/4	3	630-402	55211	\$27.90
#12	15/32	7/32	1/2	3/8	1-3/4	3	630-502	55212	\$27.30

Replacement set screw #67083.

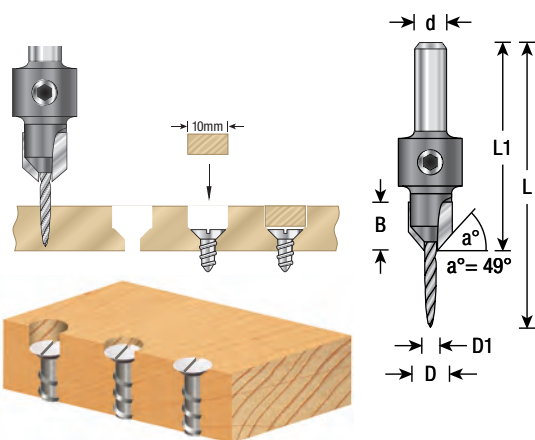

COUNTERSINKS

Carbide Tipped • For Wood Screws • 2-Wing

With Taper Point, HSS M2 DIN 338 Fully Ground Drill

Wood Screw Size	ØD	ØD1	B	Ød	L1	L	Repl. Drill Bit	Tool No.	Price
#4	11/32	3/32	1/2	5/16	1-5/8	2-1/4	630-262	55600	\$22.47
#6	3/8	1/8	1/2	5/16	1-5/8	2-9/16	630-266	55602	\$24.54
#6	25/64	9/64	1/2	5/16	1-5/8	2-3/4	630-268	55604	\$24.40
#8	7/16	11/64	1/2	5/16	1-5/8	3	630-272	55608	\$26.25
#10	7/16	3/16	1/2	3/8	1-3/4	3	630-274	55610	\$27.09

Replacement set screw #67083.

3D renderings & tool illustrations **not** shown at actual size. Wood profiles shown at actual size.

AMANA

COUNTERSINKS
Carbide Tipped*With Slow Spiral, HSS M2 DIN 338 Fully Ground Drill*

Drill pilot hole and tapered countersink for wood screws. Carbide tipped for long lasting results in hardwood, plywood, plastics, etc.

ØD	ØD1	Wood Screw Size	a°	Ød	L	Repl. Drill Bit	Tool No.	Price
3/8	5/64	#4	49°	1/4	2-1/8	630-001	55260	\$20.23
3/8	3/32	#6	49°	1/4	2-1/8	630-002	55262	\$20.23
3/8	7/64	#8	49°	1/4	2-1/8	630-098	55264	\$20.23
3/8	1/8	#10	49°	1/4	2-1/8	630-102	55266	\$20.23
1/2	9/64	#12	49°	1/4	2-1/8	630-802	55268	\$20.23
3/8	5/32	#12 to #14	49°	1/4	2-1/8	630-202	55269	\$20.23

Replacement set screw #67083. Hex key #5009.

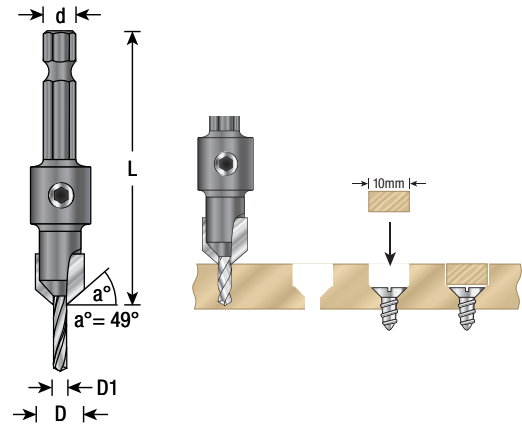
**COUNTERSINKS**
Carbide Tipped*With Taper Point, HSS M2 DIN 338 Fully Ground Drill*

Drill pilot hole and tapered countersink for wood screws. Carbide tipped for long lasting results in hard wood, plywood, plastics, etc.

ØD	ØD1	Wood Screw Size	a°	Ød	L	Repl. Drill Bit	Tool No.	Price
3/8	5/64	#4	49°	1/4	2-1/8	630-260	55620	\$22.26
3/8	3/32	#6	49°	1/4	2-1/8	630-262	55622	\$22.26
3/8	7/64	#8	49°	1/4	2-1/8	630-264	55624	\$22.26
3/8	1/8	#10	49°	1/4	2-1/8	630-266	55626	\$22.26
1/2	9/64	#12	49°	1/4	2-1/8	630-268	55628	\$22.26

Replacement set screw #67083. Hex key #5009.

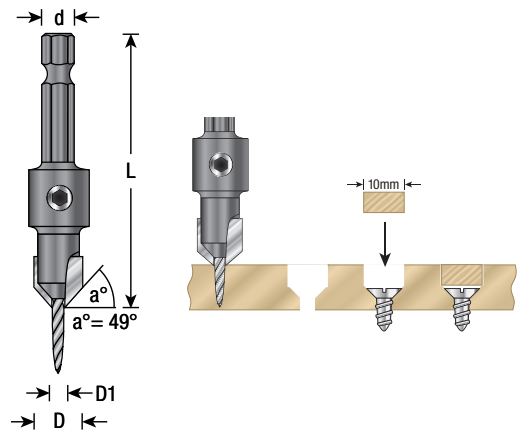
**COUNTERBORES**
Carbide Tipped*With Slow Spiral, HSS M2 DIN 338 Fully Ground Drill*

Flat bottom counterbores for using round head screws, hex bolts, etc. Includes pilot drill.

ØD	ØD1	Ød	L	Repl. Drill Bit	Tool No.	Price
3/8	3/16	1/4	2-3/16	630-402	55282	\$22.26
1/2	1/4	1/4	2-3/4	630-702	55286	\$19.01
5/8	1/4	1/4	2-3/4	630-702	55288	\$20.62

Replacement set screw #67083. Hex key #5009.

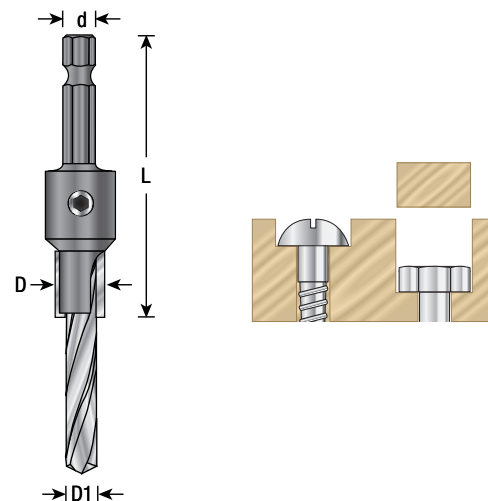

AMANA

Improved Spiral Action for Better Chip Ejection

COUNTERBORES

Fit Evans, Ritter, Unique, Marcon, Norfield® and Castle® Face Frame Machines

Carbide Tipped

Application: Features include precision ground carbide-tipped counterbore for splinter-free cutting, non-slip surface treatment for positive clamping, wide web design for superior strength and replaceable HSS fishtail drills.

Description	ØD	ØD1	Ød	L	Tool No.	Price
Counterbore	3/8	.136	3/8	4-1/16	424000	\$31.08
Replacement #8-32 NC set screw, #67010.						

#29 Replacement HSS Fish Tail Drills

Description	ØD1	Ød	L	Tool No.	Price
Standard	.136	—	2-7/8	424004	\$6.30
DHN Surface Treated for Longer Tool Life	.136	—	2-7/8	424006	\$6.58

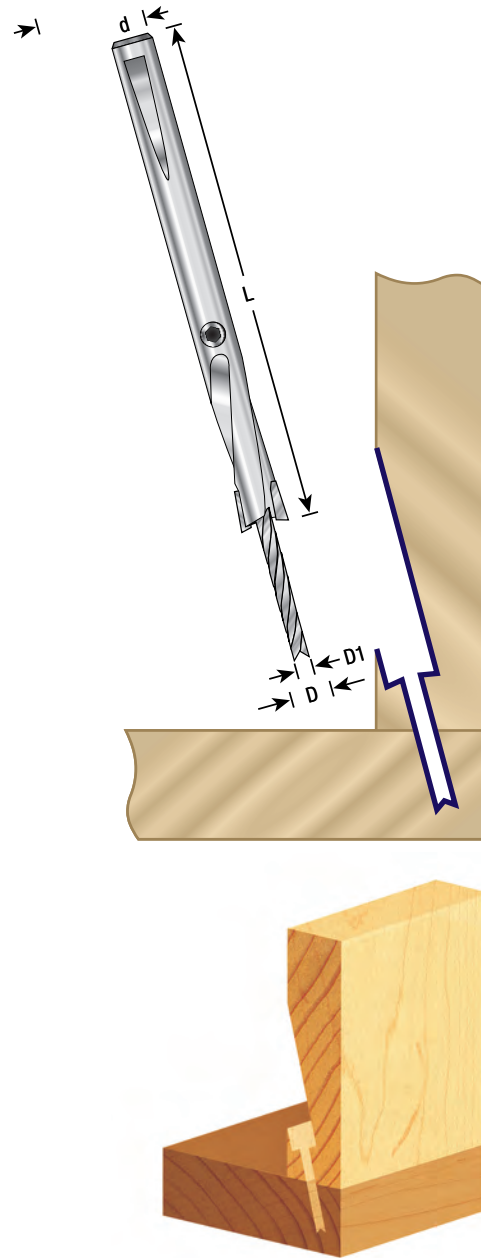

PLUG CUTTER FOR DRILL PRESS

Carbide Tipped • 1/2" Shank • 2 Flute

Must clamp work piece firmly to drill press table.

ØD	ØD1	B	Ød	L	Tool No.	Price
5/8	3/8	1/2	1/2	2-1/2	55220	\$40.67
25/32	1/2	1/2	1/2	2-1/2	55222	\$42.42
29/32	5/8	1/2	1/2	2-1/2	55224	\$44.66

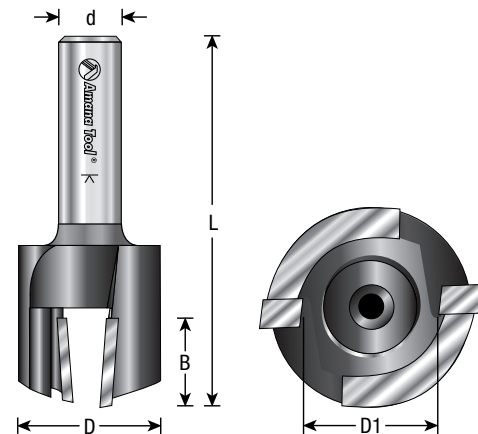
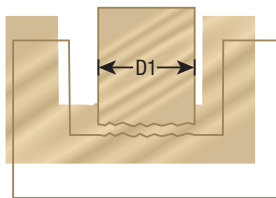

3D renderings & tool illustrations not shown at actual size. Wood profiles shown at actual size.

AMANA

'DI-COUNT'[™] ADJUSTABLE COUNTERSINK

Carbide-Tipped • 2-Wing

Accepts Drills* from 3/32" through 9/32" (Wood Screw Sizes #2 through #18).

* Drills not included.

ØD	a°	B	Ød	L	Tool No.	Price
7/16 to 19/32	45°	7/16	3/32 to 9/32	1-1/4	20200	\$17.47

Replacement allen screws (2 required) #67090.
Replacement 3mm hex key #5004 (included).

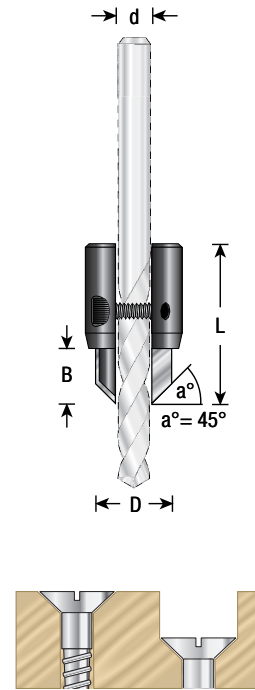
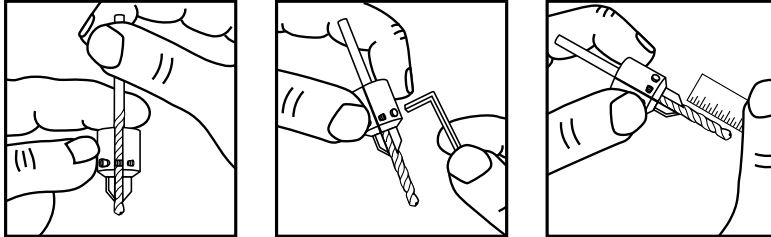

ADJUSTABLE UNIVERSAL DRILL DEPTH-STOPS

Can be clamped onto any drill* from 3mm to 10mm. An innovation and universal solution to the problem of drilling holes to an accurate depth. Special design to minimize any marks on the surface being drilled. User friendly – quick assembly and easy drill-depth adjustment.

* Drills not included.

Range of Drill Diameters	Tool No.	Price
3mm to 7mm (1/8 to 1/4)	20210	\$11.13
6mm to 10mm (1/4 to 3/8)	20212	\$12.95

Replacement 3mm hex key #5004 (not included).



† Application: Not to be used in portable drills or handheld routers.

3D renderings & tool illustrations **not** shown at actual size.

Wood profiles shown at actual size.

AMANA



STRAIGHT PLUNGE
Carbide Tipped • Single Flute
1/2" Shank

ØD	B	Ød	L	Tool No.	Price
1/4	3/4	1/2	2-1/2	45304	\$15.44
3/8	1	1/2	2-3/4	45302	\$14.98
5/16	3/4	1/2	2-1/2	45306	\$15.82

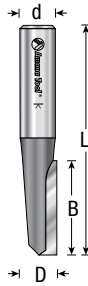

STRAIGHT PLUNGE
Carbide Tipped • 2 Flute • 1/4" Shank

ØD	B	Ød	L	Tool No.	Price
1/16	3/16	1/4	1-5/8	45190 ~†	\$18.27
3/32	1/4	1/4	1-3/4	45192 ~†	\$17.12
1/8	7/16	1/4	2	45200 ~†	\$12.85
5/32	7/16	1/4	2	45201 ~	\$14.56
3/16	7/16	1/4	2	45202 ~	\$13.79
7/32	3/4	1/4	2	45206	\$15.82
15/64	3/4	1/4	2	45203	\$14.77
1/4	1/2	1/4	2	45204	\$12.67
1/4	3/4	1/4	2	45208	\$12.99
1/4	1	1/4	2-1/4	45210	\$13.41
1/4	1	1/4	2-7/8	45211 *	\$15.68
9/32	1	1/4	2-1/4	45212	\$14.88
5/16	1	1/4	2-1/4	45214	\$14.00
3/8	3/4	1/4	2	45216	\$14.04
3/8	1	1/4	2-1/4	45218	\$14.81
7/16	1	1/4	2-1/8	45222	\$16.80
15/32	3/4	1/4	2	45223	\$16.80
1/2	3/4	1/4	1-3/4	45224	\$14.95
1/2	1	1/4	2-1/8	45226	\$15.82
5/8	3/4	1/4	2	45228	\$16.59
11/16	3/4	1/4	2	45229	\$19.57
23/32	3/4	1/4	2	45231	\$23.42
3/4	3/4	1/4	2	45230	\$18.31
13/16	3/4	1/4	2	45232	\$20.30
7/8	3/4	1/4	2	45234	\$22.86
1	3/4	1/4	2	45236	\$24.50

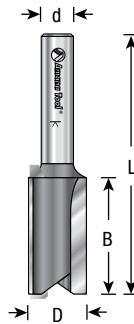

† Not guaranteed due to extremely small diameter
 Not guaranteed due to extreme length.
 ~ With solid carbide cutting edge.

**CNC STRAIGHT PLUNGE
OPEN FLUTE**

Carbide Tipped • 2 Flute • 3/4" Shank
 For high-volume production work with a CNC router.

ØD	B	Ød	L	Tool No.	Price
3/4	2-1/2	3/4	4-1/2	45457	\$54.32
3/4	2-1/2	3/4	4-1/2	45456	\$54.32

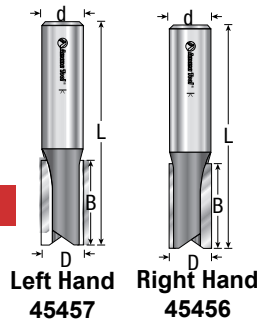

3D renderings & tool illustrations not shown at actual size.

STRAIGHT PLUNGE

Carbide Tipped • 2 Flute • 3/8" Shank

ØD	B	Ød	L	Tool No.	Price
3/8	1	3/8	2-1/2	45402	\$14.95
1/2	1	3/8	2-1/2	45406	\$16.35

Carbide Tipped • 2 Flute • 1/2" Shank

ØD	B	Ød	L	Tool No.	Price
1/4	3/4	1/2	2-1/2	45408 ~	\$16.80
1/4	1	1/2	2-3/4	45486	\$30.42
5/16	3/4	1/2	2-1/2	45410	\$15.61
5/16	1	1/2	2-3/4	45412	\$15.82
3/8	3/4	1/2	2-1/2	45413	\$15.61
3/8	1	1/2	2-3/4	45414	\$15.61
3/8	1-1/4	1/2	3	45415 *	\$16.70
7/16	1-1/4	1/2	3	45416	\$18.20
15/32	1-1/4	1/2	2-7/8	45425	\$19.53
1/2	1	1/2	2-5/8	45418	\$15.61
1/2	1-1/4	1/2	2-7/8	45420	\$15.72
1/2	1-1/2	1/2	3-1/8	45422	\$16.59
1/2	1-1/2	1/2	4-1/4	45424	\$20.69
1/2	2	1/2	4-1/4	45426	\$21.49
1/2	2-1/2	1/2	4-1/2	45427 *	\$29.54
1/2	3	1/2	5-1/4	45477	\$49.95
17/32	1-1/4	1/2	2-7/8	45429	\$21.00
9/16	1-1/4	1/2	2-7/8	45428	\$18.59
5/8	1	1/2	2-5/8	45430	\$18.52
5/8	1-1/4	1/2	2-7/8	45432	\$19.57
21/32	1-1/4	1/2	2-7/8	45435	\$22.19
23/32	1-1/4	1/2	2-7/8	45445	\$26.95
3/4	1	1/2	2-5/8	45438	\$20.90
3/4	1-1/4	1/2	2-7/8	45440	\$20.72
3/4	1-1/2	1/2	3-1/8	45442	\$23.14
3/4	2	1/2	3-5/8	45441	\$42.74
25/32	1-1/4	1/2	2-7/8	45443	\$23.87
13/16	1-1/4	1/2	2-7/8	45444	\$23.31
7/8	1-1/4	1/2	2-7/8	45446	\$23.87
1	1-1/4	1/2	2-7/8	45448	\$24.96
1	2	1/2	3-5/8	45447 Δ_{22}	\$56.32
1-1/4	1-1/4	1/2	2-7/8	45450 Δ_{22}	\$32.24
1-1/2	1-1/4	1/2	2-7/8	45452 Δ_{18}	\$38.85
1-3/4	1-1/4	1/2	2-7/8	45453 Δ_{16}	\$49.00
1-3/4	1-1/4	1/2	2-7/8	45453-CNC \star	\$53.66
2	1-1/4	1/2	2-7/8	45480 Δ_{12}	\$62.62
2	1-1/4	3/4	3-1/2	45480-CNC \star	\$73.26

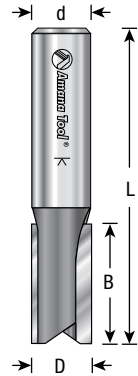
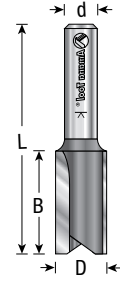

PRODUCTION SHEAR

Carbide Tipped • 2 Flute • 3° Down-Shear

ØD	B	Ød	L	Tool No.	Price
3/8	1	1/2	2-3/4	45414-PS	\$18.94
1/2	1-1/4	1/2	2-7/8	45420-PS	\$20.83
1/2	1-1/2	1/2	3-1/8	45422-PS	\$21.42
1/2	2	1/2	4-1/4	45426-PS	\$27.72

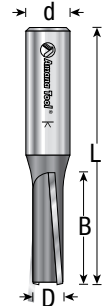

AMANA LEFT HAND PLUNGE Carbide Tipped • 2 Flute • 1/2" Shank

This special series of plunging straight bits is for reverse-rotation (counter-clockwise) routers.

ØD	B	Ød	L	Tool No.	Price
5/16	1	1/2	2-3/4	45412-LH	\$25.80
1/2	1-1/4	1/2	2-7/8	45420-LH	\$28.56
1/2	1-1/2	1/2	3-1/8	45422-LH	\$28.56
3/4	1-1/4	1/2	2-7/8	45440-LH	\$33.25

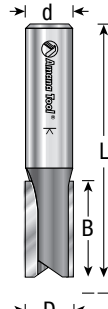

METRIC STRAIGHT PLUNGE

For Undersized Plywood Dado
Carbide Tipped • 2 Flute

ØD	Actual Plywood Thickness	B	Ød	L	Tool No.	Price
10mm	—	19mm	1/4	2-1/8	45219	\$19.60
18mm	18mm	3/4	1/4	2	45256	\$18.90
10mm	—	19mm	1/2	2-1/2	45417	\$20.69
12mm	12mm	1-1/4	1/2	2-7/8	45488	\$18.94
14mm	—	25mm	1/2	2-5/8	45431 *	\$22.19
18mm	18mm	1-1/4	1/2	2-7/8	45498	\$22.93

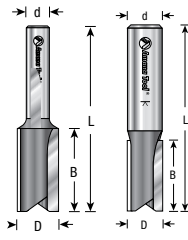

*14mm bits for cutting plastic pilaster.

UNDERSIZED PLYWOOD DADO

Carbide Tipped • 2 Flute
Straight Plunge Fractional Sizes

ØD	Actual Plywood Thickness	B	Ød	L	Tool No.	Price
15/64	1/4 minus 1/64 (6.0mm)	3/4	1/4	2	45203	\$14.77
7/32	1/4 minus 1/32	3/4	1/4	2	45206	\$15.82
15/32	1/2 minus 1/32	3/4	1/4	2	45223	\$16.80
15/32	1/2 minus 1/32	1-1/4	1/2	2-7/8	45425	\$19.53
23/32	3/4 minus 1/32	3/4	1/4	2	45231	\$23.42

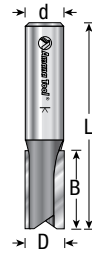

Note: For 6mm board, use #45203 (15/64) shown in fractional section above.

INSERT CARBIDE STRAIGHT

Single Flute & 2 Flute

ØD	B	Ød	L	Flutes	Repl. Knives	Tool No.	Price
1/2	30mm	1/2	3	1	AMA-30†	RC-1154	\$77.74
1/2	30mm	1/2	3	1	AMA-30†	RC-1154-LH**	\$117.15
7/8	50mm	1/2	4-1/8	1	RCK-50	RC-1166	\$74.94
5/8	30mm	1/2	3-3/8	2	AMA-30†	RC-1080	\$95.48
5/8	50mm	1/2	4-1/8	2	AMA-30†	RC-1082*	\$112.84
3/4	30mm	1/2	3-3/8	2	RCK-30	RC-1084	\$100.49
3/4	50mm	1/2	4-1/8	2	RCK-30	RC-1086*	\$118.86
7/8	30mm	1/2	3-3/8	2	RCK-30	RC-1088	\$103.29

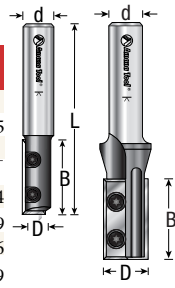

INSERT CARBIDE STRAIGHT

Single Flute & 2 Flute

ØD	B	Ød	L	Flutes	Repl. Knives	Tool No.	Price
3/8	20mm	1/2	2-7/8	1	RCK-32	RC-3100	\$73.08
1/2	30mm	1/2	3-1/8	1	RCK-34	RC-3110	\$66.99
1/2	30mm	1/2	3-1/8	2	RCK-34	RC-3200	\$83.20

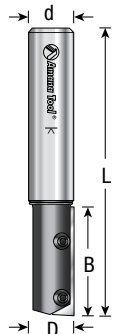

3D renderings & tool illustrations not shown at actual size.

SOLID CARBIDE SPIRAL FLUTE PLUNGE 2 Flute

ØD	B	Ød	L	'Up-Cut' Tool No.	'Down-Cut' Tool No.	Price
1/8	1/2	1/4	2	46100	46200	\$21.60
1/4	3/4	1/4	2-1/2	46102	46202	\$21.60
5/16	1	5/16	2-1/2	46115	46215	\$85.09
5/16	1	1/2	3	46119	46219	\$64.19
9/32	1	1/2	3	46117	46217	\$67.97
5/16	1-1/8	1/2	3	46318	—	\$65.70
3/8	1-1/4	1/2	3	46104	46204	\$62.55
1/2	1-1/4	1/2	3	46106	46206	\$66.05
1/2	1-5/8	1/2	3-1/2	46107	46207	\$72.91
5/8	1-5/8	5/8	3-1/2	46108	46208 *	\$159.64

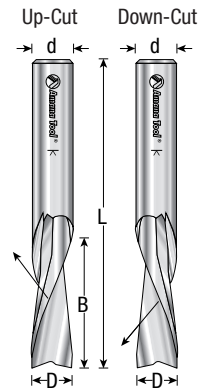

SOLID CARBIDE SPIRAL FLUTE PLUNGE FOR SOLID WOOD

ØD	B	Ød	L	'Up-Cut' Tool No.	'Down-Cut' Tool No.	Price
5/16	1-1/8	1/2	3	46353	46253	\$70.49
1/2	1-1/4	1/2	3	46361	46261	\$72.70
1/2	1-5/8	1/2	3-1/2	46363	46263	\$79.91

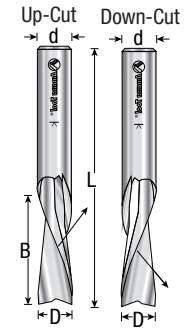

SOLID CARBIDE SPIRAL FLUTE PLUNGE

3 Flute
New three-flute design for very high quality finish. 'Up-Cut' or 'Down-Cut' spiral.

ØD	B	Ød	L	'Up-Cut' Tool No.	'Down-Cut' Tool No.	Price
3/8	1-1/4	1/2	3	46114	46214	\$65.49
1/2	1-1/2	1/2	3-1/2	46116	46216	\$85.09
1/2	2	1/2	4	46118	46218	\$96.11

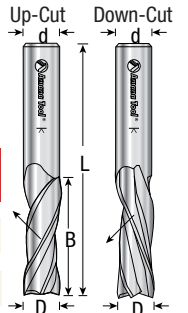

SOLID CARBIDE COMPRESSION SPIRAL FLUTE

FOR MDF/LAMINATE
Single Flute

ØD	B	Ød	L	Tool No.	Price
1/2	1-1/4	1/2	3	46159	\$86.59
1/2	1-5/8	1/2	3-1/2	46160	\$97.06
3/4	2	3/4	4	46168 *	\$128.10

ØD	B	B1 mm	Ød	L	Tool No.	Price
1/4	7/8	7	1/4	2-1/2	46170	\$44.87
1/4	7/8	7	1/4	2-1/2	46170-LH *	\$75.08
3/8	1-1/4	9	3/8	3	46172	\$100.00
3/8	1	9	1/2	3	46174	\$85.68
3/8	1-1/8	9	1/2	3	46178	\$89.46
1/2	1	9	1/2	3	46182	\$93.42
1/2	1-1/8	10	1/2	3	46186	\$97.30
1/2	1-1/4	9	1/2	3	46188	\$64.89
1/2	1-1/4	9	1/2	3	46188-LH *	\$124.67
1/2	1-1/2	12	1/2	3-1/2	46189	\$98.67
1/2	1-5/8	11	1/2	3-1/2	46190	\$78.05
1/2	1-5/8	11	1/2	3-1/2	46190-LH *	\$136.89
1/2	1-1/2	7/16"	1/2	4-1/16	46191	\$109.83
5/8	2	17	5/8	4	46194 *	\$58.07

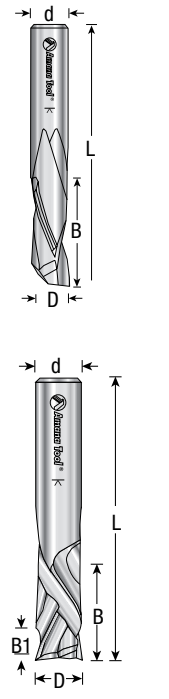

AMANA SOLID CARBIDE COMPRESSION SPIRAL FLUTE FOR MORTISING WORK

2 Flute

These tools have a much shorter up-cut section than the standard compression tools. They are ideal for mortising, grooving and dado.

ØD	B	B1	Ød	L	Tool No.	Price
1/4	1	1/8	1/4	2-1/2	46350	\$43.65
3/8	1-1/4	3/16	1/2	3	46352	\$79.00
3/8	7/8	1/8	3/8	3	46367	\$72.77
1/2	1-1/4	1/4	1/2	3	46354	\$87.33
1/2	1-5/8	1/4	1/2	3-1/2	46356	\$116.45

3 Flute

3 flute design provides an extra-smooth finish.

ØD	B	B1	Ød	L	Tool No.	Price
3/8	1	3/16	3/8	3	46020	\$72.77
1/2	1	1/4	1/2	3	46022	\$91.18
1/2	1-3/8	1/4	1/2	3-1/2	46024	\$107.84

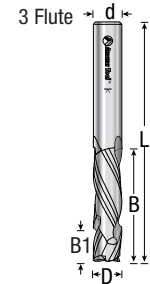
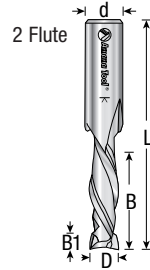

SOLID CARBIDE ACRYLIC 'O' FLUTE SLOW SPIRAL

Up-Cut & Down-Cut • 2 Flute

Provides smooth finish in acrylic materials, and both soft and hard plastics.

ØD	B	Ød	L	'Up-Cut' Tool No.	'Down-Cut' Tool No.	Price
1/4	3/4	1/4	2-1/2	46313	46413	\$52.43
1/4	1	1/4	2-1/2	46311	46411	\$59.89

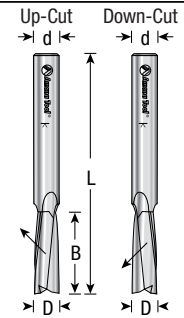

SOLID CARBIDE PLASTIC SLOW SPIRAL FLUTE PLUNGE

3 Flute

ØD	B	Ød	L	'Up-Cut' Tool No.	'Down-Cut' Tool No.	Price
3/8	1	3/8	2-1/2	—	46430	\$63.42
1/2	1	1/2	3	46332	46432	\$79.38

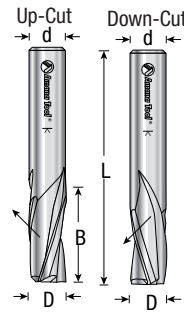

SOLID CARBIDE COMPRESSION SPIRAL FLUTE FOR MDF/LAMINATE

3 Flute Designed for an extra-smooth finish.

ØD	B	B1 mm	Ød	L	Tool No.	Price
3/8	1-1/8	9	3/8	3	46010	\$65.94
1/2	1-1/4	9	1/2	3	46012	\$107.59
1/2	1-5/8	9	1/2	3-1/2	46014	\$120.75

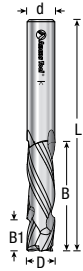

DOUBLE EDGE FOLDING 'V' GROOVE

For Shaping Composite Panels
Carbide Tipped

ØD	ØD1	a°	B	Ød	L	Tool No.	Price
1/2	0.090	45°	3/8	1/4	2	45792	\$35.74
1/2	0.090	45°	3/8	1/2	2	45794	\$35.74
23/32	—	22.5°	—	1/4	2-1/4	45798	\$54.29

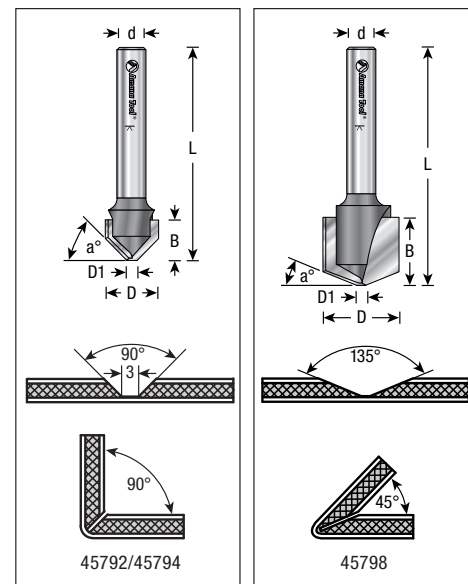

SOLID CARBIDE COMPRESSION SPIRAL FLUTE FOR SOLID WOOD

Single Flute

ØD	B	Ød	L	Tool No.	Price
1/4	7/8	1/4	2-1/2	46390	\$50.61
3/8	1-1/8	1/2	3	46392	\$98.53

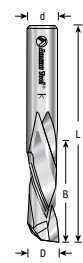

SOLID CARBIDE SPIRAL FLUTE ROUGHING With Chipbreaker

3 Flute

ØD	B	Ød	L	'Up-Cut' Tool No.	'Down-Cut' Tool No.	Price
1/2	1-5/8	1/2	3-1/2	46134	46234	\$121.42

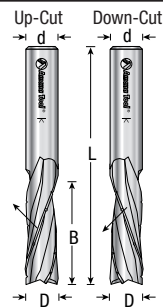

3 Flute

ØD	B	Ød	L	'Up-Cut' Tool No.	'Down-Cut' Tool No.	Price
1/2	1-5/8	1/2	3-1/2	46124	46224	\$125.76
1/2	2	1/2	4	46126	46226	\$148.47

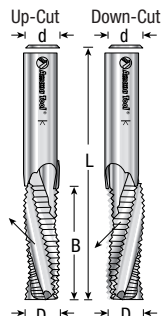

SOLID CARBIDE ROUGHING SPIRAL MULTI FLUTE FOR COMPOSITE MATERIALS*

ØD	B	Ød	L	Tool No.	Price
1/4	1	1/4	2-9/16	46133	\$59.12
1/2	1-21/32	1/2	3-1/4	46135	\$158.10

*Carbon fiber, Trespa,® fiberglass, etc.

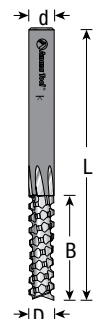

3D renderings & tool illustrations not shown at actual size.

AMANA SOLID CARBIDE FIBERGLASS ABRASIVE TYPE PLUNGE DIAMOND PATTERN

ØD	B	Ød	L	Type of Cut	Tool No.	Price
1/4	3/4	1/4	2	Fine	46110	\$24.26
1/4	3/4	1/4	2	Coarse	46112	\$24.26

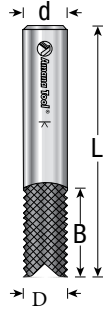

PANEL PILOT Carbide Tipped • Single Flute Heat Treated

ØD	B	Ød	L	Tool No.	Price
1/4	3/4	1/4	2-1/2	45506	\$11.45
3/8	1	1/4	2-7/8	45507	\$17.50
3/8	1	3/8	3	45508	\$12.99
1/2	1-3/16	1/2	3-5/8	45510	\$14.53
1/2	2	1/2	4-3/4	45511	\$25.34

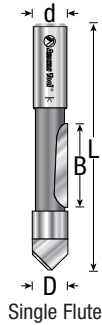

INVECTRA™ METAL LAMINATE TRIM BITS

SOLID CARBIDE METAL LAMINATE TRIM 2 Flute • Industry Recommended

Designed and tested for trimming all decorative metal laminates manufactured by Formica®, Advanced Technology Inc. (ATI™), DecoMetal® and many others. Engineered from an Amana Tool® exclusive carbide grade designed specifically for cutting both metal laminates and wood-based substrate materials. Each bit is fitted with a steel bearing guide that enables users to trim laminate materials flush to the substrate, allowing you to perform any metal trim job to perfection!

ØD	B	Ød	L	Tool No.	Price
1/2	5/8	1/4	2-3/8	51430* Δ_{28}	\$63.28
1/2	5/8	1/2	3-1/2	51432* Δ_{14}	\$107.31

* Except material: Formica® #2178

With Invectra™ router bits, kitchen fabricators, remodelers and construction workers can perform any kind of cut and trim job in metal laminates.

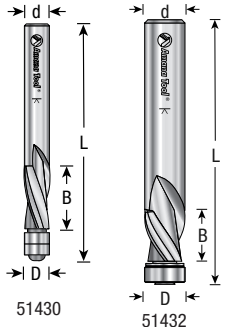

SOLID CARBIDE ALUMINUM CUTTING FLUSH TRIM SPIRAL

2 Flute With Ball Bearing Guide

ØD	B	Ød	L	Cut		Price
				'Up-Cut'	'Down-Cut'	
Tool No.	Tool No.					
1/4	1-1/4	1/4	3-5/16	51420	51520	\$80.29
1/4	1/2	1/4	2-1/2	51422	51522	\$77.77

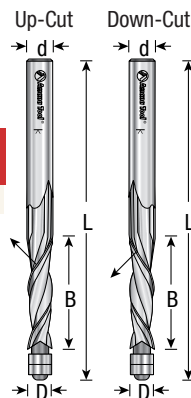

3D renderings & tool illustrations not shown at actual size.

MORTISING Carbide Tipped • 2 Flute

ØD	B	Ød	L	Tool No.	Price
1/2	3/4	1/4	2	45500	\$14.32
5/8	3/4	1/4	2	45502	\$16.59
3/4	3/4	1/4	2	45504	\$17.61
1-1/4	3/4	1/2	2-1/8	45505	\$28.91



NOTE:
A proper mortising bit, as shown, should have a large gullet between the two flutes, as indicated with an arrow. This allows greater chip clearance and removal.

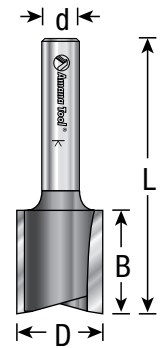

MORTISING BIT For Bottom Cleaning Carbide Tipped • 2 Flute Up-Shear Design

ØD	B	Ød	L	Tool No.	Price
3/4	7/16	1/4	2-1/4	45560	\$32.24
3/4	7/16	1/2	2-1/2	45562	\$32.24
1	7/16	1/2	2-1/2	45564	\$34.23
1-1/2	5/8	1/2	2-3/4	45566	\$50.26

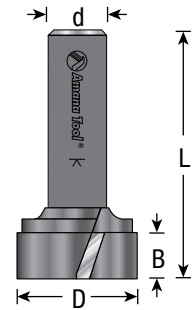

UP-SHEAR BIT SLOT MORTISER Carbide Tipped • 2 Flute

For use in lock mortising machines and door machines.

ØD	B	B1	Ød	L	Tool No.	Price
1/2	1	2-3/4	1/2	6	45540 Δ	\$47.67
5/8	1	4-3/4	1/2	6-5/8	45542 Δ	\$52.96
3/4	1	4-3/4	1/2	6-5/8	45544 Δ	\$58.24

Warning: DO NOT USE THESE BITS ON A DRILL PRESS MACHINE UNDER ANY CIRCUMSTANCES!

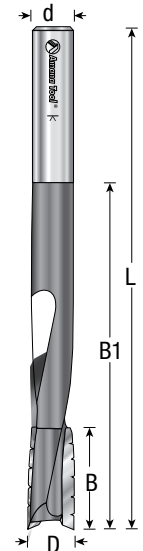

INSERT CARBIDE FLUSH TRIM TEMPLATE With Upper Ball Bearing

2 Flute

Insert carbide is the economical way to go. Each knife has two edges; saves down time. We have three different grades of carbide for various applications, such as: hard/softwood, MDF, solid surface, chipboard and plywood.

ØD	B	Ød	L	Replacement		Price
				Knives	Tool No.	
3/4	30mm	1/2	3-1/4	RCK-30	RC-1230	\$94.43
3/4	50mm	1/2	3-15/16	RCK-151	RC-2400**	\$110.08

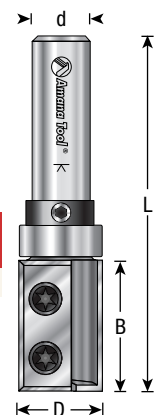

AMANA FLUSH TRIM PLUNGE TEMPLATE

With Upper Ball Bearing
Carbide Tipped • 2 Flute

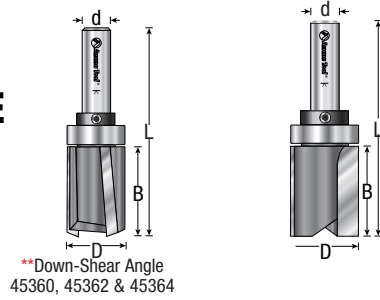

1/4" Shank

ØD	B	Ød	L	Replacement		Tool No.	Price
				Bearing	Collar		
3/8	1/2	1/4	2	47751(2)	47764	45475 †	\$19.81
1/2	1	1/4	2-1/2	47701	47724	45460	\$24.33
1/2	1-1/4	1/4	2-3/4	47701	47724	45461	\$32.59
5/8	1/2	1/4	2-1/4	47712	47724	45482	\$27.09
5/8	1	1/4	2-3/4	47712	47724	45462	\$25.27
3/4	1	1/4	2-1/2	47714	47724	45464	\$26.67

3/8" Shank

ØD	B	Ød	L	Replacement		Tool No.	Price
				Bearing	Collar		
1	1	3/8	2-7/8	47722	47730	45466	\$39.03

1/2" Shank

ØD	B	Ød	L	Replacement		Tool No.	Price
				Bearing	Collar		
3/4	1	1/2	3	47721	47739	45463	\$37.56
3/4	1-1/2	1/2	3-1/2	47721	47739	45362	\$40.18
3/4	1-3/4	1/2	3-3/4	47721	47739	45465	\$50.16
1	1-3/4	1/2	3-3/4	47754	47739	45467	\$56.98
1-1/8	1	1/2	3	47738	47740	45550	\$58.21
1-1/8	1-1/2	1/2	3-1/2	47738	47740	45468	\$56.11
1-1/8	2	1/2	4	47738	47740	45551	\$68.95

INSERT CARBIDE FLUSH TRIM

2 Flute With Ball Bearing Guide

ØD	B	Ød	L	Repl. Knives	Tool No.	Price
3/4	12mm	1/4	2-1/8	AMA-12	RC-1000	\$73.15
3/4	30mm	1/2	3-1/4	ICK-30	RC-1004	\$84.35
3/4	50mm	1/2	4-5/16	RCK-151	RC-1006*	\$133.53

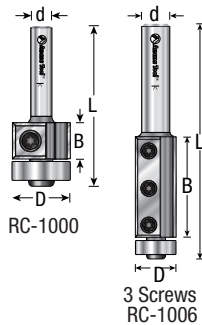

NO-FILE™ With Ball Bearing Guide

Carbide Tipped • 2 Flute

ØD	B	R	Ød	L	Tool No.	Price
1/2	3/8	.059 (1.5mm)	1/4	1-7/8	47150	\$25.34
1/2	3/8	.059 (1.5mm)	1/2	2-1/8	47152	\$25.94
1/2	3/8	.015 (0.4mm)	1/4	1-7/8	47154	\$24.75

NOTE: #47154 is for laminates .025"-.038" thick (.4mm radius),
#s 47150-47152 are for laminates .042"-.052" thick (1.5mm radius).
Replacement bearing #47704 (3/8" dia.).

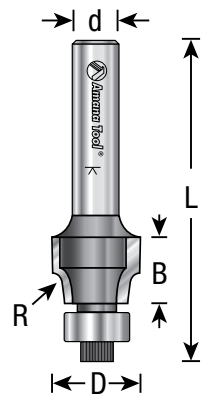

3D renderings & tool illustrations not shown at actual size.

FLUSH TRIM

With Ball Bearing Guide

Carbide Tipped
2 Flute

ØD	B	Ød	L	Tool No.	Price
1/4	1/2	1/4	2-1/4	47090 *	\$22.58
1/4	1	1/4	2-1/2	47092 *	\$23.49
3/8	1	1/4	2-5/8	47100	\$15.72
1/2	8mm(5/16)	1/4	2-1/4	RC-2000	\$42.39
1/2	7/16	1/4	2-19/64	DRB-400	\$89.97
1/2	1	1/4	2-5/8	47104	\$15.37
1/2	1/2	1/4	2-1/4	47106	\$15.05
1/2	1	1/2	3-1/4	47108	\$16.56

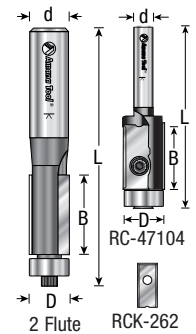

3 Flute

For an extremely smooth finish, choose the three-flute configuration. It is especially good to use on laminates that tend to chip easily.

ØD	B	Ød	L	Tool No.	Price
1/2	1	1/4	2-5/8	47114	\$20.83
1/2	1/2	1/4	2	47116	\$20.69
1/2	1	1/2	3-1/4	47118	\$22.75

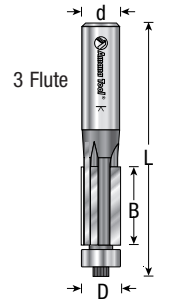

4 Flute

For a super-smooth cut finish, use a four-flute bit. Feed rate is reduced, and chipping is virtually eliminated.

ØD	B	Ød	L	Tool No.	Price
3/4	1	1/2	3	57184	\$48.37
3/4	1-1/2	1/2	4	57185	\$47.81
3/4	2	1/2	4-1/2	57186	\$60.76
3/4	2	1/2	4-3/4	57187 **	\$73.26

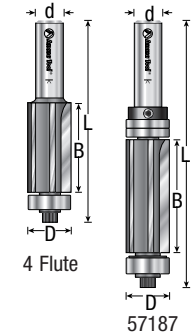

FLUSH TRIM (EXTRA LONG)

With Ball Bearing Guide
Carbide Tipped • 2 Flute

ØD	B	Ød	L	Tool No.	Price
1/2	1-1/2	1/2	3-7/8	47124	\$25.27
1/2	2	1/2	4-1/4	47126	\$27.51
1/2	2	1/2	4-3/8	47126-2 ••	\$48.37

Carbide Tipped • 3 Flute

ØD	B	Ød	L	Tool No.	Price
1/2	1-1/2	1/2	3-7/8	47128	\$33.53

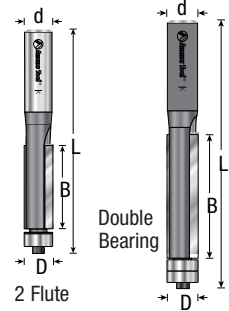

DYNABIT™ LAMINATE TRIM

With Ball Bearing Guide

Carbide Tipped • 2 Flute

ØD	B	Ød	L	Type	Repl. Bearing	Tool No.	Price
1/2	1	1/4	2-5/8	Down-shear	47706	47105	\$17.26
1/2	1	1/2	3	Down-shear	47706	47109	\$17.71
1/2	1	1/4	2-7/8	Down-shear	47706	47111	\$19.32
1/2	1	1/2	3-1/4	Down-shear	47706	47113	\$19.32
5/8	5/8	1/4	2	Flush Helix	47712	47180	\$21.74
3/4	5/8	1/4	2-1/4	Flush Helix	47714	47182	\$23.07
3/4	3/8	1/4	2	15° Bevel	47714	47184	\$23.80

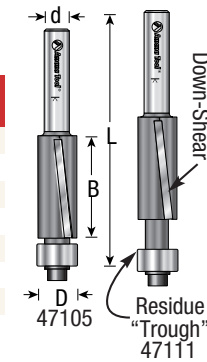

AMANA
SUPERTRIM™ 3° UP-SHEAR
With Ball Bearing Guide

Carbide Tipped • 2 Flute

ØD	a°	B	Ød	L	Type	Tool No.	Price
3/4	3°	1-1/2	1/2	3-7/8	Up-shear	47130	\$31.61
3/4	3°	2	1/2	4-1/4	Up-shear	47134	\$34.69
3/4	3°	1	1/2	3	Down-shear	47135	\$31.05
3/4	3°	1-1/2	1/2	3-7/8	Down-shear	47136	\$31.19
3/4	3°	2	1/2	4-1/4	Down-shear	47138	\$33.15

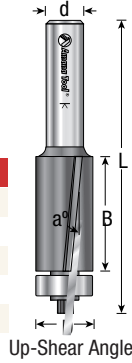

SOLID CARBIDE COMPRESSION SPIRAL
2 Flute With Double Ball Bearing Guides

ØD	B	Ød	L	Tool No.	Price
1/2	1-1/4	1/2	3-3/4	46192	\$148.72

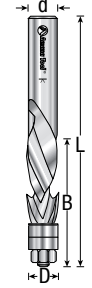

DOWN-SHEAR MULTI TRIMMER

Carbide Tipped • 2 Flute

ØD	B	Ød	L	Replacement Bearing		Tool No.	Price
				Upper	Lower		
3/4	1-1/4	1/2	3-3/4	47721(2)	47714	47096	\$38.78
3/4	2	1/2	4-5/16	47721(2)	47714	47097	\$49.84

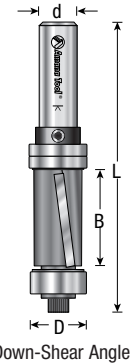

'OVERHANG' TRIM
With Ball Bearing Guide

Carbide Tipped • 2 Flute

ØD	B	A	Ød	L	Tool No.	Price
3/8	1/2	1/8	1/4	2	47190	\$20.44
1/2	1/2	1/16	1/4	2	47192	\$19.92

Replacement bearing: #47718 (5/8" diameter).

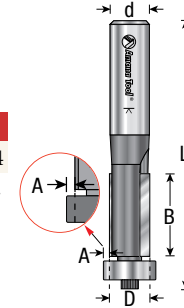

ULTRATRIM™
SOLID CARBIDE SPIRAL TRIM
2 Flute With Double Ball Bearing Guides

ØD	B	Ød	L	'Up-Cut'	'Down-Cut'	Price
				Tool No.	Tool No.	
1/2	1-1/4	1/2	3-3/4	46300	46400	\$129.61
1/2	2	1/2	4-3/4	46304	46404	\$148.89

Standard Replacement Bearing: (.500" dia.), use #47706.
Undersized bearing (.492" dia.), use #47715 – for use after re-sharpening. Replacement nut: use #67086.

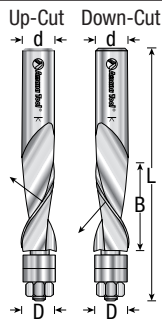

FLUSH TRIM 'V' GROOVE
With Ball Bearing Guide

Carbide Tipped • 2 Flute

ØD	ØD1	B	Ød	L	Tool No.	Price
5/8	1/2	1	1/4	2-5/8	47160	\$27.51
5/8	1/2	1	1/2	3-1/4	47162	\$29.54

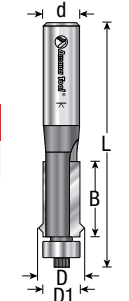

ULTRATRIM™
SOLID CARBIDE SPIRAL TRIM

2 Flute • Up-Cut Or Down-Cut Spiral

Spiral flush trim bit, #46196 is used for acrylic and wood (such as MDF) up to a 1/4" thick, for getting into tight corners with a small radius and great for cleaning out your edges. #46197 is mainly used for acrylic and wood (such as MDF) up to a 1/2" thickness.

ØD	B	Ød	L	'Up-Cut'	'Down-Cut'	Price
				Tool No.	Tool No.	
1/8	3/8	1/4	2	46196*+	46296*+	\$58.07
1/4	1	1/4	3	46197♦	46297♦	\$64.58

* NOTE: Due to extremely small cutting diameter this bit is not guaranteed.

+ Brass pilot guide
♦ Double ball bearing pressed

Replacement Bearings for #46197 and #46297:
Two #47723. Philips Retaining Screws for #46197 and #46297: #67134.

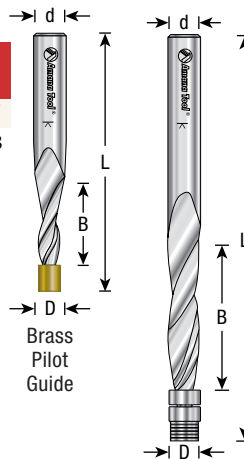

BEVEL TRIM
With Ball Bearing Guide

Carbide Tipped • 2 Flute

ØD	a°	B	Ød	L	Tool No.	Price
5/8	15°	9/32	1/4	1-7/8	47200	\$18.59
23/32	25°	9/32	1/4	1-7/8	47202	\$19.01
3/4	25°	7/16	1/4	1-7/8	47206	\$22.19
1-1/16	45°	9/32	1/4	2	47204	\$22.19

Carbide Tipped • 3 Flute

ØD	a°	B	Ød	L	Tool No.	Price
3/4	7°	7/16	1/4	2	47302	\$25.48
51/64	15°	7/16	1/4	2	47301	\$24.78
15/16	22°	7/16	1/4	1-7/8	47300	\$24.01
1-3/32	30°	7/16	1/4	2	47304	\$25.83

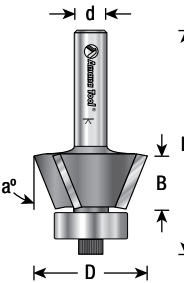
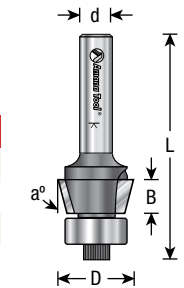

INSERT CARBIDE BEVEL TRIM™
2 Flute With Ball Bearing Guide

ØD	a°	B	Ød	L	Repl. Knives	Tool No.	Price
13/16	15°	7/16	1/4	2-1/4	AMA-12	RC-1008	\$84.35
31/32	25°	7/16	1/4	2-1/4	AMA-12	RC-1010	\$84.35
1-1/16	45°	7/16	1/4	2-1/4	AMA-12	RC-1014	\$84.35

Note: All bevel trim bits have four cutting edges per knife.

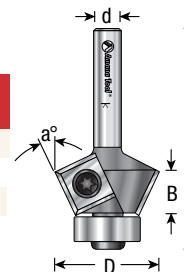

3D renderings & tool illustrations not shown at actual size.

AMANA

SOLID CARBIDE PANEL PILOT

Single Flute

ØD	B	Ød	L	Type of Cut	Tool No.	Price
1/4	1/4	1/4	1-1/2	Flush	51200	\$10.50
1/4	1/4	1/4	1-1/2	7°	51202	\$10.50
1/4	1/4	1/4	1-7/16	Flush	51204 *	\$10.50
1/4	3/8	1/4	1-1/2	Flush	51206	\$11.83

* Note: #51204 has a short/flat pilot for dado clean out/ dado cleaning.

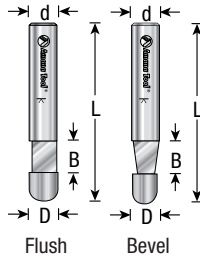

INSERT CARBIDE SPOILBOARD SURFACING & RABBETING

2 Wing

ØD	B	Ød	L	Repl. Knives	Tool No.	Price
2-1/2	1/2	1/2	2-1/2	HMA-12	RC-2257	\$215.46
4	1/2	3/4	4	HMA-12	RC-2258 *	\$345.33

* CNC Use Only.

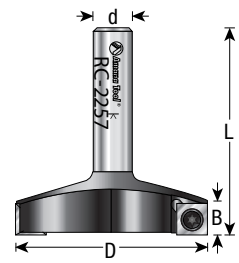

SOLID CARBIDE HOLE AND FLUSH CUT TRIMMER

Single Flute

ØD	B	Ød	L	Tool No.	Price
1/4	1/4	1/4	1-1/2	51712	\$13.79

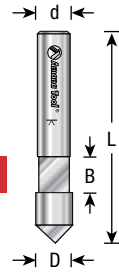

SOLID CARBIDE 'V' GROOVING

Single Flute

ØD	B	Ød	L	Tool No.	Price
1/4	3/8	1/4	1-1/2	51710	\$14.04

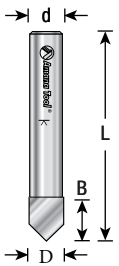

COMBINATION BEVEL AND FLUSH TRIM

Carbide Tipped

ØD	a°	B	Flutes	Ød	L	Tool No.	Price
1/2	23°	1/2	2	1/4	1-3/4	51100	\$14.00
13/32	22°	9/32	2	1/4	15/16	51600 *	\$14.95

* Bevel Trim Only.

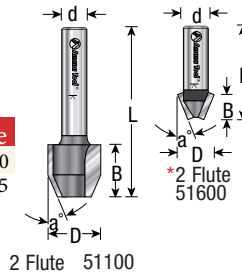

CNC INSERT CARBIDE SPOILBOARD SURFACING & RABBETING

With Scorer and 2+2 Insert Knife Design

ØD	B	Ød	L	Repl. T.C. Knives	Max RPM	Tool No.	Price
80mm(3-1/8)	12mm(15/32)	3/4	90(3-1/2)	AMA-12, RCK-70	18,000	RC-2252	\$247.62

The CNC insert spoilboard industrial router bits with scorers features a unique 2+2 knife design that contains two cutting flutes and two up-shear scorers, which provide a smoother finish at the bottom of the cut than traditional two-knife style router bits. Engineered with an Amana-exclusive carbide grade for the highest quality of cut, maximum cutting efficiency, faster material removal process and the longest tool life. These industrial router bits feature insert knives with four cutting edges that allow users to flip the knife over when one side becomes dull.

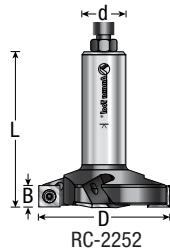

'V' GROOVE

Carbide Tipped • 2 Flute

ØD	a°	B	B1	Ød	L	Tool No.	Price
1/2	60°	5/8	7/16	1/4	1-3/4	45705	\$27.27
3/8	90°	7/16	3/16	1/4	1-5/8	45700	\$21.74
3/8	90°	7/16	3/16	1/2	2	45702	\$21.77
1/2	90°	1/2	1/4	1/4	1-5/8	45704	\$24.19
3/4	90°	5/8	3/8	1/4	1-3/4	45714	\$39.83
3/4	90°	5/8	3/8	1/2	2-1/8	45716	\$41.48
7/8	90°	5/8	7/16	1/4	1-7/8	45718	\$49.32
1	90°	5/8	1/2	1/4	1-7/8	45722	\$51.35
1	90°	5/8	1/2	1/2	2-1/4	45724	\$52.61
1-1/4	90°	3/4	5/8	1/2	2-1/2	45726	\$56.56
1-1/4	90°	15/16	5/8	1/4	2-13/64	45751	\$56.56
1-1/4	100°	53/64	17/32	1/4	2-3/32	45752	\$64.02
1-1/4	110°	47/64	7/16	1/4	2	45754	\$63.67
1-1/4	120°	21/32	23/64	1/4	1-59/64	45756	\$63.67
1-1/4	130°	31/64	13/64	1/4	1-3/4	45758	\$55.44
1-1/4	150°	7/16	11/64	1/4	1-11/16	45770	\$58.21
1-1/2	90°	1	3/4	1/2	2-3/4	45728	\$61.04
2	90°	1-3/4	1	1/2	3-1/4	45732	\$121.84
1-1/2	90°	1	3/4	1/2	2-3/4	45728-CNC	\$64.75
2	90°	1-3/4	1	1/2	3-1/4	45732-CNC	\$145.50

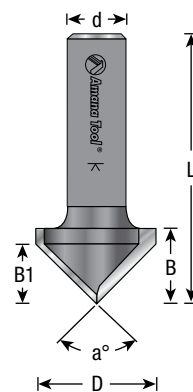
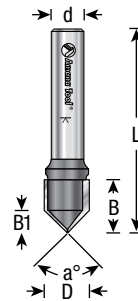

3D renderings & tool illustrations not shown at actual size.

AMANA

INSERT CARBIDE 'V' GROOVE, MITER FOLD, SIGNMAKING & LETTERING

40° to 160° • Single Flute & 2 Flute
1/2" Shank

ØD	a°	a°1	B	B1	Flutes	Cutting Edges	Ød	L1	L	Gen. Purpose Repl.T.C Knife	MDF Repl.T.C Knife	Torx Screw	Tool No.	Price
47/64	40°	20°	1	1- 1/16	1	1	1/2	1-1/2	2-9/16	RCK-57	RCK-367	67117	RC-1040	\$112.81
13/16	45°	22.5°	1	1- 1/16	1	1	1/2	1-3/8	2-3/8	RCK-56	RCK-350	67117	RC-1045	\$66.69
13/16	45°	22.5°	1	1- 1/16	1	1	1/2	2-1/2	3-21/32	RCK-56	RCK-350	67108	RC-1049	\$85.60
27/32	46°	23°	63/64	1- 1/16	1	1	1/2	1-3/8	2-3/8	RCK-56	RCK-350	67117	RC-1047	\$66.69
1-1/32	60°	30°	29/32	1- 1/16	1	1	1/2	1-3/8	2-7/16	RCK-56	RCK-350	67117	RC-1108	\$67.69
1-7/32	70°	35°	7/8	1- 1/16	1	1	1/2	1-1/2	2-9/16	RCK-56	RCK-350	67117	RC-1048	\$70.40
1-1/4	72°	36°	7/8	1- 1/16	1	1	1/2	1-1/2	2-19/32	RCK-56	RCK-350	67117	RC-1072	\$72.20
1-1/2	90°	45°	3/4	1- 1/16	1	2	1/2	1- 25/32	3	RCK-134	RCK-351	67117	RC-1102	\$111.10
1-1/2	91°	45.5°	3/4	1- 1/16	1	2	1/2	1- 25/32	3	RCK-119	RCK-352	67115	RC-1100	\$111.10
1-3/4	110°	55°	5/8	1- 1/16	1	2	1/2	2	3-3/16	RCK-119	RCK-352	67117	RC-1105	\$122.69
2-1/32	120°	60°	9/16	1-5/32	2	1	1/2	2	3-1/16	RCK-136	RCK-353	67139	RC-1104	\$150.15
2-1/8	130°	65°	1/2	1-5/32	2	1	1/2	2	3	RCK-137	RCK-354	67115	RC-1107	\$155.28
2-1/4	150°	75°	19/64	1-5/32	2	1	1/2	2	2-15/16	RCK-137	RCK-354	67115	RC-1106	\$157.94
2-5/16	160°	80°	13/64	1-5/32	2	1	1/2	2	2-25/32	RCK-137	RCK-354	67115	RC-1109	\$164.73

INSERT CARBIDE 'V' GROOVE, MITER FOLD, SIGNMAKING & LETTERING

45° to 150° • Single Flute & 2 Flute
3/4" Shank

ØD	a°	a°1	B	B1	Flutes	Cutting Edges	Ød	L1	L	Gen. Purpose Repl.T.C Knife	MDF Repl.T.C Knife	Torx Screw	Tool No.	Price
1-1/2	45°	22.5°	1-3/4	1-15/16	1	1	3/4	2-3/16	4-1/4	RCK-58	RCK-349	67108	RC-1031	\$119.51
2-5/8	90°	45°	1-9/32	1-27/32	1	2	3/4	2-5/32	3-13/16	RCK-133	RCK-355	67110	RC-1030	\$172.00
3	90°	45°	1-1/2	27/64	1	2	3/4	2-23/64	4-23/64	RCK-138	RCK-359	67115	RC-1034	\$194.18
2-5/8	91°	45.5°	1-5/16	1-3/8	1	2	3/4	2-3/8	3-7/8	RCK-117	RCK-356	67110	RC-1028	\$158.27
3-27/32	130°	65°	13/16	1-31/32	2	1	3/4	2-3/8	3-7/8	RCK-112	RCK-357	67115	RC-1025	\$131.24
3-25/32	150°	75°	1/2	1-31/32	2	1	3/4	2-3/8	3-1/2	RCK-112	RCK-357	67115	RC-1027	\$174.99

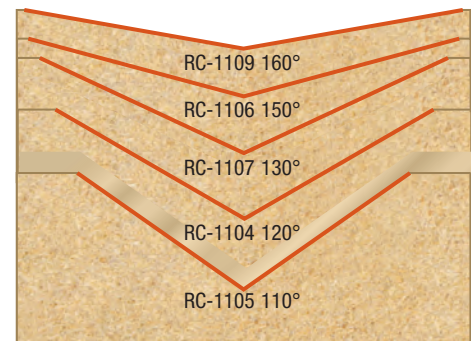
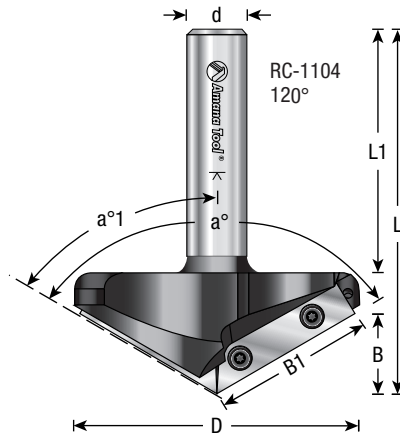
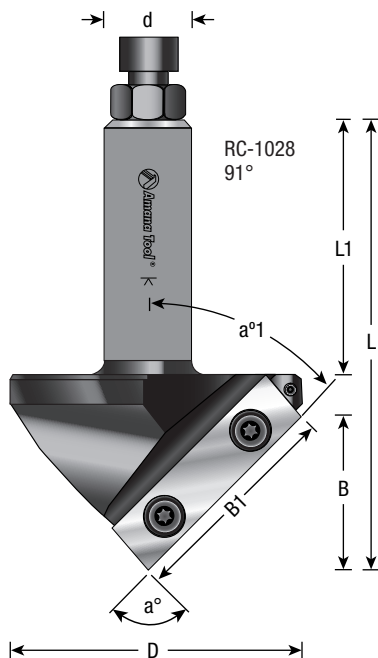

3D renderings & tool illustrations not shown at actual size.

AMANA

CNC INSERT CARBIDE ENGRAVING SYSTEM SETS

Description	Ød	L	Tool No.	Price
8-Piece In-Groove Set	1/4	2-1/2	AMS-210	\$174.23
8-Piece In-Groove Set	1/2	2-1/2	AMS-209	\$174.23

Knives Included with Each Set

QTY	Description
1	Corner Round/Bead Groove Insert Carbide Knife
1	Straight Insert Carbide Knife
3	30° V-Tip Insert Carbide Knives
1	60° V-Tip Insert Carbide Knife
1	1/16" Radius Core Box Insert Carbide Knife

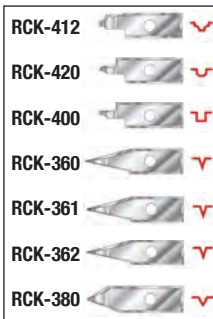

SOLID CARBIDE SIGNMAKING AND LETTERING CUTTING HEAD

ØD	a°	B	Flute	B1	Ød	L	Tool No.	Price
9/16	60°	1/2	3	7/16	1/4	2-1/4	45730	\$64.79
9/16	60°	1/2	3	7/16	1/2	2-1/4	45733	\$64.79
9/16	60°	1/2	1	7/16	1/4	2-1/2	45731	\$72.80

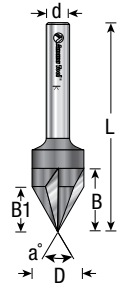

SOLID CARBIDE CARVING/ENGRAVING

2 Flute

ØD	a°	B	Ød	L	Tool No.	Price
3/16	82.5°	1/2	1/4	1-5/8	45780	\$20.34
1/4	60°	3/16	1/4	1-1/2	45782	\$19.60

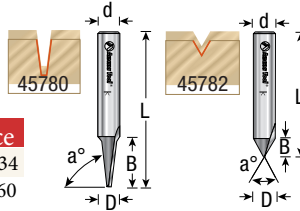

SOLID CARBIDE 30° ENGRAVING

For Signmaking Single Flute

t = tip width	Ød	L	Tool No.	Price
0.005	1/4	2	45771	\$27.83
0.005 to 0.090	30° Set (7 Pcs.)	2	45779	\$174.69

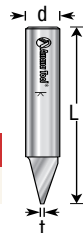

CORE BOX & 'V' GROOVE

With Upper Ball Bearing

Carbide Tipped • 2 Flute

ØD	a°	R	B	Ød	L	Type	Tool No.	Price
1/2	90°	—	1/2	1/4	2	'V' Groove	45750	\$33.81
1/2	—	1/4	3/8	1/4	2	Core Box	45950	\$32.90

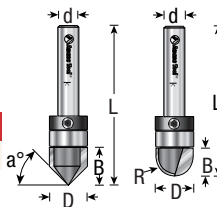

LETTERING 60° ANGLE

Carbide Tipped • 2 Flute

ØD	a°	B	Ød	L	Tool No.	Price
1-1/8	60°	3/4	1/2	2-3/4	45788	\$93.00
1-1/8	60°	3/4	1/2	2-3/4	45789	\$102.27

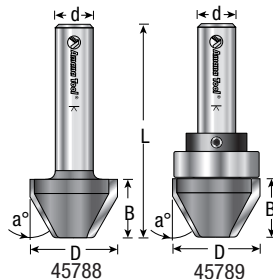

SIGNMAKING, LETTERING AND ENGRAVING

2 Flute

Description	Ød	L	Tool No.	Price
Tool Body	1/4	2-1/2	RC-1075	\$54.20
Tool Body	1/2	2-1/2	RC-1076	\$54.20

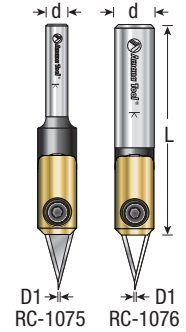

Replacement In-Groove™ Insert Carbide Knives

30° V-TIPS

7 Sizes Available

ØD1	B	Tool No.	Price
0.005	16mm(5/8)	RCK-360	\$23.99
0.010	16mm(5/8)	RCK-361	\$23.99
0.020	16mm(5/8)	RCK-362	\$23.99
0.030	16mm(5/8)	RCK-363	\$23.99
0.040	16mm(5/8)	RCK-364	\$23.99
0.060	16mm(5/8)	RCK-366	\$23.99
0.090	16mm(5/8)	RCK-369	\$23.99

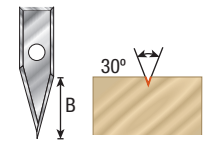

60° V-TIPS

7 Sizes Available

ØD1	B	Tool No.	Price
0.005	7.5mm(9/32)	RCK-380	\$23.04
0.010	7.5mm(9/32)	RCK-381	\$23.04
0.020	7.5mm(9/32)	RCK-382	\$23.04
0.030	7.5mm(9/32)	RCK-383	\$23.04
0.040	7.5mm(9/32)	RCK-384	\$23.04
0.060	7.5mm(9/32)	RCK-385	\$23.04
0.090	7.5mm(9/32)	RCK-386	\$23.04

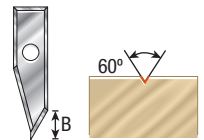

90° V-TIPS

4 Sizes Available

ØD1	B	Tool No.	Price
0.005	4mm(5/32)	RCK-390	\$23.04
0.010	4mm(5/32)	RCK-391	\$23.04
0.020	4mm(5/32)	RCK-392	\$23.04
0.040	4mm(5/32)	RCK-393	\$23.04

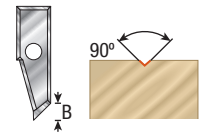

STRAIGHT PLUNGE

4 Sizes Available

ØD1	B	Tool No.	Price
1/8	5mm(3/16)	RCK-400	\$23.04
3/16	6mm(15/64)	RCK-402	\$23.04
1/4	7mm(9/32)	RCK-404	\$23.04
5/16	8mm(5/16)	RCK-406	\$23.04

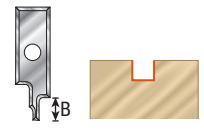

CORE BOX

4 Sizes Available

ØD1	B	Tool No.	Price
1/16	5mm(3/16)	RCK-420	\$23.04
3/32	6mm(15/64)	RCK-422	\$23.04
1/8	7mm(9/32)	RCK-424	\$23.04
5/32	8mm(5/16)	RCK-426	\$23.04

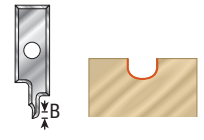

CORNER ROUND

3 Sizes Available

ØD1	B	Tool No.	Price
1/16	8mm(5/16)	RCK-410	\$23.04
3/32	8mm(5/16)	RCK-412	\$23.04
1/8	8mm(5/16)	RCK-414	\$23.04

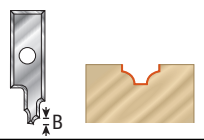

3D renderings & tool illustrations not shown at actual size.

AMANA MINIATURE WITH 3/16" BALL BEARING GUIDES *Reach Tighter Corners Without Burn Marks!*

Carbide Tipped

ØD	ØD1	R	a°	B	A	Ød	L	Description	Tool No.	Price
7/16	3/16	—	—	1/2	1/8	1/4	1-7/8	Rabbet	MR0100	\$21.18
3/16	3/16	—	—	7/16	—	1/4	2	Flush Trim	MR0102	\$19.50
9/16	3/16	3/32	—	5/16	—	1/4	1-7/8	Roman Ogee	MR0104	\$27.83
1/4	3/16	—	7°	3/8	—	1/4	1-7/8	Bevel Trim	MR0106	\$21.98
9/16	3/16	—	45°	1/4	—	1/4	1-7/8	Bevel Trim	MR0108	\$23.03
3/8	3/16	3/32	—	3/8	—	1/4	1-13/16	Corner Rounding	MR0110	\$26.25
7/16	3/16	1/8	—	3/8	—	1/4	1-13/16	Corner Rounding	MR0112	\$26.25
1/2	3/16	5/32	—	3/8	—	1/4	1-13/16	Corner Rounding	MR0114	\$27.02

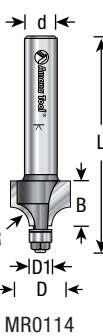
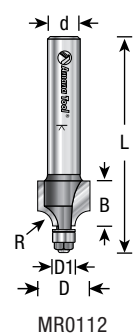
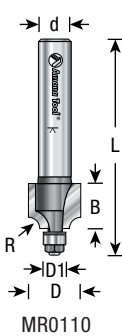
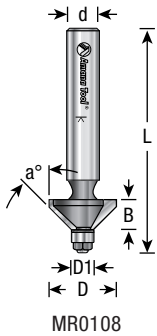
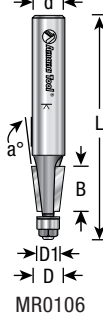
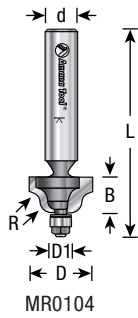
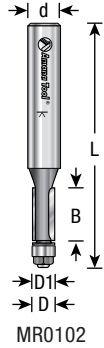
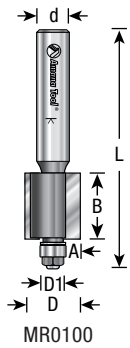

T-SLOT

Carbide Tipped • 2 Flute

Edge Type	ØD	ØD1	R	a°	a1°	B	B1	Ød	L	Tool No.	Price
Straight	1-1/8	3/8	—	—	—	13/16	5/16	1/2	2-1/2	45660	\$50.51
Radius	1-1/8	3/8	1/4	—	—	13/16	5/16	1/2	2-1/2	45666	\$56.49
Straight	1-1/8	1/2	—	—	—	7/8	3/8	1/2	2-1/2	45662	\$59.43
Radius	1-3/8	1/2	1/4	—	—	7/8	3/8	1/2	2-1/2	45667	\$71.05
Radius	1-13/64	13/32	1/16	—	—	43/64	23/64	1/2	2-13/32	45661	\$50.16
Bevel	1-3/8	3/8	—	30°	15°	35/64	1/4	1/2	2-3/64	45671	\$49.49

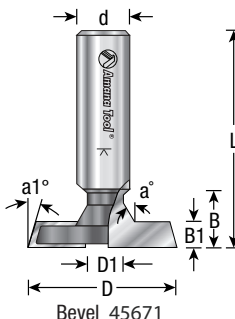
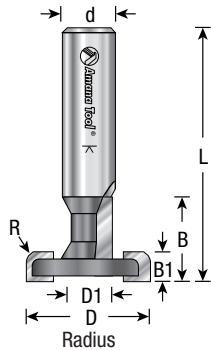
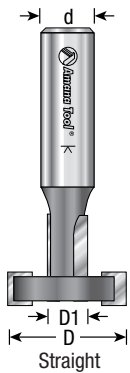

3D renderings & tool illustrations not shown at actual size.

DIAMOND TIPPED (PCD) 'T' SLOT

'T' Slot diamond tipped router (standard 'T' slot). Use with particleboard MDF, both raw or with melamine, veneer, hardwood, etc. Re-sharpen one to two times.

ØD	B	D1	# of blades	B1	Ød	L	Tool No.	Price
1-3/8	1/4	3/8	2+1	1/16	1/2	2-3/8	DRB-300-RH	\$246.95

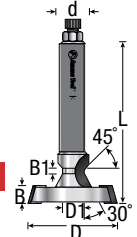

SPECIAL AMEROCK® HINGE

Carbide Tipped • 2 Flute

ØD	ØD1	R	B	B1	Ød	L	Tool No.	Price
1-1/8	3/8	5/64	21/32	5/32	3/8	2	48100	\$27.51
1-1/8	3/8	5/64	21/32	5/32	1/2	2-1/8	48101	\$27.51
1-19/32	3/8	5/64	21/32	5/32	3/8	2	48102	\$29.71

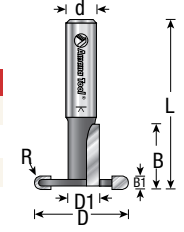

KEYHOLE

Carbide Tipped • Single Flute

ØD	ØD1	B	B1	Ød	L	Tool No.	Price
3/8	13/64	3/8	3/16	1/4	1-1/2	45650	\$19.85
1/2	5/16	3/8	3/16	1/4	1-1/2	45652	\$21.81

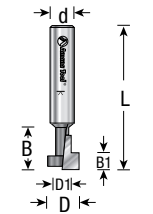

BOWL & TRAY

Carbide Tipped • 2 Flute

ØD	R	B	Ød	L	Tool No.	Price
1/2	1/8	1/2	1/4	2-1/8	45981	\$33.57
3/4	1/4	5/8	1/4	2-5/8	45982	\$33.78
3/4	1/4	5/8	1/2	2-5/8	45984	\$33.78
1-1/8	1/4	5/8	1/2	2-5/8	45986	\$47.57

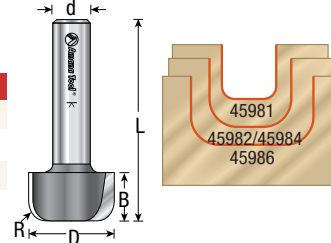

BOWL & TRAY

With Upper Ball Bearing Guide

Carbide Tipped • 2 Flute

ØD	R	B	Ød	L	Replacement		Tool No.	Price
					Bearing	Collar		
1/2	1/8	1/2	1/4	2-1/8	47701	47724	45983	\$39.97
3/4	1/4	5/8	1/4	2	47714	47724	45988	\$42.04
3/4	1/4	5/8	1/2	2-5/8	47721	47739	45990	\$42.04
1-1/8	1/4	5/8	1/2	2-5/8	47738	47740	45992	\$55.37

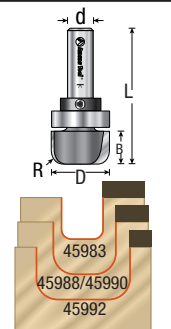

BALL END

Carbide Tipped • 2 Flute

ØD	ØD1	R	B	Ød	L	Tool No.	Price
1/2	1/4	1/4	7/16	1/2	2-1/4	45960	\$26.60
5/8	9/32	5/16	9/16	1/2	2-3/8	45962	\$30.31
3/4	5/16	3/8	11/16	1/2	2-1/2	45964	\$36.89
1	11/32	1/2	15/16	1/2	2-3/4	45968	\$45.26

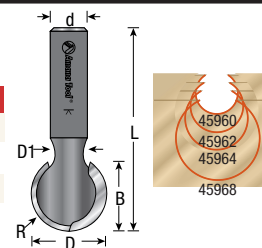

INSERT CARBIDE BALL END

Single Flute

ØD	ØD1	B	R	Ød	L	Repl. T.C.		Tool No.	Price
						Screw#	Knife		
5/8	17/32	35/64	5/16	1/2	2-3/4	67117	RCK-52	RC-1122	\$63.41

2 Flute

3/4	19/32	21/32	3/8	1/2	2-5/8	67112	RCK-53	RC-1124	\$65.98
1	43/64	15/16	1/2	1/2	2-7/8	67115	RCK-54	RC-1126	\$65.98



AMANA CORE BOX

Carbide Tipped • 2 Flute

ØD	R	B	Ød	L	Tool No.	Price
1/8	1/16	3/8	1/4	1-3/4	45900	\$20.65
3/16	3/32	1/2	1/4	1-3/4	45902	\$20.65
1/4	1/8	1/4	1/4	1-5/8	45904	\$20.34
3/8	3/16	1/4	1/4	1-1/2	45906	\$23.03
3/8	3/16	1/4	1/2	2	45908	\$27.02
1/2	1/4	3/8	1/4	1-1/2	45910	\$23.66
1/2	1/4	3/8	1/2	2-1/8	45912	\$28.63
5/8	5/16	7/16	1/4	1-5/8	45914	\$24.22
5/8	5/16	7/16	1/2	2	45916	\$32.17
3/4	3/8	7/16	1/4	1-3/4	45918	\$25.27
3/4	3/8	7/16	1/2	2	45920	\$33.78
7/8	7/16	1/2	1/2	2-1/4	45922	\$42.46
1	1/2	5/8	1/4	1-3/4	45924	\$39.62
1	1/2	11/16	1/2	2-1/8	45926	\$49.25
1-1/4	5/8	3/4	1/2	2-5/16	45928	\$56.35

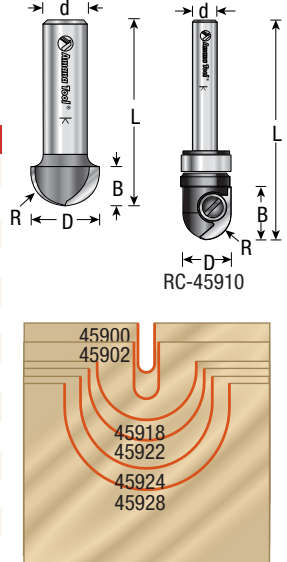

SOLID CARBIDE BOTTOM ROUND

2 Flute

ØD	R	B	Ød	L	Tool No.	Price
1/4	1/8	3/8	1/4	2-1/2	45784	\$60.80



CLASSICAL GROOVE

Carbide Tipped • 2 Flute

ØD	R	R1	B	Ød	L	Tool No.	Price
1/2	3/32	9/64	7/16	1/4	2	56108	\$39.34
3/4	9/64	5/32	1/2	1/4	2-1/16	56110	\$45.61
3/4	9/64	5/32	1/2	1/2	2-3/4	56112	\$50.26
1	13/64	1/4	11/16	1/2	3	56114	\$54.95

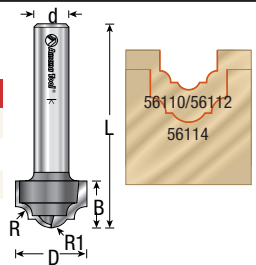

CNC • Carbide Tipped • 2 Flute

ØD	R	B	Ød	L	Max RPM	Tool No.	Price
1-1/4	5/8	1-1/4	1/2	2-3/4	18,000	45944-CNC	\$93.80
1-1/2	3/4	1-1/4	1/2	2-3/4	18,000	45946-CNC	\$106.37
2	1	1-1/4	1/2	2-3/4	18,000	45948-CNC	\$122.82

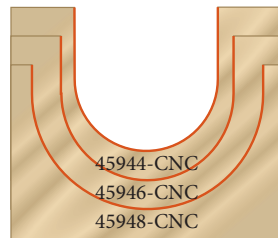
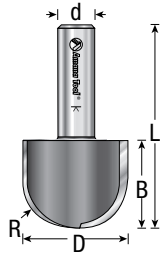

CLASSICAL GROOVE

With Upper Ball Bearing Guide

Carbide Tipped • 2 Flute

ØD	R	R1	B	Ød	L	Tool No.	Price
7/8	5/32	7/32	1/2	1/4	2	56130	\$64.09
1-3/8	1/4	13/32	9/16	1/2	2-5/8	56140	\$76.34

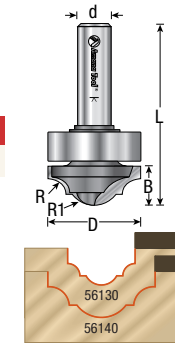

Replacement Parts:

Ball Bearing	Lock Ring	Tool No.	Price
47708	47748	56130	\$64.09
47734	47750	56140	\$76.34

CLASSICAL GROOVE

With Upper Ball Bearing Guide

Carbide Tipped • 2 Flute

ØD	ØD1	R	B	Ød	L	Tool No.	Price
7/8	.319	9/64	3/8	1/4	2	56148	\$64.12
1-3/8	.522	13/64	9/16	1/2	2-5/8	56150	\$76.34

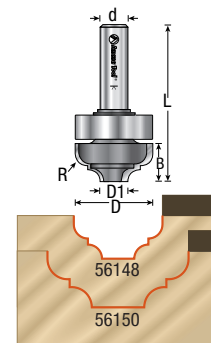

Replacement Parts:

Ball Bearing	Lock Ring	Tool No.
47708	47748	56148
47734	47750	56150

ELONGATED CORE BOX

Carbide Tipped • 2 Flute • Extra Deep

ØD	R	B	Ød	L	Tool No.	Price
3/8	3/16	1	1/2	2-3/4	45930	\$33.60
9/16	9/32	1-1/4	1/2	2-3/4	45934	\$50.12
5/8	5/16	1-1/4	1/2	2-3/4	45936	\$53.87
3/4	3/8	1-1/4	1/2	2-3/4	45938	\$56.18
1	1/2	1-1/4	1/2	2-3/4	45942	\$61.71
1-1/4	5/8	1-1/4	1/2	2-3/4	45944	\$76.27
1-1/2	3/4	1-1/4	1/2	2-3/4	45946	\$85.82
2	1	1-1/4	1/2	2-3/4	45948	\$100.21
2-1/4	1-1/8	1-1/4	1/2	3	45949	\$114.28

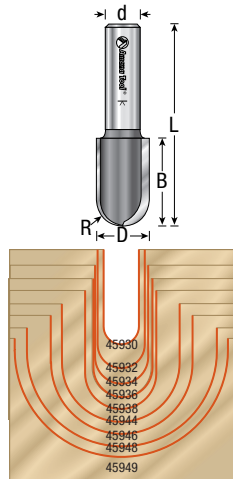

SOLID CARBIDE UP-CUT SPIRAL FLUTE

2 Flute • Ball Nose

ØD	B	Ød	L	Tool No.	Price
3/8	1-1/4	3/8	3	46378	\$49.39
1/2	1-1/4	1/2	3	46380	\$75.60
1/2	2-1/8	1/2	4	46384	\$105.81
5/8	2-1/8	5/8	4	46386	\$112.58

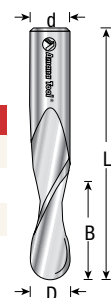

ROUND OVER GROOVE

Carbide Tipped • 2 Flute

ØD	ØD1	R	B	B1	Ød	L	Tool No.	Price
3/4	.240	1/4	1/2	3/8	1/2	2	49700	\$46.13
.615	.240	3/16	1/2	3/16	1/2	2-1/8	49701	\$46.13
7/8	.245	5/16	9/16	7/16	1/2	2-1/16	49702	\$47.32
7/8	1/2	1/8	1-1/4	1-1/8	1/2	2-1/2	49720	\$59.54
1	.250	3/8	5/8	15/32	1/2	2-1/8	49704	\$49.91
1-3/8	.363	1/2	1	3/4	1/2	2-1/2	49706	\$61.32
1-3/4	.500	5/8	1-1/4	1	1/2	2-3/4	49708	\$64.89
2	.500	3/4	1-7/16	1-1/8	1/2	2-15/16	49710	\$71.89

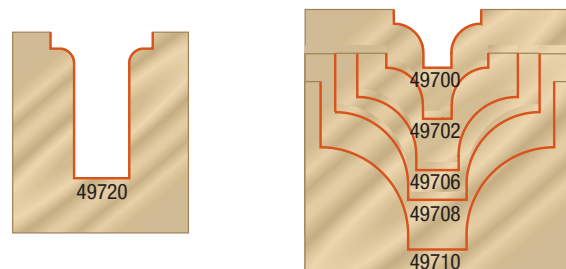
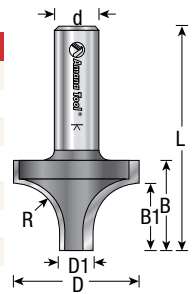

3D renderings & tool illustrations not shown at actual size.

AMANA POINT CUTTING ROUNDOVER Carbide Tipped • 2 Flute

ØD	R	B	B1	Ød	L	Tool No.	Price
1/4	1/8	5/16	1/8	1/4	2	56125	\$19.43

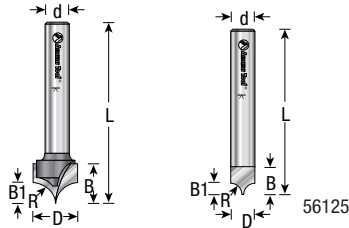
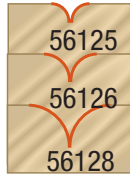

ROUND OVER GROOVE Plunge Ovolo Router Bits Carbide Tipped • 2 Flute

ØD	R	R1	B	Ød	L	Tool No.	Price
1-3/4	23/32	—	23/32	1/2	2-3/16	49570	\$63.35
1-5/8	1	—	23/32	1/2	2-3/16	49572	\$63.35
1-5/8	19/32	1/4	23/32	1/2	2-3/16	49574	\$69.23

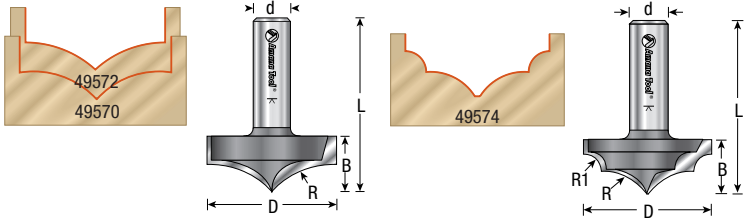

BEADING GROOVE Carbide Tipped • 2 Flute

ØD	ØD1	R	B	Ød	L	Tool No.	Price
25/64	1/8	3/32	23/64	1/4	1-29/32	56100	\$24.78
1-1/4	1/2	3/8	5/8	1/2	2-9/16	56179-CNC	\$52.26

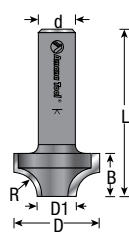
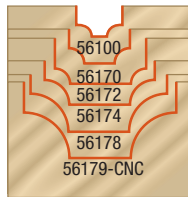

OGEE GROOVE Carbide Tipped • 2 Flute

ØD	ØD1	R	B	Ød	L	Tool No.	Price
3/4	.256	9/64	1/2	1/2	2-3/4	56118	\$45.64
1/2	.157	5/64	3/8	1/4	2	56122	\$32.13

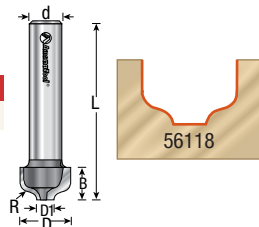

ROUND & OGEE GROOVE Carbide Tipped • 2 Flute

ØD	R	R1	B	Ød	L	Tool No.	Price
1-5/8	3/8	3/4	23/32	1/2	2-3/16	49232	\$53.97

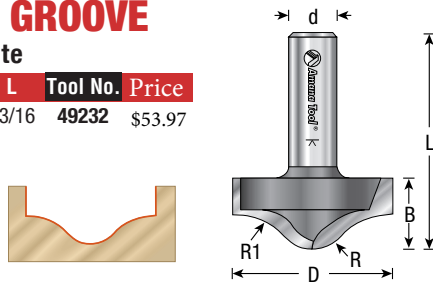

ROUND OVER GROOVE CNC • Carbide Tipped • 2 Flute

ØD	ØD1	R	B	B1	Ød	L	Tool No.	Price
1-3/8	23/64	1/2	1	3/4	1/2	2-1/2	49706-CNC	\$60.87
2	1/2	3/4	1-7/16	1-1/8	1/2	2-15/16	49710-CNC	\$79.28

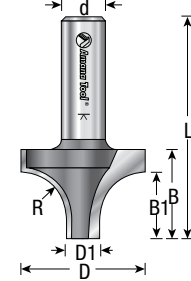
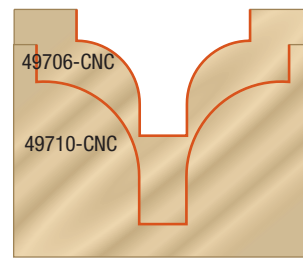

OGEE GROOVE Carbide Tipped • 2 Flute

ØD	ØD1	R	B	Ød	L	Tool No.	Price
15/16	5/16	5/32	21/32	1/4	1-7/8	56204	\$38.40
1	3/8	3/16	19/32	1/2	1-7/8	56208	\$35.35
1-3/16	15/32	15/64	19/32	1/2	1-7/8	56210	\$41.48

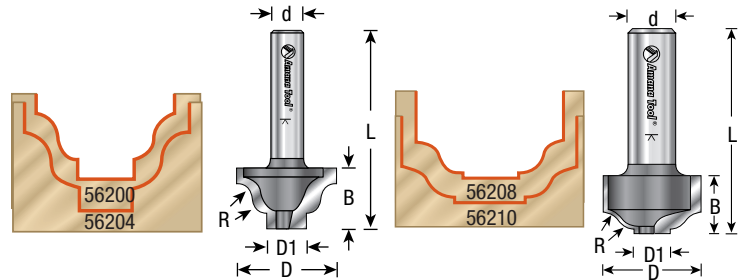

RAISED PANEL GROOVE Carbide Tipped • 2 Flute

ØD	ØD1	a°	B	Ød	L	Tool No.	Price
1-1/8	.454	30°	1/2	1/2	2-3/4	56116	\$52.19

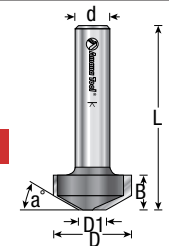

CHAMFER With Ball Bearing Guide

a°	ØD	B	C	Ød	L	Tool No.	Price
45°	1-1/4	1/2	5/8	1/4	2	49400	\$27.27
45°	1-1/4	1/2	5/8	1/2	2-3/8	49402	\$28.11
45°	2	3/4	1-1/8	1/2	2-1/2	49404	\$84.63
45°	2-3/8	1	1-3/8	1/2	2-7/8	49406	\$88.45
45°	3	1-1/8	1-1/2	1/2	3	49405	\$114.84
11-1/4°	7/8	1	1	1/2	2-7/8	49407	\$31.92
15°	7/8	3/4	25/32	1/4	2-1/4	49408	\$27.97
22-1/2°	1-1/4	15/16	7/8	1/2	2-7/8	49410	\$31.64
30°	1-3/8	13/16	7/8	1/4	2-1/4	49412	\$29.82
30°	1-3/8	13/16	7/8	1/2	2-3/4	49414	\$29.82
60°	2-1/2	11/16	1-1/8	1/2	2-3/4	49416	\$99.82

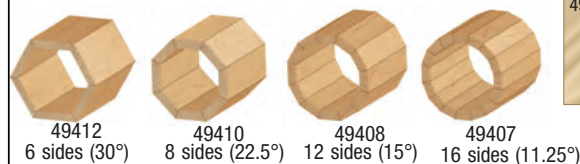
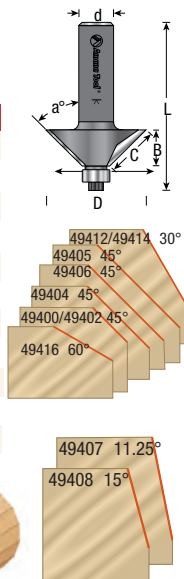

3D renderings & tool illustrations not shown at actual size.

AMANA VARIABLE DOUBLE CHAMFER ASSEMBLY

With Ball Bearing Guide

Carbide Tipped • 3-Wing

ØD	a°1	a°2	B1	Ød	L	Tool No.	Price
1-3/8	30°	45°	9/16	1/2	4-1/4	49730	\$131.39

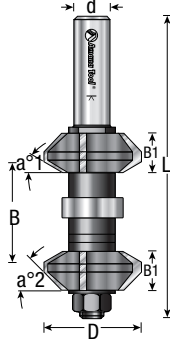
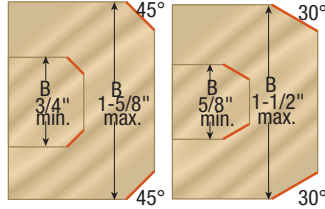

CORNER ROUNDING

With Ball Bearing Guide

Carbide Tipped • 2 Flute

ØD	R	B	Ød	L	Tool No.	Price
5/8	1/16	5/16	1/4	1-3/4	49492	\$29.89
5/8	1/16	5/16	1/2	2-1/4	49494	\$31.12
3/4	1/8	3/8	1/4	2	49496	\$28.70
3/4	1/8	3/8	1/2	2-5/16	49498	\$31.12
13/16	5/32	3/8	1/4	2	49499	\$31.26
13/16	5/32	3/8	1/2	2-1/4	49501	\$31.96
7/8	3/16	1/2	1/4	2	49500	\$29.23
7/8	3/16	1/2	1/2	2-7/16	49502	\$30.00
1	1/4	1/2	1/4	2	49504	\$29.12
1	1/4	1/2	1/2	2-7/16	49506	\$29.54
1-1/8	5/16	1/2	1/4	2-1/16	49508	\$31.12
1-1/8	5/16	1/2	1/2	2-7/16	49510	\$32.06
1-1/4	3/8	5/8	1/4	2-3/16	49512	\$30.49
1-1/4	3/8	5/8	1/2	2-9/16	49514	\$31.50
1-3/8	7/16	5/8	1/2	2-9/16	49515	\$50.47
1-1/2	1/2	3/4	1/4	2-1/4	49516	\$33.57
1-1/2	1/2	3/4	1/2	2-5/8	49518	\$34.55
1-5/8	9/16	3/4	1/2	2-5/8	49517	\$51.07
1-3/4	5/8	7/8	1/2	2-3/4	49519	\$51.52
2	3/4	1	1/2	2-7/8	49520	\$54.78
2-1/4	7/8	1-1/4	1/2	3-1/16	49521	\$96.85
2-1/2	1	1-1/4	1/2	3-3/16	49522	\$106.30
2-3/4	1-1/8	1-3/8	1/2	3-1/4	49523	\$138.99
3	1-1/4	1-1/2	1/2	3-1/4	49524	\$146.37
3-1/2	1-1/2	1-3/4	1/2	3-5/8	49526	\$165.34

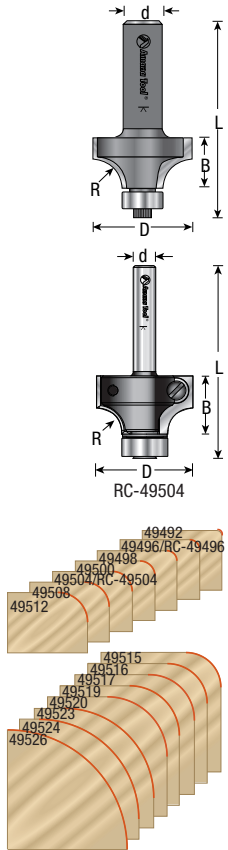

BEADING

With Ball Bearing Guide

ØD	R	B	Ød	L	Tool No.	Price
7/8	3/16	1/2	1/4	2	49600	\$29.23
1	1/4	1/2	1/4	2	49604	\$29.12
1	1/4	1/2	1/2	2-7/16	49606	\$29.54
1-1/8	5/16	1/2	1/2	2-7/16	49610	\$32.06
1-1/4	3/8	5/8	1/4	2-3/16	49612	\$30.49
1-1/4	3/8	5/8	1/2	2-9/16	49614	\$31.50
1-1/2	1/2	3/4	1/2	2-5/8	49618	\$34.55
1-3/4	5/8	7/8	1/2	2-3/4	49619	\$51.52
2	3/4	1	1/2	2-7/8	49620	\$54.78
2-1/2	1	1-1/4	1/2	3-3/16	49622	\$106.30

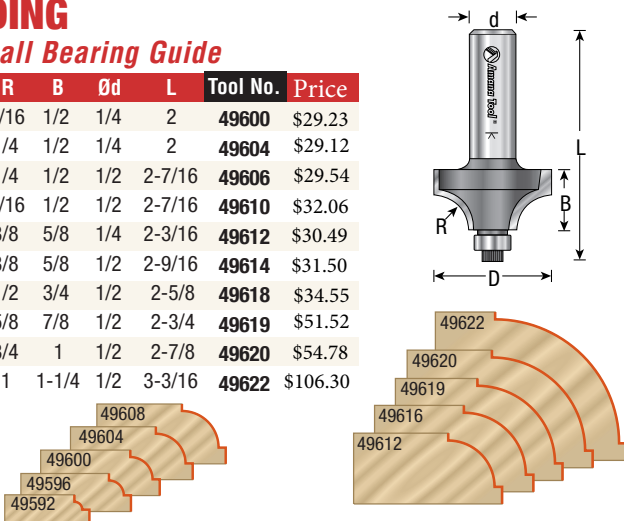

3D renderings & tool illustrations not shown at actual size.

CORNER ROUNDING 3D

Carbide Tipped • 2 Flute

ØD	R	B	Ød	L	Repl. Alum. Ring	Tool No.	Price
1	1/8	5/16	1/2	3-13/16	47790	49528	\$87.15
1-7/16	1/4	13/32	1/2	3-29/32	47792	49529	\$89.11

Replacement bearings #47706 and #47721.
Replacement allen screw #67011.
Replacement locking #67176.
Replacement allen key #67165.



BULLNOSE

Carbide Tipped

2 Flute & 3 Flute (51566 Only)

*M'	R	B	ØD	Ød	L	Tool No.	Price
5/32	5/64	1/2	17/32	1/4	1-3/4	51540	\$40.04
7/32	7/64	1/2	19/32	1/4	1-3/4	51542	\$41.16
19/64	9/64	3/4	21/32	1/4	1-7/8	51544	\$45.12
5/32	5/64	1/2	17/32	1/2	2	51550	\$43.05
7/32	7/64	1/2	19/32	1/2	2	51552	\$44.10
9/32	9/64	3/4	21/32	1/2	2-1/4	51554	\$45.19
27/64	13/64	3/4	7/8	1/2	2-1/4	51556	\$53.76
35/64	17/64	1	1-1/32	1/2	2-1/2	51558	\$58.14
5/8	5/16	1	1-1/8	1/2	2-1/2	51559	\$75.32
3/4	3/8	1-5/16	1-1/4	1/2	2-3/4	51560	\$75.32
1	1/2	1-9/16	1-11/16	1/2	3-1/16	51562	\$87.85
1-1/4	5/8	2	2	1/2	3-1/2	51564	\$100.87
1-1/2	3/4	2	2-3/8	1/2	3-1/2	51566	\$163.49

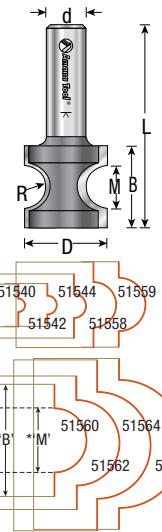

BULLNOSE

With Ball Bearing Guide

Carbide Tipped • 2 Flute

*M'	R	B	ØD	Ød	L	Tool No.	Price
3/16	7/64	1/2	19/32	1/4	2-1/8	51567	\$42.77
1/4	9/64	3/4	21/32	1/4	2-3/8	51568	\$54.18
3/8	13/64	3/4	7/8	1/2	2-3/4	51569	\$72.52
35/64	17/64	1	1-1/16	1/2	2-7/8	51570	\$67.20
3/4	3/8	1-5/16	1-3/8	1/2	3-1/4	51572	\$86.28
1	1/2	1-19/32	1-13/16	1/2	3-1/2	51574	\$92.37
1-1/4	5/8	2	2	1/2	3-7/8	51576	\$106.40

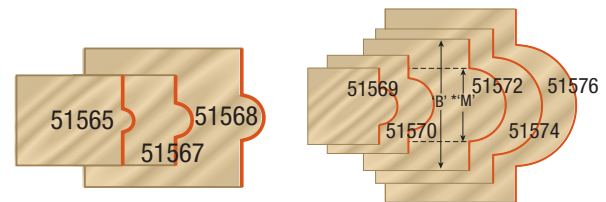
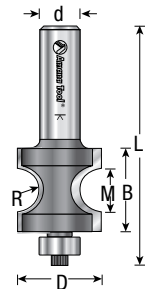

CORNER BEADING

With Ball Bearing Guide

Carbide Tipped • 2 Flute

ØD	ØD1	R	B	B1	Ød	L	Tool No.	Price
7/8	3/4	1/8	9/16	1/4	1/4	2-1/8	54160	\$32.06
7/8	3/4	1/8	9/16	1/4	1/2	2-1/2	54162	\$32.76
1-1/8	1	3/16	11/16	3/8	1/4	2-1/4	54164	\$36.19
1-1/8	1	3/16	11/16	3/8	1/2	2-5/8	54166	\$37.21
1-1/4	1-1/8	1/4	23/32	17/32	1/4	2-5/16	54168	\$41.58
1-1/4	1-1/8	1/4	23/32	17/32	1/2	2-11/16	54170	\$42.21

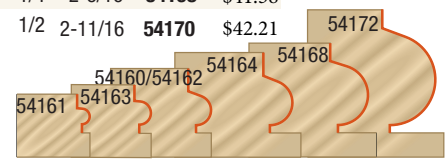
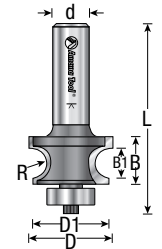

AMANA
COVE & BEAD
With Ball Bearing Guide

Carbide Tipped • 2 Flute

ØD	R	B	Ød	L	Tool No.	Price
1	5/32	5/8	1/4	2-1/8	49208	\$42.21
1	5/32	5/8	1/2	2-1/2	49210	\$44.45
1-3/8	1/4	7/8	1/4	2-1/4	49212	\$47.71
1-3/8	1/4	7/8	1/2	2-5/8	49214	\$48.41

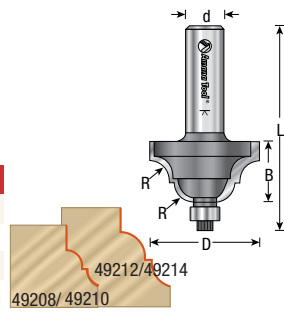

CLASSICAL BEAD & COVE
With Ball Bearing Guide

Carbide Tipped • 2 Flute

ØD	R	R1	B	Ød	L	Tool No.	Price
1-1/4	13/64	5/16	1/2	1/4	2	54102	\$43.65
1-1/4	13/64	5/16	1/2	1/2	2-3/8	54104	\$44.24
1-1/2	7/32	15/64	5/8	1/4	2-1/8	54106	\$56.28
1-1/2	7/32	15/64	5/8	1/2	2-1/2	54108	\$54.29

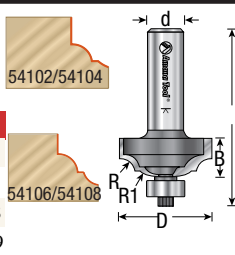

CLASSICAL COVE & BEAD
With Ball Bearing Guide

Carbide Tipped • 2 Flute

ØD	R	R1	B	Ød	L	Tool No.	Price
1-1/8	5/32	5/32	1/2	1/4	2	54128	\$51.84
1-3/8	1/4	3/16	11/16	1/4	2-3/16	54130	\$55.30
1-1/8	5/32	5/32	1/2	1/2	2-3/8	54132	\$50.89
1-3/8	1/4	3/16	11/16	1/2	2-9/16	54134	\$55.30
1-1/2	3/16	5/16	5/8	1/2	2-1/2	54292	\$48.69
2	11/32	11/32	1-1/4	1/2	3-1/8	54100	\$75.15
2	3/8	3/8	1	1/2	2-3/4	54135	\$76.72

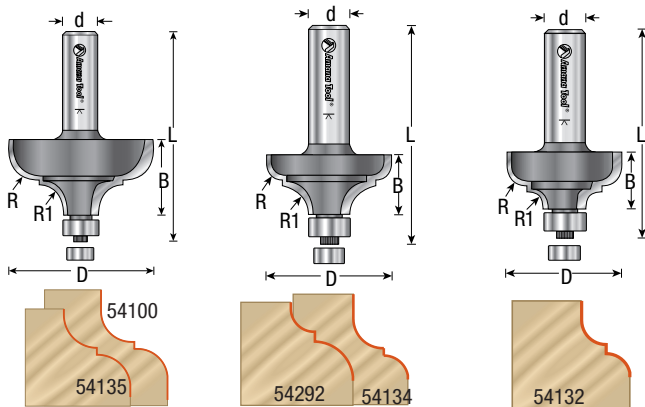

OGEE FILLET
With Ball Bearing Guide

Carbide Tipped • 2 Flute

ØD	R	B	Ød	L	Tool No.	Price
1-3/8	5/32	1/2	1/4	2-1/16	54110	\$52.22
1-3/8	5/32	1/2	1/2	2-1/2	54112	\$52.01
1-5/8	1/4	3/4	1/2	2-5/8	54114	\$66.29
2-1/4	3/8	15/16	1/2	2-7/8	54127	\$108.82

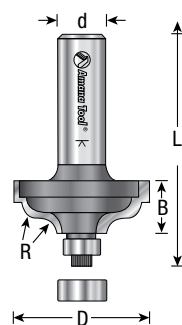
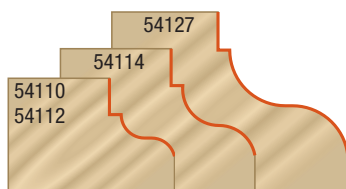

COVE
With Ball Bearing Guide
Carbide Tipped • 2 Flute

ØD	R	B	Ød	L	Tool No.	Price
1/2	1/16	1/2	1/4	2	49092	\$33.53
5/8	1/8	1/2	1/4	2	49094	\$33.53
3/4	3/16	9/16	1/2	2-3/8	49102	\$33.92
7/8	1/4	9/16	1/4	2	49104	\$32.17
7/8	1/4	9/16	1/2	2-3/8	49106	\$33.36
1	5/16	9/16	1/4	2-1/8	49108	\$33.39
1	5/16	9/16	1/2	2-3/8	49110	\$34.48
1-1/8	3/8	9/16	1/4	2	49112	\$32.41
1-1/8	3/8	9/16	1/2	2-3/8	49114	\$33.57
1-3/8	1/2	3/4	1/4	2-1/4	49116	\$36.30
1-3/8	1/2	3/4	1/2	2-1/2	49118	\$37.00
1-5/8	5/8	11/16	1/2	2-1/2	49119	\$63.00
2	3/4	1	1/2	2-7/8	49120	\$69.55
2-1/4	7/8	1-1/4	1/2	3-1/8	49121	\$125.79
2-1/2	1	1-1/4	1/2	3	49122	\$139.06

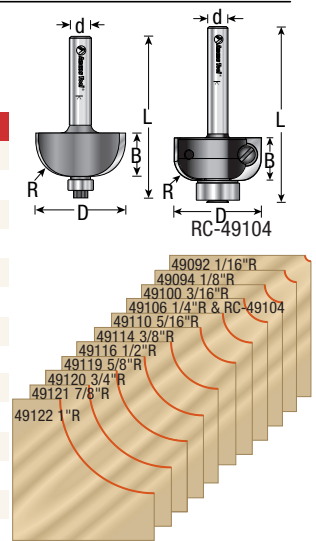

LARGE RADIUS OVOLO
Carbide Tipped • 2 Flute

ØD	R	B	Ød	L	Tool No.	Price
1-5/8	2	1-3/4	1/2	3-1/4	49124	\$113.05
2-1/16	2-3/4	2-3/16	1/2	3-13/16	49126	\$143.50

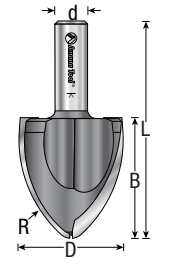

CLASSICAL COVE
With Ball Bearing Guide
Carbide Tipped • 2 Flute

ØD	R	B	Ød	L	Tool No.	Price
1-1/8	3/16	1/2	1/4	2	54144	\$45.40
1-3/8	5/16	5/8	1/2	2-1/2	54150	\$51.45

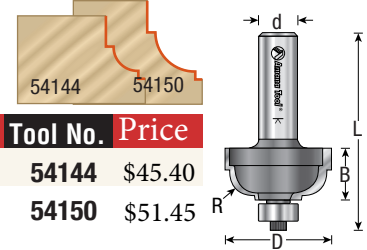

ROMAN OGEE
With Ball Bearing Guide
Carbide Tipped • 2 Flute

ØD	R	B	Ød	L	Tool No.	Price
1	5/32	5/8	1/4	2-1/8	49200	\$34.83
1	5/32	5/8	1/2	2-1/2	49202	\$37.28
1-3/8	1/4	13/16	1/4	2-1/4	49204	\$37.42
1-3/8	1/4	13/16	1/2	2-5/8	49206	\$39.31

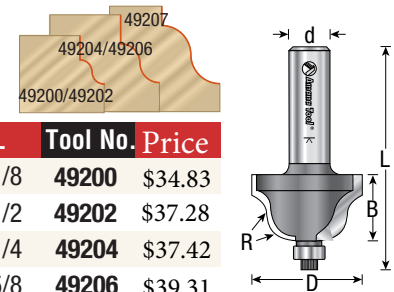

HAND GRIP PLUNGE
Carbide Tipped • 2 Flute

ØD	a°	R	B	B1	B2	Ød	L	Tool No.	Price
1-1/8	45°	1/2	1-9/16	7/8	1-1/4	1/2	3-5/8	51590	\$61.04

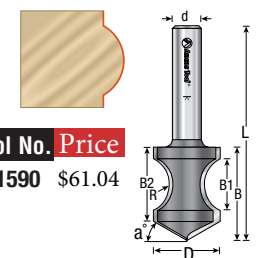

3D renderings & tool illustrations not shown at actual size.

AMANA
BULLNOSE/COVE EDGE
With Ball Bearing Guide

Carbide Tipped • 2 Flute

ØD	R	R1	B	Ød	L	Tool No.	Price
1-1/8	1/8	1/4	1	1/2	2-7/8	51530	\$111.20

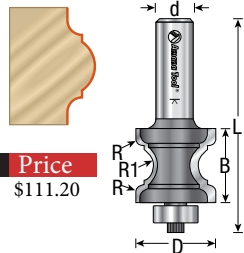

FLUTE & BEAD SET

Carbide Tipped • 2 Flute

ØD	R	B	B1	Ød	L	L1	Tool No.	Price
1-1/2	1/8	1/2	1/4	1/2	2	1-3/4	54176	\$56.18



CONVEX EDGING

With or Without Ball Bearing Guide

Carbide Tipped • 2 Flute

ØD	R	B	B1	Ød	L	Tool No.	Price
13/16	23/32	1-1/4	27/32	1/4	2-1/2	51580	\$44.07
13/16	23/32	1-1/4	27/32	1/2	2-3/4	51582	\$44.07

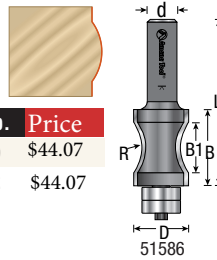

VARIABLE BEADING

Carbide Tipped • 2 Flute

ØD	R	R1	R2	B	Ød	L	Tool No.	Price
7/8	9/64	7/64	1/16	1-1/16	1/2	2-5/8	54216	\$45.64

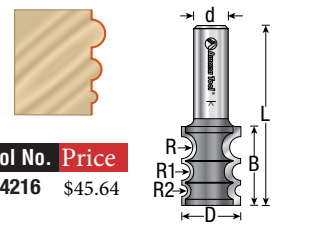

CLASSICAL MOLDING

With Ball Bearing Guide

Carbide Tipped • 2 Flute

ØD	R	B	Ød	L	Tool No.	Price
1-1/8	5/32	1/2	1/4	2	54136	\$45.43
1-3/8	7/32	11/16	1/4	2-3/16	54138	\$52.22
1-1/8	5/32	1/2	1/2	2-3/8	54140	\$48.48
1-3/8	7/32	11/16	1/2	2-9/16	54142	\$59.26
1-1/2	1/4	3/4	1/2	2-3/4	54141	\$61.67

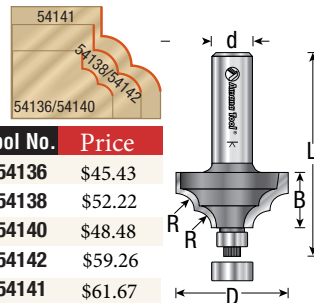

MATCHED BEAD

With Ball Bearing Guide

Carbide Tipped • 2 Flute

ØD	R	B	Ød	L	Tool No.	Price
1-1/4	3/16	1	1/2	2-7/8	54186	\$94.92
2	1/4	1-1/4	1/2	3	54188	\$105.63

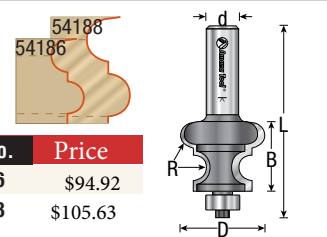

WAVY EDGE

With Ball Bearing Guide

Carbide Tipped • 2 Flute

ØD	R	B	Ød	L	Tool No.	Price
1-1/4	5/32	11/16	1/4	2-1/4	54180	\$43.61
1-1/4	5/32	11/16	1/2	2-5/8	54182	\$43.61

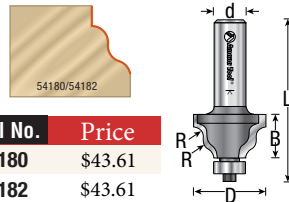

EDGE MOLDING

With Ball Bearing Guide

Carbide Tipped • 2 Flute

ØD	R	R1	B	Ød	L	Tool No.	Price
1-1/4	5/32	5/32	7/8	1/2	2-3/4	54322	\$88.20
1-9/16	7/32	15/64	1-3/16	1/2	3	54324	\$113.40

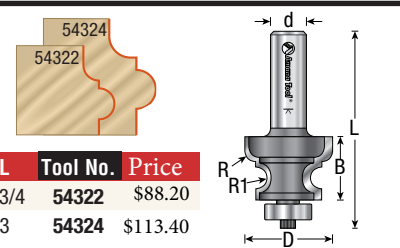

REED EDGE

Carbide Tipped • 2 Flute

ØD	R	R1	B	Ød	L	Tool No.	Price
3/4	5/64	15/64	1	1/4	2-1/8	54360	\$59.05

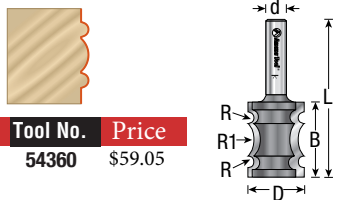

MULTI-EDGE BEADING

With Double Ball Bearings

Carbide Tipped • 2 Flute

ØD	R	B	Ød	L	Tool No.	Price
1	3/16	7/8	1/4	2-7/8	54296	\$78.05

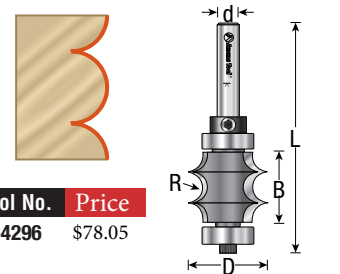

OGEE

With Ball Bearing Guide

Carbide Tipped • 2 Flute

ØD	R	R1	B	Ød	L	Tool No.	Price
1-1/8	5/32	5/32	1/2	1/4	2	54120	\$46.38
1-3/8	1/4	3/16	11/16	1/4	2-3/16	54122	\$55.86
1-1/8	5/32	5/32	1/2	1/2	2-3/8	54124	\$51.07
1-3/8	1/4	3/16	11/16	1/2	2-9/16	54126	\$58.98

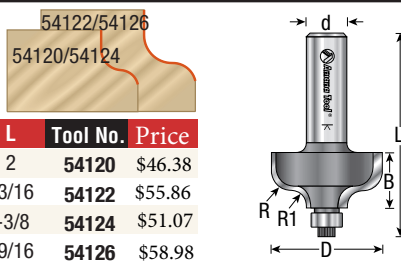

EDGE BEADING

Carbide Tipped • 2 Flute

ØD	ØD1	R	B	Ød	L	Tool No.	Price
7/8	1/2	5/32	1-1/32	1/2	2-3/4	54208	\$44.77

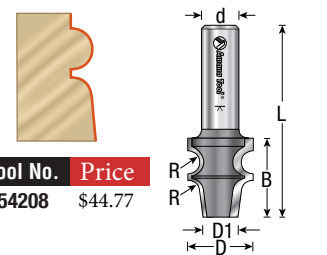

'LEAF-EDGE' BEADING

With Ball Bearing Guide

Carbide Tipped • 2 Flute

ØD	R	B	Ød	L	Tool No.	Price
1	3/16	1/2	1/4	2-1/2	54190	\$49.21
1-1/8	1/4	5/8	1/4	2-5/8	54192	\$51.31

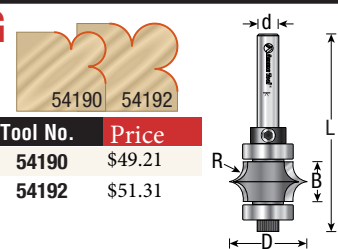

EDGE FLUTING

With Ball Bearing Guide

Carbide Tipped • 2 Flute

ØD	R	B	C	Ød	L	Tool No.	Price
3/4	5/16	1/2	1/8	1/2	2-3/4	54302	\$26.22
7/8	15/32	3/4	3/16	1/2	3	54304	\$35.95
7/8	3/4	1	3/16	1/2	3-1/4	54306	\$46.13
1	1-1/4	1-1/2	1/4	1/2	3-3/4	54308	\$59.33

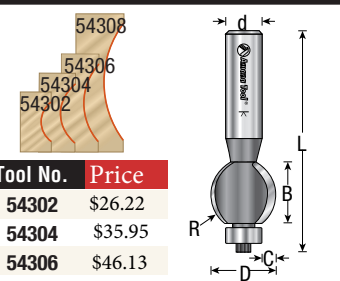

3D renderings & tool illustrations not shown at actual size.

AMANA EDGE-FLUTING ASSEMBLY

With Upper & Lower Ball Bearing Guides
Carbide Tipped • 2 Flute

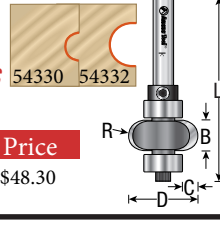

ØD	R	B	C	Ød	L	Tool No.	Price
7/8	13/64	3/8	1/4	1/4	2-3/8	54332	\$48.30

DOUBLE BEADING *With Ball Bearing Guide*

Carbide Tipped • 2 Flute

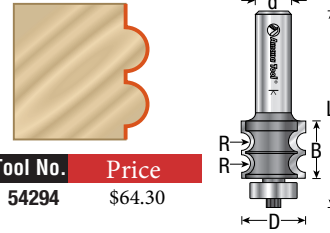

ØD	R	B	Ød	L	Tool No.	Price
7/8	1/8	3/4	1/2	2-5/8	54294	\$64.30

TRIPLE BEADING/ TRIPLE FLUTING *With Ball Bearing Guide*

Carbide Tipped • 2 Flute

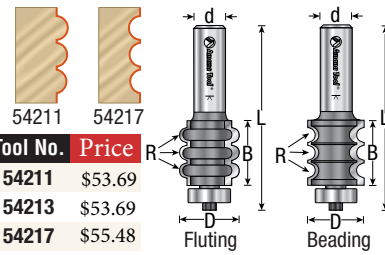

ØD	Type	R	B	Ød	L	Tool No.	Price
7/8	Bead	1/8	1	1/4	2-5/8	54211	\$53.69
7/8	Bead	1/8	1	1/2	3	54213	\$53.69
7/8	Flute	1/8	1	1/2	3	54217	\$55.48

TRIPLE BEADING Carbide Tipped • 2 Flute

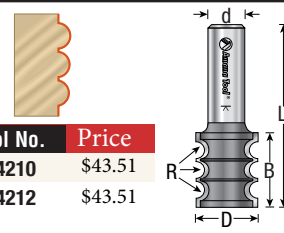

ØD	Type	R	B	Ød	L	Tool No.	Price
7/8	Bead	1/8	1	1/4	2-1/4	54210	\$43.51
7/8	Bead	1/8	1	1/2	2-3/4	54212	\$43.51

RABBET *With Ball Bearing Guide*

Carbide Tipped • 2 Flute

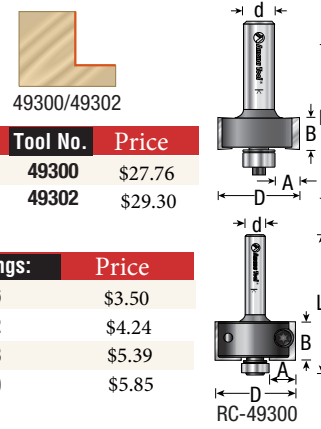

ØD	A	B	Ød	L	Tool No.	Price
1-1/4	3/8	1/2	1/4	2	49300	\$27.76
1-1/4	3/8	1/2	1/2	2-3/8	49302	\$29.30

A	Replacement Bearings:	Price
Standard	3/8 Rabbet — 47706	\$3.50
OR	7/16 Rabbet — 47702	\$4.24
OR	5/16 Rabbet — 47718	\$5.39
OR	1/4 Rabbet — 47720	\$5.85

MULTI-RABBET SET *With Ball Bearing Guide*

Carbide Tipped • 2 Flute

Six Different Rabbet Depths

A	Replacement Bearings:	Price
1/2 Rabbet	47702	\$4.24
7/16 Rabbet	47706	\$3.50
1/8 Rabbet	47743	\$6.76

ØD	A	B	Ød	L	Tool No.	Price
1-3/8	1/8, 1/4, 5/16, 3/8, 7/16, 1/2	1/2	1/4	2	49340	\$37.70
1-3/8	1/8, 1/4, 5/16, 3/8, 7/16, 1/2	1/2	1/2	2-3/8	49350	\$37.70

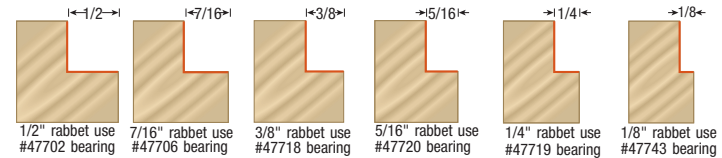

3D renderings & tool illustrations not shown at actual size.

CNC INSERT CARBIDE STRAIGHT RABBETING

With Scorer 2+2 Design

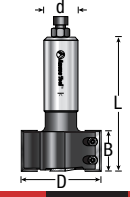

ØD	B	Ød	L	Repl. T.C. Knife	Repl. T.C. Knife	Max RPM	Tool No.	Price
40mm(1-1/2)	30mm(1-3/16)	3/4	100mm(4)	RCK-30	RCK-70	18,000	RC-2380	\$285.81
40mm(1-1/2)	50mm(2)	3/4	120mm(4-3/4)	RCK-50	RCK-70	18,000	RC-2381	\$309.37
60mm(2-3/8)	30mm(1-3/16)	3/4	100mm(4)	RCK-30	RCK-70	18,000	RC-2382	\$309.37
60mm(2-3/8)	50mm(2)	3/4	120mm(4-3/4)	RCK-50	RCK-70	18,000	RC-2383	\$328.89

INSERT SUPERRABBET, JR™ *With Ball Bearing Guide*

Insert Carbide • 2 Flute

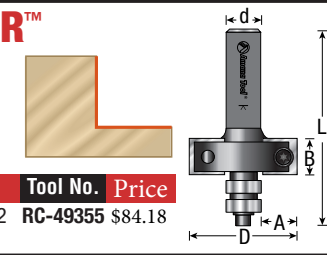

ØD	A	B	Ød	L	Tool No.	Price
1-1/2	Flush to 1/2"	12mm(.472)	1/2	2-19/32	RC-49355	\$84.18

ACCESSORIES FOR INSERT SUPERRABBET™ & INSERT SUPERRABBET, JR™

Collar Diameter	'A' Rabbet Depth	Order No.	Price
1-7/8	1/16	67400	\$7.67
1-3/4	1/8	67402	\$7.67
1-5/8	3/16	67404	\$7.67
1-17/32	15/64(6mm)	67406	\$7.67
1-1/2	1/4	67408	\$7.53
1-3/8	5/16	67410	\$7.53
1-9/32	23/64(9mm)	67412	\$7.53
1-1/4	3/8	67414	\$7.35
1-1/8	7/16	67416	\$7.35
1-1/16	15/32(12mm)	67418	\$7.35
1	1/2	67420	\$7.35
7/8	9/16	67422	\$7.35
13/16	19/32(15mm)	67424	\$7.35
3/4	5/8	67426	\$7.35
5/8	11/16	67428	\$7.35
9/16	23/32(18mm)	67430	\$7.35

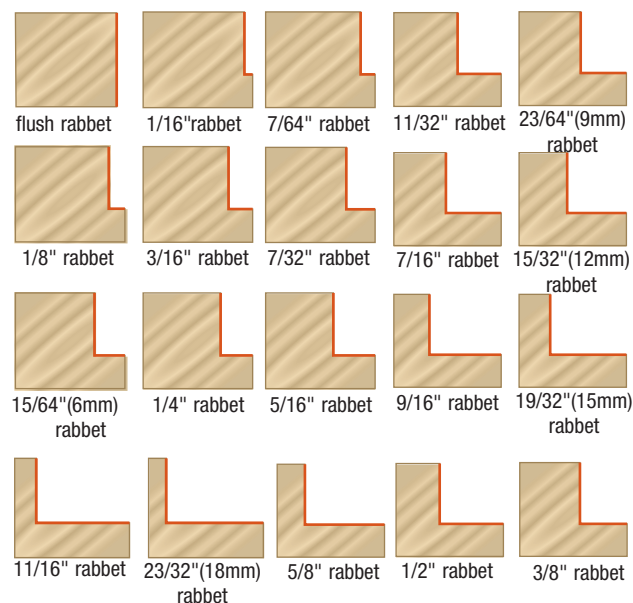

AMANA SUPERABBET™
With Ball Bearing Guide
Carbide Tipped • 2 Flute

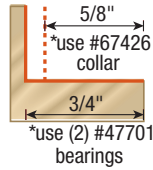

ØD	A	B	Ød	L	Tool No.	Price
2	5/8 & 3/4	7/8	1/2	3	49360	\$73.64

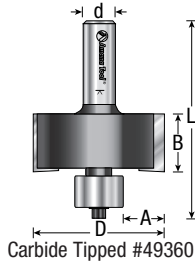

Carbide Tipped #49360

Insert Carbide • 2 Flute

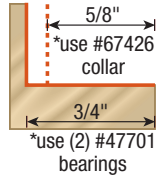

ØD	A	B	Ød	L	Repl. Knives	Tool No.	Price
2	5/8 & 3/4	30mm	1/2	3-3/8	RCK-30	RC-49360	\$128.10

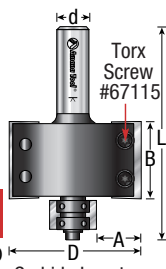

Carbide Inserts #RC-49360
Torx Key #5005.

ARCHITECTURAL ROUTER BITS
BASE MOLDING
OGEE EDGE DETAIL

Carbide Tipped • 2 Flute

ØD	R	R1	B	B1	Ød	L	Tool No.	Price
1-7/16	5/16	3/8	19/32	3/8	1/2	2	54297	\$72.49
1-53/64	19/64	13/32	3/8	—	1/2	2	54299	\$73.26

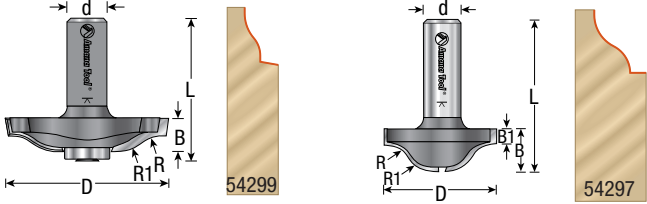

COLONIAL DOOR CASING
(Door & Window Opening Moldings)

Carbide Tipped • 2 Flute

ØD	ØD1	R	R1	B	Ød	L	Tool No.	Price
1-17/32	51/64	3/8	1/4	2-3/4	1/2	4-1/2	54295	\$97.51

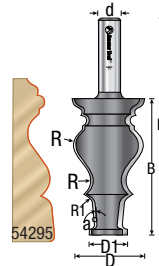

DRAWING LINE
With Ball Bearing Guide
Carbide Tipped • 2 Flute

ØD	R	R1	B	Ød	L	Tool No.	Price
1	1	3/32	7/8	1/2	2-3/4	54350	\$30.38
1	19/32	5/32	7/8	1/2	2-3/4	54354	\$30.38
1	13/32	3/16	7/8	1/2	2-3/4	54356	\$31.36

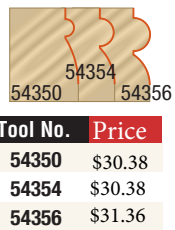

REVERSIBLE CROWN MOLDING EXTENDER
Carbide Tipped • 2 Flute

ØD	R	R1	B	Ød	L	Tool No.	Price
1-1/4	7/16	3-15/16	2-3/8	1/2	4	54410	\$73.15

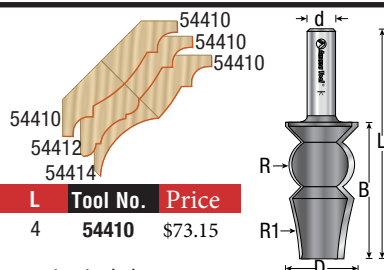

WAINSCOT SETS

Bead, Bevel, Classic & Ogee Styles
Carbide Tipped • 2 Flute • 3/4" Material

ØD	R	R1	a°	B	B1	Ød	L	Type	Tool No.	Price
1-21/32	1/8	1/4	—	1	—	1/2	2-7/8	Chair Rail	54266	\$98.42
3 Piece Set Including 49640, 49642 & 54266									49684	\$145.95
3 Piece Set Including 49664, 49666 & 54266									49680	\$166.32
3 Piece Set Including 49674, 49676 & 54266									49682	\$155.16

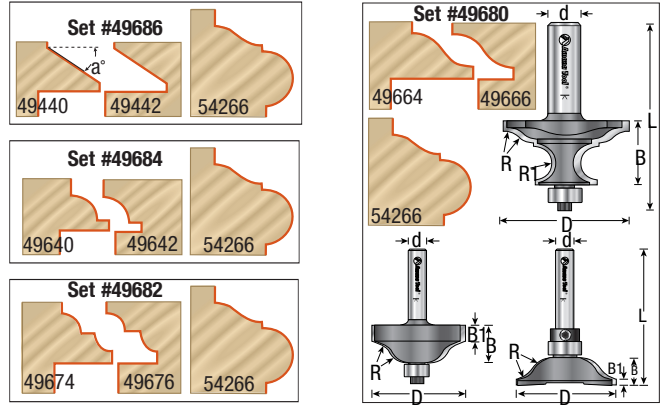

CROWN MOLDING

Carbide Tipped • 2 Flute

ØD	R	R1	B	Ød	L	Tool No.	Price
1-1/4	3/16	7/16	2-1/4	1/2	3-3/4	54400	\$89.50
1-1/4	1/2	3/4	2-1/4	1/2	3-3/4	54402	\$89.50
1-1/4	17/32	17/32	2-1/4	1/2	3-3/4	54404	\$89.50

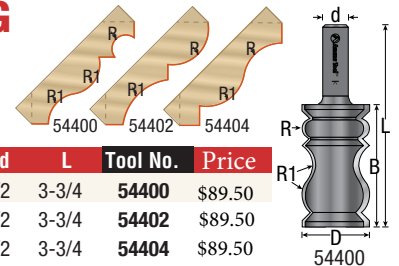

REVERSIBLE CROWN MOLDING

Carbide Tipped • 2 Flute

ØD	R	R1	R2	B	Ød	L	Tool No.	Price
1-1/4	3/8	7/8	7/16	2-7/16	1/2	4-1/16	54412	\$73.15

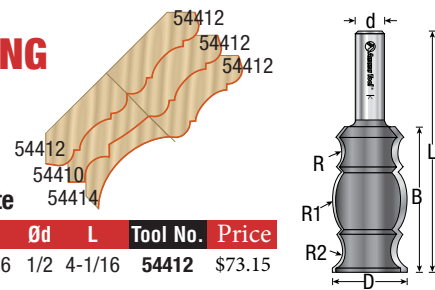

HORIZONTAL CROWN MOLDING

Carbide Tipped • 2 Flute

ØD	R	B	Ød	L	Tool No.	Price
2-1/4	1-3/4	5/8	1/2	2-3/8	54414	\$52.89

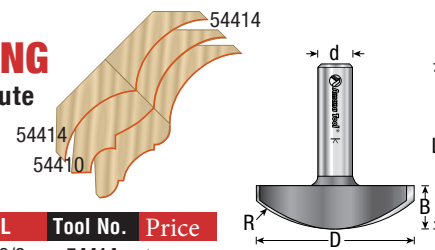

ARCHITECTURAL MOLDING

With Ball Bearing Guide

Carbide Tipped • 2 Flute

Type	ØD	R	R1	B	Ød	L	Tool No.	Price
#12	1-3/16	1/2	1/4	1-3/8	1/2	3-1/4	54234	\$88.38

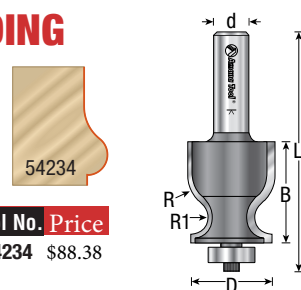

3D renderings & tool illustrations not shown at actual size.

AMANA ARCHITECTURAL MOLDING

With Ball Bearing Guide

Carbide Tipped • 2 Flute

Type	ØD	R	R1	R2	R3	B	Ød	L	Tool No.	Price
#2	7/8	5/32	5/16	—	—	1-3/8	1/2	3-3/8	54204	\$48.20
#3	1	9/64	3/16	25/32	15/64	1-5/8	1/2	3-1/4	54218	\$46.80
#4	1	1/8	7/8	3/8	—	1-11/16	1/2	3-1/4	54220	\$46.80
#5	1-1/2	5/32	—	—	—	2	1/2	3-1/2	54250	\$89.91
#7	1	9/64	3/32	3/4	9/32	1-3/4	1/2	3-5/8	54219	\$49.14

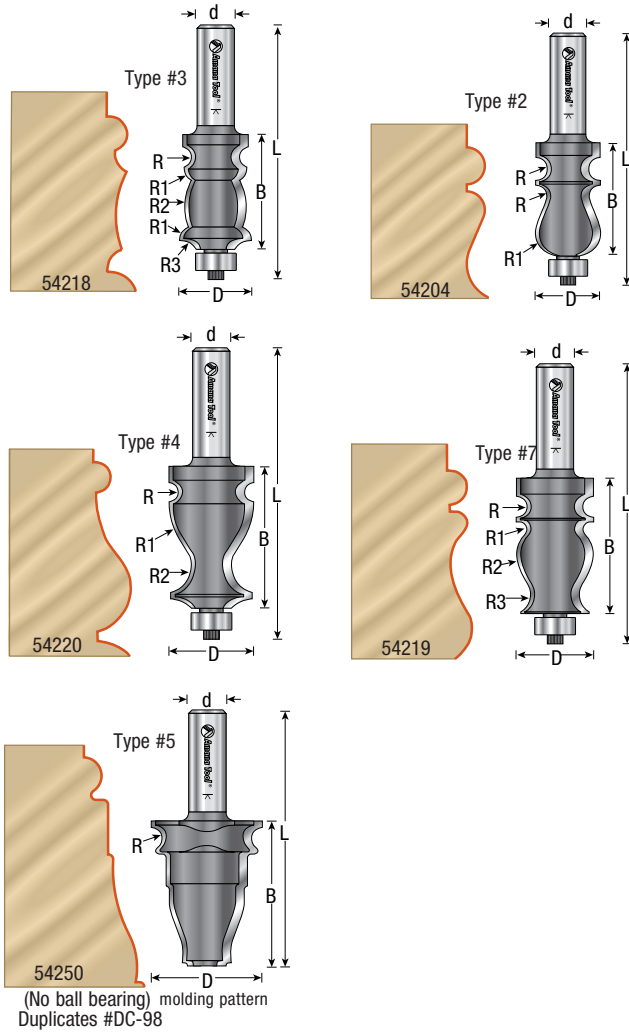

ARCHITECTURAL MOLDING

With Ball Bearing Guide

Carbide Tipped • 2 Flute

Type	ØD	ØD1	R	R1	R2	R3	B	Ød	L	Tool No.	Price
#8	1-3/8	—	1/8	3/32	1/4	7/16	1-5/8	1/2	3-1/2	54222	\$75.64
#9	1-3/8	7/8	1/8	1/16	1/4	7/16	1-5/8	1/2	3-1/2	54224	\$87.99

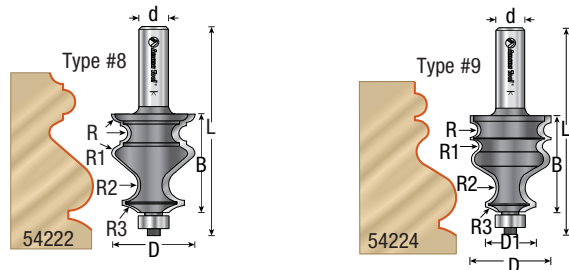

3D renderings & tool illustrations not shown at actual size.

SPECIAL INTEREST MOLDING

With Ball Bearing Guide
Carbide Tipped • 2 Flute

ØD	R	R1	R2	B	Ød	L	Repl. Bearing	Tool No.	Price
1-9/16	5/32	1/2	—	1-1/8	1/2	3	47712	54232	\$98.42
1-5/8	1/8	3/8	1/4	1-1/8	1/2	3	47706	54260	\$78.05
2	5/16	1/4	—	1	1/2	2-7/8	47706	54266	\$98.42

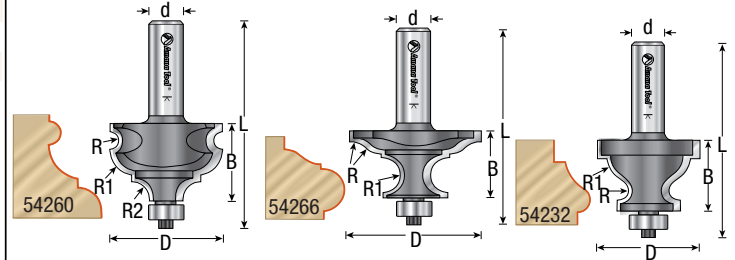

SPECIAL INTEREST MOLDING

With Ball Bearing Guide
Carbide Tipped • 2 Flute

ØD	R	R1	B	Ød	L	Repl. Bearing	Tool No.	Price
1-3/4	23/64	—	1	1/2	3	47712	54286	\$58.66
1-3/4	3/8	3/32	1	1/2	3	47706	54288	\$62.76

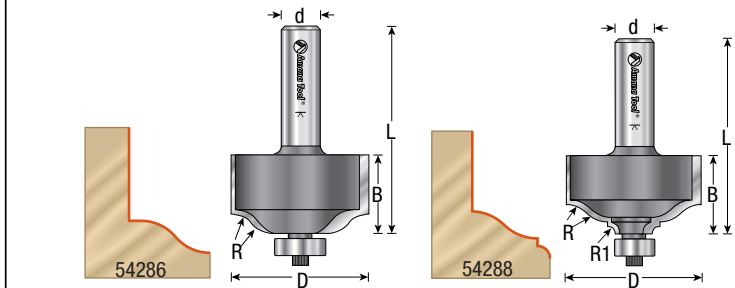

HAND/TABLE EDGE

With Ball Bearing Guide
Carbide Tipped • 2 Flute

ØD	R	R1	B	Ød	L	Tool No.	Price
1-3/16	15/32	—	3/8	1/4	1-3/4	49540	\$36.79
1-3/16	15/32	—	3/8	1/2	2-1/4	49542	\$38.85
2-3/4	1-3/4	—	5/8	1/2	2-7/8	49550	\$113.05
2-1/2	3/8	—	3/4	1/2	2-3/4	49554	\$115.36
2-1/2	3/8	1/4	3/4	1/2	2-3/4	49556	\$115.36
2-5/16	19/64	1/4	7/8	1/2	2-3/4	49558	\$109.27
2-9/16	11/64	1-3/32	3/4	1/2	2-3/4	49560	\$115.36

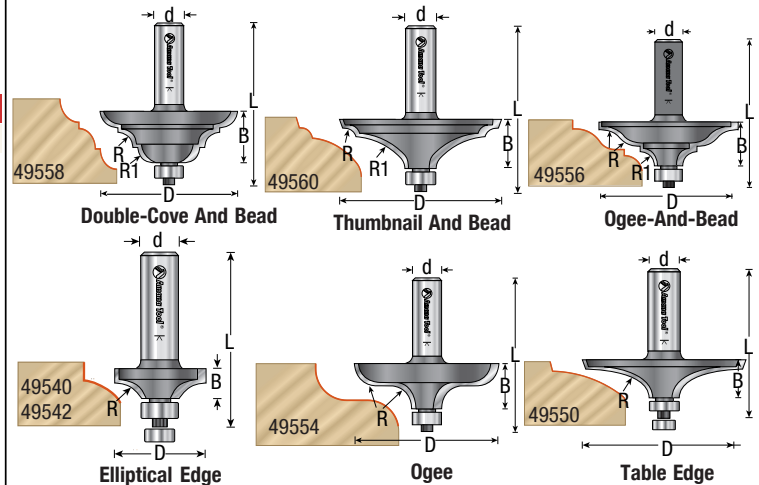

AMANA TABLE EDGE BITS

With Ball Bearing Guide

ØD	R	R1	B	Ød	L	Tool No.	Price
2-21/64	1/2	1/4	55/64	1/2	2-3/4	49555	\$125.93
2-7/64	1/4	7/16	27/32	1/2	2-3/4	49557	\$113.30
1-5/32	3/8	5/16	7/8	1/2	2-3/4	49559	\$125.93
2	3/8	1/4	55/64	1/2	2-3/4	49561	\$139.44
2-3/8	1/16	—	27/32	1/2	2-25/32	49563	\$140.56

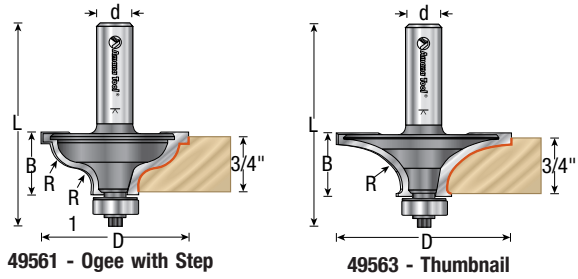
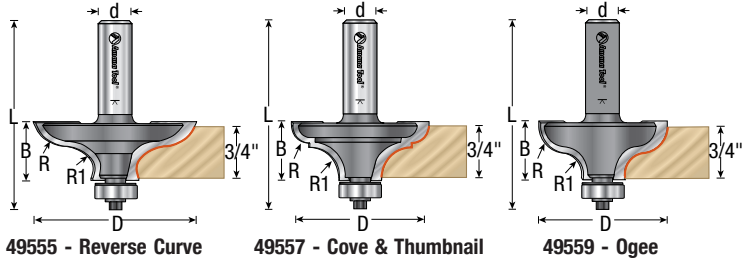

HANDRAIL With Ball Bearing Guide

Carbide Tipped • 2 Flute

Ø	R	R1	B	Ø	L	Tool	Price
1-3/8	1/8	19/32	1-1/2	1/2	3-3/8	54262	\$88.20
1-1/4	3/8	1	1-1/2	1/2	3-3/8	54268	\$75.64
1-1/4	3/8	1/2	1-1/2	1/2	3-3/8	54269	\$75.64

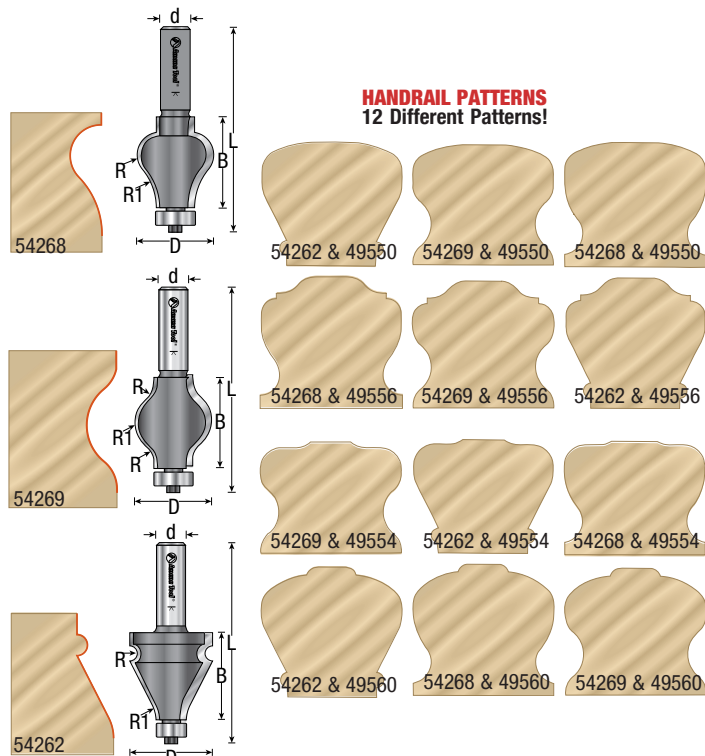

3D renderings & tool illustrations not shown at actual size.

DOVETAIL

7° Angle • Carbide Tipped

ØD	B	Ød	L	Application	Tool No.	Price
9/32	1/2	1/4	2-13/32	Porter-Cable® Jig 4212	45837	\$12.71
17/32	25/32	1/2	2-3/16	Porter-Cable® Jig 4210 & 4212	45838	\$14.42
3/4	7/8	1/2	2-5/8	Incra®	45810	\$35.50
7/8	7/8	1/2	2-1/2	Stair Tread	45812	\$32.52

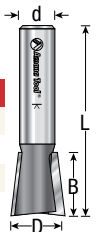

DOVETAIL

9° Angle • Carbide Tipped

ØD	B	Ød	L	Tool No.	Price
5/16	3/8	1/4	2-1/2	45822	\$22.09
5/16	3/8	1/2	2-1/2	45823	\$22.09
3/8	3/8	1/4	2	45800	\$16.91
3/8	3/8	3/8	2	45801	\$17.89
3/8	3/8	1/2	2	45802	\$17.89

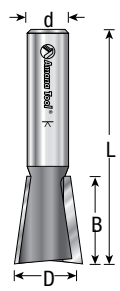

10° Angle • Carbide Tipped

ØD	B	Ød	L	Application	Tool No.	Price
1/2	5/8	1/2	2-5/8	Incra®	45805	\$25.27

14° Angle • Carbide Tipped

ØD	B	Ød	L	Application	Tool No.	Price
1/2	1/2	1/4	1-3/4	—	45804	\$16.91
1/2	1/2	1/4	2	Incra®/Omnijig® 43705	45832	\$13.86
1/2	.532	1/2	2-1/2	Incra®/Omnijig® 43750	45806	\$19.04
17/32	1/2	1/4	2	Incra®	45834	\$13.79
3/4	3/4	1/2	3	Omnijig® 43774	45816	\$36.26
7/8	7/8	1/2	2-5/8	—	45818	\$36.26
1	1	1/2	2-3/4	—	45814	\$31.99

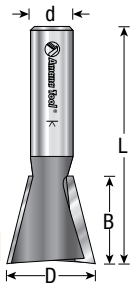

18° Angle • Carbide Tipped

ØD	B	Ød	L	Application	Tool No.	Price
1/2	.415	1/4	2-1/4	Leigh® #128	45835	\$16.87

14° BUTTERFLY SPLINE Carbide Tipped • 2 Flute

ØD	B	Ød	L	Tool No.	Price
1-1/8	1-3/4	1/2	3-1/4	45860	\$56.35

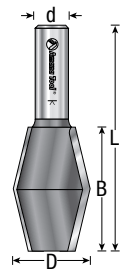
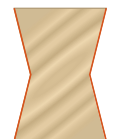

14° DOVETAIL

With Upper Ball Bearings

Carbide Tipped • 2 Flute

ØD	B	Ød	L	Type	Tool No.	Price
1/2	1/2	1/4	2-1/4	Dovetail	45850	\$28.32
3/4	3/4	1/2	3	Dovetail	45852	\$49.49

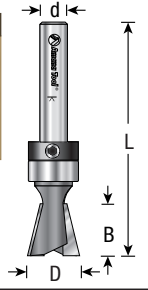
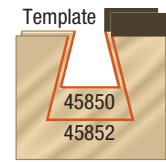

7° STAIRTREAD

Carbide Tipped • 2 Flute

ØD	Rotation	B	Ød	L	Tool No.	Price
3/4	Right Hand	7/8	1/2	2-5/8	45810	\$33.50
7/8	Right Hand	7/8	1/2	2-1/2	45812	\$32.52

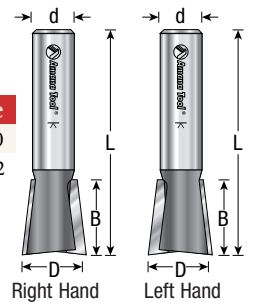

AMANA KELLER™ DOVETAIL SYSTEM

Carbide Tipped
Straight Cutter W/Upper Ball Bearing

ØD	B	Ød	L	Keller™ No.	Tool No.	Price
.615	3/4	1/4	2-5/8	1643/2443	45470	\$16.56
.615	1/2	1/4	2-1/4	1641	45476	\$22.19
9/16	3/4	1/4	2-1/4	3032	45479	\$22.19

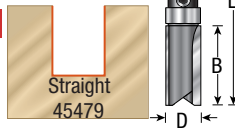

E-Z DIAL™ SLOT CUTTERS

Carbide Tipped

ØD	B	C	Ød	L	Tool No.	Price
2-1/8	1/8 to 1/4	1/2	1/2	3-3/4	55500	\$126.70
2-1/8	1/4 to 1/2	1/2	1/2	3-3/4	55510	\$126.70

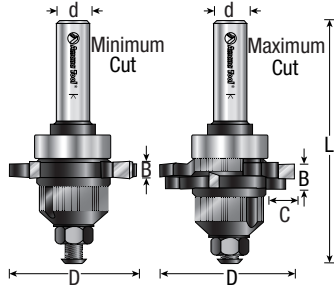
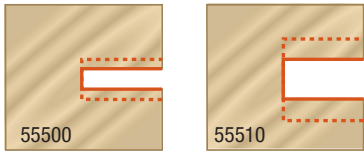

SLOTting CUTTER ASSEMBLIES

Carbide Tipped

ØD	B	C	Ød	L
1-7/8	Kerf (from 1/6 to 1/4)	1/2	1/4 or 1/2	2-3/8

B	1/4" Shank		1/2" Shank	
	2-Wing Tool No.	Price	3-Wing Tool No.	Price
1/16	53300	\$21.25	53400	\$22.58
5/64	53302	\$21.25	53402	\$22.86
3/32	53304	\$22.02	53404	\$23.03
1/8	53306	\$22.02	53406	\$24.50
5/32	53307	\$22.33	53407	\$25.10
3/16	53308	\$22.33	53408	\$25.10
7/32	53309	\$22.72	53409	\$25.20
1/4	53310	\$22.72	53410	\$25.20

Replacement Arbor	Tool No.	Price
1/4" Shank	47600	\$3.85
3/8" Shank	47602	\$3.85
1/2" Shank	47604	\$3.85

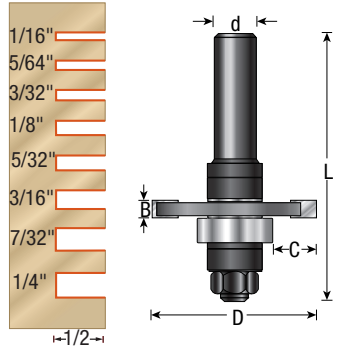
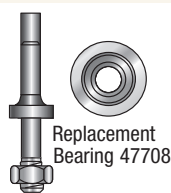

SLOT CUTTER 'VARI-DEPTH'™ BEARINGS

Carbide Tipped

'C' Depth of Cut	I.D.	O.D.	Tool No.	Price
1/4	5/16	1-3/8	47727	\$9.03
3/8	5/16	1-1/8	47728	\$9.31
Two piece set (#47727 & #47728)			47729	\$17.08

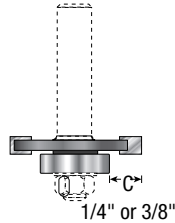

3D renderings & tool illustrations not shown at actual size.

2 & 3 WING SLOTting CUTTERS

Carbide Tipped

ØD	B	Ød1	2 Wing Tool No.	Price	3 Wing Tool No.	Price
1-7/8	1/16	5/16	53100	\$13.30	53200	\$15.40
1-7/8	5/64	5/16	53102	\$13.30	53202	\$15.40
1-7/8	3/32	5/16	53104	\$14.07	53204	\$15.86
1-7/8	1/8	5/16	53106	\$14.07	53206	\$17.36
1-7/8	5/32	5/16	53107	\$14.35	53207	\$17.92
1-7/8	3/16	5/16	53108	\$14.35	53208	\$17.92
1-7/8	7/32	5/16	53109	\$17.50	53209	\$19.99
1-7/8	1/4	5/16	53110	\$14.98	53210	\$18.20

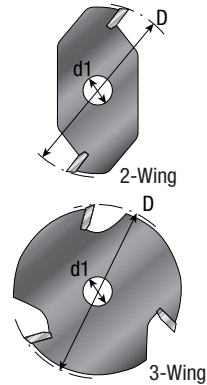

QUADRASET™ ADJUSTABLE SLOTting ASSEMBLY

With Ball Bearing Guide

Carbide Tipped • 2-Wing

ØD	A	B-Kerf	Ød1	Ød	L	Tool No.	Price
1-7/8	1/2	1/8 to 23/32	5/16	1/2	3	53600	\$84.18
						53107	\$14.35

Extra 5/32 two-wing cutter only.

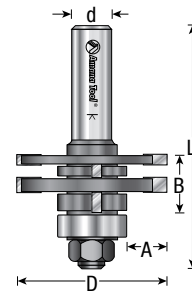

53106	1/8"
53107	5/32"
53108	3/16"
53110	1/4"

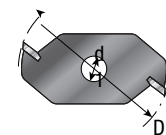

'BOX JOINT' SET

With Ball Bearing Guide

Carbide Tipped • 3-Wing

ØD	B	B1	Ød	L	Tool No.	Price
1-7/8	1-3/8	5/32	1/2	3-3/4	53610	\$102.59

Individual Components:

Description	Order #	Price
5/32" 3-Wing Cutters (5 required)	53207	\$17.92
1/2" Shank Arbor With Nut	47620	\$11.06
Steel Ball Bearing Guide (1/2" depth of cut)	47708	\$4.31
5.5mm Spacers (4 required)	55369	\$0.98
1mm Spacers (2 required)	55402	\$0.74
.5mm Shim (1 required)	55404	\$1.05

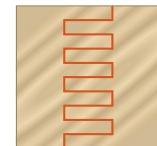
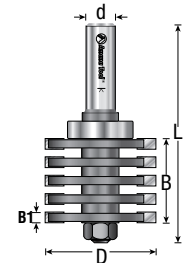

RAISED PANEL 'V' JOINT

Carbide Tipped

ØD	B	a°	Ød	L	Tool No.	Price
1-3/8	1-37/64	80°	1/2	3-1/16	45790	\$60.13

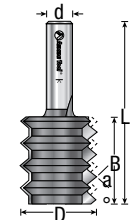

DRAWER LOCK

Carbide Tipped • 2 Flute

ØD	ØD1	B	B1	Ød	L	Tool No.	Price
3/4	1/2	1/2	5/32	1/4	1-5/16	55386	\$36.96

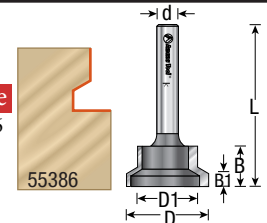

AMANA FINGER JOINT ASSEMBLY With Ball Bearing Guide

Carbide Tipped • 2-Wing

ØD	B	Ød	L	Tool No.	Price
1-9/16	1-3/8	1/2	3-3/4	55392	\$104.44

Overall Specs:

Individual Components Description	Order #	Price
Finger Cutter (5 required)	55394	\$20.02
Straight Cutter (1 required)	55396	\$20.02
Ball Bearing (5/6" x 28mm)	47736	\$7.56
1/2" Shank Arbor With Nut	47620	\$11.06
3.4mm Spacer (7 required)	55367	\$1.05
6.0mm Spacer (1 required)	55368	\$1.05
0.1mm Shim (10 required)	55357	\$1.09
0.5mm Shim (1 required)	55404	\$17.61
1.0mm Washer (2 required)	55402	\$0.74

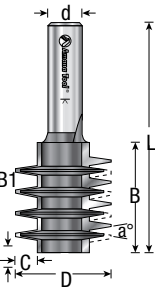
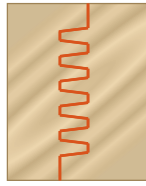
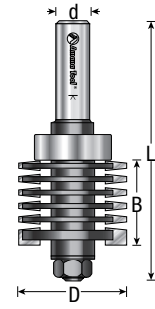

FINGER JOINT Carbide Tipped

ØD	B	B1	a°	C	Ød	L	Tool No.	Price
1-3/8	1-9/16	21/64	14°	5/16	1/2	3	45796	\$64.09



45° LOCK MITER Carbide Tipped • 2 Flute

ØD	D1	B	a°	Ød	L	Size	Material Tool No.	Price
1-1/2	12.1mm	1/2	45°	1/4	1-5/8	5/16-7/16	55393	\$76.30
1-5/8	13.2mm	5/8	45°	1/4	1-3/4	3/8-1/2	55391	\$80.29
1-3/4	6.4mm	7/8	45°	1/2	2-1/8	3/8-3/4	55389	\$88.73
2-11/16	9.2mm	1-3/16	45°	1/2	2-5/8	1/2-1-1/8	55390	\$124.74

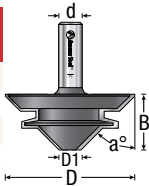

22.5° LOCK MITER SET Carbide Tipped • 2 Flute

ØD	B	a°	Ød	L	Tool No.	Price
1-15/32	7/8	22.5°	1/2	2-1/2	55395	\$112.77

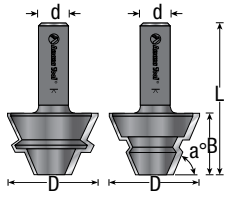

GLUE JOINT Carbide Tipped • 2 Flute

ØD	ØD1	B	Ød	L	Tool No.	Price
1-7/8	1-7/16	1-3/32	1/2	2-5/8	55388	\$82.22

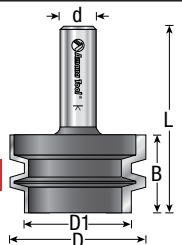

TONGUE & GROOVE ASSEMBLY With Ball Bearing Guide

3/8" to 1-1/8" Material • Carbide Tipped • 2-Wing

ØD	B	B1	C	Ød	t	L	Tool No.	Price
1-5/8	3/4	1/4	3/8	1/2	1/4	3	55400	\$63.84
1-5/8	1-1/8	3/8	3/8	1/2	3/8	3-3/8	55401	\$79.24

Tongue is cut as shown in assembly 'A'. For groove cut, reassemble the tool as shown in assembly 'B'. Instructions included.

3D renderings & tool illustrations not shown at actual size.

2 PIECE EDGE BANDING SETS

Carbide Tipped • 2 Flute

ØD	ØD1	B	B1	a°	a1°	Ød	L	Tool No.	Price
1-25/32	1-13/16	1-1/32	—	90°	—	1/2	2-21/32	55466	\$121.24
1-19/32	1-45/64	1	5/32	30°	60°	1/2	2-5/8	55468	\$121.24

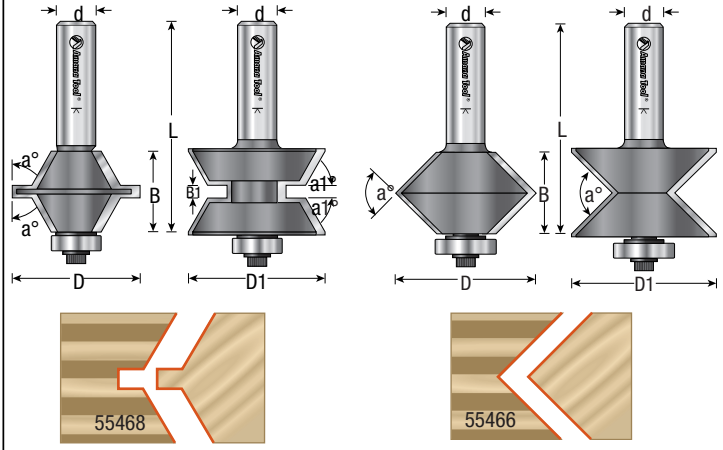

MULTI-SIDED GLUE JOINT/ BIRD'S-MOUTH

Carbide Tipped • 2 Flute

ØD	B	# Sides	a°	Ød	L	Tool No.	Price
1-5/8	1-1/4	16	67.5°/22.5°	1/2	2-7/8	54270	\$54.43
1-3/4	1-3/64	8	45°/45°	1/2	2-21/32	54272	\$50.61
1-7/8	1-1/4	6 or 12	60°/30°	1/2	2-7/8	54274	\$58.38

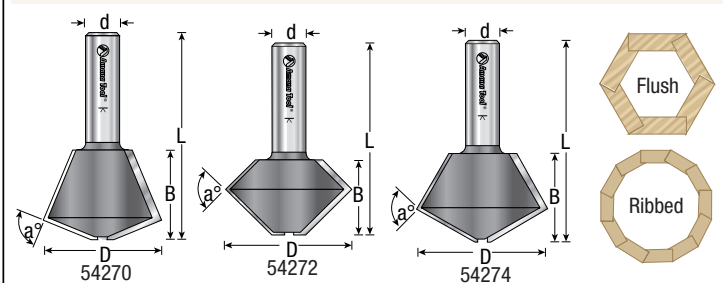

2-Piece Sets

ØD	B	B1	C	Ød	t	L	Tool No.	Price
1-5/8	17/32	13/64	3/8	1/2	1/8	3	55408	\$110.22
1-7/8	3/4	1/4	1/2	1/2	1/4	3	55407	\$114.38

Replacement Parts:

Description	Order #
1/4" Kerf Cutters (2 required) for Tool #55400	55354
3/8" Kerf Cutters (2 required) for Tool #55401	55353
1/2" Shank Arbor With Nut For Tool #55400	47612
1/2" Shank Arbor With Nut For Tool #55401	47613
Ball Bearing Guide (2 required)	47708
.05mm Shims (3 required)	55356
.10mm Shims (3 required)	55357
1mm Black Washer	55402
6mm Steel Spacer	55368

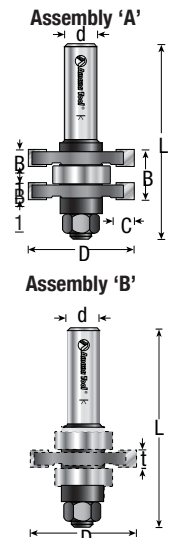
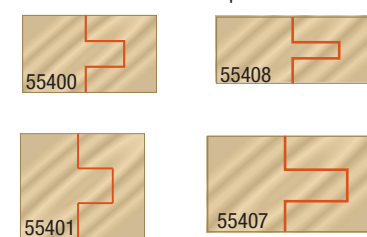

AMANA WEDGE TONGUE & GROOVE

Carbide Tipped • 2 Flute

ØD	ØD1	a°	B	B1	Ød	L	Description	Tool No.	Price
1-1/4	9/16	15°	1-1/4	1/4	1/2	2-3/4	Wedge Groove	55410	\$66.89
1-1/4	9/16	15°	1-1/4	7/16	1/2	2-3/4	Wedge Tongue	55412	\$76.37
Complete Wedge T & G (2 piece set)								55414	\$134.82

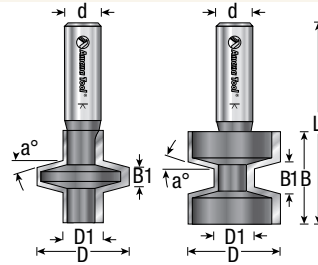

ADJUSTABLE 'V' PANEL SET

Carbide Tipped • 2 Flute

ØD	ØD1	B	B1	Ød	L	Tool No.	Price
1-11/64	1-37/64	1-1/8	5/32 to 5/16	1/2	3-3/8	55346	\$164.22

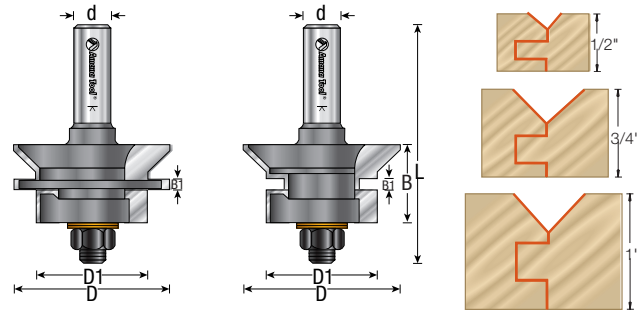

OGEE WINDOW SASH & RAIL

With Ball Bearing Guide

Carbide Tipped • 2 Flute

ØD	R	'A' Reveal	B	B1	B2	B3	Ød	L	Tool No.	Price
1-3/8	1/8	1/4	1-13/16	5/16	5/8	7/8	1/2	3-3/4	55340	\$148.05
1-3/8	1/8	—	21/32	1/16	27/64	—	1/2	2-1/8	55341	\$58.98
1-9/64	1/8	—	43/64	5/16	—	—	1/2	2-1/8	55343	\$70.25

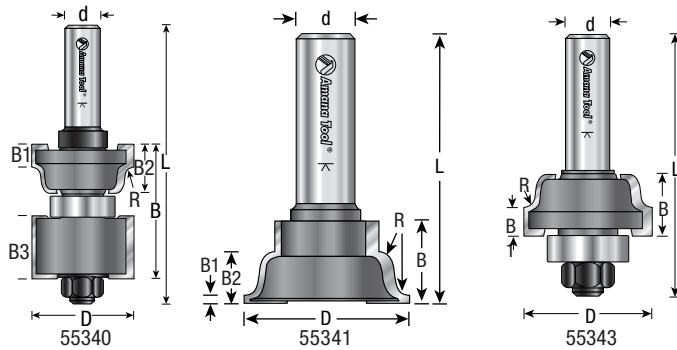

SOLID WOOD TONGUE AND GROOVE FLOORING SETS With Nail Slot

Carbide Tipped • 2 Flute

Material	ØD	ØD1	a°	a1°	R	R1	T	C	C1	B	d	L	Tool No.	Price
1/2 to 5/8	1-1/4	15/16	45°	60°	—	—	13/64	.163	.197	3/4	1/2	2-3/4	55454	\$117.11
5/8 to 3/4	1-13/64	1	45°	—	1/8	1/16	1/4	1/4	—	15/16	1/2	2-7/8	55456	\$122.50

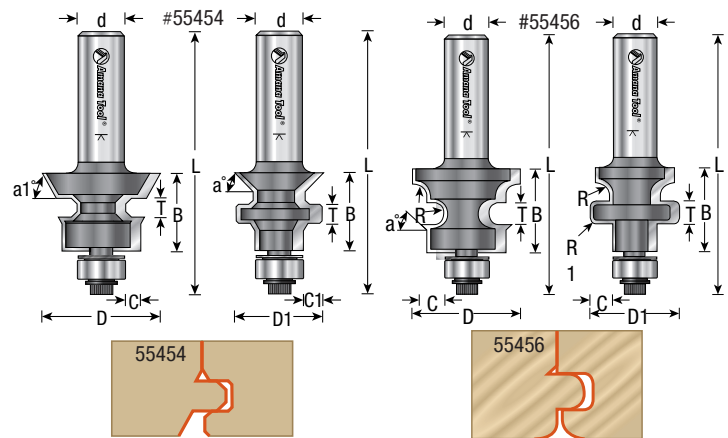

BEAD AND 'V' PANELING ASSEMBLY

With Ball Bearing Guide

Carbide Tipped • 2-Wing

ØD	ØD1	R	a°	B	Ød	L	Type	Tool No.	Price
1-13/16	1-5/16	—	45°	1/2 to 1-3/16	1/2	3-1/8	'V'	55320	\$164.71
1-15/16	1-5/16	1/4	—	1/2 to 1-3/16	1/2	3-1/8	Bead	55330	\$164.71

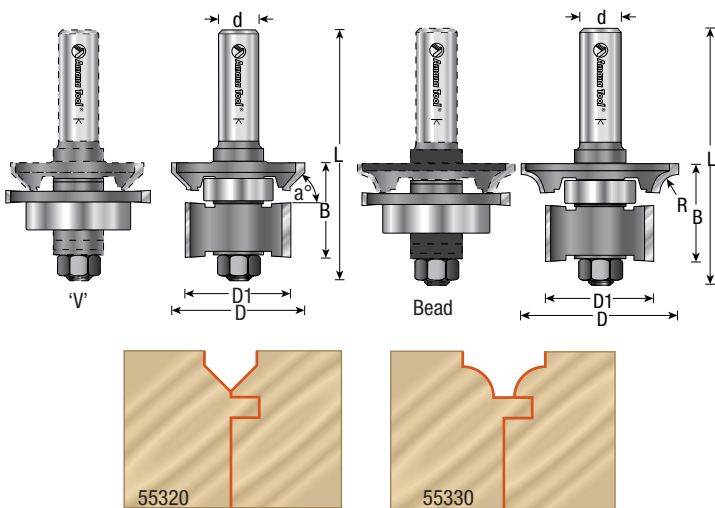

FLUSH TRIM PLUNGE TEMPLATE

With Upper Ball Bearing
Carbide Tipped • 2 Flute
1/4" Shank

ØD	B	Ød	L	Replacement Bearing Collar	Tool No.	Price
1/2	1/4	1/4	1-5/8	47701 47724	45460-S	\$25.06
1/2	1/2	1/4	1-15/16	47706	—	47174 \$19.32

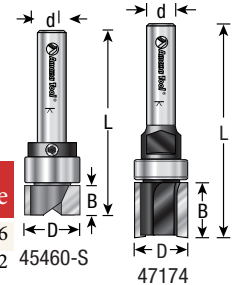

VERTICAL RAISED PANEL

Carbide Tipped • 2 Flute

ØD	ØD1	B	a°	R1	R2	R3	Ød	L	Type	Tool No.	Price
1-3/16	7/16	1-5/8	—	7/8	23/32	—	1/2	3-1/8	Ogee	54520	\$69.93
1-1/8	9/32	1-5/8	—	1-9/16	—	—	1/2	3-1/8	Cove	54524	\$69.93
1-3/16	3/16	1-5/8	—	7/8	23/32	1/8	1/2	3-1/8	Ogee w/Bead	54528	\$69.93
1-1/8	19/32	1-5/8	15°	—	—	—	1/2	3-1/8	Traditional	54532	\$69.93

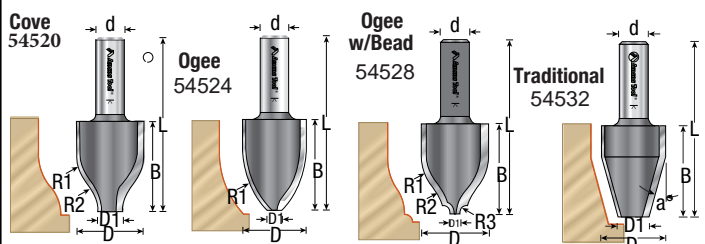

3D renderings & tool illustrations not shown at actual size.

AMANA FLAT PANEL STILE & RAIL SETS

With Ball Bearing Guide

Carbide Tipped 5/8" to 1-1/4" Material

ØD	R	a°	B to B1	C	Ød	L	Type	Tool No.	Price
1-5/8	5/32	—	5/8 to 1-1/4	3/8	1/2	3-11/32	Concave	55433	\$198.56
1-5/8	1/4	—	5/8 to 1-1/4	3/8	1/2	3-11/32	Ogee	55436	\$198.56
1-5/8	3/16	—	5/8 to 1-1/4	3/8	1/2	3-11/32	Bead	55437	\$198.56
1-5/8	—	—	5/8 to 1-1/4	3/8	1/2	3-11/32	Mission (Straight)	55438	\$154.81
1-7/8	—	—	5/8 to 1-1/4	1/2	1/2	3-11/32	Mission (Straight)	55439	\$162.44
1-7/8	—	18°	5/8 to 1-1/4	1/2	1/2	3-11/32	Straight with Bevel	55432	\$178.47

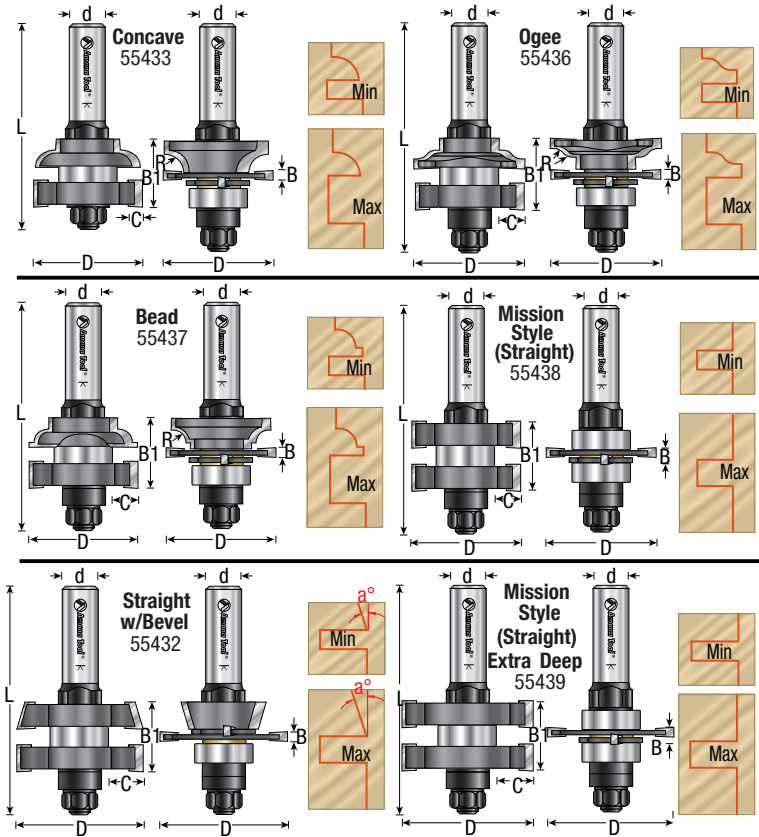

2-PIECE STILE & RAIL SETS

With Ball Bearing Guide

Carbide Tipped • 2-Wing
3/4" Material

ØD	R	B	B1	Ød	L	Type	Tool No.	Price
1-5/8	1/4	11/16	1/4	1/2	3-1/8	Concave	55421	\$132.23
1-5/8	1/4	11/16	1/4	1/2	3-1/8	Ogee	55431	\$132.23
1-5/8	3/16	11/16	1/4	1/2	3-1/8	Bead	55441	\$132.23

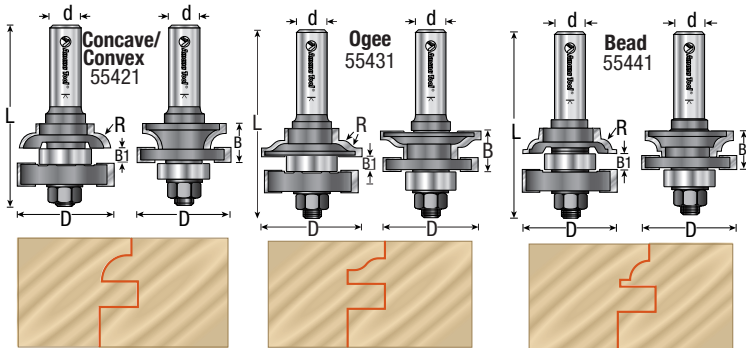

3D renderings & tool illustrations not shown at actual size.

2-PIECE STILE & RAIL SETS

With Ball Bearing Guide

Carbide Tipped • 2-Wing • 3/4" to 1" Material

ØD	R	B	B1	Ød	L	Type	Tool No.	Price
1-5/8	1/4	1-1/16	1/4	1/2	3-5/16	Concave	55420	\$110.78
1-5/8	1/4	1-1/16	1/4	1/2	3-5/16	Ogee	55430	\$110.78
1-5/8	3/16	1-1/16	1/4	1/2	3-5/16	Bead	55440	\$139.65

Individual Components: Description	Qty. Required for Tool No.			Order #	Price
	55420	55430	55440		
Concave Profile Cutter	1	—	—	55422	\$73.43
Concave Cope Cutter	1	—	—	55424	\$73.43
Ogee Profile Cutter	—	1	—	55352	\$87.89
Ogee Cope Cutter	—	1	1	55434	\$73.43
Bead Profile Cutter	—	—	1	55442	\$73.43
Bead Cope Cutter	—	—	1	55444	\$73.43
.250" Groove Cutter	1	1	1	55354	\$23.94
.300" Trim Cutter (.865" dia.)	1	1	1	55448	\$23.56
.433" Trim Cutter (.865" dia.)	1	1	1	55450	\$25.48
.400" Rabbet Cutter (1.615" dia.)	1	1	1	55452	\$32.66
.865" Ball Bearing	2	2	2	47708	\$4.31
1/2" Shank Arbor With Nut	2	2	2	47622	\$12.15
.002" Shims	4	4	4	55356	\$1.09
.040" Shims	4	4	4	55402	\$0.74
.004" Shims	4	4	4	55357	\$1.09
3.6mm Spacers	4	4	4	55367	\$1.05

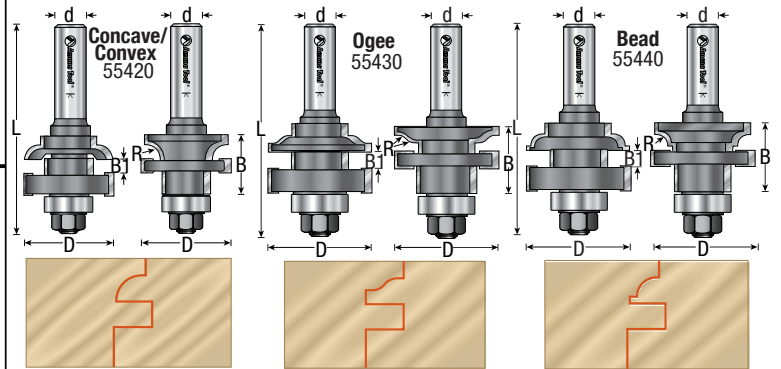

REVERSIBLE STILE & RAIL ASSEMBLIES

With Ball Bearing Guide

Carbide Tipped • 2-Wing • 3/4" Material

ØD	Pattern Type	'A'		B	B1	Ød	L	Tool No.	Price
		Reveal							
1-5/8	Ogee	3/8		11/16	7/8	1/2	3	55350	\$109.66
1-5/8	Traditional	3/8		11/16	7/8	1/2	3	55370	\$109.66
1-5/8	Classical	3/8		11/16	7/8	1/2	3	55380	\$109.66

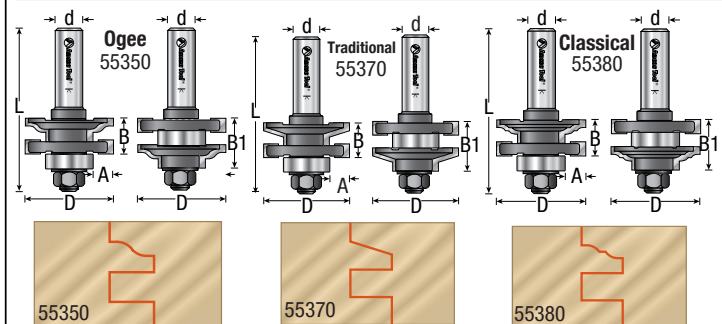

AMANA
RAISED PANEL
With Ball Bearing Guide

Carbide Tipped • 2 Flute
Architectural

ØD	*A' Reveal	R	R1	R2	B	Ød	L	Tool No.	Price
3-9/16	*1-17/32	5/32	1-23/32	57/64	1/2	1/2	2-1/4	54113	\$129.54

Traditional

ØD	*A' Reveal	a°	B	B1	Ød	L	Tool No.	Price
1-5/8	*9/16	25°	1/2	—	1/2	2-3/8	54116	\$48.86
3-3/8	*1-7/16	15°	1/2	5/16	1/2	2-3/8	54117	\$99.86

Cove

ØD	*A' Reveal	R	B	Ød	L	Tool No.	Price
3-3/8	*1-7/16	1-9/16	1/2	1/2	2-3/8	54119	\$98.18

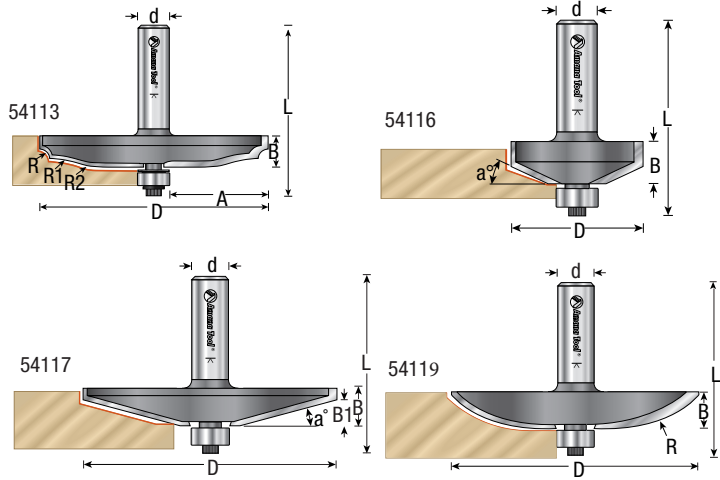

RAISED PANEL
With Ball Bearing Guide
Ogee

ØD	*A' Reveal	R	B	B1	Ød	L	Tool No.	Price
2-5/8	*1-1/16	3/4	5/8	5/16	1/2	2-1/2	54118 Δ_{20}	\$74.27
3-3/8	*1-7/16	7/8	9/16	3/8	1/2	2-1/2	54121 Δ_{14}	\$98.18

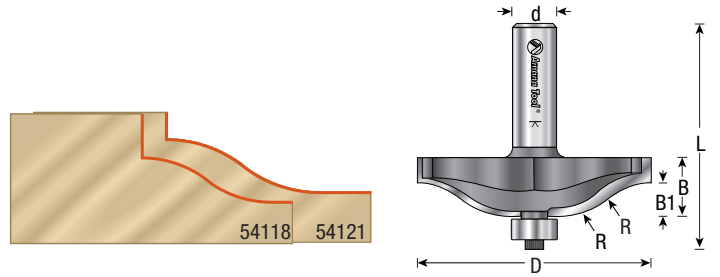

RAISED PANEL
With Back Cutter

Carbide Tipped • 2 Flute With Ball Bearing Guide
Traditional

ØD	ØD1	Reveal	'A1'	a°	R	B	B1	Ød	L	Tool No.	Price
3-3/8	2-1/8	1-3/8	1-1/16	15°	5/16	1-1/16	1/2	1/2	2-15/16	54227	\$149.03

Ogee

ØD	ØD1	Reveal	'A1'	R	R1	B	B1	Ød	L	Tool No.	Price
3-3/8	2-1/8	1-3/8	1-1/16	7/8	5/16	1-3/16	5/8	1/2	3-1/16	54221	\$149.03

Cove

ØD	ØD1	Reveal	'A1'	R	R1	B	B1	Ød	L	Tool No.	Price
3-3/8	2-1/8	1-3/8	1-1/16	1-9/16	5/16	1-1/16	1/2	1/2	2-15/16	54229	\$149.03

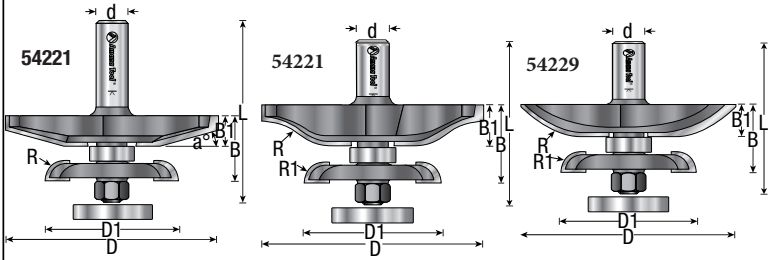

Divided Light Router Bit Set

Carbide Tipped • 2 Flute • 3/4" To 7/8" Material

ØD	ØD1	B	B1	R	Ød	L	Tool No.	Price
2-1/8	1-1/4	1	1/4	3/16	1/2	3-1/8	55360	\$141.30

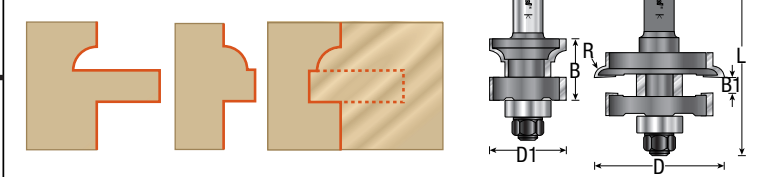

Carbide Tipped • 2 Flute • 7/8" To 1-1/2" Material

ØD	ØD1	B	B1	R	Ød	L	Tool No.	Price
2-3/16	1-7/16	1-5/8	1/4	1/4	1/2	3-3/4	55362	\$199.61

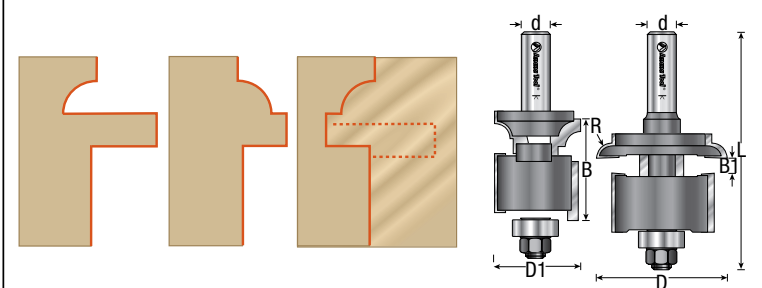

ARCHITECTURAL DOOR

With Ball Bearing Guide
Carbide Tipped • 2 Flute

ØD	B	B1	R	R1	R2	C	A	T	Ød	L	L1	Type	Tool No.	Price
1-15/32	1	55/64	1/4	5/64	—	1/2	—	7/32	1/2	2-1/2	2-15/64	Stile & Rail Set	55428	\$133.70
3-9/16	1/2	—	5/32	1-23/32	57/64	—	1-17/32	—	1/2	2-1/4	—	Raised Panel	54113	\$129.54
1-1/4	7/16	—	7/32	9/64	—	—	—	—	1/2	1-15/16	—	Door Edge	49534	\$54.29

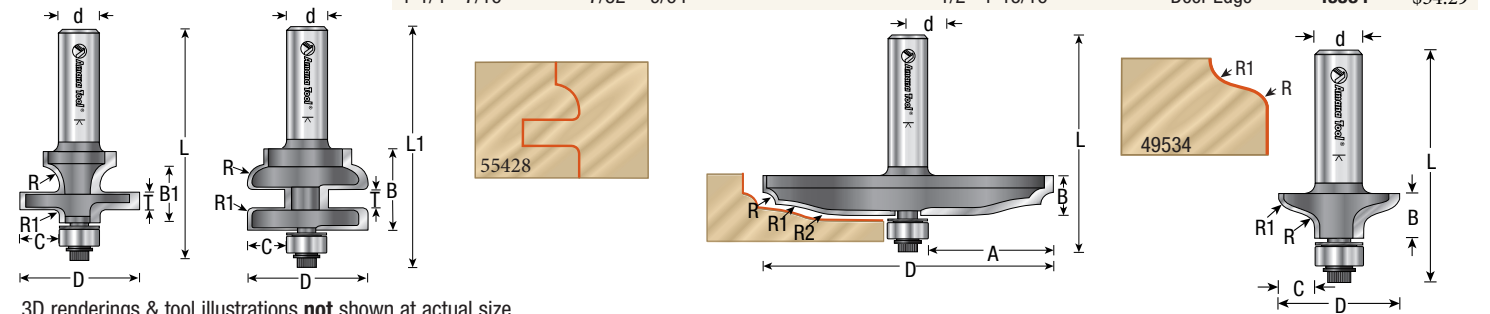

3D renderings & tool illustrations not shown at actual size.

AMANA ENTRY DOOR SYSTEM

Carbide Tipped • 2 Flute • 1-3/4" Material

ØD	ØD1	B	R	Ød	L	Type	Tool No.	Price
2	3/4	5/8	11/32	1/2	2	Cope Cutter w/Stub Spindle	47511	\$61.81
1-3/4	—	11/16	11/32	1/2	2-3/16	Ogee Bit	54131	\$55.13

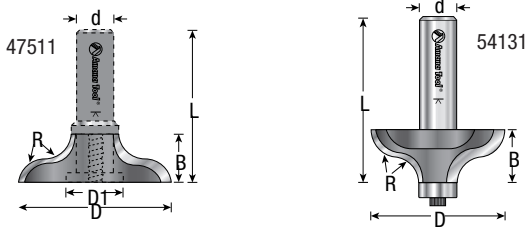

CABINET DOOR SYSTEM

Carbide Tipped • 2 Flute • 7/8" Material

ØD	ØD1	B	R	Ød	L	Type	Tool No.	Price
1-5/8	3/4	3/8	1/4	1/2	2	Cope Cutter w/Stub Spindle	47515	\$53.24
1-3/8	—	3/8	1/4	1/2	1-31/32	Ogee Bit	54175	\$46.52

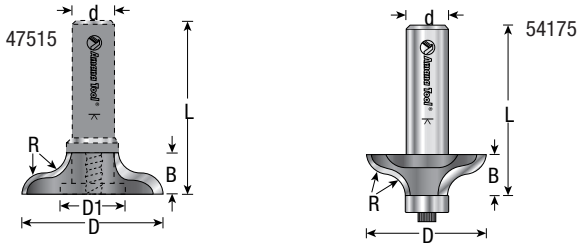

HISTORICAL SHAKER DOOR

Carbide Tipped • 2 Flute
7/8" Frame Material And
5/8" Panel Material

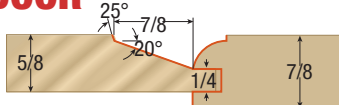

ØD	D1	B	R	B1	Ød	L	Type	Tool No.	Price
2-13/16	1	1/2	—	—	1/2	2-1/64	Raised Panel	54133	\$134.89
1-5/8	1-1/2	7/8	3/8	1/4	1/2	3-1/2	2 Piece Set	55426	\$160.86

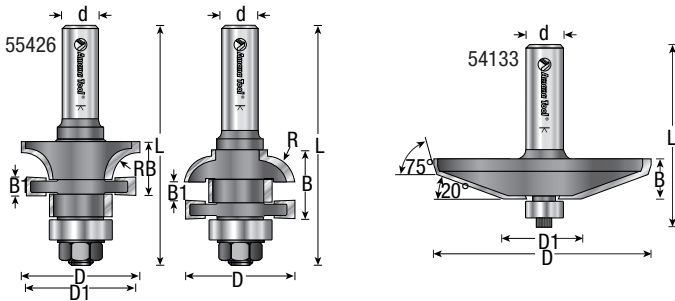

OFFSET MORTISE-AND-TENON

For Mission Style Glass Door

Carbide Tipped • 2 Flute
3/4" To 1-1/8" Material

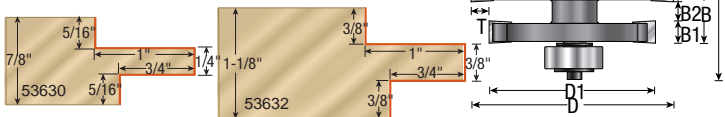

Ø	ØD1	B	B1	B2	T	Ød	L	Use Mortise	Tool No.	Price
2-7/8	2-3/8	7/8	5/16	1/4	1/4	1/2	2-3/8	609-100	53630	\$81.27
2-7/8	2-3/8	1-1/8	3/8	3/8	1/4	1/2	2-5/8	609-120	53632	\$86.56

3D renderings & tool illustrations not shown at actual size.

LOUVER/SHUTTERS

With Ball Bearing Guide

Carbide Tipped • 2 Flute

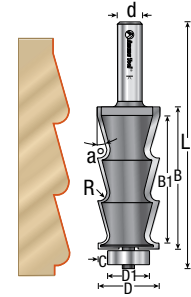

Ø	ØD1	R	B	B1	C	a°	Ød	L	Tool No.	Price
1-1/4	22mm	5/32	2-29/32	2-9/32	3/16	15°	1/2	4-3/4	54246	\$103.11

PROFILE SETS

For Glass Doors, Window, Paneling
And Many Other Joinery Applications

Carbide Tipped • 2 Flute With Ball Bearing Guides

	Tool No.	Price
2-Piece Bead Set Including 49640 & 49642	49643	\$46.27
2-Piece Bead Set Including 49644 & 49646	49647	\$50.16
2-Piece Window Stile & Rail Set Including 49650 & 49652	49653	\$54.01
2-Piece Ogee Stile & Rail Set Including 49660 & 49662	49663	\$61.71
2-Piece Ogee Stile & Rail Set Including 49664 & 49666	49667	\$66.36
2-Piece Classical Stile & Rail Set Including 49670 & 49672	49673	\$47.85
2-Piece Classical Stile & Rail Set Including 49674 & 49676	49677	\$54.81

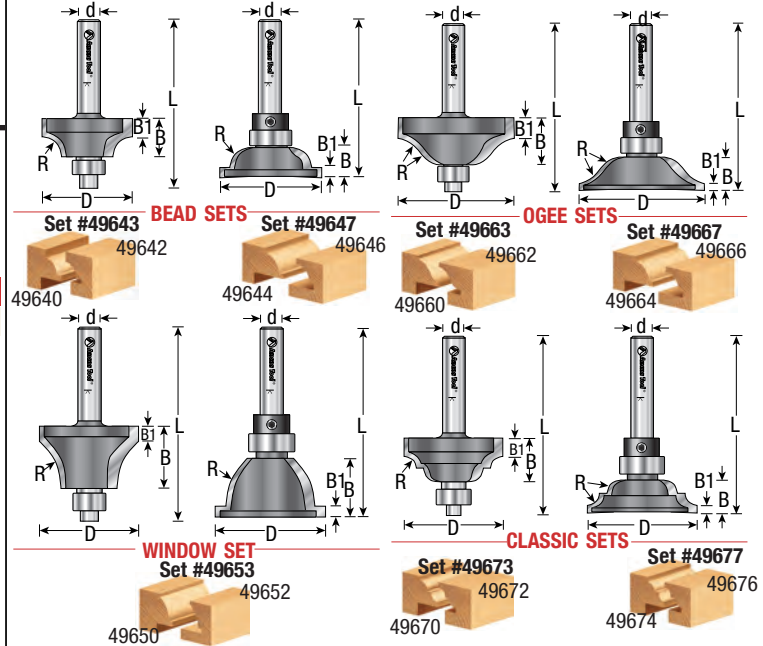

WINDOW SILL EDGE

Carbide Tipped • 2 Flute

ØD	D1	R	R1	B	B1	C	Ød	L	Tool No.	Price
1-7/16	5/8	3/8	5/16	1-1/8	1	13/32	1/2	3-7/8	53824	\$52.01
1-1/4	3/8	7/32	11/32	1	7/8	5/16	1/2	3	53826	\$52.01
1-7/16	11/16	23/64	9/16	1-3/8	1-1/4	3/8	1/2	3-3/8	53828	\$64.86

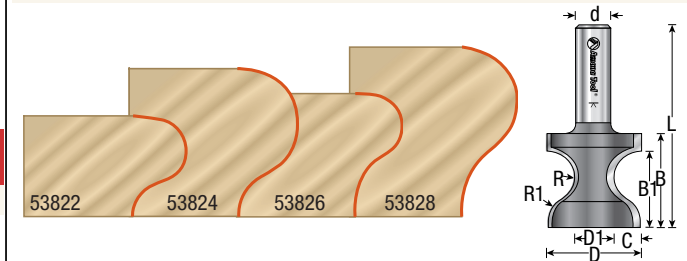

AMANA FINGER GRIP (Drawer Pull, Door Lip, Etc.)

Carbide Tipped • 2 Flute

ØD	ØD1	ØD2	R	R1	B	B1	Ød	L	Tool No.	Price
3/4	—	—	1/4	—	1/4	—	1/4	1-3/4	53800	\$30.68
3/4	25/64	—	7/64	3/16	3/4	39/64	1/2	2-1/4	53806	\$85.86
1-1/2	11/16	—	5/64	15/64	13/16	45/64	1/2	2-5/16	53808	\$106.89
1-3/4	11/16	—	7/64	13/64	13/16	11/16	1/2	2-5/16	53810	\$115.08
2	3/4	—	1/4	3/16	1-1/4	—	1/2	2-3/4	53812	\$107.91

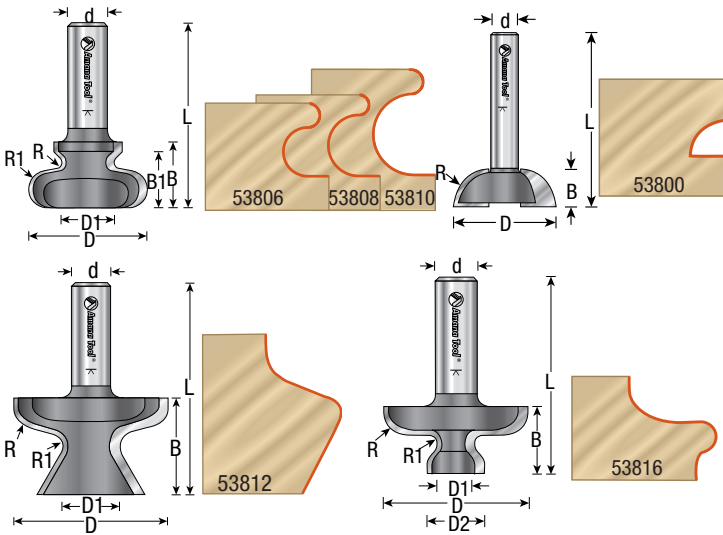

DOOR EDGE DETAIL For DECO Door

Carbide Tipped • 2 Flute

ØD	ØD1	ØD2	R	R1	B	Ød	L	Tool	Price
2	23/32	31/32	3/8	1/8	1-3/16	1/2	2-1/2	53820	\$114.10
1-3/4	—	—	3/8	1/8	11/16	1/2	2-5/8	49562	\$63.81

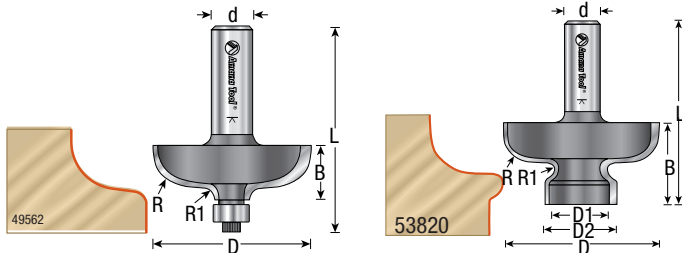

DOOR LIP ASSEMBLY

Carbide Tipped • 2 Flute
Corner Round & Taper Rabbet •
Complete Assembly

ØD	R	a°	B	Ød	L	Tool No.	Price
1-9/16	3/8	10°	1	1/2	3	55300	\$66.96

Replacement Parts:

Description	Tool No.	Price
10° Taper Rabbet Cutter	55304	\$33.18
1/2" Shank Arbor With Nut	47612	\$5.71

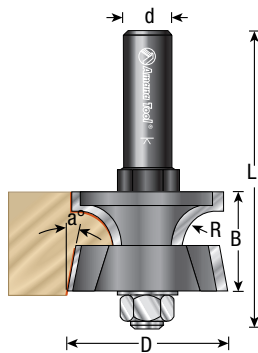

FOR FABRICATING SOLID SURFACE MATERIALS

Wilsonart®, Gibraltar®, Corian®, Surell®,
Fountainhead®, Avonite®, Etc.

COUNTER-TOP 'NO-DRIP' DESIGN With Ball Bearing Guide

Carbide Tipped • 2 Flute

ØD	ØD1	A	R	B	B1	Ød	L	Tool No.	Price
1	3/4	1/2	5/16	7/8	5/8	1/2	3	57118	\$70.39
1	3/4	3/4	5/16	1-1/8	15/16	1/2	3-1/4	57120	\$76.83

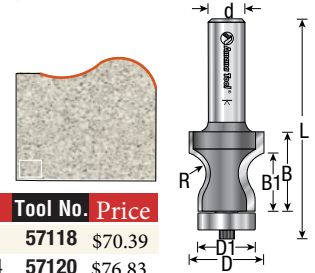

COUNTER-TOP 'NO-DRIP' DESIGN

Carbide Tipped • 2 Flute

ØD	A	B	Ød	L	Tool No.	Price
1	3/4	1/2	1/4	1-1/2	57146	\$35.56
1	3/4	1/2	1/2	2-1/8	57148	\$41.51

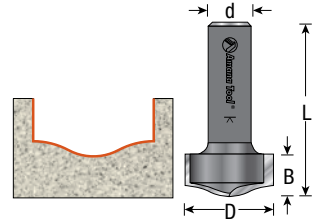

ROUND OVER

With Ultra-Glide™
Ball Bearing Guide Assembly

Carbide Tipped • 2 Flute

ØD	ØD1	a°	R	B	B1	Ød	L	Tool No.	Price
1-7/8	3/4	10°	3/8	1	25/32	1/2	2-29/32	57170	\$128.49

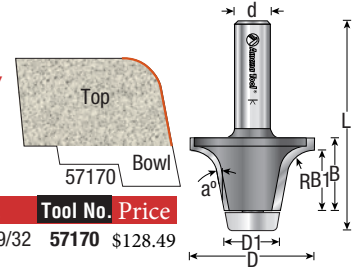

CORNER ROUNDING

With Ultra-Glide™ Radius Bearing

Carbide Tipped • 2 Flute

ØD	ØD1	A	R	B	Ød	L	Repl. Bearing	Tool No.	Price
1-3/8	3/8	3/4	3/8	5/8	1/2	2-5/8	47766	57191	\$87.85
1-5/8	5/8	1	1/2	3/4	1/2	2-3/4	47767	57190	\$94.47
2-1/8	5/8	1-1/2	3/4	1	1/2	3	47768	57192	\$103.95
2-5/8	5/8	2	1	1-1/4	1/2	3-3/16	47769	57194	\$133.63

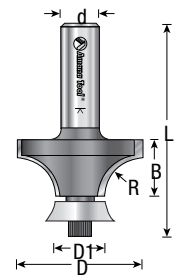
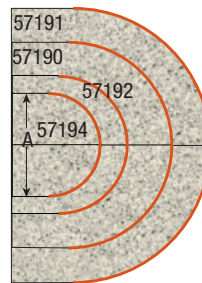

CORNER ROUNDING

With Ultra-Glide™
Ball Bearing Guide Assembly

Carbide Tipped • 2 Flute

ØD	A	R	B	Ød	L	Tool No.	Price
1-1/8	3/4	5/16	1/2	1/4	1-7/8	57150	\$38.29
1-1/8	3/4	5/16	1/2	1/2	2-1/4	57152	\$38.29
3/4	—	1/8	3/8	1/2	2-5/16	57147	\$35.56
1	—	1/4	1/2	1/2	2-7/16	57149	\$35.56
1-1/2	—	1/2	3/4	1/2	2-3/8	57139	\$43.75
2	—	3/4	1	1/2	2-3/8	57141	\$59.92

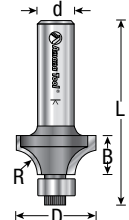
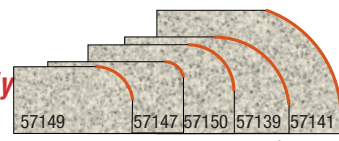

3D renderings & tool illustrations not shown at actual size.

**AMANA
ROUND UNDER**
With Upper Ball Bearing
Carbide Tipped • 2 Flute

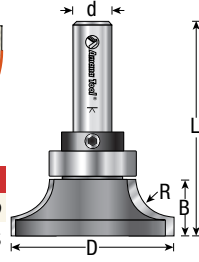
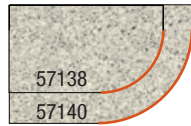

ØD	A	R	B	Ød	L	Tool No.	Price
2-1/8	1	1/2	3/4	1/2	2-7/8	57138	\$124.29
2-5/8	1-1/2	3/4	1	1/2	3	57140	\$133.25

COUNTER-TOP TRIM
Carbide Tipped • 6-Wing

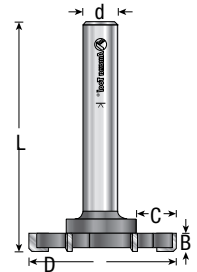

ØD	B	C	Ød	L	Tool No.	Price
2-1/16	1/4	1/2	1/2	3-5/16	57136	\$73.33

BOWL & SINK TRIM
With Ultra Glide™ Ball Bearing Guide
Carbide Tipped • 2 Flute

ØD	B	a°	Ød	L	Description	Tool No.	Price
3/4	1	10°	1/2	3-1/4	1/16 Over-Hang	57153	\$36.37
49/64	1-1/2	5°	1/2	3-1/2	1/8 Over-Hang	57155	\$48.20
3/4	1	0°	1/2	3-1/2	Flush Trim	57154	\$36.37

Replacement Ultra-Glide™
Bearing Assemblies:
(Includes #5003 5/32" hex key).

Bearing Assembly	Tool No.
47726	57153
47709	57154
47733	57155

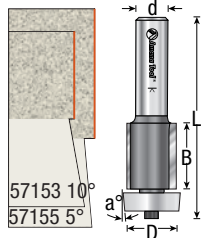

COVE/BACKSPLASH
With Upper Ultra-Glide™ Ball Bearing Guide Assembly
Carbide Tipped • 2 Flute

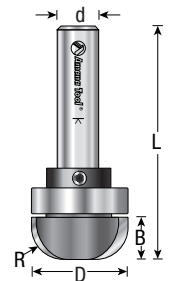
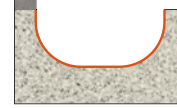

ØD	R	B	Ød	L	Tool No.	Price
1-1/8	1/2	3/8	1/2	2-7/8	57232	\$52.99

ROMAN OGEE
With Ultra-Glide™ Ball Bearing Guide Assembly
Carbide Tipped • 2 Flute

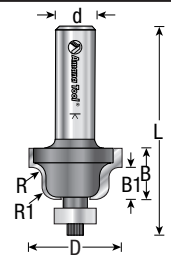
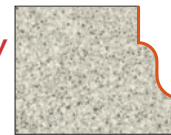

ØD	R	R1	B	B1	Ød	L	Tool No.	Price
1-1/8	1/8	5/32	5/8	3/8	1/2	2-1/2	57127	\$51.45

FLUSH TRIM
With Ball Bearing Guide
Carbide Tipped • 4 Flute

ØD	B	Ød	L	Tool No.	Price
3/4	1	1/2	3	57184	\$48.37
3/4	1-1/2	1/2	4	57185	\$47.81
3/4	2	1/2	4-1/2	57186	\$60.76
3/4	2	1/2	4-3/4	57187	\$73.26

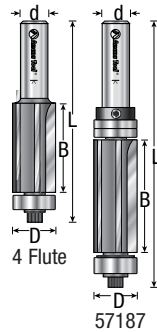

FLOORING
Carbide Tipped • 2 Flute
Rounded Dedicated Cutter With
Changeable Bearings

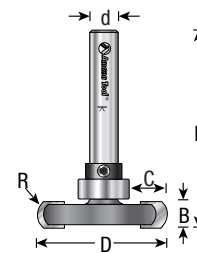

ØD	R	C	B	Ød	L	Replacement Bearing	Collar	Tool No.	Price
1-1/4	1/8	3/8	1/4	1/4	1-7/8	47701	47724	45676	\$50.47
1-1/4	1/8	5/16	1/4	1/4	1-7/8	47712	47724	45678	\$44.84

DRAINBOARD
Carbide Tipped • 2 Flute

ØD	B	R	Ød	L	Tool No.	Price
1/2	1/2	1/8	1/2	2	57114	\$15.61
5/8	1/2	1/8	1/2	2	57115	\$15.61
3/4	1/2	1/8	1/2	2	57116	\$20.41
1	1/2	1/8	1/2	2	57117	\$26.66

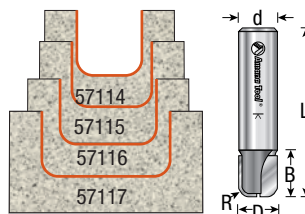

CUT-OUT BITS
Carbide Tipped • 4-Wing

ØD	B	Ød	C	L	Tool No.	Price
3	3/16	7/8 & 1	1/2	3-5/32	57165	\$101.26
3-5/8	1/4	1	1/2	3-9/32	57166	\$117.50

Bearing	Spacer	Collar	Key	Tool No.	Price
47745, 47747	55371	47739	5002	57165	\$101.26
47749	55363	47739	5002	57166	\$117.50

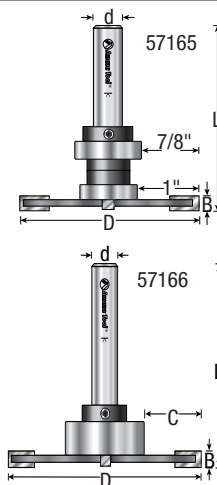
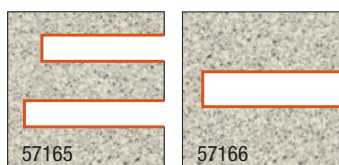

UNDERMOUNT BOWL
With Ultra-Glide™ Ball Bearing Guide Assembly
Carbide Tipped • 2 Flute

ØD	a°	R	A	B	B1	Ød	L	Type	Tool No.	Price
2-1/8	18°	1/2	1/2	1	3/4	1/2	3	Roundover	57128	\$110.85
2-1/4	18°	9/16	3/4	1-1/4	1	1/2	3-1/4	Roundover	57130	\$116.45
2-1/8	15°	1/2	1/2	1	3/4	1/2	3	Ogee	57124	\$112.25
1-1/4	11.5°	—	1/2 & 3/4	15/16	—	1/2	3	Bevel	57122	\$102.03

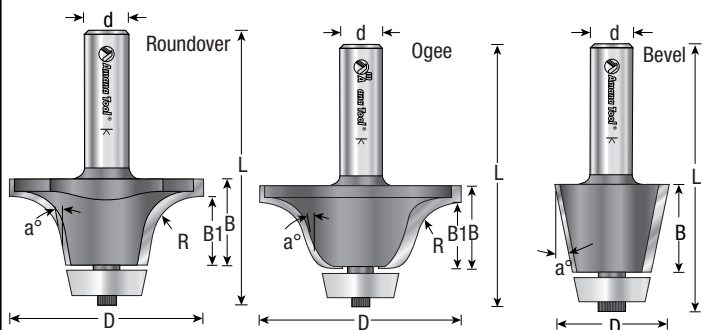

3D renderings & tool illustrations not shown at actual size.

AMANA

UNDERMOUNT BOWL

With Ultra-Glide™ Ball Bearing Guide

Carbide Tipped

2 Flute Assembly For Corian® Bowl #'s
874s, 810as, 850, 857b, 859s, 871s,
872s, 891s, 893s

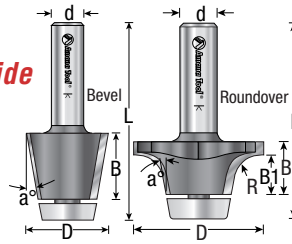

ØD	a°	R	A	B	B1	Ød	L	Type	Tool No.	Price
1-25/32	17°	3/8	1/2	11/16	17/32	1/2	2-1/2	Roundover	57156	\$120.44
2	14°	1/2	1/2	11/16	17/32	1/2	2-1/2	Roundover	57158	\$120.37
2-1/8	17°	1/2	3/4	1	25/32	1/2	2-7/8	Roundover	57160	\$100.80
2-1/4	15°	3/4	3/4	1-1/4	25/32	1/2	3	Roundover	57162	\$108.92
1-1/4	10°	—	1/2 or 3/4	1	—	1/2	3	Bevel	57168	\$101.12

KARRAN®

STAINLESS STEEL

SINK EDGE BITS

With Ultra-Glide™ Radius Ball Bearing Guide

Carbide Tipped

ØD	A	B	Ød	L	Description	Tool No.	Price
1-3/16	1/2 or 3/4	1	1/2	3-1/8	Bevel	57169	\$101.12
49/64	1/2 or 3/4	1-1/2	1/2	3-1/2	Flush	57155	\$48.20

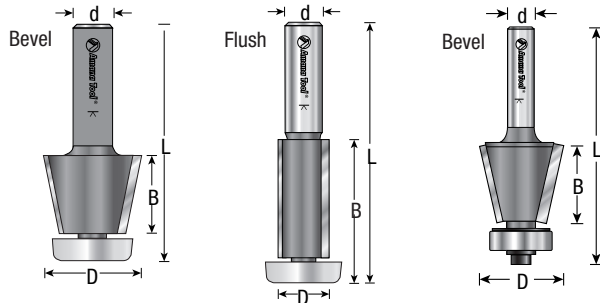

WILSONART® BOWL

With Ultra-Glide™ Ball Bearing Guide Assembly

Carbide Tipped • 2 Flute

ØD	a°	Counter-top		B	B1	Ød	L	Type	Tool No.	Price
		R	Thickness(A)							
1-1/2	12°	—	1/2 to 1-1/4	1-1/4	—	1/2	3-1/16	Bevel	57129	\$116.20
2-3/8	12°	9/16	1/2 to 3/4	7/8	11/16	1/2	2-11/16	Roundover	57161	\$121.28

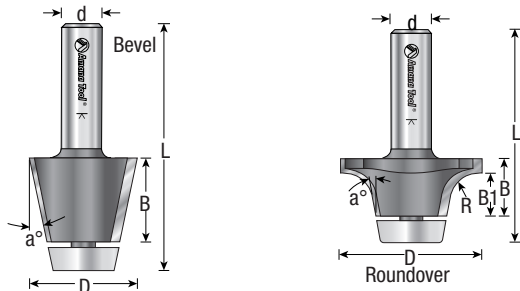

3D renderings & tool illustrations not shown at actual size.

TOPMOUNT ROUTER EUROPEAN TYPE

Carbide Tipped • 2 Flute

ØD	a°	B	Ød	L	Typ	Tool No.	Price
3/8	—	1	1/2	2-3/4	1-Flute Plunge	45302	\$14.98
29/32	15°	15/16	1/2	2-1/2	2-Flute Bevel	57132	\$59.47

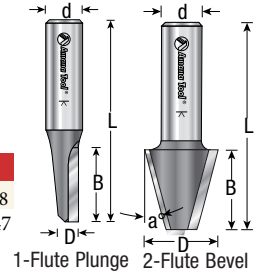

DECORATIVE EDGE

With Ultra-Glide™ Ball Bearing Guide Assembly

Carbide Tipped • 2 Flute

ØD	R	B	B1	Ød	L	Tool No.	Price			
2-5/8	5/16	1-5/8	15/16	1/2	3-1/2	57200	\$128.00			
ØD	R	B	B1	Ød	L	Tool No.	Price			
1-5/8	15/64	2	1-17/32	1/2	3-1/2	57202	\$107.73			
ØD	R	R1	B	B1	Ød	L	Tool No.	Price		
2-3/4	1/2	1/4	1-5/16	1	1/2	3-1/8	57208	\$95.48		
ØD	R	R1	R2	R3	B	B1	Ød	L	Tool No.	Price
3	3/16	1/2	1/8	3/8	1-9/16	1-5/32	1/2	3-5/16	57210	\$155.26
ØD	R	B	B1	Ød	L	Tool No.	Price			
2-3/4	1/2	1-1/4	1	1/2	3-1/4	57214	\$101.19			
ØD	R	R1	B	Ød	L	Tool No.	Price			
2-1/2	3/8	1/2	1-1/8	1/2	3-1/8	57216	\$101.19			

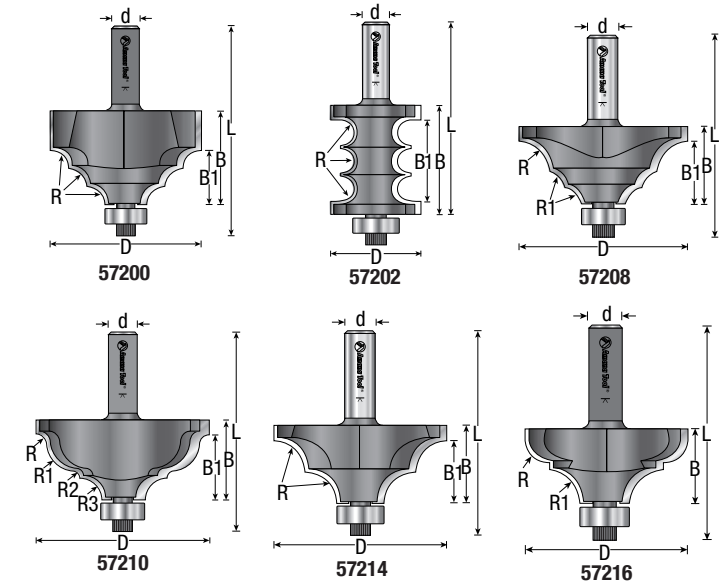

CHAMFER

With Ultra-Glide™ Ball Bearing Guide Assembly

Carbide Tipped • 2 Flute

ØD	a°	B	Ød	L	Tool No.	Price
2	45°	3/4	1/2	2-5/8	57220	\$80.78
2-17/32	30°	1-3/4	1/2	3-5/8	57258	\$129.99

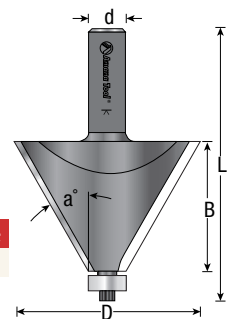

AMANA DOUBLE BULLNOSE

With Ball Bearing Guide

Carbide Tipped • 2 Flute

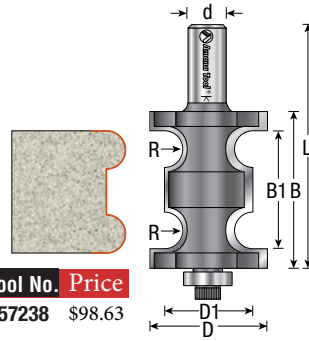

ØD	ØD1	R	B	B1	Ød	L	Tool No.	Price
1-1/2	1-1/8	15/64	2	1-1/2	1/2	3-1/8	57238	\$98.63

MULTI RADIUS

*With Ultra-Glide™
Ball Bearing Guide Assembly*

Carbide Tipped • 2 Flute

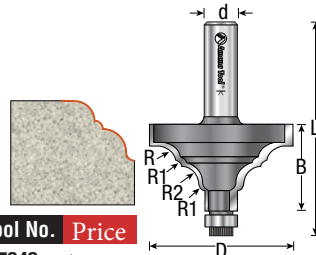

ØD	R	R1	R2	B	Ød	L	Tool No.	Price
2-1/4	15/64	3/32	9/32	1-3/8	1/2	3-1/8	57242	\$119.56

LONG Ogee

*With Ultra-Glide™
Ball Bearing Guide Assembly*

Carbide Tipped • 2 Flute

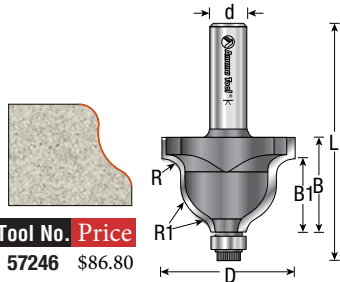

ØD	R	R1	B	B1	Ød	L	Tool No.	Price
1-3/4	15/64	33/64	1-1/4	1	1/2	3-1/4	57246	\$86.80

DECORATIVE EDGE

*With Ultra-Glide™
Ball Bearing Guide Assembly*

Carbide Tipped • 2 Flute

ØD	R	R1	B	Ød	L	Tool No.	Price	
3	5/16	1/2	1-1/8	1/2	3-1/8	57248	\$157.22	
ØD	R	R1	R2	B	Ød	L	Tool No.	Price
3	1/4	15/64	1/2	1-11/64	1/2	3-1/16	57252	\$159.36
ØD	R	R1	B	Ød	L	Tool No.	Price	
2-1/2	19/32	19/64	7/8	1/2	2-3/4	57254	\$102.27	

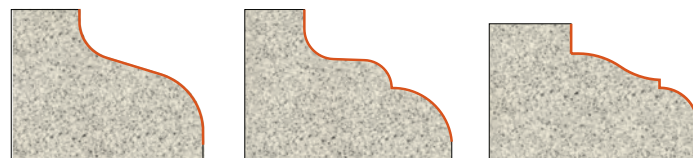
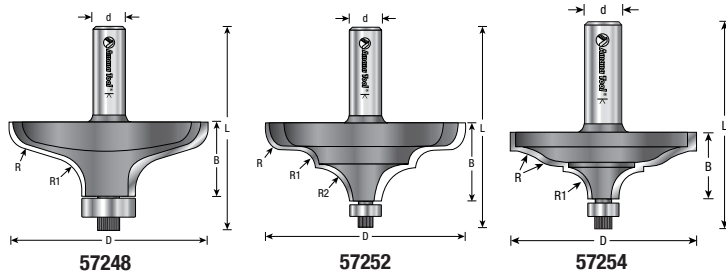

3D renderings & tool illustrations not shown at actual size.

DECORATIVE EDGE TRIM

Carbide Tipped • 2 Flute

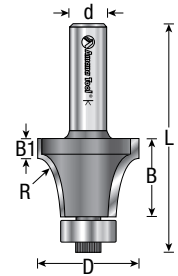
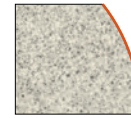

B1	ØD	B	R	Ød	L	Tool No.	Price
1-5/16	1-1/16	7/32	1-3/8	1/2	3-1/8	57257	\$87.08

WAVY JOINT

Carbide Tipped • 2 Flute

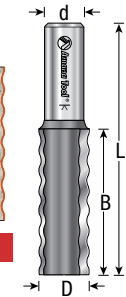

ØD	B	Ød	L	Tool No.	Price
5/8	1-13/16	1/2	3-1/8	57260	\$56.14

BACKSPLASH

Carbide Tipped • 2 Flute

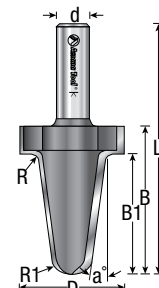
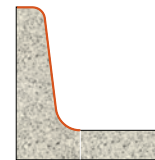

ØD	a°	R	R1	B	B1	Ød	L	Tool No.	Price
1-17/32	7°	15/64	1/8	1-9/16	1-3/16	1/2	3-1/16	57228	\$91.39
1-17/32	7°	15/64	1/8	2-1/8	1-3/4	1/2	3-11/16	57230	\$96.26

ULTRA-GLIDE™ HIGH-PERFORMANCE BALL BEARING GUIDE ASSEMBLIES

Application	Ød	ØD	a°/R	Tool No.	Price
1/2" Diameter Flush Trim, Corner Rounds All Tools That Accept Our Regular #47706 Steel Bearing	3/16	.500	-0- (1/2)	47707	\$8.02
47140, 57154 Trim Bits And New Style 57118, 57120, 57257	1/4	.750 (3/4)	-0-	47709*	\$14.49
Slot Cutter Assemblies: 1/4" Depth Of Cut, 53610	5/16	1.382 (1-3/8)	-0-	47727	\$9.03
Slot Cutter Assemblies: 3/8" Depth Of Cut, 53610	5/16	1.137 (1-9/64)	-0-	47728	\$9.31
Set Of Two Above: 47727 & 47728	5/16		-0-	47729	\$17.08
Old Style 57122 Bevel Bit With 31/32" Large Diameter	1/4	.965 (31/32)	10°	47725*	\$17.99
New Style 57122, Other 'Solid-Surface' Type Bits	1/4	.866 (7/8)	10°	47726*	\$17.99
57156 Through 57168 Bowl Bits Only	1/4	.866 (7/8)	10°	47731*	\$17.99
57129 And 57161	1/4	1	12°	47732*	\$10.78
New Bowl Bits	1/4	1	5°	47733*	\$14.11
57138, 57140	15mm (1-1/8)	1.125	-0-	47737	\$19.67
57192	1/4	3/4	3/4	47768	\$19.36
57194	1/4	3/4	1	47769	\$19.36

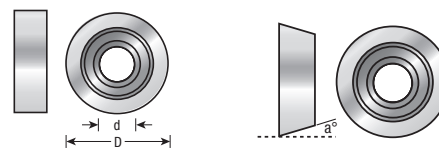

AMANA SAW BLADES

Industrial quality carbide-tipped saw blades compatible with Festool® Machines.

Tool #	Diameter	Teeth Grind	Kerf Inch	Plate Inch	Hook Angle	Bore	Application	Festool® Machines	Price
MD160-120	160mm	12 ATB	.100	.063	22°	20mm	Wood, Building panels, Soft plastics	TS 55 EQ ATF 55E AP 55	\$26.26
MD160-140	160mm	14 ATB	.100	.063	28°	20mm	Rip Blade	TS 55 EQ	\$27.68
MD160-280	160mm	28 ATB	.100	.063	15°	20mm	General Purpose	TS 55 EQ ATF 55 E AP 55	\$33.60
MD160-480	160mm	48 ATB	.087	.063	5°	20mm	Crosscut	TS 55 EQ	\$37.09
MD160-488	160mm	48 M-TCG	.102	.071	-2°	20mm	Solid Surface	TS 55 EQ ATF 55 E	\$48.23
MD160-565	160mm	56 TCG	.100	.071	-5°	20mm	Aluminum/Plastic	TS 55 EQ	\$65.12
MD210-160	210mm	16 ATB	.102	.071	28°	30mm	Rip Blade	TS 55 EQ	\$35.60
MD210-182	210mm	18 ATB	.102	.071	20°	30mm	Wood, Building panel, Soft plastics	TS 55 EQ	\$33.97
MD210-360	210mm	36 ATB	.094	.071	15°	30mm	General Purpose	TS 55 EQ ATF 55 E AP 55	\$42.36
MD210-523	210mm	52	.094	.071	5°	30mm	Fine Crosscut in sheet goods, Melamine	TS 55EQ ATF 55 E	\$65.49
MD210-608	210mm	60	.094	.071	-2°	30mm	Solid Surface/Laminate	TS 55 EQ ATF 55 E	\$68.29
MD210-725	210mm	72	.094	.071	-5°	30mm	Aluminum/Plastic	TS 55 EQ	\$76.33

AMANA PRESTIGE™

10" to 12"

18° Hook Alternate Top Bevel (ATB) Grind

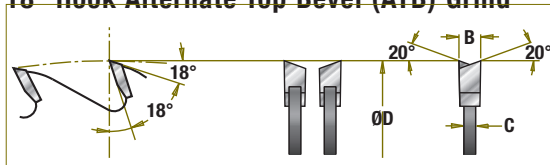

The Amana Tool® Prestige™ general-purpose blade cuts smoother and stays sharper, longer – in both solid wood and man-made materials. It features a massive tool-steel plate (.102" thick!) with expansion slots and copper plugs that practically eliminate vibration. The 40 teeth are ground with a steep 20° bevel angle, alternating left and right, for crisp, clean cuts both across grain and with the grain. The 18° hook angle yields an effortless feed. The precision-ground D-10 carbide teeth are individually computer-verified to have minimal runout.

- Massive (.102" thick!) tool-steel plate with copper plugs that practically eliminates vibration.
- Precision-ground D-10 carbide teeth (20° ATB, hook) are individually computer verified for runout of less than 1/10,000" on all axis.

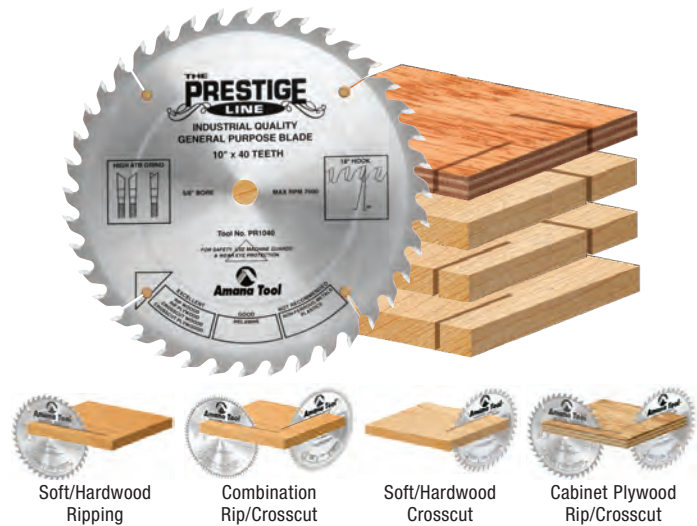

Prestige™ Rated "EXCELLENT" for

- ✓ Ripping solid wood
- ✓ Crosscutting solid wood
- ✓ Ripping plywood
- ✓ Crosscutting plywood

ØD		Teeth	Grind	'B' Kerf Inch	'C' Plate Inch	Bore	Tool No.	Price
Inch	mm							
10	250	40	ATB	.134	.102	5/8	PR1040	\$75.67
12	300	40	ATB	.134	.102	1	PR1240	\$105.77

'EURO-RIP' RIPPING

With Cooling Slots And Anti-Kickback Feature

10" to 16"

20° Hook • Flat Top (FT) Grind

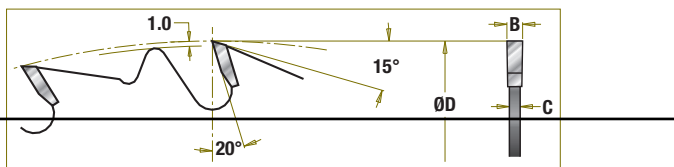

Designed for ripping hardwood and softwood, this exceptional blade cuts fast and smooth. The flat-top grind and the high positive hook angle reduce feed effort. The anti-kickback limits the thickness of chip; taken to offer a safer cut. Cooling slots in the body prevent excessive heat build-up.

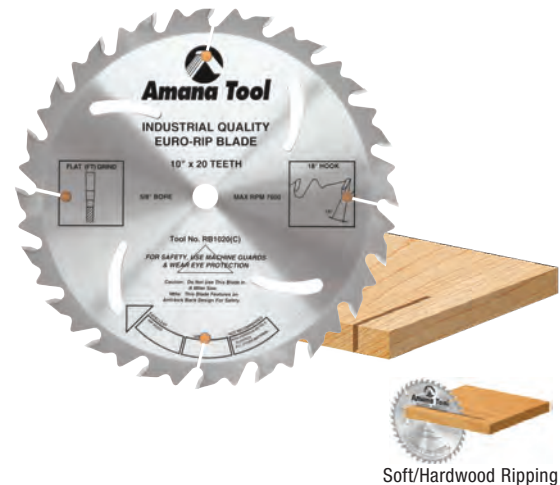

Soft/Hardwood Ripping

ØD		Teeth	Grind	'B' Kerf Inch	'C' Plate Inch	Bore	*P.H	Tool	Price
Inch	mm								
10	250	20	FT	.126	.087	5/8	—	RB1020	\$72.52
10	250	20	FT	.126	.087	30mm	2/7/42 & 2/10/60	RB1020-3	\$72.52
12	300	24	FT	.126	.087	1	—	RB1224	\$92.12
12	300	24	FT	.126	.087	30mm	2/7/42 & 2/10/60	RB1224-3	\$88.55
14	350	28	FT	.126	.087	1	—	RB1428	\$110.57
14	350	28	FT	.126	.087	30mm	2/7/42 & 2/10/60	RB1428-3	\$110.57
16	400	28	FT	.137	.098	1	—	RB1628	\$125.51

Note: All 30mm bore include the pin-hole arrangements.

**AMANA
RIPPING STANDARD**

10" to 20"
Flat Top (FT) Grind

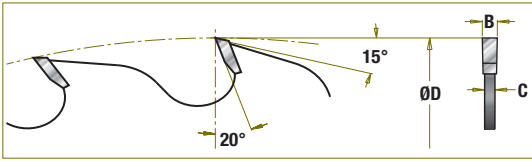

20° Hook

ØD		Teeth	Grind	'B' Kerf Inch	'C' Plate Inch	Bore	*P.H.	Tool No.	Price
Inch	mm								
10	250	24	FT	.142	.095	5/8	—	610240	\$84.04
12	300	30	FT	.160	.110	1	—	612300	\$106.33
12	300	30	FT	.173	.110	30mm	2/7/42 & 2/10/60	612300-30	\$108.43
16	400	36	FT	.173	.118	30mm	2/7/42 & 2/10/60	616360-30	\$136.64
18	450	32	FT	.157	.110	1	—	618320	\$136.85
20	500	36	FT	.173	.110	1	—	620360	\$170.87

18° Hook

ØD		Teeth	Grind	'B' Kerf Inch	'C' Plate Inch	Bore	*P.H.	Tool No.	Price
Inch	mm								
10	250	20	FT	.126	.087	5/8	—	610200	\$68.60
12	300	24	FT	.126	.087	1	—	612240	\$82.25
12	300	24	FT	.126	.087	30mm	2/7/42 & 2/10/60	612240-30	\$82.25
14	350	28	FT	.137	.098	1	—	614280	\$97.23
16	400	32	FT	.137	.098	1	—	616320	\$110.67
16	400	32	FT	.137	.098	30mm	2/7/42 & 2/10/60	616320-30	\$110.67

*P.H. denotes pin-hole configuration, if applicable. Example: 2/10/60 = 2 @ 10mm dia. on 60mm circle.

**AMANA
RIPPING HEAVY-DUTY**

10" to 16"
18° Hook • Flat Top (FT) Grind

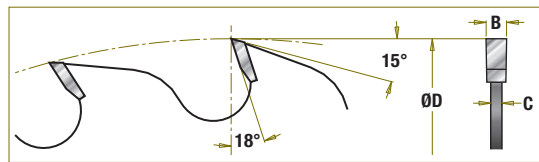

ØD		Teeth	Grind	'B' Kerf Inch	'C' Plate Inch	Bore	*P.H.	Tool No.	Price
Inch	mm								
10	250	20	FT	.150	.095	5/8	—	710200	\$84.11
12	300	24	FT	.173	.110	1	—	712240	\$101.57
14	350	28	FT	.173	.110	1	—	714280	\$120.12
14	350	28	FT	.173	.110	30mm	2/7/42 & 2/10/60	714280-30	\$120.12
16	400	32	FT	.173	.118	1	—	716320	\$138.08
16	400	32	FT	.173	.118	30mm	2/7/42 & 2/10/60	716320-30	\$138.08

GLUE LINE RIPPING

10" to 14"

22° Hook • Triple chip (TC) Grind

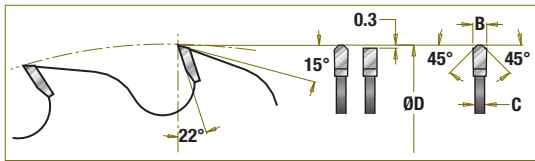

ØD		Teeth	Grind	'B' Kerf Inch	'C' Plate Inch	Bore	Machine	Tool No.	Price
Inch	mm								
10	250	30	TCG	.145	.095	5/8	—	610301	\$89.36
12	300	40	TCG	.160	.110	1	—	612401	\$114.66
14	350	40	TCG	.169	.118	1	—	614401	\$135.21
14	350	40	TCG	.169	.118	3-1/8	Mereen-Johnson	614401-3-1/8	\$135.21
14	350	40	TCG	.169	.118	70mm	SCM	614401-70 △	\$135.21

△ 2 Keyways (20mm Centers x 5mm Dia.)

* P.H. denotes pin-hole configuration, if applicable. Example: 2/10/60 = 2 @ 10mm dia. on 60mm circle.

AMANA MULTI-USE RIPPING/GENERAL PURPOSE

10" to 20"

20° Hook • Alternate Top Bevel (ATB) Grind

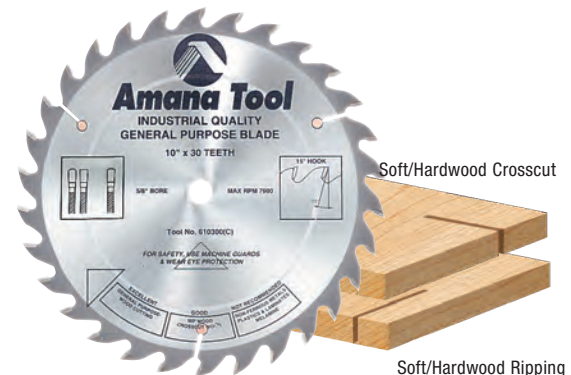
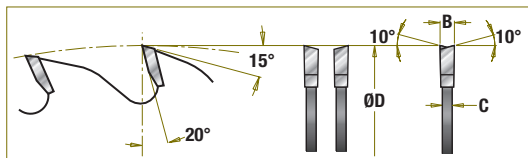

ØD		Teeth	Grind	'B' Kerf Inch	'C' Plate Inch	Bore	*P.H	Tool No.	Price
Inch	mm								
10	250	30	ATB	.126	.087	5/8	—	610300	\$78.79
10	250	30	ATB	.126	.087	30mm	2/7/42 & 2/10/60	610300-30	\$78.79
12	300	36	ATB	.126	.087	1	—	612360	\$91.74
12	300	36	ATB	.126	.087	30mm	2/7/42 & 2/10/60	612360-30	\$91.74
14	350	42	ATB	.137	.098	1	—	614420	\$110.95
14	350	42	ATB	.137	.098	30mm	2/7/42 & 2/10/60	614420-30	\$110.95
16	400	48	ATB	.137	.098	1	—	616480	\$134.61
16	400	48	ATB	.137	.098	30mm	2/7/42 & 2/10/60	616480-30	\$134.61
18	450	54	ATB	.150	.110	1	—	618540	\$178.29
20	500	60	ATB	.173	.110	1	—	620600	\$207.69

GENERAL PURPOSE CUT-OFF

200mm to 16"

15° Hook • Alternate Top Bevel (ATB) Grind

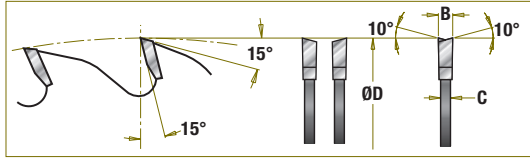

ØD		Teet	Grind	'B' Kerf	'C' Plate	Bore	* P.H.	Tool No.	Price
Inch	mm								
8	200	34	ATB	.118	.079	5/8	—	683400	\$67.24
—	220	34	ATB	.118	.079	30mm	2/7/42	220T340 †	\$90.09
9	230	24	ATB	.118	.079	5/8	—	692400	\$57.30
9	230	40	ATB	.118	.079	5/8	—	694000	\$80.71
12	300	48	ATB	.126	.087	1	—	612480	\$100.98
12	300	48	ATB	.126	.087	30mm	2/7/42 & 2/10/60	612480-30	\$100.98
14	350	54	ATB	.137	.098	1	—	614540	\$124.01
14	350	54	ATB	.137	.098	30mm	2/7/42 & 2/10/60	614540-30	\$124.01
16	400	60	ATB	.137	.098	1	—	616600	\$141.86
16	400	60	ATB	.137	.098	30mm	2/7/42 & 2/10/60	616600-30	\$141.86

† For Holz-Her® 220mm panel saws. * P.H. denotes pin-hole configuration, if applicable. Example: **2/10/60** = 2 @ 10mm dia. on 60mm circle.

AMANA THIN KERF GENERAL PURPOSE

8" to 15"

15° Hook • Alternate Top Bevel (ATB) Grind

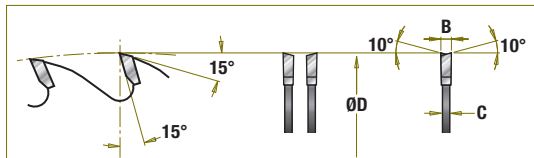

ØD		Teeth	Grind	'B' Kerf	'C' Plate	Bore	Tool No.	Price
Inch	mm							
8	200	34	ATB	.090	.062	5/8	TB83400	\$68.15
10	250	40	ATB	.090	.062	5/8	TB10400	\$75.85
12	300	48	ATB	.090	.062	1	TB12480	\$98.60
14	350	54	ATB	.090	.062	1	TB14540	\$122.61
15	375	48	ATB	.104	.079	1	615480	\$145.11

COMBINATION RIPPING & CROSSCUT

8" to 16"

15° Hook • Combination Grind 4 ATB & 1 Raker

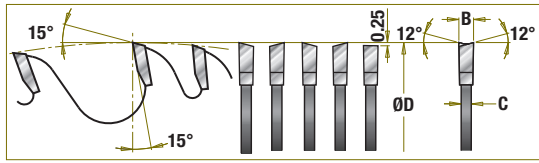

ØD		Teeth	Grind	'B' Kerf Inch	'C' Plate Inch	Bore	Tool No.	Price
Inch	mm							
8	200	40	4 & 1	.126	.087	5/8	684004	\$77.11
9	230	40	4 & 1	.126	.087	5/8	694004	\$82.57
10	250	50	4 & 1	.135	.095	5/8	610504	\$74.90
12	300	60	4 & 1	.150	.110	1	612604	\$126.63
14	350	70	4 & 1	.150	.110	1	614704	\$168.32
16	400	80	4 & 1	.158	.118	1	616804	\$229.01

AMANA GENERAL PURPOSE CUT-OFF

8" to 20"

10° Hook • Triple Chip (TC) Grind

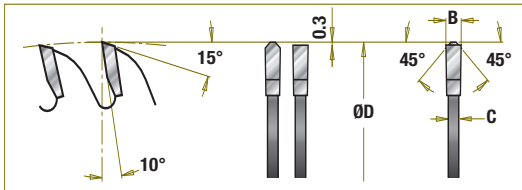

ØD		Teeth	Grind	'B' Kerf Inch	'C' Plate Inch	Bore	*P.H	Tool No.	Price
Inch	mm								
8	200	48	TCG	.118	.079	5/8	—	684801	\$86.84
9	230	40	TCG	.118	.079	5/8	—	694001	\$88.17
10	250	60	TCG	.126	.087	5/8	—	610601	\$73.57
10	250	60	TCG	.126	.087	30mm	2/7/42 & 2/10/60	610601-30	\$73.57
12	300	60	TCG	.126	.087	1	—	612601	\$124.67
12	300	60	TCG	.126	.087	30mm	2/7/42 & 2/10/60	612601-30	\$124.67
12	300	72	TCG	.126	.087	1	—	612721	\$138.71
12	300	72	TCG	.126	.087	30mm	2/7/42 & 2/10/60	612721-30 †	\$138.71
14	350	54	TCG	.137	.106	1	—	614541	\$125.55
14	350	72	TCG	.137	.098	1	—	614721	\$151.55
14	350	72	TCG	.137	.098	30mm	2/7/42 & 2/10/60	614721-30	\$151.55
14	350	84	TCG	.137	.098	1	—	614841	\$170.59
16	400	96	TCG	.137	.098	1	—	616961	\$202.41
18	450	108	TCG	.158	.110	1	—	618109	\$257.15
18	450	108	TCG	.158	.110	30mm	2/7/42 & 2/10/60	618109-30	\$257.15
20	500	120	TCG	.173	.110	1	—	620121	\$311.12

• 15° Hook Angle (Tool # 694001 Only)

† For Altendorf®, Omega, SCMI®, and Striebig® sliding table saws.

AMANA

CUT-OFF & CROSSCUT

8" to 20"

10° Hook • Alternate Top Bevel (ATB) Grind

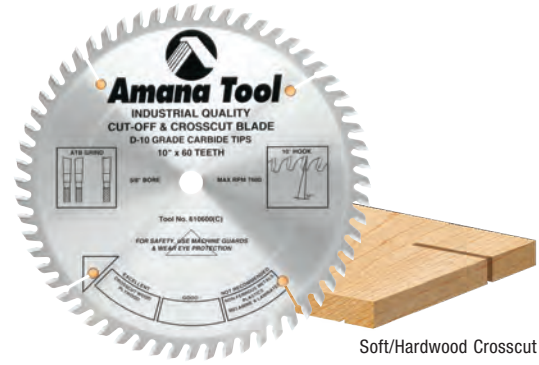
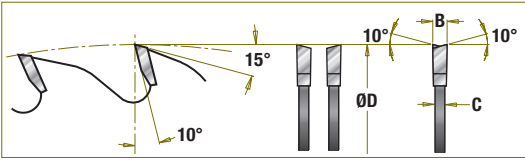

Soft/Hardwood Crosscut

ØD		Teeth	Grind	'B' Kerf	'C' Plate	Bore	*P.H.	Tool No.	Price
Inch	mm								
8	200	48	ATB	.118	.079	5/8	—	684800	\$82.74
9	230	60	ATB	.118	.079	5/8	—	696000	\$94.92
10	250	60	ATB	.126	.087	5/8	—	610600	\$68.46
10	250	60	ATB	.126	.087	30mm	2/7/42 & 2/10/60	610600-30	\$72.49
12	300	60	ATB	.126	.087	1	—	612600	\$115.33
12	300	60	ATB	.126	.087	30mm	2/7/42 & 2/10/60	612600-30	\$115.33
12	300	72	ATB	.126	.087	1	—	612720	\$129.54
12	300	72	ATB	.126	.087	30mm	2/7/42 & 2/10/60	612720-30 †	\$129.54
14	350	72	ATB	.137	.098	1	—	614720	\$141.44
14	350	72	ATB	.137	.098	30mm	2/7/42 & 2/10/60	614720-30	\$141.44
14	350	84	ATB	.137	.098	1	—	614840	\$161.00
16	400	96	ATB	.137	.098	1	—	616960	\$187.15
18	450	108	ATB	.158	.110	1	—	618108	\$235.48
18	450	108	ATB	.158	.110	30mm	2/7/42 & 2/10/60	618108-30	\$235.48
20	500	120	ATB	.173	.110	1	—	620120	\$296.63

† For Altendorf®, Omega, SCMI®, and Striebig® sliding table saws.

CUT-OFF & CROSSCUT HEAVY-DUTY

12" to 16"

10° to 18° Hook • Alternate Top Bevel (ATB) Grind

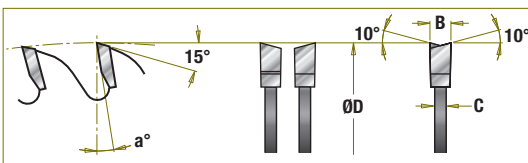

Soft/Hardwood Crosscut

ØD		Teeth	Grind	a°	'B' Kerf	'C' Plate	Bore	Tool No.	Price
Inch	mm								
12	300	96	ATB	10°	.173	.110	1	712960	\$177.31
14	350	54	ATB	15°	.173	.110	1	714540	\$145.04
16	400	60	ATB	18°	.173	.110	1	716600	\$163.52
16	400	80	ATB	10°	.173	.110	1	716800	\$213.64
16	400	96	ATB	10°	.173	.110	1	716960	\$241.47

AMANA CUT-OFF & CROSSCUT HEAVY-DUTY

12" to 16"

10° to 18° Hook • Triple Chip (TC) Grind

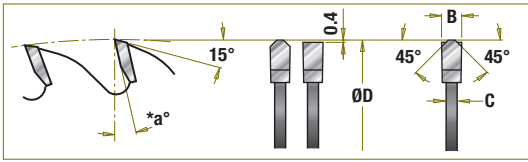

ØD		Teeth	Grind	a°	'B' Kerf	'C' Plate	Bore	Tool No.	Price
Inch	mm								
12	300	60	TCG	15°	.173	.095	1	712601	\$145.36
12	300	96	TCG	10°	.173	.098	1	712961	\$180.08
14	350	54	TCG	15°	.173	.110	1	714541	\$145.04
14	350	72	TCG	15°	.173	.110	1	714721	\$180.46
14	350	84	TCG	10°	.173	.110	1	714841	\$196.14
16	400	80	TCG	10°	.173	.118	1	716801	\$213.57
16	400	96	TCG	18°	.173	.118	1	716961	\$234.36

FINE CUT-OFF & CROSSCUT

8" to 18"

10° Hook • Triple Chip (TC) Grind

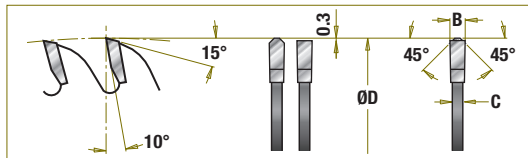

ØD		Teeth	Grind	'B' Kerf	'C' Plate	Bore	*P.H	Tool No.	Price
Inch	mm								
8	200	64	TCG	.118	.079	5/8	—	686401	\$99.12
8	200	64	TCG	.118	.079	30mm	—	686401-30	\$99.12
—	220	64	TCG	.118	.079	30mm	2/7/42	220T641 †	\$110.46
10	250	80	TCG	.126	.087	5/8	—	610801	\$115.89
10	250	80	TCG	.126	.087	30mm	2/7/42 & 2/10/60	610801-30	\$116.62
12	300	96	TCG	.126	.087	1	—	612961	\$151.13
12	300	96	TCG	.126	.087	30mm	2/7/42 & 2/10/60	612961-30	\$151.13
14	350	108	TCG	.137	.098	1	—	614109	\$178.22
14	350	108	TCG	.137	.098	30mm	2/7/42 & 2/10/60	614109-30	\$178.22
16	400	120	TCG	.137	.098	1	—	616129	\$215.95
18	450	132	TCG	.157	.110	1	—	618133	\$286.97

† For Holz-Her® 220mm Panel Saws.

AMANA

TRIM

7" to 18"

10° Hook • Alternate Top Bevel (ATB) Grind

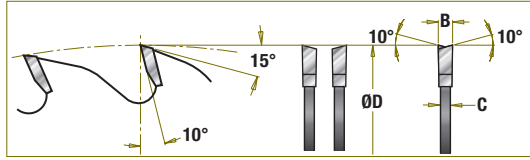

ØD		Teeth	Grind	'B' Kerf Inch	'C' Plate Inch	Bore	*P.H	Tool No.	Price
Inch	mm								
7	180	58	ATB	.118	.079	5/8	—	675600	\$84.84
8	200	64	ATB	.118	.079	5/8	—	686400	\$93.09
—	220	64	ATB	.118	.079	30mm	2/7/42	220T640 +	\$105.07
10	250	80	ATB	.126	.087	5/8	—	610800	\$110.50
10	250	80	ATB	.126	.087	30mm	2/7/42 & 2/10/60	610800-30	\$110.50
12	300	96	ATB	.126	.087	1	—	612960	\$144.97
12	300	96	ATB	.126	.087	30mm	2/7/42 & 2/10/60	612960-30	\$144.97
14	350	108	ATB	.137	.098	1	—	614108	\$174.13
14	350	108	ATB	.137	.098	30mm	2/7/42 & 2/10/60	614108-30	\$174.13
16	400	120	ATB	.137	.098	1	—	616128	\$214.90
18	450	132	ATB	.157	.110	1	—	618132	\$277.41

+ For Holz-Her® 220mm Panel Saws.

THIN KERF TRIM

8" to 14"

10° Hook • Alternate Top Bevel (ATB) or Triple Chip (TC) Grind

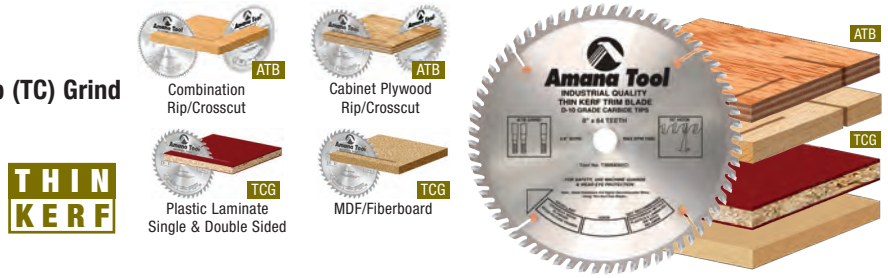
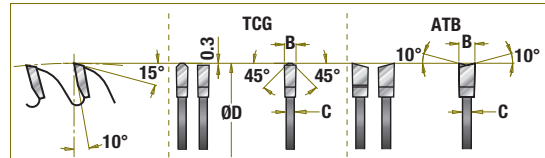

ØD		Teeth	Grind	'B' Kerf Inch	'C' Plate Inch	Bore	Tool No.	Price
Inch	mm							
8	200	64	ATB	.090	.062	5/8	TB86400	\$94.57
10	250	80	ATB	.090	.062	5/8	TB10800	\$121.00
10	250	100	ATB	.090	.062	5/8	TB10100	\$155.51
12	300	96	ATB	.090	.062	1	TB12960	\$144.97
14	350	108	ATB	.090	.062	1	TB14108	\$168.91
8	200	64	TCG	.090	.062	5/8	TB86401	\$102.17
10	250	80	TCG	.090	.062	5/8	TB10801	\$129.50
10	250	100	TCG	.090	.062	5/8	TB10101	\$163.35
12	300	96	TCG	.090	.062	1	TB12961	\$156.59
14	350	108	TCG	.090	.062	1	TB14109	\$181.65

AMANA THIN KERF MITER

10" to 15"
10° Hook • Alternate Top Bevel (ATB) Grind

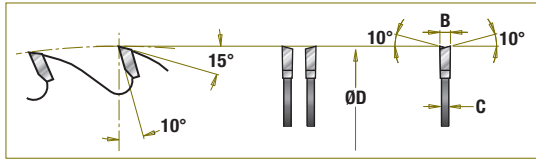

ØD		Teeth	Grind	'B' Kerf		'C' Plate		Bore	Tool No.	Price
Inch	mm			Inch	Inch	Inch	Inch			
10	250	80	ATB	.090	.062	5/8		610800-TS	\$116.06	
12	300	96	ATB	.090	.062	1		612960-TS	\$138.08	
14	350	108	ATB	.090	.062	1		614108-TS	\$165.87	
15	375	100	ATB	.104	.079	1		615100-TS	\$186.48	

THIN KERF MITER

10"
10° Hook • Triple Chip (TC) Grind

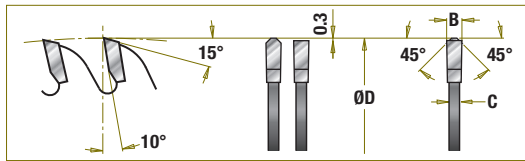

ØD		Teeth	Grind	'B' Kerf		'C' Plate		Bore	Tool No.	Price
Inch	mm			Inch	Inch	Inch	Inch			
10	250	80	TCG	.090	.062	5/8		610801-TS	\$122.96	

GROOVERS

8" to 10"
Flat Top (FT) Grind • 12° Hook Angle

ØD		Teeth	'B' Kerf		'C' Plate		Max RPM	Bore	Tool No.	Price
Inches	mm		Inches	mm	Inches	mm				
8	200	24	.250	6.35	.180	4.57	9,000	5/8	61365	\$165.16
10	250	24	.250	6.35	.180	4.57	7,600	5/8	61368	\$188.91

PLYWOOD & PLASTIC CUTTING

7-1/4"
Triple Chip (TC) Grind • Positive Hook

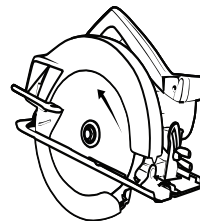
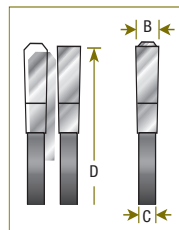

Acrylic & Non-Melt Plastic

ØD	Teeth	'B' Kerf	'C' Plate	Bore	Tool No.	Price
7-1/4	40	.120	.078	*5/8 Universal	PC-620	\$34.37

AMANA

MITER/DOUBLE MITER

10" to 15"

2° Negative Hook • 4 ATB & 1 Raker

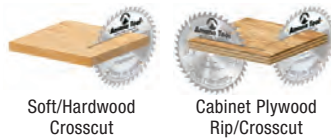
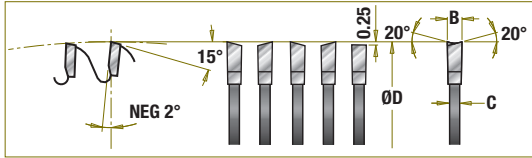

*ØD Inch	Teeth	Grind	'B' Kerf Inch	'C' Plate Inch	Bore	Machine Type	Tool No.	Price
10	60	4&1	.115	.087	5/8	All Types	MS10600	\$132.62
12	100	4&1	.134	.110	5/8	Pistorius, CTD	MS12100-5/8	\$194.32
12	80	4&1	.122	.110	5/8	Pistorius, CTD	MS12800-5/8	\$179.97
12	80	4&1	.122	.110	1	Dewalt, Hitachi	MS12800	\$179.97
14	100	4&1	.150	.118	5/8	Pistorius, CTD	MS14100-5/8	\$205.49
14	100	4&1	.150	.118	1	Makita	MS14100	\$203.70
15	100	4&1	.118	.098	1	Hitachi	MS15100	\$212.17

True "Imperial" Sizes.

MITER/DOUBLE MITER

10" to 12"

5° Negative Hook • California Triple Chip (C-TC) Grind

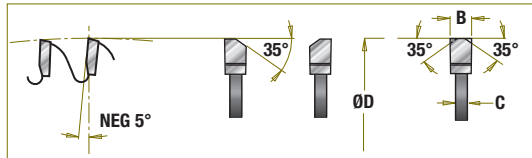

*ØD Inch	Teeth	Grind	'B' Kerf Inch	'C' Plate Inch	Bore	Machine Type	Tool No.	Price
10	96	C-TCG	.125	.100	5/8	Pistorius, CTD	CTC10963	\$194.32
12	90	C-TCG	.135	.110	5/8	Pistorius, CTD	CTC12903-5/8	\$194.32
12	108	C-TCG	.135	.110	1	Pistorius, CTD	CTC12108	\$233.73

* True "Imperial" Sizes.

GENERAL PURPOSE

4-3/8" & 5-1/2"

Alternate Top Bevel (ATB) Grind • Positive Hook

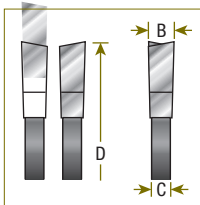

ØD	Teeth	'B' Kerf	'C' Plate	Bore	Tool No.	Price
5-1/2	30	.072	.052	5/8 ***	RM-550	\$27.20

***RM-550 fits Makita 5-1/2" saw and others.

Comes with two adapter bushings, one for 5/8" arbor and one for 10mm arbor.
Replacement bushing for RM-550: #BU-110 (5/8 x 1/2), #BU-125 (5/8 x 10mm).

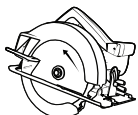

AMANA DOUBLE-FACE MELAMINE & LAMINATE

8" to 16"

6° Negative Hook • 25° 'High-ATB' Grind

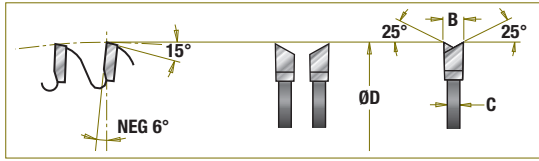

ØD		Teeth	Grind	'B' Kerf	'C' Plate	Bore	*P.H.	Tool No.	Price
Inch	mm								
8	200	64	H-ATB	.110	.087	5/8	—	MB86400	\$122.36
—	220	42	H-ATB	.110	.087	30mm	2/7/42	MB220T420†	\$109.69
10	250	80	H-ATB	.126	.102	5/8	—	MB10800	\$112.95
10	250	80	H-ATB	.126	.102	30mm	2/7/42 & 2/10/60	MB10800-30	\$112.95
12	300	96	H-ATB	.126	.102	1	—	MB12960	\$153.51
12	300	96	H-ATB	.126	.102	30mm	2/7/42 & 2/10/60	MB12960-30	\$153.51
14	350	108	H-ATB	.126	.102	1	—	MB14108	\$188.37
14	350	108	H-ATB	.126	.102	30mm	2/7/42 & 2/10/60	MB14108-30	\$188.37
16	400	120	H-ATB	.150	.126	1	—	MB16120	\$234.85

Note: The 8" blade can be used on vertical type panel saws, such as 'Safety Speed Cut', etc.

† For 220mm Holz-Her® Panel Saws.

DOUBLE-FACE MELAMINE, KORTON & VENEERS

10" to 12"

2° Negative Hook • 35° 'High-ATB' Grind

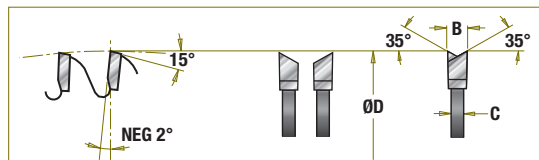

ØD		Teeth	Grind	'B' Kerf	'C' Plate	Bore	*P.H.	Tool No.	Price
Inch	mm								
10	250	80	H-ATB	.118	.087	5/8	—	MSB1080	\$125.83
10	250	80	H-ATB	.118	.087	30mm	2/7/42 & 2/10/60	MSB1080-30	\$125.83
12	300	96	H-ATB	.118	.087	1	—	MSB1296	\$153.51
12	300	96	H-ATB	.118	.087	30mm	2/7/42 & 2/10/60	MSB1296-30	\$153.51

AMANA

SOLID SURFACE

10" to 16"

0° Hook • Modified Triple Chip (MTC) Grind

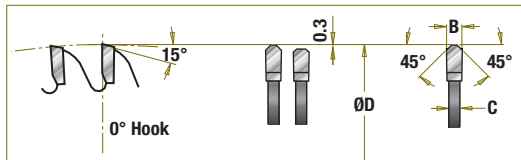

ØD		Teeth	Grind	'B' Kerf	'C' Plate	Bore	*P.H.	Tool No.	Price
Inch	mm								
10	250	72	MTC	.126	.095	5/8	—	610721	\$132.27
10	250	72	MTC	.126	.095	30mm	2/7/42 & 2/10/60	610721-30	\$132.27
12	300	84	MTC	.126	.095	1	—	612841	\$172.10
12	300	84	MTC	.126	.095	30mm	2/7/42 & 2/10/60	612841-30	\$172.10
14	350	96	MTC	.126	.102	1	—	614961	\$207.48
16	400	108	MTC	.126	.102	1	—	616109	\$244.55

NON-MELT

8" to 16"

2° Negative Hook • Modified Triple Chip (MTC) Grind

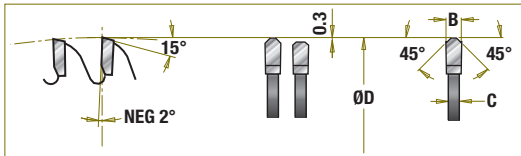

ØD		Teeth	Grind	'B' Kerf	'C' Plate	Bore	*P.H.	Tool No.	Price
Inch	mm								
8	200	64	MTC	.098	.070	5/8	—	LB86401	\$110.85
—	220	64	MTC	.126	.079	30mm	2/7/42	LB220T641 †	\$109.73
10	250	80	MTC	.100	.070	5/8	—	LB10801	\$137.27
10	250	80	MTC	.100	.070	30mm	2/7/42 & 2/10/60	LB10801-30	\$137.27
12	300	96	MTC	.125	.102	1	—	LB12961	\$160.90
12	300	96	MTC	.125	.102	30mm	2/7/42 & 2/10/60	LB12961-30	\$160.90
14	350	108	MTC	.145	.118	1	—	LB14108	\$217.18
16	400	120	MTC	.145	.118	1	—	LB16121	\$285.57

† For Holz-Her® 220mm panel saws.

AMANA NON-FERROUS METAL

8" to 18"
6° Negative Hook • Triple Chip (TC) Grind

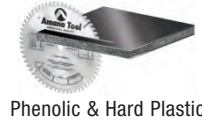
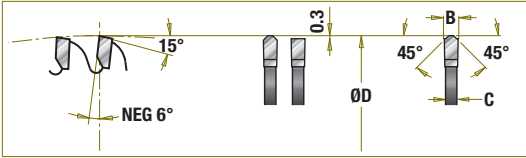

ØD		Teeth	Grind	'B' Kerf Inch	'C' Plate Inch	Bore	* P.H.	Tool No.	Price
Inch	mm								
8	200	48	TCG	.110	.087	5/8	—	584801	\$92.19
10	250	60	TCG	.126	.102	5/8	—	510601	\$116.17
10	250	60	TCG	.126	.102	30mm	2/7/42 & 2/10/60	510601-30	\$116.17
12	300	72	TCG	.126	.102	1	—	512721	\$140.49
12	300	72	TCG	.126	.102	30mm	2/7/42 & 2/10/60	512721-30	\$140.49
14	350	84	TCG	.126	.102	1	—	514841	\$168.49
16	400	96	TCG	.150	.126	1	—	516961	\$197.23
18	450	108	TCG	.157	.134	1	—	518108	\$249.06

NON-FERROUS METAL

7" to 20"
6° Negative Hook • Triple Chip (TC) Grind

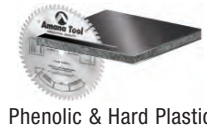
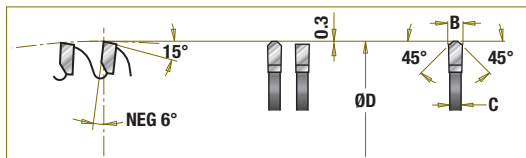

ØD		Teeth	Grind	'B' Kerf Inch	'C' Plate Inch	Bore	* P.H.	Tool No.	Price	
Inch	mm									
7	180	58	TCG	.110	.087	5/8	—	575601	\$88.90	
8	200	64	TCG	.110	.087	5/8	—	586401	\$110.92	
9	230	60	TCG	.110	.087	5/8	—	596001	\$113.23	
10	250	80	TCG	.126	.102	5/8	—	510801	\$122.33	
10	250	100	TCG	.126	.102	5/8	—	510101	\$153.58	
10	250	80	TCG	.126	.102	30mm	2/7/42 & 2/10/60	510801-30	\$153.58	
12	300	96	TCG	.126	.102	1	—	512961	\$155.14	
12	300	96	TCG	.126	.102	30mm	2/7/42 & 2/10/60	512961-30	\$155.14	
14	350	100	TCG	.146	.118	5/8	—	Pistorious	514101-5/8HD	\$222.60
14	350	108	TCG	.126	.102	1	—	—	514108	\$199.08
14	350	108	TCG	.126	.102	30mm	2/7/42 & 2/10/60	—	514108-30	\$189.60
15	375	100	TCG	.120	.098	1	—	Hitachi	515101	\$211.51
16	400	120	TCG	.150	.126	1	—	—	516121	\$237.58
18	450	120	TCG	.150	.126	1	—	—	518121	\$326.59
20	500	120	TCG	.174	.134	1	—	—	520121	\$308.46
20	500	120	TCG	.174	.152	30mm	2/7/42 & 2/10/60	—	520121-30	\$308.46

• For Hitachi Miter box (Thin Kerf).

WARNING: Never attempt to cut ferrous metals (steel, iron, etc.) with the saw blades on this page.

AMANA

RADIAL ARM

10" to 16"

0° Hook • 4 ATB & 1 Raker or ATB

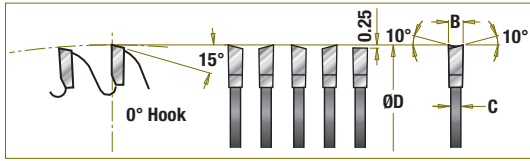

ØD		Teeth	Grind	'B' Kerf Inch	'C' Plate Inch	Bore	Tool No.	Price
Inch	mm							
10	250	24	ATB	.134	.095	5/8	RA1024	\$84.32
10	250	72	ATB	.126	.095	5/8	610720 •	\$124.60
12	300	36	ATB	.150	.110	1	RA1236	\$112.70
14	350	40	4&1	.165	.110	1	RA1440	\$142.10
14	350	42	ATB	.165	.110	1	RA1442	\$141.33
16	400	40	4&1	.165	.118	1	RA1640	\$156.87
16	400	48	ATB	.165	.118	1	RA1648	\$177.38

• For plywood use #610720.

HOLZ-HER® PANEL SAW

220mm

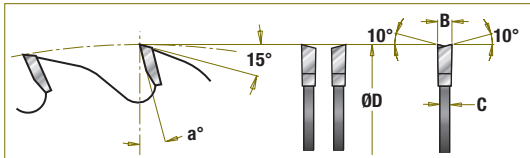

See table below for grind & hook angle.

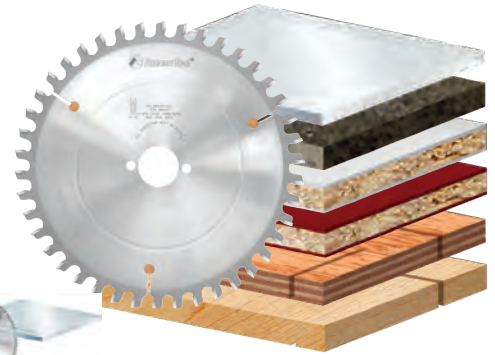
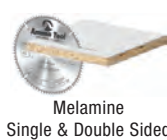

ØD mm	Teet	Grind	a°	'B' Kerf Inch	'C' Plate Inch	Bore	* P.H.	Application	Tool No.	Price
220	34	ATB	10°	.118	.079	30mm	2/7/42	General Purpose	220T340	\$90.09
220	64	ATB	10°	.118	.079	30mm	2/7/42	Crosscut Wood	220T640	\$105.07
220	64	TCG	10°	.118	.079	30mm	2/7/42	Laminate/MDF	220T641	\$110.46
220	64	TCG	-2°	.126	.0791	30mm	2/7/42	Plastic No Melt	LB220T641	\$109.73
220	42	HG	-6°	.126	.087	30mm	2/7/42	Melamine	HG220T420	\$125.69
220	42	H-ATB	-6°	.110	.087	30mm	2/7/42	Melamine	MB220T420	\$109.69

AMANA

PRESTIGE™ SUPER FINE DADO

SETS With Six 4-Wing Chippers

1/4" to 29/32" • ATB Grind

Packed In A Handy Black Molded Carrying Case

Our Prestige™ Dado Set cuts perfectly smooth edges, flat-bottom cuts and grooves both along and across the grain that are free of splinters or rough edges. This dado set is part of the renowned "Prestige™" line of superior performance blades.



Like all of the blades in our Prestige™ lineup, this *super-smooth* cutting Prestige™ dado set features the latest in cutting tool technology including massive tool-steel plates and precision ground D-10 carbide teeth. The 8" diameter, 24-tooth outside plates are hollow ground for proper clearance and feature ATB grind geometry with every sixth tooth flat ground for efficient chip removal. Each tooth body also features anti-kickback design to help prevent overfeeding.

Set accommodates today's undersized plywoods.

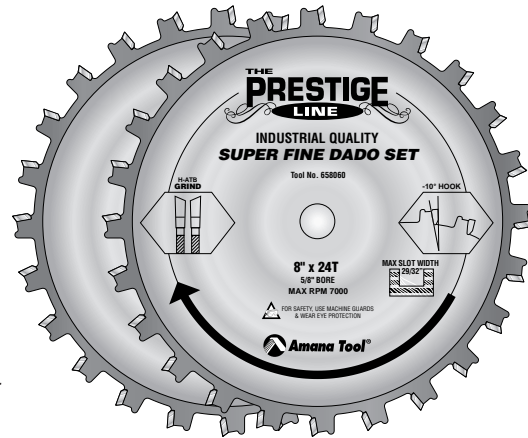

2 Outside 8" x 24T Blades

Each of the six interior chippers features four teeth and the standard width capacity is 1/4" through 29/32". Adjustments can be easily made in 1/32" increments and even finer adjustments, as small as .002", can be made by using the supplied shim set. A 46-tooth dado set (see page 256) is also available for use with plywood and melamine.

A stacking dado set is an ideal tool for cutting dadoes, grooves and tenons for strong mortise-and-tenon joinery.

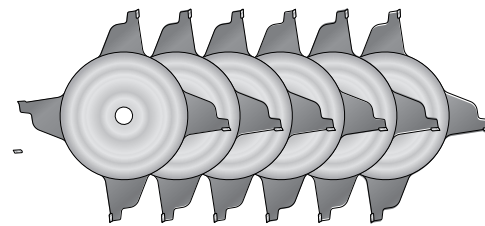

6 Carbide Tipped Four-Wing Chippers

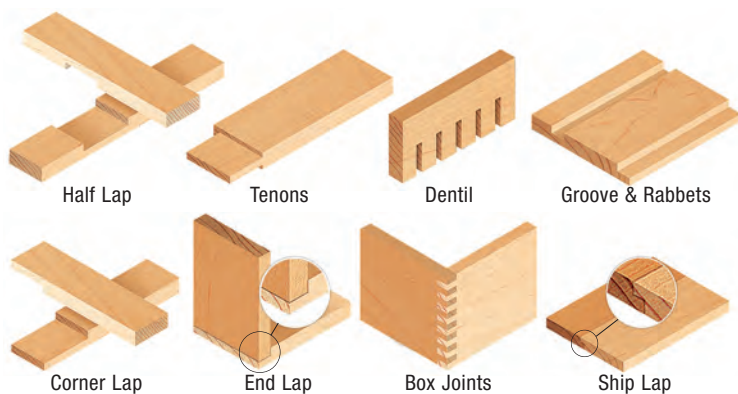

Set Includes Shim Set for Fine Adjustments

Set Accommodates Undersized Plywood

ØD	Hook Angle	*Teeth	Chippers	Grind	Kerf Range	Bore	Tool No.	Price
8	-10°	24	1/8(x4), 3/32(x1), 1/16(x1)	ATB	1/4 to 29/32	5/8	658060	\$258.27
8	-10°	24	1/8(x4), 3/32(x1), 1/16(x1)	ATB	1/4 to 29/32	1	658060-1	\$258.27

* Teeth refers to the number of teeth for each outside saw blade.

Note: Always use the outside blades. Never attempt to use the chippers without the outside blades.

AMANA

DADO SETS

6" to 12"

1/4" to 13/16" Groove ATB and FT Grind

Dado's (cross-grain cuts) and grooves (cuts with the grain) are cut efficiently on the table saw with a dado stack set. Unlike a "wobbler," a stack set produces a flat-bottom cut with chip-free edges. Amana Tool® makes dado stack sets for every machine and every type of woodworking material. The standard width capacity ranges from 1/8" to 13/16". Additional chippers may be purchased separately to expand the capacity beyond 13/16". The standard set, regardless of diameter or tooth count, consists of two outside saw blades and four inside chippers. The outside blades feature hollow-ground plates for proper clearance, and alternate top bevel (ATB) grind with every sixth tooth flat ground (FT). See charts below for additional components. For plywood and melamine, the sets with 46-tooth outside blades are recommended.

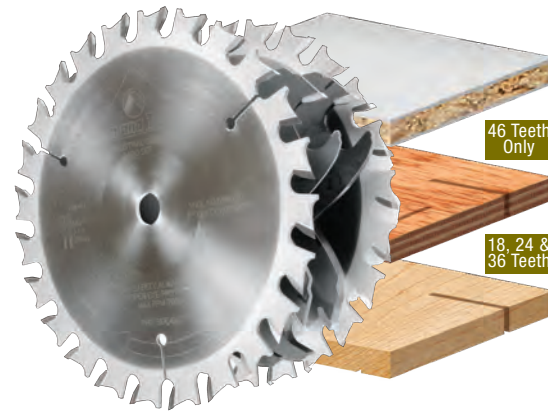

Rated excellent by:



ØD	Hook Angle	* Teeth	Grind	Kerf Range	Bore	Plastic Molded Case	Tool No.	Price
6	+15°	18	ATB/FT	1/4 to 13/16	5/8	Yes	656030	\$171.33
8	-5°	24	ATB/FT	1/4 to 13/16	5/8	Yes	658030	\$211.65
8	-5°	24	ATB/FT	1/4 to 13/16	1	Yes	658030-1	\$211.65
8	+15°	24	ATB/FT	1/4 to 13/16	5/8	Yes	658030-AK ▼	\$211.65
8	-5°	46	ATB/FT	1/4 to 13/16	5/8	Yes	658040 †	\$269.46
8	-5°	46	ATB/FT	1/4 to 13/16	1	Yes	658040-1 †	\$269.46
10	+15°	24	ATB/FT	1/4 to 13/16	5/8	No	651030	\$260.31
10	+15°	24	ATB/FT	1/4 to 13/16	1	No	651030-1	\$260.31
12	+15°	24	ATB/FT	1/4 to 13/16	1	No	651230	\$365.37

† 8" x 46T set for super smooth cuts in cabinet grade plywoods and melamine.

▼ 'Anti-Kickback' design.

* Teeth refers to the number of teeth for each outside saw blade.

Dado Combinations

Max. Width of Groove	Number of Chippers required		
	1/16	1/8	1/4
13/16	1	2	1
1-1/16	1	2	2
1-9/16	1	2	4
2-1/16	1	2	6
3-1/16	1	2	10
4-1/16	1	2	14



Handheld reusable plastic molded case & shim set included in all 6" & 8" diameter dado sets

AMANA CARBIDE-TIPPED SHAPER CUTTERS STRAIGHT EDGE

ØD	B	Ød	Tool No.	Price
2-5/8	3/4	1/2 & 3/4	912	\$68.08
3-1/8	1/4	1/2 & 3/4	917 ††	\$56.07
2-5/8	1/4	1/2 & 3/4	918 †	\$49.95
2-1/2	1/2	1/2 & 3/4	948	\$62.27
2-5/8	3/8	1/2 & 3/4	953 †	\$49.35
2-5/8	1/2	1/2 & 3/4	954	\$68.88
2-5/8	1	1/2 & 3/4	955	\$76.86
2-5/8	1-1/2	1/2 & 3/4	956	\$83.23
2	1	1/2	SC610	\$46.17
2-7/8	1/4	1/2 & 3/4	SC611	\$32.80
2	1/4	1/2	SC612	\$29.09
2-7/8	1/4	1 & 1-1/4	SC613	\$34.97
2	1/2	1/2	SC614	\$36.33
3-9/16	1/4	1 & 1-1/4	SC615	\$39.97
2-5/8	2	1/2 & 3/4	SC632	\$69.97
2-3/4	1/4	1/2 & 3/4	SC671	\$34.97
1-7/8	1/4	1/2 & 3/4	SC672	\$27.97
3-3/8	1/4	1 & 1-1/4	SC673	\$34.97
2-1/2	1/4	1 & 1-1/4	SC674	\$33.57

† Due to size, furnished with only one 1/2" x 3/4" bushing. †† Cabinet set replacement cutter, no bushing is furnished.

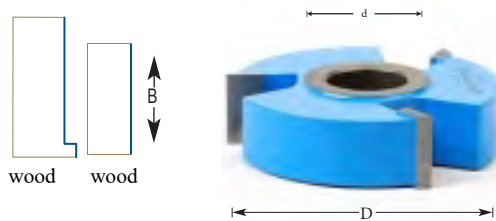

HEAVY-DUTY STRAIGHT EDGE

ØD	B	Ød	Tool No.	Price
4	1/4	1-1/4	A-27-100	\$49.67
4	3/8	1-1/4	A-27-102	\$51.24
4	1/2	1-1/4	A-27-104	\$60.87
4	3/4	1-1/4	A-27-106	\$68.88
4	1	1-1/4	A-27-108	\$68.88
4	1-1/4	1-1/4	A-27-110	\$78.51
4	1-3/4	1-1/4	A-27-114	\$76.02
4	2	1-1/4	A-27-116	\$83.44

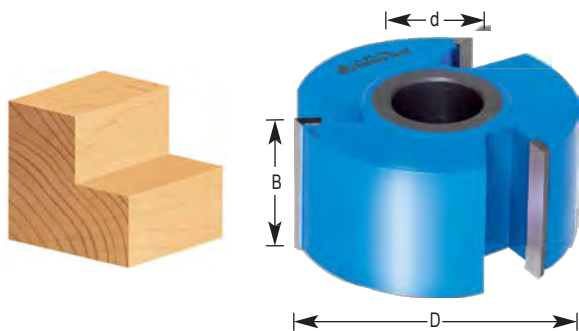

3D renderings & tool illustrations not shown at actual size.

PRESTIGE™ MIGHTY ADJUSTABLE SUPER-FINE DADO/GROOVER SET

For Shapers • Accommodates Undersized Plywood
4 Wing • ATB & FT Grind • 1/4" to 1"

ØD	Hook Angle	Teeth	ATB Angle	Grind	Kerf Range
4	-10°	4	15°	ATB	1/4 to 1

Ød	Groovers	RPM	Tool No.	Price
3/4	1/16, 1/8, 3/16, 1/4	6,100-10,500	61370*	\$232.93

* Includes shimset #67254.

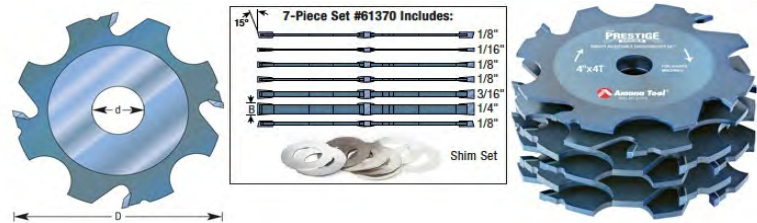

GROOVERS 4-WING FT GRIND

ØD	Hook Angle	B	Teeth	Ød	Max t	RPM	Tool No.	Price
4	15°	1/16	4	3/4	1-1/4	6,100-10,500	61372	\$42.53
4	15°	1/8	4	3/4	1-1/4	6,100-10,500	61374	\$46.80
4	15°	3/16	4	3/4	1-1/4	6,100-10,500	61376	\$49.56
4	15°	1/4	4	3/4	1-1/4	6,100-10,500	61378	\$54.46

19-Piece Shim Set for 3/4 Bore Prestige Mighty Dados (#67254) \$21.25

Quantity	Shims	Color	Inch	mm	Ød	ØD
5		Silver	0.002	0.05	3/4	2-1/4
6		Clear	0.010	0.25	3/4	2-1/4
8		White	0.020	0.50	3/4	2-1/4

CORNER ROUND

ØD	ØD1	B	R	R1	Ød	Rub	Tool No.	Price
2-5/8	1-5/8	15/16	1/4	1/2	1/2 & 3/4	C-005**	905	\$76.67
3-5/32	2-5/32	15/16	1/4	1/2	1,1/4	C-051**	SC680	\$65.63

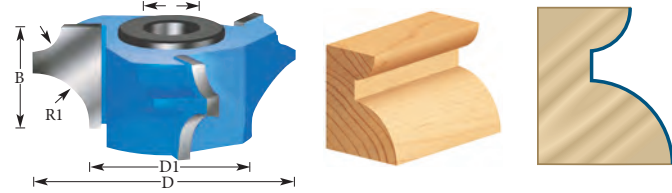

COVE & CORNER ROUND

ØD	ØD1	B	B1	T	T1	R	R1	Ød	Rub Collar	Tool No.	Price
2-5/8	2	15/16	1/8	1/2	5/16	1/2	5/16	1/2 & 3/4	C-005**	950	\$53.80
2-3/4	1-3/4	1-3/8	3/8	1/2	1/2	1/2	1/2	1/2 & 3/4	C-006**	SC410	\$72.80
3	1-3/4	1-9/16	5/16	5/8	5/8	5/8	5/8	1/2 & 3/4	C-006**	SC412	\$95.17
3-1/4	1-3/4	1-7/8	3/8	3/4	3/4	3/4	3/4	1/2 & 3/4	C-006**	SC414	\$118.97
3-3/4	1-3/4	2-1/4	1/4	1	1	1	1	1/2 & 3/4	C-006**	SC416	\$185.82

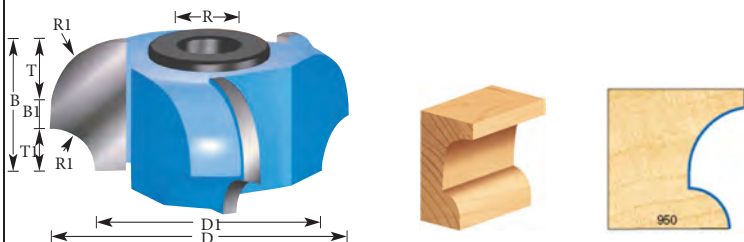

AMANA 3-Wing Flute & Cove

ØD	B	B1	R	Ød	Tool No.	Price
2	1	1/4	1/2	1/2	SC600	\$51.28

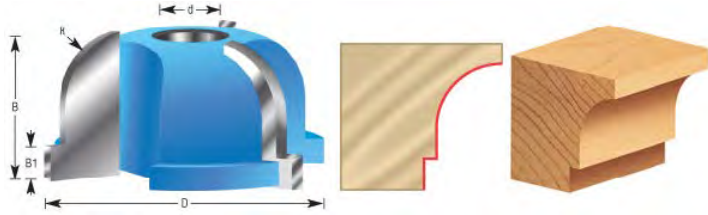

5/16" COVE & 3/8" BEAD

ØD	B	R	R1	Ød	Rub Collar	Tool No.	Price
2-5/8	1	3/8	5/16	1/2 & 3/4	C-010**	951	\$37.14

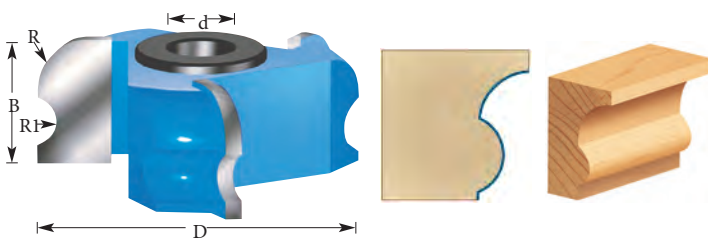

1/8" TO 3/8" CORNER ROUND & 1/4" BEAD

ØD	ØD1	B	R	R1	Ød	Rub Collar	Tool No.	Price
2	1-1/4	1	3/8	1/8	1/2	C-002**	SC602	\$34.97
2-5/8	1-7/8	15/16	3/8	1/8	1/2 & 3/4	C-008**	952	\$68.88

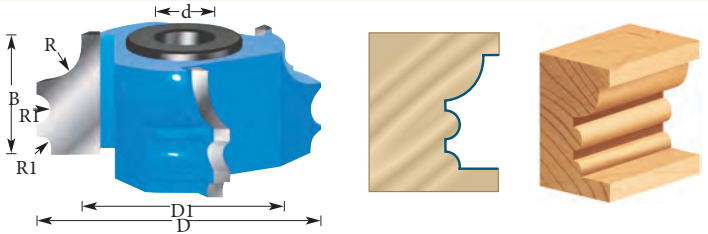

DROP LEAF COVE

ØD	B	R	Ød	Rub Collar	Tool No.	Price
2-5/8	1	3/8	1/2 & 3/4	C-038	SC634	\$56.77

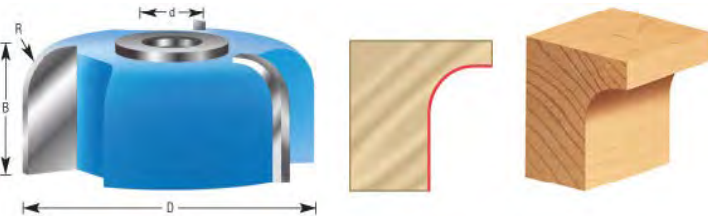

STAIR TREAD NOSE

ØD	ØD1	B	B1	R	Ød	Rub Collar	Tool No.	Price
3-3/8	1-7/8	1-1/2	1-1/8	9/16	1/2 & 3/4	C-008**	932	\$93.45

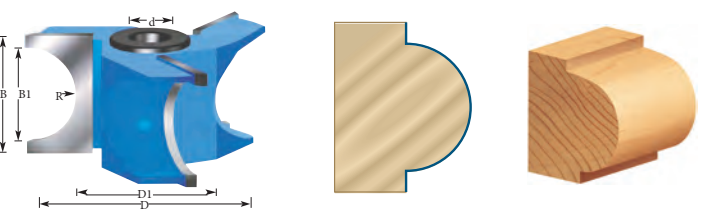

3D renderings & tool illustrations not shown at actual size.

CORNER ROUND

Description	ØD	ØD1	B	R	Ød	Rub Collar	Tool No.	Price
Corner Round	4	3-3/4	3/8	1/8	1-1/4	C-038	A-30-100	\$41.20
Corner Round	4	3-5/8	7/16	3/16	1-1/4	C-037	A-30-102	\$48.97
Corner Round	4	3-1/2	1/2	1/4	1-1/4	C-035	A-30-104	\$63.53
Corner Round	4	3-3/8	9/16	5/16	1-1/4	C-034	A-30-106	\$53.17
Corner Round	4	3-1/4	5/8	3/8	1-1/4	C-033	A-30-108	\$62.97
Corner Round	4	3	3/4	1/2	1-1/4	C-032	A-30-110	\$69.97
Corner Round	4	2-3/4	7/8	5/8	1-1/4	C-031	A-30-112	\$79.07
Corner Round	4	2-1/2	1	3/4	1-1/4	C-017	A-30-114	\$97.97
Corner Round	4-1/2	2-1/2	1-1/4	1	1-1/4	C-017	A-30-116	\$93.84
Corner Round	3-5/8	2-1/8	1	3/4	1/2 & 3/4	C-011**	959	\$74.17
Drop Leaf-Bead	2-5/8	1-5/8	1	1/2	1/2 & 3/4	C-005**	SC636	\$60.55

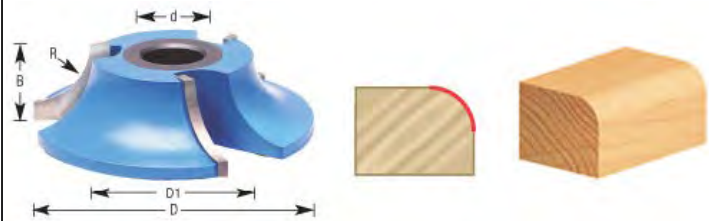

BULL NOSE

ØD	ØD1	B	B1	R	Ød	Rub Collar	Tool No.	Price
3	2-11/16	7/16	5/16	5/32	1/2 & 3/4	C-019**	SC424	\$34.97
2-5/8	2-3/8	9/16	1/4	1/8	1/2 & 3/4	C-015**	973 †	\$43.65
2-5/8	2-1/4	5/8	3/8	3/16	1/2 & 3/4	C-025**	974	\$65.28
2-5/8	2-1/8	13/16	1/2	1/4	1/2 & 3/4	C-011**	925	\$63.28
2-5/8	2	15/16	5/8	5/16	1/2 & 3/4	C-010**	923	\$68.08
2-5/8	1-7/8	1-1/16	3/4	3/8	1/2 & 3/4	C-008**	927	\$69.06
2-5/8	1-5/8	1-1/2	1	1/2	1/2 & 3/4	C-005**	929	\$72.10
3-9/16	2-5/16	1-5/8	1-1/4	5/8	1 & 1-1/4	C-040***	SC570	\$116.45
3-13/16	2-5/16	2	1-1/2	3/4	1 & 1-1/4	C-040***	SC572	\$198.94
4-5/16	2-5/16	2-1/2	2	1	1 & 1-1/4	C-040***	SC574	\$227.05

† Duetto size, furnished with only one 1/2" x 3/4" bushing.

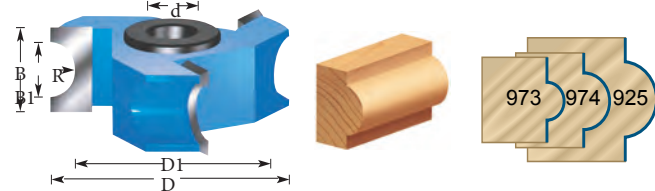

HEAVY-DUTY BEAD

ØD	ØD1	R	B	B1	Ød	Rub Collar	Tool No.	Price
4	3-3/4	1/8	1/2	1/4	1-1/4	C-038	A-29-100	\$54.32
4	3-5/8	3/16	5/8	3/8	1-1/4	C-037	A-29-102	\$58.03
4	3-1/2	1/4	13/16	1/2	1-1/4	C-035	A-29-104	\$68.88
4	3-1/4	3/8	1-1/8	3/4	1-1/4	C-033	A-29-106	\$80.08
4	3	1/2	1-5/16	1	1-1/4	C-032	A-29-108	\$102.52
3-7/8	2-3/8	9/16	1-1/2	1-1/8	1-1/4	C-020	A-29-109	\$103.85

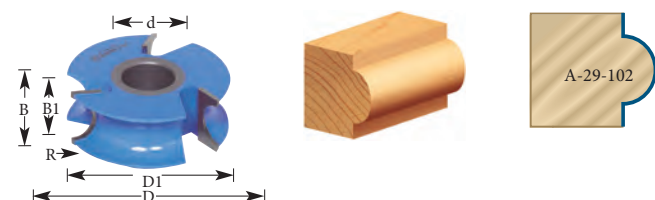

AMANA FLUTE (CONVEX)

Description	ØD	B	R	Ød	Rub Collar	Tool No.	Price
1/4 Flute	2-5/8	1/4	1/8	1/2 & 3/4	C-015**	971	\$42.84
3/8 Flute	2-5/8	3/8	3/16	1/2 & 3/4	C-025**	972	\$47.74
1/2 Flute	2-5/8	1/2	1/4	1/2 & 3/4	C-011**	926	\$53.27
3/4 Flute	2-5/8	3/4	3/8	1/2 & 3/4	C-008**	928	\$69.06
1-1/4 Flute	3-1/4	1-1/4	5/8	1 & 1-1/4	C-050***	SC532	\$69.06
1-1/2 Flute	3-1/2	1-1/2	3/4	1 & 1-1/4	C-050***	SC534	\$69.06
1 Flute	2-5/8	1	1/2	1/2 & 3/4	C-005**	930	\$72.10
2 Flute	4	2	1	1 & 1-1/4	C-050***	SC536	\$176.58
1/4 Flute	4	1/4	1/8	1-1/4	C-038	A-28-100	\$46.17
1/2 Flute	4	1/2	1/4	1-1/4	C-035	A-28-104	\$62.97
3/4 Flute	4	3/4	3/8	1-1/4	C-033	A-28-106	\$66.36
1 Flute	4	1	1/2	1-1/4	C-032	A-28-108	\$62.97

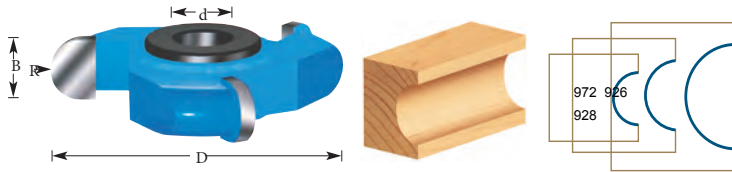

CORNER TRIPLE BEAD

ØD	ØD1	B	C	R	Ød	Rub Collar	Tool No.	Price
2-5/8	1-1/2	7/8	9/16	3/16	1/2 & 3/4	C-043**	SC624	\$55.97

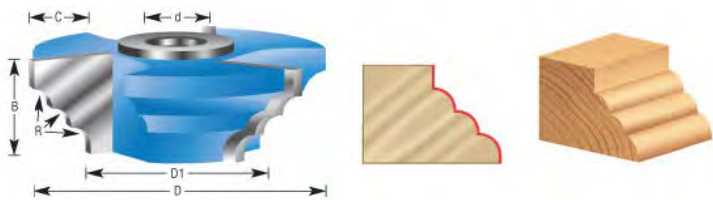

REVERSIBLE/MATCHED COVE & BEAD

ØD	ØD1	B	B1	C	R	Ød	Rub Collar	Tool No.	Price
3	1-3/4	3/4	1/2	5/8	15/64	1/2 & 3/4	C-006**	968	\$107.31
3	1-3/4	15/16	3/8	5/8	15/64	1/2 & 3/4	C-006**	SC646	\$95.17

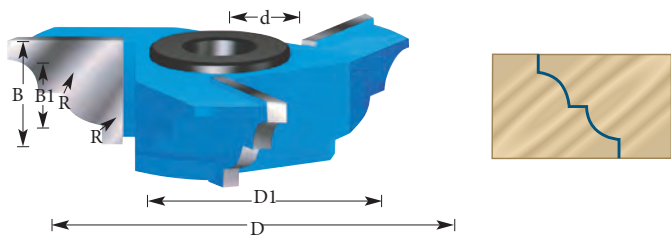

REVERSIBLE/MATCHED OGEE

ØD	ØD1	B	B1	C	R	Ød	Rub Collar	Tool No.	Price
3-1/4	1-3/4	7/8	3/8	3/4	1/2	1/2 & 3/4	C-006**	969	\$107.31
3-3/8	1-7/8	15/16	3/8	3/4	1/2	1/2 & 3/4	C-008**	SC648	\$67.17

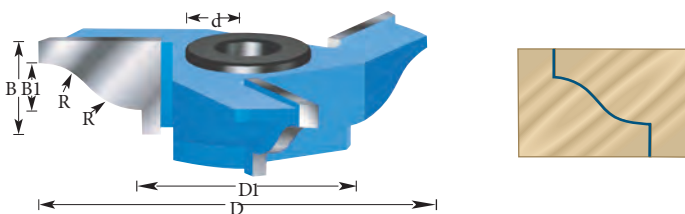

3D renderings & tool illustrations not shown at actual size.

MATCHED/REVERSIBLE OGEE

ØD	B	B1	R	Ød	Rub Collar	Tool No.	Price
2-5/8	3/4	1/2	1/4	1/2 & 3/4	C-005**	906	\$70.04
3-1/8	3/4	1/2	1/4	1 & 1-1/4	C-051**	SC682	\$60.55

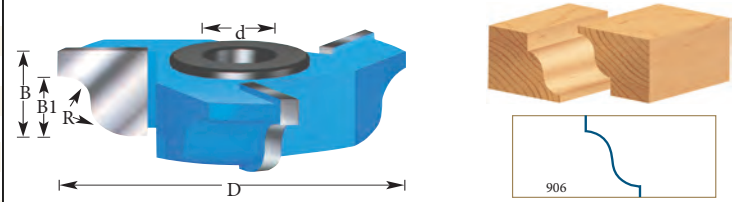

WAVE EDGE

ØD	ØD1	B	C	R	R1	R2	Ød	Rub Collar	Tool No.	Price
2-3/4	1-5/8	1	9/16	3/16	1/4	1/8	1/2 & 3/4	C-005**	SC626	\$62.97

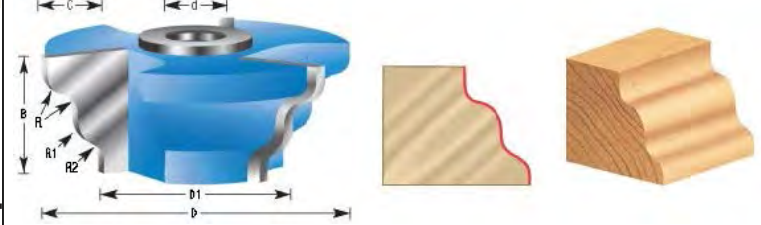

ROUNDED FLUTE

ØD	ØD1	B	R	R1	Ød	Rub Collar	Tool No.	Price
2-5/8	2-5/16	1	3/32	3/16	1/2 & 3/4	C-013**	SC628	\$37.59

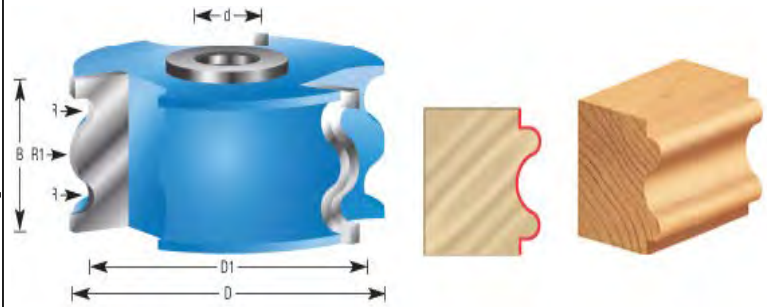

OGEE & BEAD TABLE EDGE

ØD	ØD1	B	B1	R	R1	Ød	Rub Collar	Tool No.	
3-1/4	2-1/8	1	3/4	1/2	1/8	1/2 & 3/4	C-007**	958	\$53.17

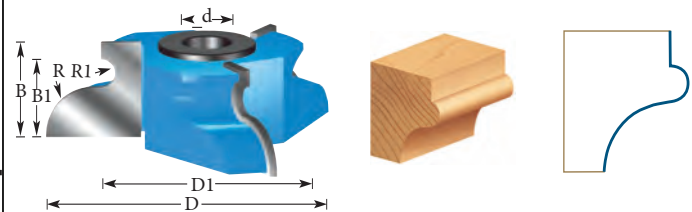

CROWN MOLDING

ØD	B	a°	R	Ød	Rub Collar	Tool No.	Price
3-1/4	2-1/4	45°	1-1/4	1/2 & 3/4	C-030**	967	\$195.90

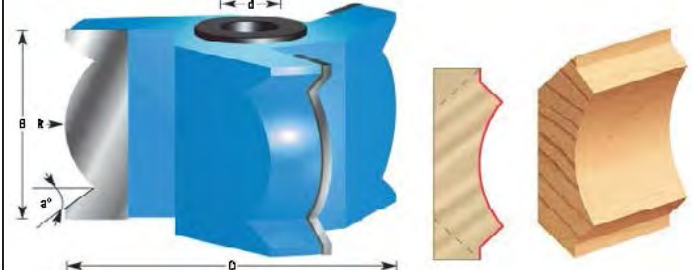

AMANA CROWN MOLDING

ØD	B	B1	a°	R	R1	Ød	Rub Collar	Tool No.	Price
2-3/4	2-1/4	2	45°	1/2	3/16	1/2 & 3/4	C-027**	962	\$163.17
3-1/2	2-1/2	2-1/4	45°	13/32	11/32	1 & 1-1/4	—	SC664	\$163.38
3-1/2	3	2-3/4	45°	17/32	11/32	1 & 1-1/4	—	SC662	\$182.88
3-1/2	3-1/2	3-1/4	45°	9/16	1/2	1 & 1-1/4	—	SC660	\$235.69

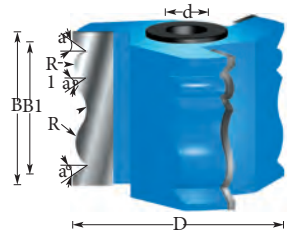

MULTI-FORM

ØD	ØD1	B	R	R1	R2	Ød	Rub Collar	Tool No.	Price
3-1/2	2-7/8	1-7/8	1/4	5/16	3/8	1/2 & 3/4	C-007**	965	\$187.39

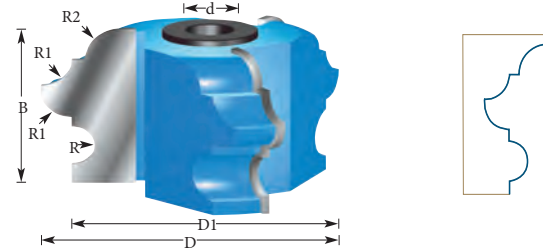

MOLDING

ØD	B	R	R1	R2	Ød	Rub Collar	Tool No.	Price
3	1-3/4	1/8	5/32	1/4	1/2 & 3/4	C-010**	966	\$142.66

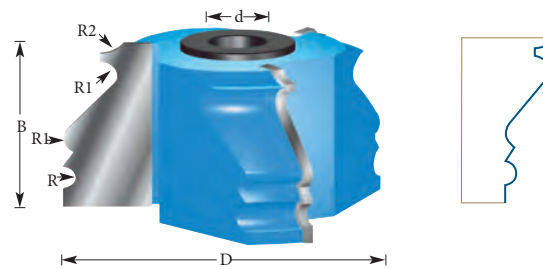

MOLDING

ØD	ØD1	B	C	R	R1	Ød	Rub Collar	Tool No.	Price
2-5/8	1-3/4	15/16	7/16	1/4	3/16	1/2 & 3/4	C-006**	SC630	\$187.39

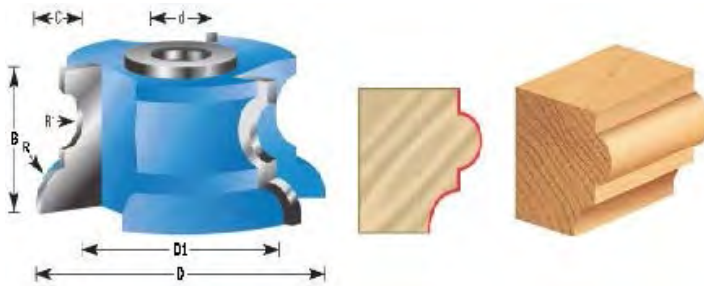

3D renderings & tool illustrations not shown at actual size.

BASE MOLDING

ØD	ØD1	B	R	R1	R2	L	Ød	Rub Collar	Tool No.	Price
3-1/2	2-7/8	1-7/8	1/4	5/16	3/8	7/8	1/2 & 3/4	C-007**	965	\$187.39

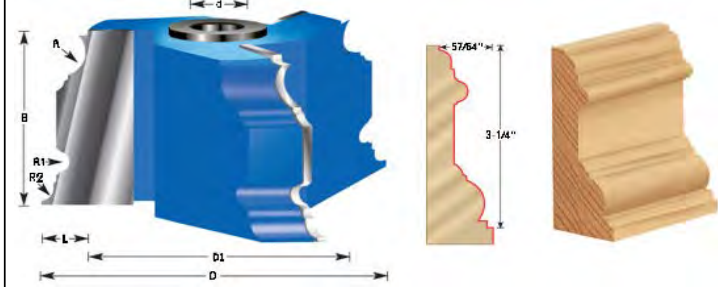

WINDOW SASH

With Ball Bearing Rub Collar

ØD	B	B1	B2	B3	R	Ød	Rub Collar	Tool No.	Price
2	1-5/8	5/16	3/8	5/8	1/4	1/2 & 3/4	C-043**	939	\$143.64

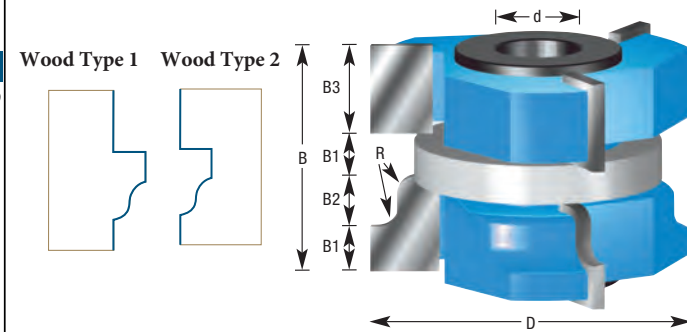

SASH

Description	ØD	ØD1	B	R	Ød	Rub Collar	Tool No.	Price
Female Sash	2-5/8	2-1/8	5/8	1/8	1/2 & 3/4	C-024**	975	\$62.37
Male Sash	2-5/8	2-1/8	5/8	1/8	1/2 & 3/4	C-024**	976	\$74.17

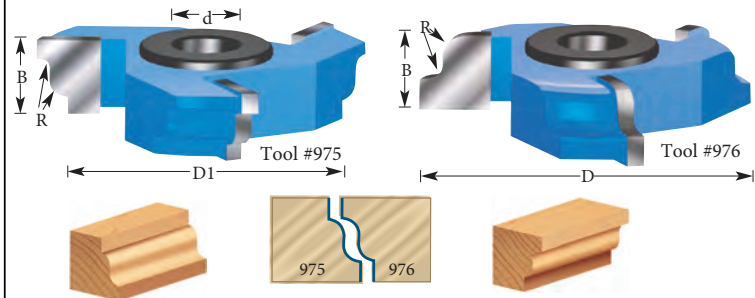

FINGER JOINT

ØD	ØD1	B	B1	L	Ød	Rub Collar	Tool No.	Price
2-7/8	2-1/8	1-1/2	11/32	3/8	1/2 & 3/4	C-011**	999	\$118.09
3	2-1/4	1-1/2	13/64	3/8	1 & 1-1/4	---	SC300	\$110.53

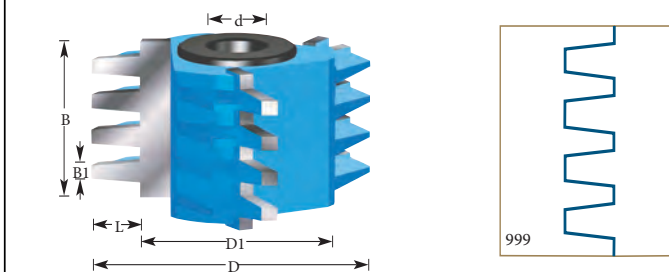

AMANA JOINERY Wedge Tongue & Groove

ØD	ØD1	B	B1	Ød	Rub Collar	Tool No.	Price
2-5/8	2	15/16	11/32	1/2 & 3/4	C-010**	903	\$79.24

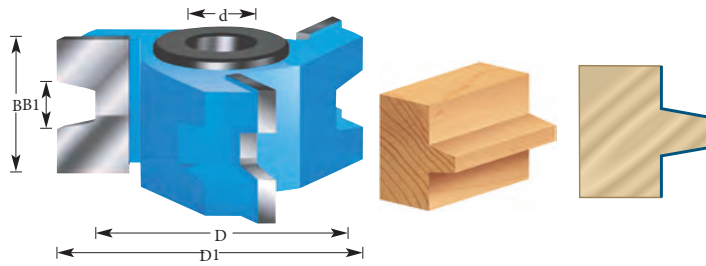

ØD	ØD1	B	B1	Ød	Rub Collar	Tool No.	Price
2-5/8	2	15/16	11/32	1/2 & 3/4	C-010**	904	\$65.70

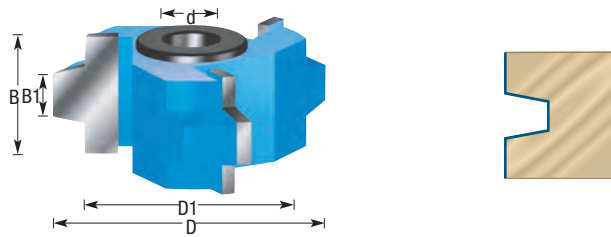

GLUE JOINT

ØD	ØD1	B	B1	Ød	Rub Collar	Tool No.	Price
2-5/8	2-1/4	1-3/16	3/8	1/2 & 3/4	C-026**	911	\$70.18
2-13/16	2-1/2	1-3/16	3/8	1 & 1-1/4	C-017**	SC617	\$67.83

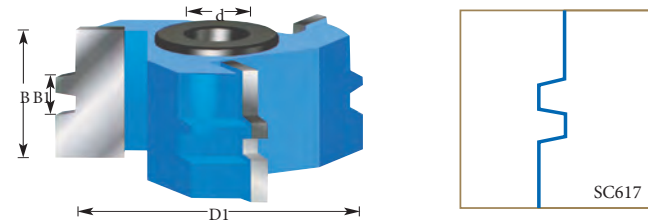

ØD	ØD1	B	B1	Ød	Rub Collar	Tool No.	Price
2-5/8	2-3/8	3/4	11/32	1/2 & 3/4	C-014**	933	\$57.68

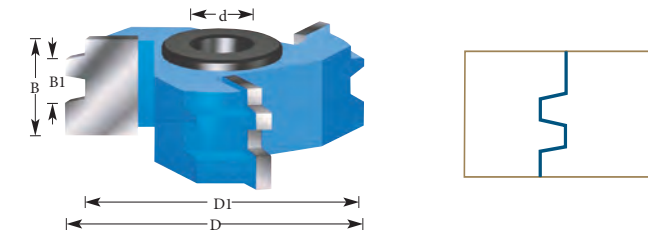

CLASSICAL

ØD	ØD1	B	B1	Ød	Rub Collar	Tool No.	Price
2-5/8	2	1	3/8	1/2 & 3/4	C-004**	964	\$69.37

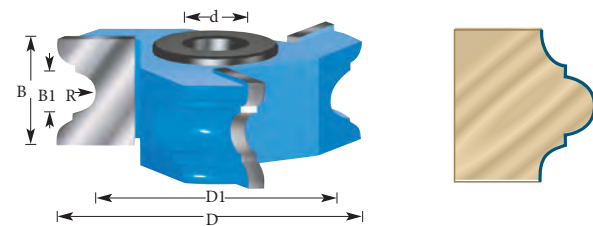

3D renderings & tool illustrations not shown at actual size.

LOCK MITER

ØD	ØD1	B	B1	a°	Ød	Rub Collar	Tool No.	Price
3-3/4	2	1	3/8	45°	1/2 & 3/4	C-006**	998	\$124.95
4-17/32	2-31/64	1	3/8	45°	1 & 1-1/4	C-017**	SC619	\$103.18

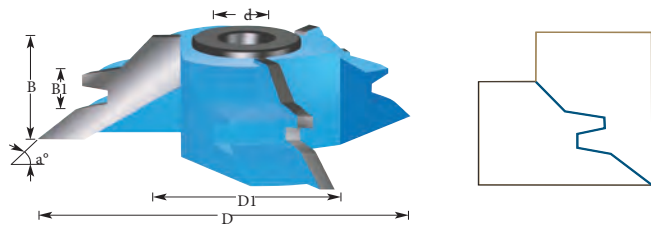

DOOR LIP Corner Round & Rabbet (counter-clockwise, rabbet up)

ØD	ØD1	B	B1	R	a°	Ød	Rub Collar	Tool No.	Price
2-5/8	1-3/4	1-3/16	5/8	3/8	10°	1/2 & 3/4	C-006**	900	\$48.02

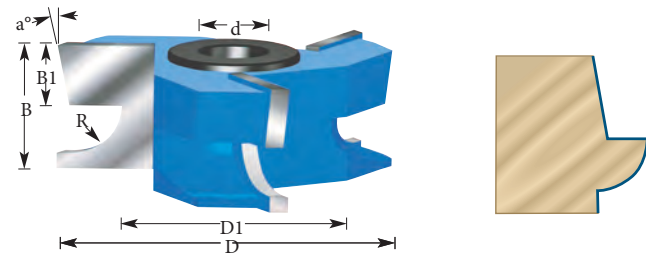

Corner Round & Taper Rabbet (counter-clockwise, rabbet down)

ØD	ØD1	B	B1	R	a°	Ød	Rub Collar	Tool No.	Price
2-5/8	1-3/4	1-1/4	11/16	3/8	10°	1/2 & 3/4	C-006**	901	\$48.02

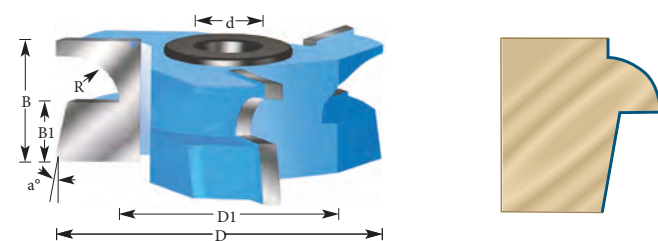

ØD	ØD1	B	B1	R	a°	Ød	Rub Collar	Tool No.	Price
2-5/8	2	1	7/16	1/8	10°	1/2 & 3/4	C-006**	991	\$74.17

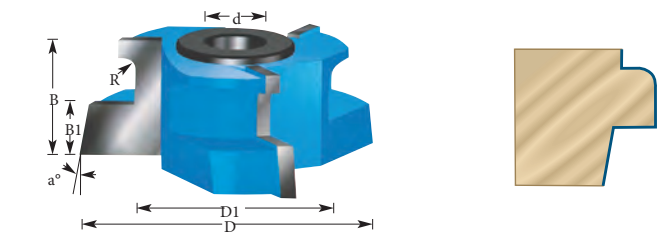

Corner Round & Ogee

ØD	ØD1	B	B1	Ød	Rub Collar	Tool No.	Price
2-5/8	2-1/4	1	13/16	1/2 & 3/4	C-023**	992	\$68.88

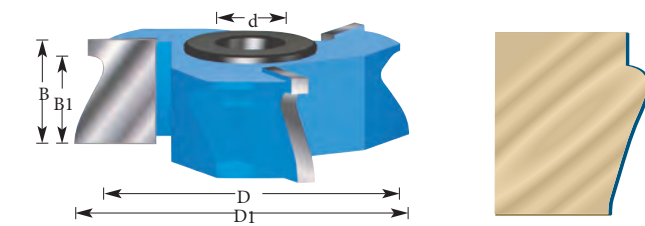

AMANA Door Lip Ogee & Cove

ØD	ØD1	B	Ød	Rub Collar	Tool No.	Price
2-5/8	1-1/2	1	1/2 & 3/4	47806**	993	\$53.45

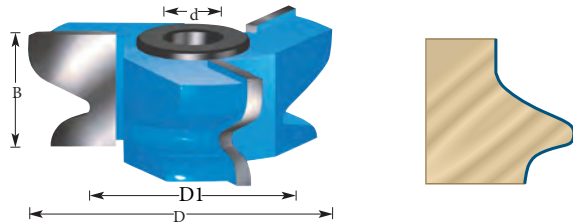

Ogee & Cove

ØD	ØD1	B	B1	C	R	R1	Ød	Tool No.	Price
4-5/16	3-1/8	1-1/32	9/32	3/8	1/4	1/8	1 & 1-1/4	SC462	\$90.97

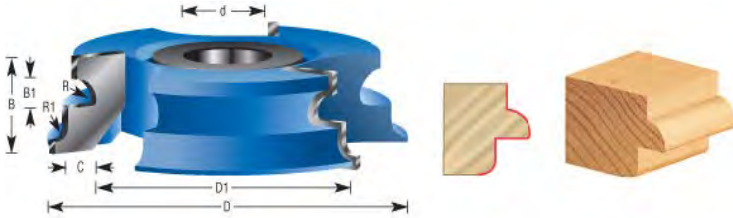

ØD	ØD1	B	B1	C	R	Ød	Tool No.	Price
4-5/16	3-1/8	1-1/32	3/8	13/32	1/8	1 & 1-1/4	SC464	\$69.97

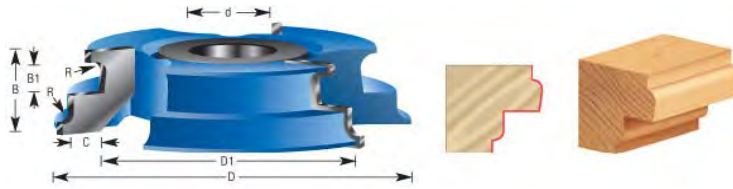

90° 'V' GROOVE

ØD	B	a°	Ød	Rub Collar	Tool No.	Price
2-5/8	15/16	45°	1/2 & 3/4	47810**	957	\$82.25

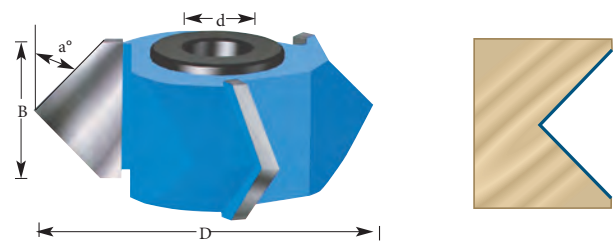

BEVEL

Description	ØD	ØD1	B	a°	Ød	Rub Collar	Tool No.	Price
30° Bevel	2-5/8	1-3/8	1	30°	1/2 & 3/4	C-044**	977	\$69.02
45° Bevel	3-1/2	1-1/2	1	45°	1/2 & 3/4	C-011**	SC618	\$107.83
45° Bevel	4	2	1	45°	1 & 1-1/4	C-050**	SC621	\$111.30

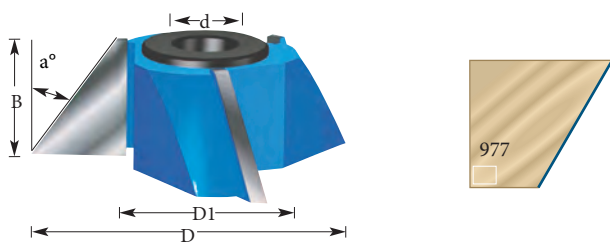

3D renderings & tool illustrations not shown at actual size.

BEVEL

ØD	ØD1	B	B1	a°	C	Ød	Rub Collar	Tool No.	Price
2-5/8	1-11/16	1-3/16	15/16	90°	15/32	1/2 & 3/4	C-005**	SC638	\$67.17

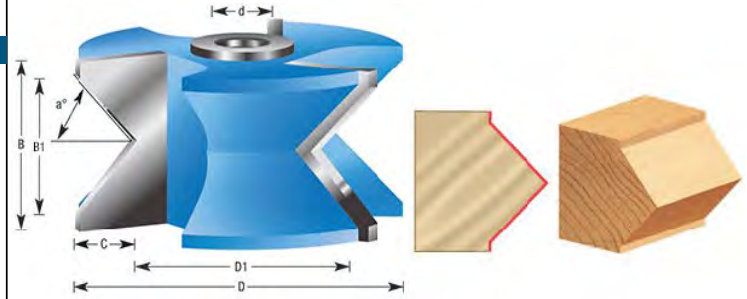

TRIPLE BEAD

ØD	B	B1	R	Ød	Rub Collar	Tool No.	Price
2-5/8	1	5/8	5/64	1/2 & 3/4	C-015**,C-028**	960	\$71.44

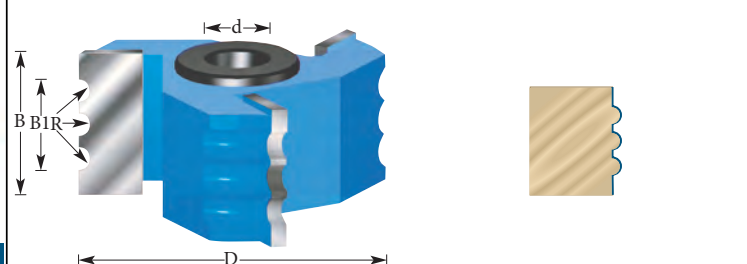

TRIPLE FLUTING

ØD	B	B1	R	Ød	Rub Collar	Tool No.	Price
2-5/8	1	5/8	5/64	1/2 & 3/4	C-015**,C-028**	961	\$71.44

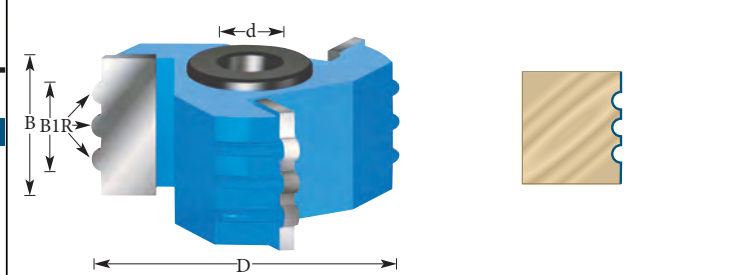

WAINSCOT/PANELING

For 3/4" Material

ØD	ØD1	B	a°	T	T1	L	Ød	Rub Collar	Tool No.	Price
3-1/2	3	1	45°	1/4	3/8	1/4	1/2 & 3/4	C-016**	SC420 (SET)	\$239.68

Wainscot With 'V' Cutters

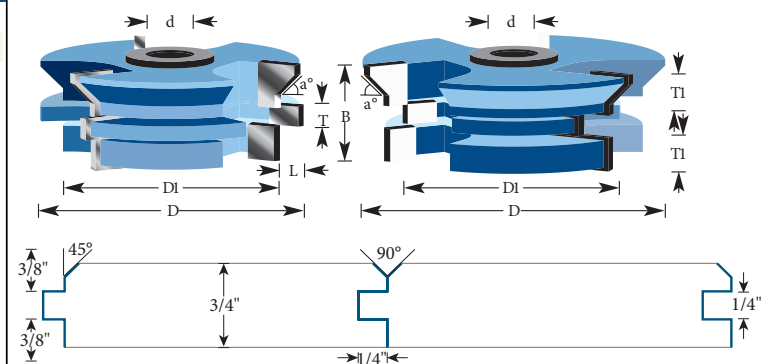

AMANA Wainscot With Bead Cutters

ØD	ØD1	ØD2	B	T	T1	R	L	L1	Ød	Rub Collar	Tool No.	Price
3	2-1/2	2-5/8	1	1/4	3/8	—	1/4	3/16	1/2 & 3/4	47822**	SC430 (SET)	\$201.85
3	2-11/16	2-5/8	7/16	1/16	5/16	5/32	—	—	1/2 & 3/4	C-019**	SC424	\$34.97

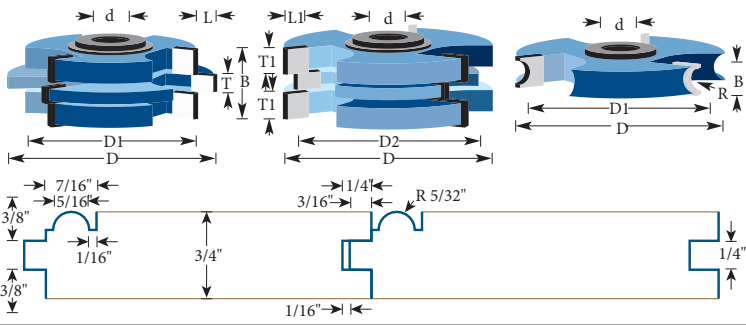

Wainscot with V & Bead Cutters

ØD	ØD1	B	a°	T	T1	R	L	Ød	Rub Collar	Tool No.	Price
3	2-5/8	1	—	1/4	3/8	—	3/16	1/2 & 3/4	47822**	SC432	\$104.97
3	2-1/2	1	45°	3/8	1/4	—	1/4	1/2 & 3/4	C-016**	SC422	\$111.97
2-13/16	2-5/8	25/32	45°	5/16	1/4	5/32	7/32	1/2 & 3/4	C-016**	SC422	\$111.97

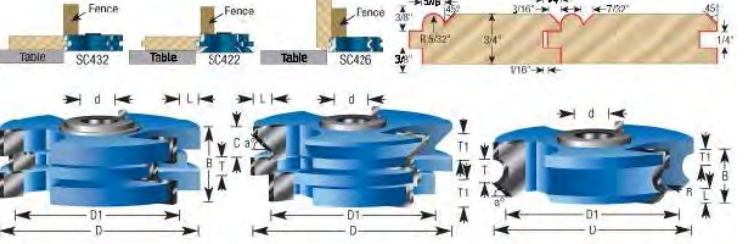

FLOORING SET WITH NAIL SLOT FOR 5/8" TO 3/4" MATERIAL

ØD	ØD1	ØD2	C	C1	T	R	R1	Ød	Rub Collar	Tool No.	Price
3-1/4	2-25/32	7/8	1/4	11/32	1/4	1/8	1/16	1/2 & 3/4	C-029, C-014**	SC450	\$178.33
3-1/4	2-13/16	7/8	1/4	11/32	1/4	1/8	1/16	1-1/4	C-042, C-040***	SC451	\$203.77
2-5/8	2-21/32	7/8	1/4	—	1/4	1/8	1/16	3/4	—	SC453	\$149.96

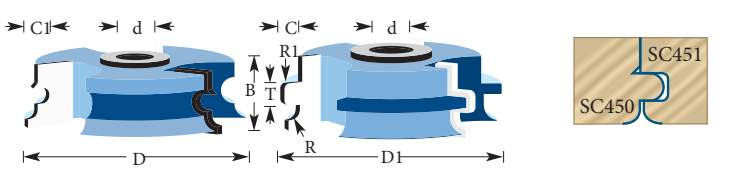

'V' PANELING 2-PIECE SETS With 1/4"W x 3/8"D Tongue & Groove

ØD	ØD1	ØD2	B	a°	Ød	Rub Collar	Tool No.	Price
2-5/8	2-1/4	1-1/2	29/32	45°	1/2 & 3/4	C-008**	938	\$181.09

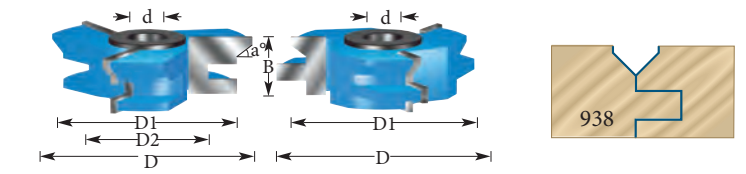

ØD	ØD1	B	C	a°	Ød	Rub Collar	For Material	Tool No.	Price
2-5/8	1-1/8	3/4	7/16	45°	1/2 & 3/4	C-006, C-011**	1/2	SC640	\$121.30
2-3/4	2	1	5/8	45°	1/2 & 3/4	C-010, C-043*	3/4	SC642	\$157.68

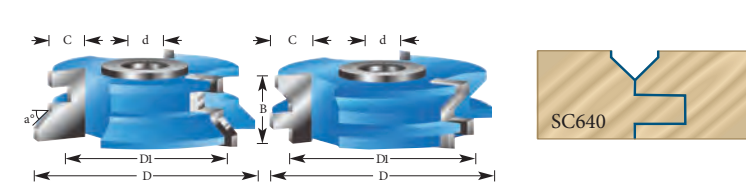

Reversible Stile&Rail Cabinet Door Sets With Ball Bearing (For 3/4" to 1" Material) Roman Ogee

ØD	B	R	T	C	L	Ød	Repl. Ball Bearing	Tool No.	Price
2-13/32	1	5/16	1/4	3/8	3/8	1/2 & 3/4	47757 (42mm*3/4 *9mm)	SC586	\$57.19
2-29/32	1	5/16	1/4	3/8	5/8	1/2 & 3/4	47757 (42mm*3/4 *9mm)	SC579	\$60.17

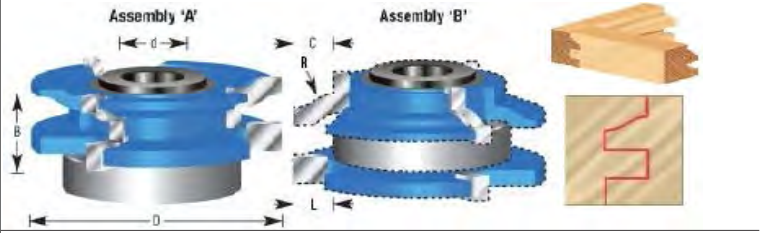

Tongue & Groove

ØD	B	R	T	C	L	Ød	Repl. Ball Bearing	Tool No.	Price
2-13/32	3/4	—	1/4	3/8	3/8	1/2 & 3/4	47757 (42mm*3/4 *9mm)	SC577	\$54.57

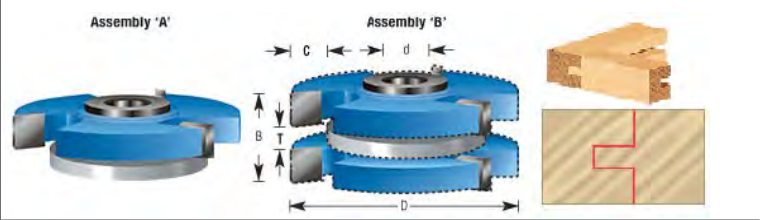

Bevel

ØD	B	a°	T	C	L	Ød	Repl. Ball Bearing	Tool No.	Price
2-13/32	1	18.6°	1/4	3/8	3/8	1/2 & 3/4	47757 (42mm*3/4 *9mm)	SC587	\$57.19
2-7/8	1	45°	1/4	3/8	5/8	1/2 & 3/4	47757 (42mm*3/4 *9mm)	SC597	\$61.28

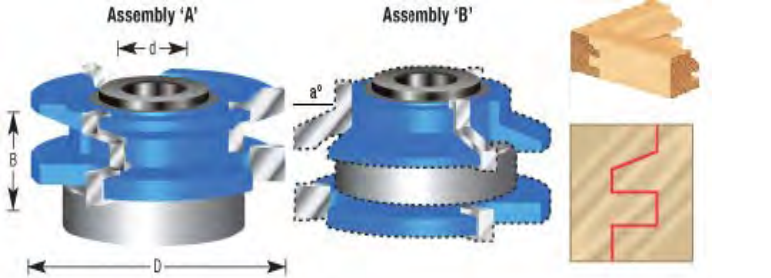

Classical

ØD	B	R	T	C	L	Ød	Repl. Ball Bearing	Tool No.	Price
2-13/32	1	9/64	1/4	3/8	3/8	1/2 & 3/4	47757 (42mm*3/4 *9mm)	SC588	\$57.19

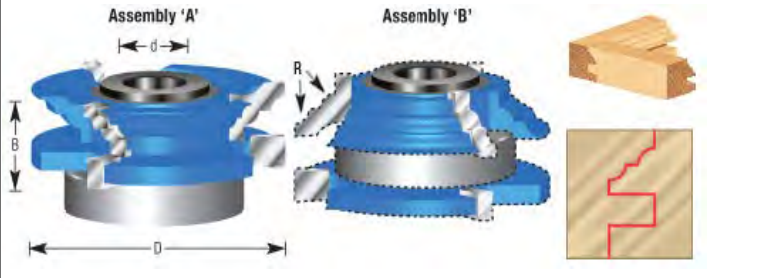

Convex/Concave

ØD	B	R	T	C	L	Ød	Repl. Ball Bearing	Tool No.	Price
2-13/32	1	3/16	1/4	3/8	3/8	1/2 & 3/4	47757 (42mm*3/4 *9mm)	SC589	\$57.19

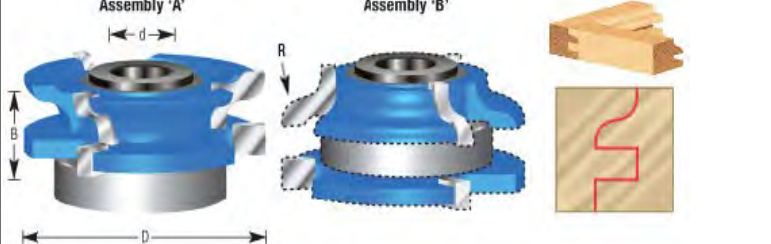

AMANA

STILE & RAIL CABINET DOOR SETS FOR 5/8" TO 3/4" MATERIAL Concave With Eased Edge

ØD	ØD1	B	T	L	R	Ød	Rub Collar	Tool No.	Price
3	2-9/32	3/4	1/4	11/32	1/4	1/2 & 3/4	C-014**	SC441	\$191.24

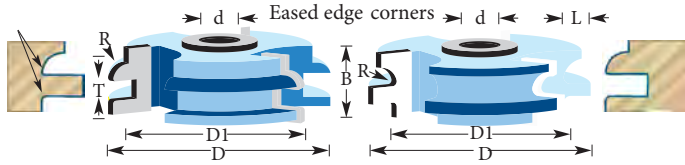

*Counter-Clockwise With Wood Face Up for both Stile and Rail Cutters

STILE & RAIL CABINET DOOR SETS FOR 3/4" TO 1" MATERIAL Concave

ØD	C	B	T	L	R	Ød	Rub Collar	Tool No.	Price
2-11/16	1/4	1	1/4	7/16	1/4	1/2 & 3/4	C-009**	SC440	\$199.68
3-9/16	1/4	1	1/4	7/16	1/4	1 & 1-1/4	C-019,C-021***	SC540	\$216.55

Concave

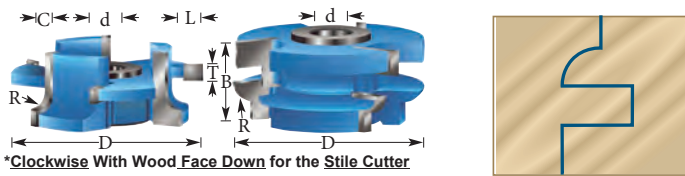

*Clockwise With Wood Face Down for the Stile Cutter

*Counter-Clockwise With Wood Face Down for the Rail Cutter

Concave

ØD	C	B	T	L	R	Ød	Rub Collar	Tool No.	Price
3-9/16	1/4	1	1/4	7/16	13/64	1 & 1-1/4	C-019,C-021**	SC550	\$206.15

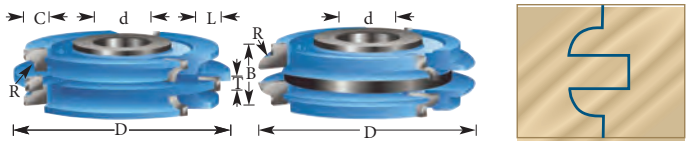

Ogee

Ø	B	T	L	R	Ø	Rub Collar	Tool No.	Price
2-11/16	1	1/4	7/16	1/8	1/2 & 3/4	C-007,C-012***	SC444	\$200.12

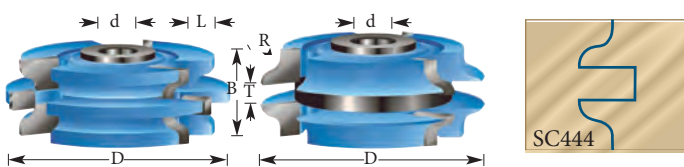

STILE & RAIL CABINET DOOR SETS FOR 3/4" MATERIAL Bead

Bead

ØD	C	B	T	L	R	Ød	Rub Collar	Tool No.	Price
2-11/16	3/8	1	1/4	7/16	9/32	1/2 & 3/4	C-007,C-010***	SC446	\$208.11
3-9/16	3/8	1	1/4	7/16	9/32	1 & 1-1/4	C-019,C-020***	SC546	\$225.02

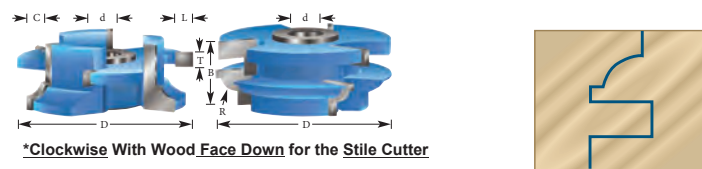

*Clockwise With Wood Face Down for the Stile Cutter

*Counter-Clockwise With Wood Face Down for the Rail Cutter

3D renderings & tool illustrations not shown at actual size.

Ogee

ØD	C	B	T	L	R	R1	Ød	Rub Collar	Tool No.	Price
2-11/16	3/8	1	1/4	7/16	5/16	3/16	1/2 & 3/4	C-007,C-010***	SC442	\$208.11
3-9/16	3/8	15/16	1/4	7/16	1/4	3/16	1 & 1-1/4	C-019,C-020***	SC542	\$212.24

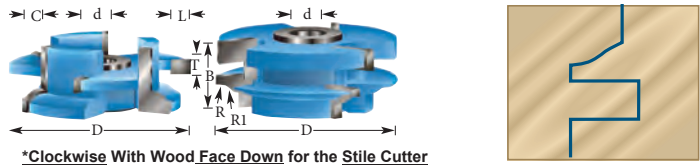

*Clockwise With Wood Face Down for the Stile Cutter

*Counter-Clockwise With Wood Face Down for the Rail Cutter

GLASS DOOR & MULLION SET

For SC442 And SC446

Ø	ØD1	B	Ød	Tool No.	Price
2-7/8	1-13/16	1/2	3/4	SC445	\$71.60

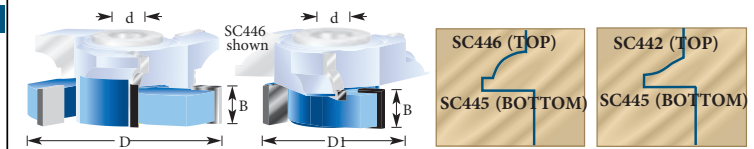

Ogee

ØD	C	B	T	L	R	Ød	Rub Collar	Tool No.	Price
3-9/16	3/8	1	1/4	7/16	9/64	1 & 1-1/4	C-019,C-020***	SC548	\$212.23

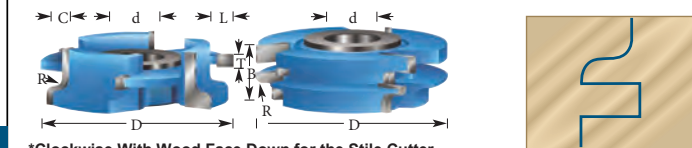

*Clockwise With Wood Face Down for the Stile Cutter

*Counter-Clockwise With Wood Face Down for the Rail Cutter

ADJUSTABLE TONGUE & GROOVE CABINET DOOR SETS

5/8" TO 1-1/4" MATERIAL

Shaker and Arts & Crafts

ØD	ØD1	B	C	T	L	Ød	Rub Collar	Tool No.	Price
2-3/8	1-5/8	1 to 1-5/16	7/16	3/16 to 9/32	3/8	1/2 & 3/4	C-005**	SC555	\$295.47
2-59/64	2-5/32	1-1/16 to 1-21/64	7/16	3/16 to 9/32	3/8	1 & 1-1/4	C-051***	SC553	\$319.45

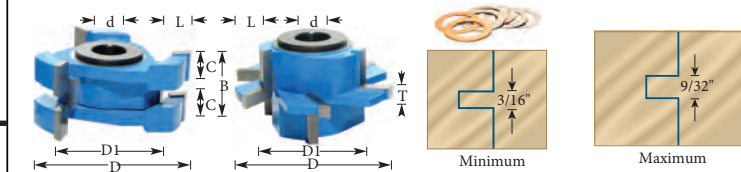

Accommodates Undersized Plywood

Straight With 22.5° Bevel (Shaker)

ØD	ØD1	B	C	T	L	Ød	Rub Collar	Tool No.	Price
2-3/8	1-5/8	1-1/16 to 1-21/64	7/16	3/16 to 9/32	3/8	1/2 & 3/4	C-005**	SC565	\$303.17

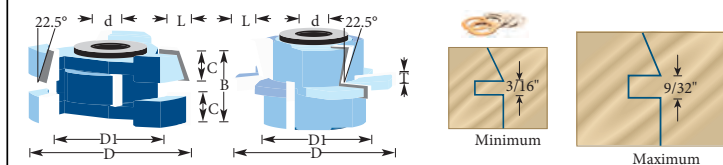

AMANA ADJUSTABLE TONGUE & GROOVE CABINET DOOR SETS

5/8" TO 1-1/4" MATERIAL

Accommodates Undersized Plywood
Concave

ØD	ØD1	B	R	C	T	L
2-3/8	1-57/64	1-1/16 to 1-21/64	15/64	7/16	3/16 to 9/32	3/8

Ød	Rub Collar	Tool No.	Price
1/2 & 3/4	C-005**	SC568	\$322.63

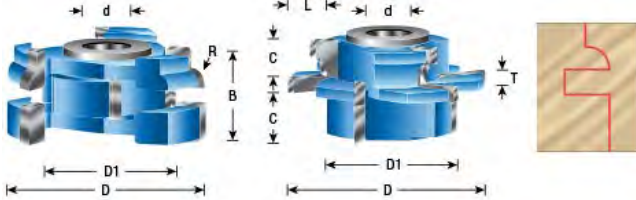

5/8" TO 2-1/8" MATERIAL Mission Style – Shaker And Arts & Crafts

ØD	ØD1	B	C	T	L	Ød	Rub Collar	For Material	Tool No.	Price
2-3/4	1-7/8	1	3/8	1/4	7/16	1/2 & 3/4	C-008**	5/8 to 1	SC554	\$232.02
3-3/8	2-1/2	1-1/8	7/16	1/4	7/16	1 & 1-1/4	C-017***	5/8 to 1-1/8	SC556	\$256.31
2-3/4	1-7/8	1-3/4	11/16	3/8	7/16	1/2 & 3/4	C-008**	3/4 to 1-3/4	SC558	\$233.38
3-1/4	2-3/8	1-3/4	11/16	3/8	7/16	1 & 1-1/4	C-041***	3/4 to 1-3/4	SC557	\$245.66
3-1/2	2-1/2	2-1/8	13/16	1/2	1/2	1 & 1-1/4	C-017***	1 to 2-1/8	SC559	\$316.02

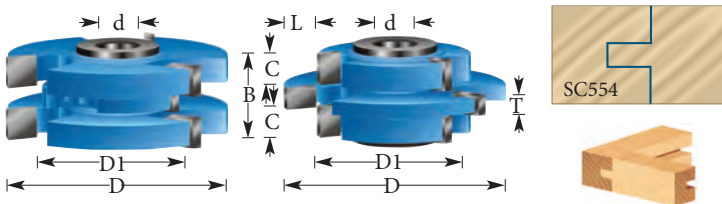

STILE & RAIL CABINET DOOR SET FOR 1" To 1-3/8" MATERIAL

Bead

ØD	C	B	T	L	R	Ød	Rub Collar	Tool No.	Price
3-9/16	3/8	1-3/8	1/4	7/16	9/32	1 & 1-1/4	C-019***	SC562	\$254.68

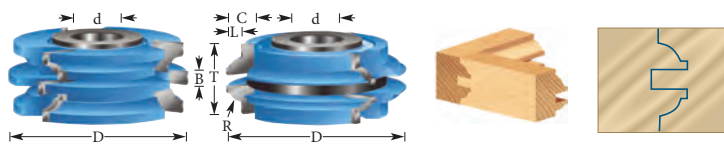

STILE & RAIL CABINET DOOR SET FOR 1" To 1-3/16" MATERIAL

Ogee

ØD	C	B	T	L	R	Ød	Rub Collar	Tool No.	Price
3-9/16	3/8	1-3/16	1/4	7/16	5/32	1 & 1-1/4	C-019***	SC564	\$281.23

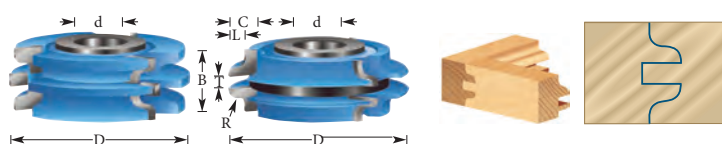

3D renderings & tool illustrations not shown at actual size.

STILE & RAIL CABINET DOOR SETS FOR 1" TO 1-3/4" MATERIAL

Cabinet Molding Set With 1/4"W X 3/8"D Tongue & Groove

ØD	ØD1	B	B1	R	R1	Ød	Rub Collar	Tool No.	Price
2-5/8	1-7/8	1-13/16	1	1/8	5/32	1/2 & 3/4	C-008**	921	\$256.38

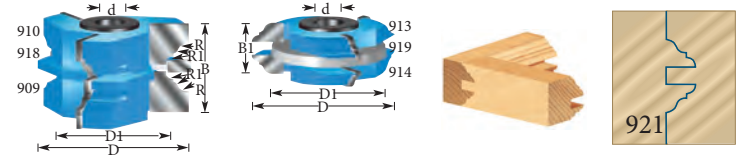

STILE & RAIL CABINET DOOR SETS FOR 7/8" TO 1-3/16" MATERIAL

Concave

ØD	C	B	T	L	R	Ød	Rub Collar	Tool No.	Price
2-7/8	1/4	1-3/16	1/4	7/16	15/64	1/2 & 3/4	C-009***	SC460	\$218.30

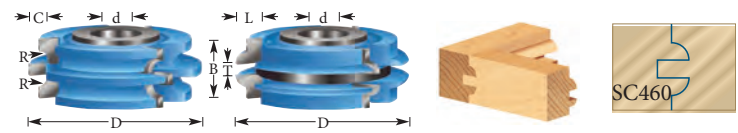

STILE & RAIL CABINET DOOR SETS FOR 1-5/16" MATERIAL

Ogee Stile & Rail Set With 1/4"W x 5/16"D Tongue & Groove

ØD	D1	D2	B	R	R1	Ød	Rub Collar	Tool No.	Price
3-1/8	1-7/8	2-1/2	1-5/16	3/16	5/32	1/2 & 3/4	C-008, C-016**	994	\$317.14

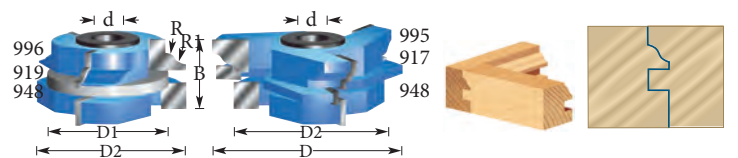

STILE & RAIL CABINET DOOR SET FOR 1-5/16" MATERIAL

Concave Stile & Rail Set

With 1/4"W x 5/16"D Tongue & Groove

ØD	D1	D2	B	R	Ød	Rub Collar	Tool No.	Price
2-1/2	1-7/8	3-1/8	1-17/64	5/16	1/2 & 3/4	C-008**, C-016**	940	\$284.87

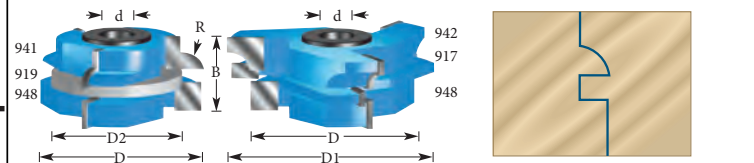

STILE & RAIL CABINET DOOR SETS FOR 1-3/8" MATERIAL

Ogee

ØD	B	D1	T	L	R	Ød	Rub Collar	Tool No.	Price
3-9/16	1-1/2	—	1/4	9/16	3/16	1 & 1-1/4	C-017***	SC580	\$298.17
3-9/16	1-3/4	2-1/2	1/2	17/32	3/16	1 & 1-1/4	C-017***	SC581	\$321.38

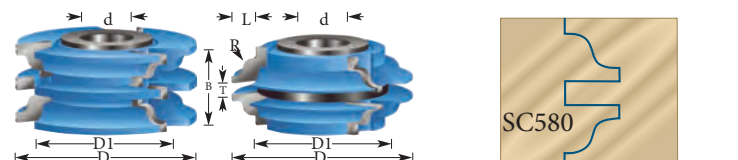

AMANA STILE & RAIL CABINET DOOR SETS FOR 1-9/16" MATERIAL

Bead

ØD	D1	B	L	C	C1	R	Ød	T	Rub Collar	Tool No.	Price
2-27/32	1-27/32	1-9/16	1/2	17/32	1/8	5/16	1/2 & 3/4	7/32	C-007**	SC582	\$278.92
3-9/16	2-9/16	1-9/16	1/2	17/32	1/8	5/16	1 & 1-1/4	7/32	C-018***	SC583	\$303.21

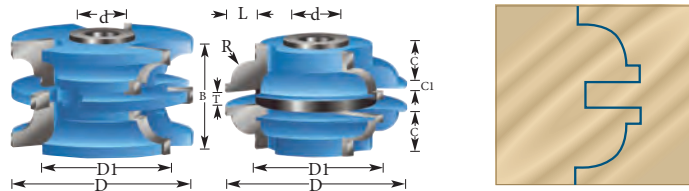

STILE & RAIL EXTERIOR DOOR SETS FOR 1-3/4" MATERIAL

Cove & Bead Set

With 1/4"W x 17/32"D Tongue & Groove

ØD	ØD1	ØD2	ØD3	B	R	R1	Ød	Rub Collars	Tool No.	Price
3-1/8	1-7/8	2-5/16	2-1/16	1-3/4	15/64	11/32	1/2 & 3/4	C-008,C-022**	922	\$334.50

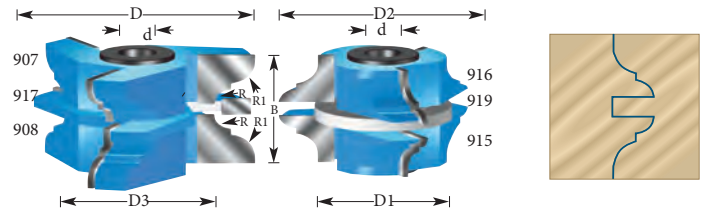

STILE & RAIL CABINET DOOR SETS FOR 1-3/8" MATERIAL

Bead & Cove

ØD	ØD1	C	B	T	L	R	Ød	Rub Collars	Tool No.	Price
3-1/16	2-1/32	33/64	1-9/16	1/4	9/16	3/16	1/2 & 3/4	C-039**	SC585	\$278.92
3-9/16	—	7/8	1-5/8	1/4	9/16	13/64	1 & 1-1/4	C-018***	SC584	\$291.06

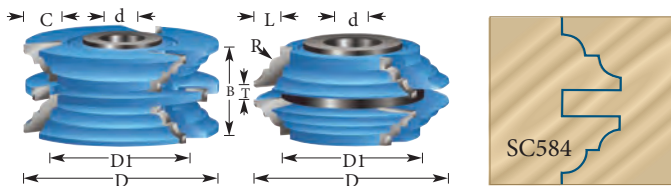

STILE & RAIL EXTERIOR DOOR SETS FOR 1-3/4" TO 2-1/8" MATERIAL

Bead

ØD	ØD1	C	B	T	L	R	Ød	Rub Collar	Tool No.	Price
2-7/8	1-13/16	17/32	2	1/4	9/16	25/64	1/2 & 3/4	C-007**	SC592	\$315.29
3-11/32	2-5/16	33/64	1-31/32	1/4	9/16	25/64	1 & 1-1/4	C-040***	SC593	\$327.45
3-17/32	2-17/32	1/2	2-1/8	1/2	1/2	25/64	1 & 1-1/4	C-018***	SC596	\$363.83

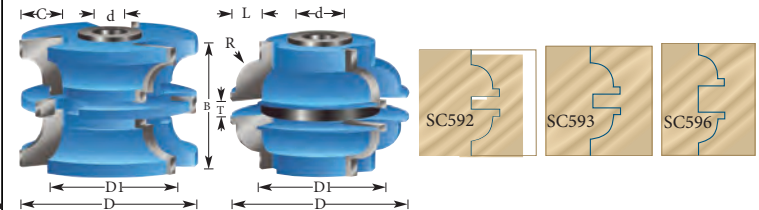

STILE & RAIL CABINET DOOR SET FOR 1-3/8" MATERIAL

Convex Stile & Rail Set

With 1/4"W X 5/16"D Tongue & Groove 3-Wing

ØD	ØD1	ØD2	B	R	Ød	Rub Collar	Tool No.	Price
3-1/8	1-7/8	2-1/2	1-23/64	5/16	1/2 & 3/4	C-008, C-016**	945	\$172.83

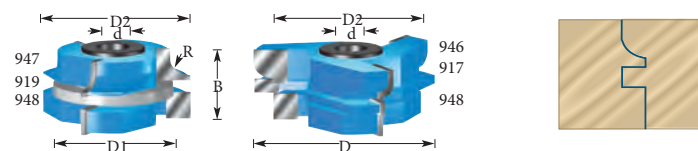

STILE & RAIL EXTERIOR DOOR SET FOR 2" MATERIAL

Ogee

ØD	B	T	L	R	Ød	Rub Collars	Tool No.	Price
3-9/16	2-1/16	1/4	9/16	1/4	1 & 1-1/4	C-018***	SC594	\$333.50

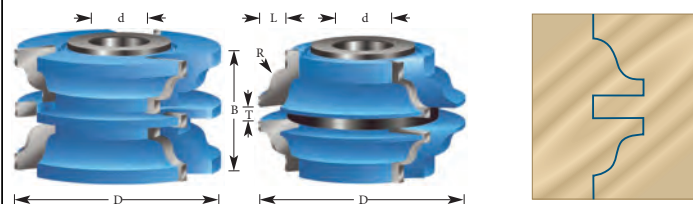

STILE & RAIL EXTERIOR DOOR SET FOR 1-3/4" MATERIAL

Bead & Cove

ØD	C	B	T	L	R	Ød	Rub Collar	Tool No.	Price
2-7/8	1/2	1-3/4	1/4	1/2	21/64	1/2 & 3/4	C-008**	SC590	\$295.26

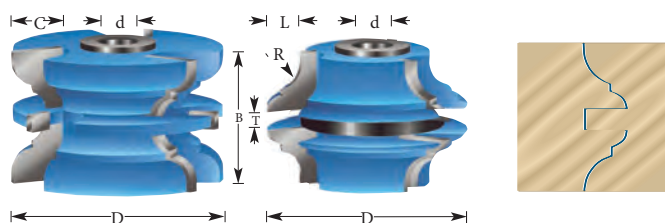

RAISED PANEL BACK

With Ball Bearing Rub Collar

ØD	B	R	Ød	Rub Collar	Tool No.	Price
3-1/2	1/2	1/4	1/2 & 3/4	C-006**	980	\$100.00
3-39/64	1/2	1/4	1 & 1-1/4	C-045***	989	\$102.73

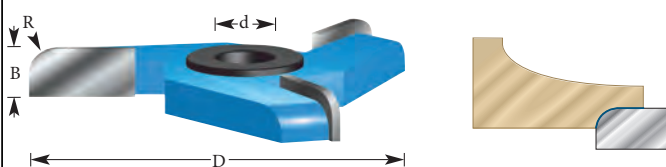

3D renderings & tool illustrations not shown at actual size.

AMANA

Safety Guidelines for Shaper Cutters:

1. Always make sure the machine is disconnected from the power source while going through these important steps.
2. Always refer to your machine owner's manual prior to using your shaper. Learn the machines' applications and limitations as well as the potential hazards.
3. Always wear eye and hearing protection. Keep clothing clear of cutting area.
4. Make certain that the stock is not warped or twisted and is free of any knots, nails, screws, staples, grit or any other foreign object.
5. Always examine the cutters of dull, worn or damaged knives. Never use a dull, worn or damaged tool.
6. When using insert tooling, be sure all knives are installed correctly and securely tightened. Never make adjustments to cutters or knives while shaper is plugged in.
7. Check the direction of the cutter rotation. The sharp leading edge of the knife should be the first to touch the material
8. Always be sure the spindle nut is securely tightened
9. Never feed the material in the same direction that the cutter head rotates.
10. Make sure that both the in feed and out feed fences are in alignment with each other.
11. Carefully rotate the spindle by hand to be sure that your cutters clear the fence and guards. Never make adjustments to shaper while cutters are turning or the power is on.
12. Always use the safety guards supplied with your machinery. Never remove any safety guards or safety devices. Never make any cuts freehand!
13. Allow at least a minimum safety distance of 4 inches between the cutters and your hands when cutting material. Always use push blocks or sticks when working with small or narrow pieces.
14. Never stand behind the material being shaped.
15. Avoid shaping stock less than 10 inches in length.
16. Hold down the material firmly and feed it into the cutters with a constant and steady feed rate. Do not over-reach.
17. Always feed the material against the cutters. Never remove any stock until the entire length has passed completely through the cutters.
18. Failure to follow safety instructions and warnings could result in serious bodily injury or death.

RAISED PANEL FOR 5/8" MATERIAL

Traditional

ØD	B	C	R	a°	Ød	Rub Collar	Tool No.	Price
4-5/8	5/8	1-3/16	5/32	5°	1/2 & 3/4	C-005***	SC650	\$95.17
5-1/2	5/8	1-1/2	1/8	6°	1 & 1-1/4	C-017***	SC518	\$109.17

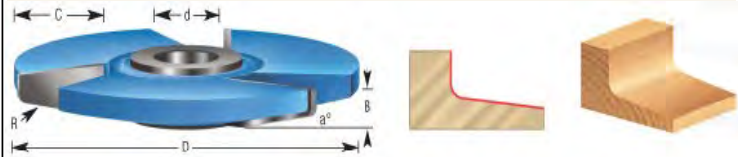

RAISED PANEL FOR 5/8" MATERIAL

Ogee

ØD	B	C	R	Ød	Rub Collar	Tool No.	Price
4-5/8	5/8	1-3/16	1-1/2	1/2 & 3/4	C-005***	SC654	\$232.02
5-1/2	5/8	1-1/2	1-9/16	1 & 1-1/4	C-017***	SC520	\$109.17

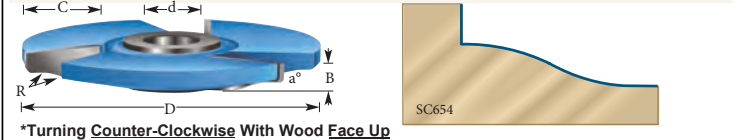

Classical

ØD	B	C	R	a°	Ød	Rub Collar	Tool No.	Price
4-5/8	5/8	1-3/16	1/8	12°	1/2 & 3/4	C-005***	SC656	\$95.17
5-1/2	5/8	1-1/2	5/32	7°	1 & 1-1/4	C-017***	SC522	\$109.17

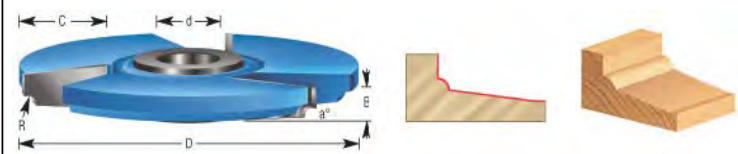

RAISED PANEL FOR 5/8" MATERIAL

Cove

ØD	B	C	R	a°	Ød	Rub Collar	Tool No.	Price
4-5/8	5/8	1-3/16	2-23/64	6°	1/2 & 3/4	C-005***	SC658	\$101.85
5-1/2	5/8	1-1/2	1-29/32	6°	1 & 1-1/4	C-017***	SC514	\$109.17

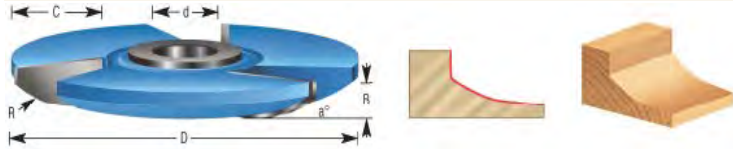

Classical

ØD	B	C	R	Ød	Rub Collar	Tool No.	Price
5	5/8	1-1/2	1/8	1/2 & 3/4	C-010***	SC690	\$83.97
5-1/2	5/8	1-1/2	1/8	1 & 1-1/4	C-017***	SC524	\$90.97

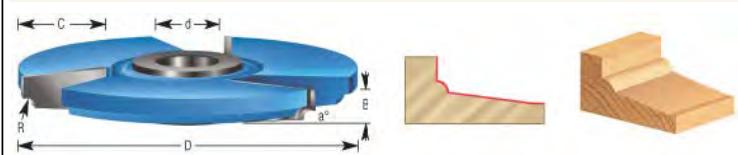

Traditional

ØD	B	C	a°	Ød	Rub Collar	Tool No.	Price
5-1/2	5/8	1-1/2	12°	1 & 1-1/4	C-017***	SC516	\$112.53
4-5/8	5/8	1-3/16	15°	1/2 & 3/4	C-005***	SC652	\$101.85

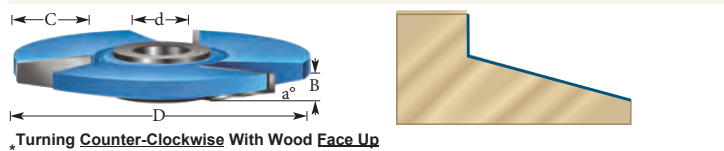

Classical

ØD	B	C	R	Ød	Rub Collar	Tool No.	Price
5-1/2	5/8	1-1/2	9/64	1 & 1-1/4	C-017***	SC526	\$94.74

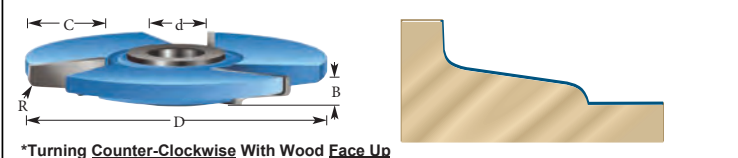

3D renderings & tool illustrations not shown at actual size.

AMANA

RAISED PANEL FOR 5/8" MATERIAL

Classical

ØD	B	C	R	a°	Ød	Rub Collar	Tool No.	Price
5	5/8	1-1/2	5/32	4°	1/2 & 3/4	C-010***	SC694	\$95.17
5-1/2	5/8	1-1/2	5/32	4°	1 & 1-1/4	C-017***	SC528	\$109.17

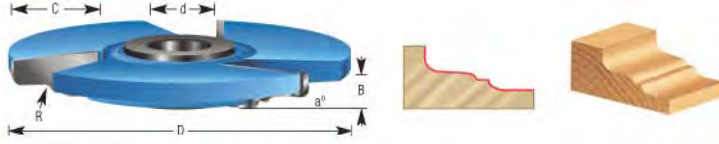

Ogee

ØD	B	C	R	R1	a°	Ød	Rub Collar	Tool No.	Price
5-1/2	5/8	1-1/2	1-5/16	1-15/16	28°	1 & 1-1/4	C-017***	SC530	\$104.97

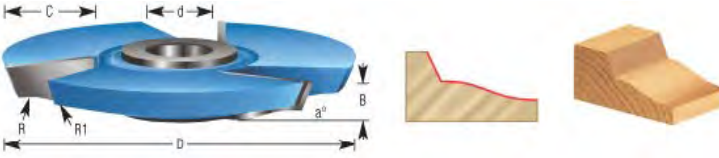

RAISED PANEL FOR 5/8" MATERIAL

Horizontal Panel Raising / Shear Face
Traditional

ØD	B	B1	R	C	a°	Ød	Rub Collar	Tool No.	Price
5-1/2	5/8	3/8	5/32	1-1/2	5°	1 & 1-1/4	C-017***	931	\$127.89

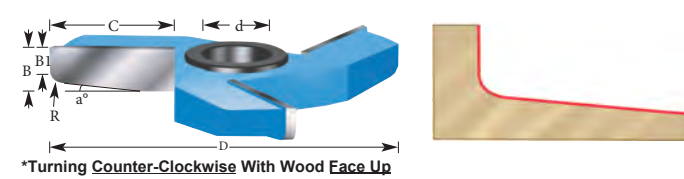

ØD	B	B1	C	a°	Ød	Rub Collar	Tool No.	Price
5-1/2	5/8	5/16	1-1/2	15°	1 & 1-1/4	C-017***	984	\$112.53
4-5/8	5/8	5/16	1-1/2	15°	1/2 & 3/4	C-005***	SC401	\$105.98



RAISED PANEL FOR 5/8" MATERIAL

Vertical Panel Raising / Shear Face
Traditional

ØD	B	B1	C	a°	Ød	Rub Collar	Tool No.	Price
3-1/2	5/8	5/16	1-5/8	15°	1/2 & 3/4	47822**	984-VC	\$93.17



3D renderings & tool illustrations not shown at actual size.

RAISED PANEL FOR 5/8" MATERIAL

Vertical Panel Raising / Shear Face
Cove

ØD	B	B1	R	C	Ød	Rub Collar	Tool No.	Price
3-1/2	5/8	1/4	1-9/16	1-5/8	1/2 & 3/4	47822**	987-VC	\$96.92

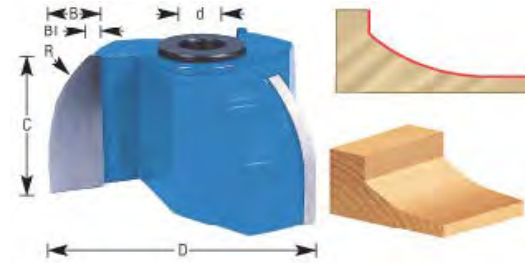

RAISED PANEL FOR 19/32" MATERIAL

Traditional

ØD	B	B1	R	C	a°	Ød	Rub Collar	Tool No.	Price
3-1/2	19/32	3/16	1/8	1-5/8	12°	1/2 & 3/4	C-016**	986-VC	\$102.03

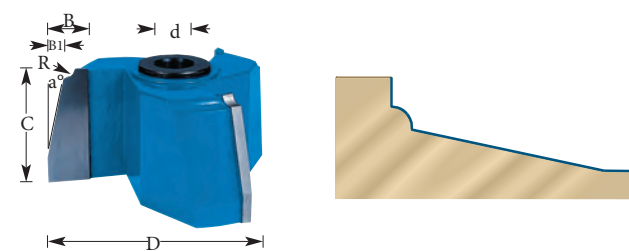

RAISED PANEL FOR 11/16" MATERIAL

Horizontal Panel Raising / Shear Face

Ogee

ØD	B	B1	R	C	Ød	Rub Collar	Tool No.	Price
5-1/2	11/16	9/32	3/4	1-1/2	1 & 1-1/4	C-017***	985	\$127.89
4-5/8	11/16	9/32	7/8	1-1/2	1/2 & 3/4	C-005***	SC403	\$108.26

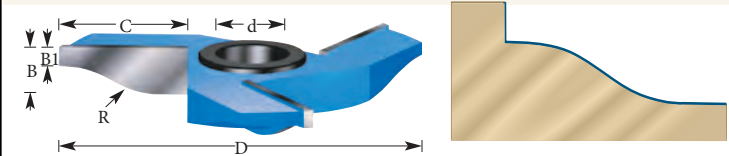

Classical

ØD	B	B1	R	C	a°	Ød	Rub Collar	Tool No.	Price
5-1/2	11/16	11/32	1/8	1-1/2	12°	1 & 1-1/4	C-017***	986	\$112.53
4-5/8	11/16	11/32	1/8	1-1/2	12°	1/2 & 3/4	C-005***	SC405	\$108.26

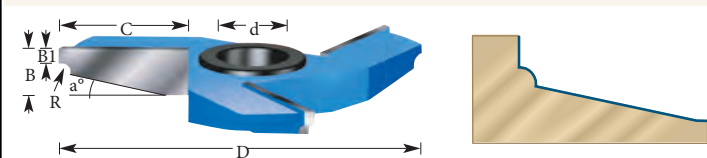

Cove

ØD	B	B1	R	C	Ød	Rub Collar	Tool No.	Price
5-1/2	11/16	1/4	1-9/16	1-1/2	1 & 1-1/4	C-017***	987	\$112.53
4-5/8	11/16	7/32	2-1/2	1-1/2	1/2 & 3/4	C-005***	SC407	\$108.26

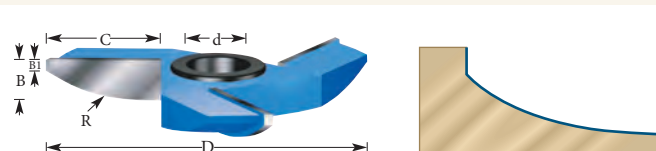

RAISED PANEL FOR 3/4" MATERIAL

Cove

ØD	B	R	Ød	Rub Collar	Tool No.	Price
4-15/16	11/16	1-57/64	1/2 & 3/4	C-004***	SC400	\$114.14
5-1/2	5/8	1-57/64	1 & 1-1/4	C-017***	SC500	\$117.04

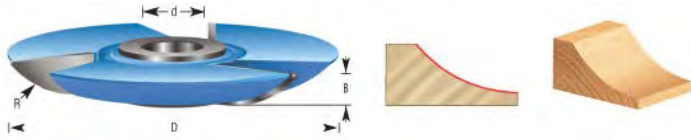

Ogee

ØD	B	C	R	R1	Ød	Rub Collar	Tool No.	Price
4-15/16	3/4	3/8	1-15/32	1/8	1/2 & 3/4	C-004***	SC402	\$109.73
5-1/2	5/8	5/16	1-15/32	1/8	1 & 1-1/4	C-017***	SC502	\$114.14

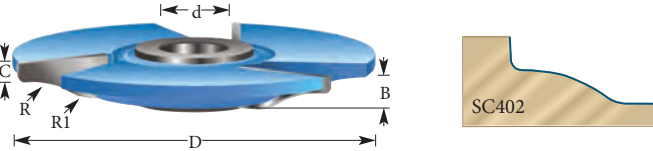

Traditional

ØD	B	C	a°	Ød	Rub Collar	Tool No.	Price
4-15/16	5/8	1/4	17°	1/2 & 3/4	C-004***	SC404	\$114.14
5-1/2	5/8	1/4	17°	1 & 1-1/4	C-017***	SC504	\$117.04

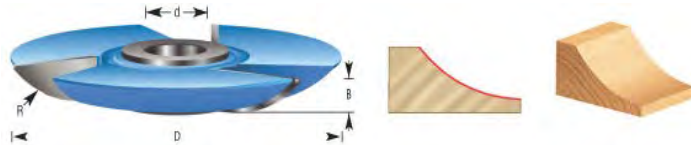

Traditional

ØD	B	R	a°	Ød	Rub Collar	Tool No.	Price
4-15/16	9/16	13/64	13°	1/2 & 3/4	C-004***	SC406	\$100.91
5-1/2	5/8	13/64	13°	1 & 1-1/4	C-017***	SC506	\$109.17

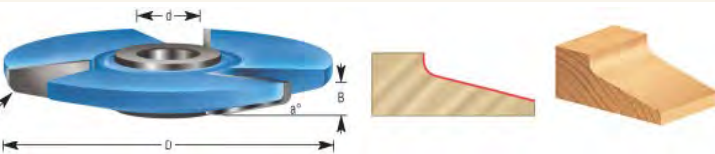

Ogee

ØD	B	C	a°	R	R1	Ød	Rub Collar	Tool No.	Price
4-15/16	11/16	3/8	23°	1-31/32	1-3/8	1/2 & 3/4	C-004***	SC408	\$94.61
4-15/16	5/8	5/16	23°	1-31/32	1-31/32	1 & 1-1/4	C-017***	SC508	\$101.89

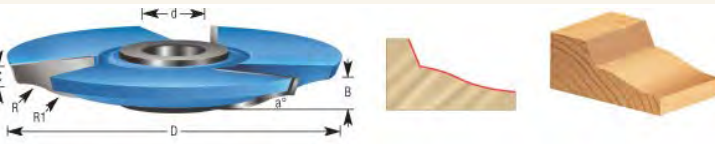

Classical

ØD	B	C	R	R1	Ød	Rub Collar	Tool No.	Price
5-1/2	5/8	3/8	13/64	1/8	1 & 1-1/4	C-017***	SC510	\$101.85

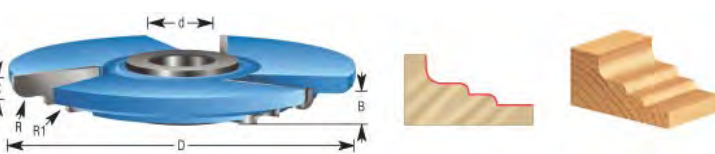

Classical

ØD	B	C	a°	R	Ød	Rub Collar	Tool No.	Price
5-1/2	5/8	1/4	10°	13/64	1 & 1-1/4	C-017***	SC512	\$109.17

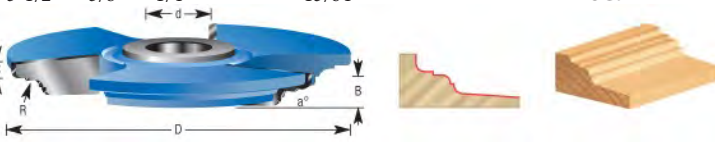

3D renderings & tool illustrations not shown at actual size.

Cove & Corner Round

ØD	B	C	R	R1	Ød	Rub Collar	Tool No.	Price
5-1/2	5/8	1/4	1/8	5/32	1 & 1-1/4	C-017***	SC509	\$109.17

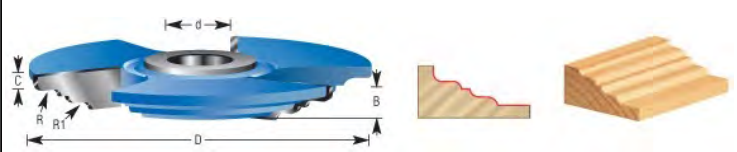

Cove & Corner Round

ØD	B	C	a°	R	Ød	Rub Collar	Tool No.	Price
5-1/2	5/8	1/4	4°	1/8	1 & 1-1/4	C-017***	SC511	\$109.17

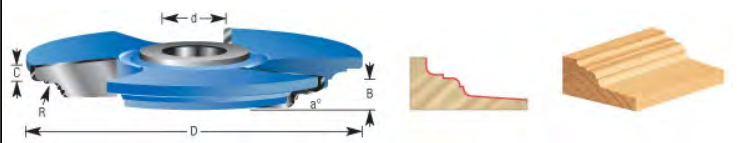

STEEL CUTTERHEADS

(For 40mm Knife System)

ØD	B	Ød	RPM Ideal/max.	Set No.	Price
100mm(4)	40mm(1-1/2)	1	5,800/9,000	61212	\$128.07
100mm(4)	40mm(1-1/2)	1-1/4	5,800/9,000	61220	\$120.61
120mm(4-3/4)	40mm(1-1/2)	1-1/4	5,100/7,900	61248	\$142.49

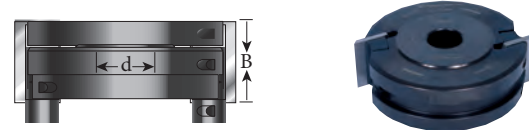

*Profile Pro™ black oxide solid steel cutterheads in **100mm or 120mm diameters.**

RABBETING

ØD	B	Teeth	Ød	Max. t	RPM	Repl. T.C.Knife	Tool No.	Price
100mm(4)	30mm(1-3/16)	2+4	1-1/4	20mm(7/8)	7,600-12,900	RCK-30 RCK-70	61460 *	\$131.05

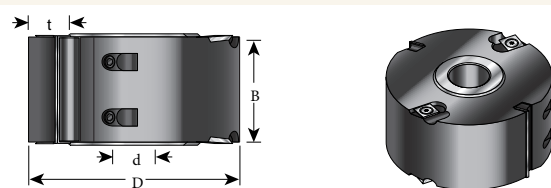

*Aluminum

PROFILE PRO™ SHAPER CUTTERS

ALUMINUM CUTTERHEADS

(For 40mm Knife System)

ØD	B	Ød	RPM Ideal/max.	Set No.	Price
88mm(3-1/2)	40mm(1-1/2)	1	7,000/9,000	61102	\$104.86
88mm(3-1/2)	40mm(1-1/2)	1-1/4	7,000/9,000	61104	\$124.46

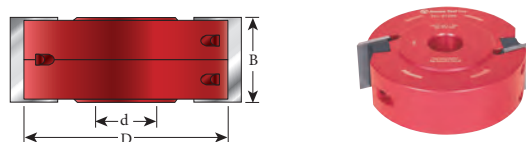

BALLEW SAW & TOOL

SHARPENING

Sharpening Prices for Shaper
Cutters Sets

ITEM	PRICE
2 Piece Door Lip Cutter Set	\$26.00
3 Piece Rail and Stile Door Set	\$31.00
4 Piece Rail and Stile Door Set	\$36.00
5 Piece Rail and Stile Door Set	\$45.00
6 Piece Rail and Stile Door Set	\$54.00
8 Piece Comb. Set for Exterior Doors	\$72.00

Make sure to send every piece even if you don't need them all sharpened. In order for us to sharpen your sets for optimum fit, we must have ALL of the pieces from the set.

Sharpening Prices for
Carbide-Tipped Dado Heads

ITEM	PRICE
Adjustable Dado Heads	\$12.50 each
Stack Type (up to 7 pieces)	\$45.00 each
Extra Chippers add	\$4.00 per chipper

Drawing indicates stackable type dado.
We do not sharpen steel stackable type dados.

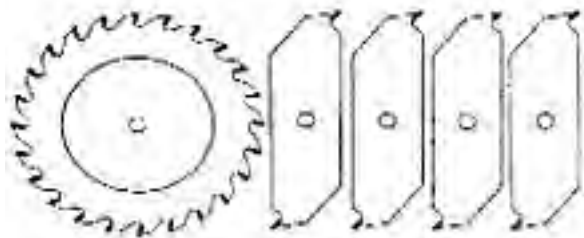
Sharpening Prices for
High Speed Steel, Carbide Jointer
and Planer Knives

ITEM	PRICE
High Speed Steel	\$0.60 per inch
Minimum	\$2.25 per knife
Carbide Knives	\$1.50 per inch
Minimum	\$5.50 per blade



Three Wing Cutters

Raised Panel, Door Edge, Straight Edge, Etc.

ITEM	PRICE
1 Cutter	\$16.00
2 Cutters	\$15.00 each
3 Cutters	\$14.00 each
4 Cutters	\$13.00 each
5 Cutters	\$12.00 each
6 Cutters	\$11.00 each
7 Cutters	\$10.00 each
8 Cutters	\$9.00 each

Oversized 3 wing cutters are subject to additional charges.

Router Bits

ITEM	PRICE
1-4 bits (1/4" and 1/2" shank)	\$4.95 each
5-8 bits (1/4" and 1/2" shank)	\$4.50 each
9 or more bits (1/4" and 1/2" shank)	\$4.25 each
Router bits with 1" diameter or larger	\$6.50 each
Raised Panel, Stile and Rail sets	\$9.00 each

Re-tipping router bits is possible but often costs more than a new router bit. Generally speaking, if only one wing on a two wing router bit is chipped or damaged, it should still work efficiently. Normally, however, a chipped or damaged tip is usually a sign for a new bit.

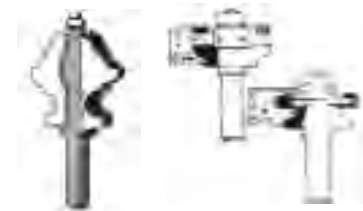
Sharpening Prices for High Speed
Steel Circular Metal Cutting Saw
Blades for Cutting Brass, Copper
and Aluminum

ITEM	PRICE
10" Diameter and smaller	\$11.00
12" - 14" Diameter	\$14.00
16" - 18" Diameter	\$18.00
20" - 22" Diameter	\$22.00

BALLEW SAW & TOOL

SHARPENING

Saw Blades

Carbide Tipped Saw Blades: We use the Industry Standard 10% Rule when it comes to chipped teeth. For example If you have a 60-tooth blade and 5 teeth have broken or chipped points, we will sharpen the blade and not replace any tips. This saves you money and will not noticeably affect the cut. If you do want every tooth fixed, put a note in with your blades. We will be happy to replace as you request.



www.ballewsaw.com

15" AND SMALLER DIAMETER SAW BLADES		16"- 19" DIAMETER SAW BLADES	
# OF TEETH	PRICE	# OF TEETH	PRICE
20 or less	\$8.50	20 or less	\$13.50
22-30	\$10.50	22-30	\$15.50
32-40	\$13.50	32-40	\$18.50
42-50	\$15.50	42-50	\$20.50
52-60	\$16.50	52-60	\$21.50
62-70	\$17.50	62-70	\$22.50
72-80	\$18.50	72-80	\$23.50
82-90	\$21.50	82-90	\$26.50
92-100	\$22.50	92-100	\$27.50
102-110	\$23.50	102-110	\$28.50
112-120	\$26.50	112-120	\$31.50
122-130	\$27.50	122-130	\$32.50
132-140	\$29.50	132-140	\$34.50

20" - 28" DIAMETER SAW BLADES	
# OF TEETH	PRICE
Any	\$39.00

30" MAXIMUM DIAMETER SAW BLADES	
# OF TEETH	PRICE
Any	\$49.00

IMPORTANT INFORMATION ABOUT SHARPENING YOUR TOOLS WITH US.

Please be sure to carefully and individually wrap each item you send to us to prevent damage during shipping.

If you need to sharpen a tool that comes from a set, be sure to send all of the pieces in so that we can ensure that the set works at its most optimum level.

If your sharpening order is **\$200.00** or more, we pay your return freight.* No freight paid on wooden or metal containers

If you want your order returned C.O.D add **\$20.00**.

*See the inside front cover of the catalog for more information.



CARBIDE TIP REPLACEMENT	PRICE
Standard Si e (3/16" kerf or less)	\$3.00 each
Above 3/16" kerf	Quote upon request
Outside Dado Blades	\$3.00 each
Dado Chippers	\$3.00 per tip

Always add sharpening cost to the above prices for replacements.

BALLEW SAW & TOOL

Custom Knife Pricing			
FINISHED LENGTH	ONE KNIFE	TWO KNIVES	THREE KNIVES
2" and smaller	\$39.00	\$78.00	\$117.00
2-1/2"	\$48.75	\$97.50	\$146.25
3"	\$58.50	\$117.00	\$175.50
3-1/2"	\$68.25	\$136.50	\$204.75
4"	\$78.00	\$156.00	\$234.00
4-1/2"	\$87.75	\$175.50	\$263.25
5"	\$97.50	\$195.00	\$292.50
5-1/2"	\$107.25	\$214.50	\$321.75
6"	\$117.00	\$234.00	\$351.00
6-1/2" and larger	Call For Pricing		

Corrugated Heads

These heads are machined from solid steel to accept 1/4" or 5/16" corrugated back knives. 20° hook and 60° corrugations with pocket style gibs which are included in each pocket.



3" DIAMETER
3/4" BORE - 2 KNIFE SLOTS

PART	HEIGHT	PRICE
BT31	1"	\$84.00
BT32	2"	\$102.00
BT33	3"	\$124.00

3-1/2" DIAMETER
1" BORE - 2 KNIFE SLOTS

PART	HEIGHT	PRICE
BT351	1"	\$90.00
BT352	2"	\$114.00
BT353	3"	\$140.00
BT354	4"	\$166.00

4" DIAMETER
1-1/4" BORE - 2 KNIFE SLOTS

PART	HEIGHT	PRICE
BT42-2	2"	\$118.00
BT43-2	3"	\$145.00
BT44-2	4"	\$165.00
BT45-2	5"	\$196.00
BT46-2	6"	\$216.00

4" DIAMETER
1-1/4" BORE - 4 KNIFE SLOTS

PART	HEIGHT	PRICE
BT42	2"	\$160.00
BT43	3"	\$196.00
BT44	4"	\$226.00
BT45	5"	\$268.00
BT46	6"	\$298.00

All Corrugated Heads are in Stock!

Other Pricing

Templates are \$25.00.

Weights and Gibs are \$20.00.

One (1) Set of Weights and Gibs matched to a single knife.
Contains one (1) Aluminum Gib for 5/16" knife, two (2) Steel Gibs, and two (2) Steel Counter Weights.

Filler Stock is \$5.00 per inch. Filler is required when the knife is a lot shorter than the head.

Aluminum or Steel Gibs are \$5.00.

Gibs balanced with the knife for custom molding Head are \$10.00.

Special Requests may include additional costs, called "set-up fees", if additional time or material is needed to complete your order.

Standard Manufacturing takes
3-5 business days.

Expediting Service Available.

Bosch

T-Shank Jig Saws Blades

Order #	Type	Applicatoin	Teeth Per Inch	Length	Tooth Design	Working Length	Type of Cut	Price
T101A	Special for Plexiglas	Plexiglas 5/64" - 3/4"	14 Teeth	4"	Ground teeth and taper ground back	2-3/4"	Fine and straight cuts	\$ 16.03
T101AO	Clean for Wood	Double-sided laminates, laminated particle board, MDF, hard/soft woods, plywood 5/64" 3/4"	20 Teeth	3.25"	Pointed teeth and ground	2-5/16"	Curved cuts and splinter free on both sides of the surface	\$ 7.03
T101AOF	Special for Laminate	Laminate flooring	20 Teeth	3.25"	Pointed teeth and ground	2-5/16"	Scroll blade for curved, splinter free cuts.	\$ 15.15
T101B	Clean for Wood	Hard/soft woods, plastics, OSB, plywood, laminated particle board 3/16"-1-1/4"	10 Teeth	4"	Ground teeth and taper ground back	3"	Straight, fine cuts	\$ 9.03
T101B100	See T101B for specification. Package quantity is 100 pieces.							\$145.10
T101BR	Clean for Wood	Hard/soft woods, plastics, OSB, plywood, laminated particle board 3/16" - 1-1/4"	10 Teeth	4"	Ground teeth and taper ground back	3"	Reverse tooth, splinter-free cuts on top of surface	\$ 10.12
T101BR100	See T101BR for specification. Package quantity is 100 pieces.							\$161.94
T101D	Clean for Wood	Hard/soft woods, plywood, OSB, plastics 1/4" - 2-3/8"	5-6 Progressive Teeth	4"	Ground teeth and taper ground back	3"	Straight, clean cuts	\$ 9.03
T101D100	See T101D for specification. Package quantity is 100 pieces.							\$145.10
T101DP	Precision for Wood	Hard/soft woods, plywood, particle board and plastics 1/4" 2-3/8"	6 Teeth	4"	Ground teeth and taper ground back	2-3/4"	Precise right angle cuts	\$ 10.64
T111C	Basic for Wood	Softwood, OSB, plywood 7/32" 2-3/8"	8 Teeth	4"	Side set and milled	3"	Fast, coarse cuts. Ideal for jig saws without orbital action	\$ 6.05
T111CF	Accurate for Wood with Nails	Wood with nails, OSB, plastic 3/16" - 1-1/4"	8 Teeth	4"	Side set and milled	3"	Straight cuts	\$ 12.90
T113A3	Special for Soft Materials	Cardboard, leathers, carpet, polystyrene and other soft materials	Knife Edge for Soft Materials	3"	Ground	3"	Fast, coarse cuts	\$ 11.17
T118A	Basic for Metal	Sheet metal 10-16 gauge, thin metals 1/16" - 1/8" (ferrous and non-ferrous)	17-24 Progressive Teeth	3.625"	Wavy set and milled	2-5/8"	Straight cuts	\$ 8.29
T118AF	Flexible for Metal	Sheet metal 10-16 gauge, thin metals 1/16" - 1/8" (ferrous and non-ferrous)	17-24 Progressive Teeth	3.625"	Wavy set and milled	2-5/8"	Straight cuts and long life	\$ 12.26
T118AF100	See T118AF for specification. Package quantity is 100 pieces.							\$195.58
T118AHM	Special for Stainless Steel	Stainless steel 3/64" - 5/64", steel and non-ferrous metals 1/16" - 1/8"	24 Teeth	3.25"	N/A	2-5/16"	Straight cuts and long life	\$ 30.59
T118B	Basic for Metal	Medium-thin metals 1/8" - 1/4" (ferrous and non-ferrous)	11-14 Progressive Teeth	3.625"	Wavy set and milled	2-5/8"	Straight cuts	\$ 8.29
T118G	Basic for Metal	Sheet metal 17-26 gauge, very thin metals 1/64"-3/64" (ferrous and non-ferrous)	36 Teeth	3.625"	Wavy set and milled	2-5/8"	Straight cuts	\$ 8.29
T118BF	Basic for Metal	Straight cuts & long life in medium-thin metals 1/8"-1/4" (ferrous and non-ferrous)	11-14 Progressive Teeth	3.625"	Wavy set and milled	2-5/8"	Straight cuts	\$ 12.26
T118EHM	Special for Stainless Steel	Stainless steel 5/64" - 3/16", steel and non-ferrous metals 5/64" - 7/32"	14 Teeth	3.25"	N/A	2-5/16"	Straight cuts and long life	\$ 30.59
T119BO	Basic for Wood	Softwood, OSB, plywood 5/64" 1/4"	12 Teeth	2.1875"	Side set and ground	2-3/16"	Scroll blade for curved cuts	\$ 7.72
T123X	Progressor for Metal	Thin metal, pipes and metal profiles, sheet metal up to 8 gauge, metal 5/64"-3/8", stainless steel 1/16"-1/8", non-ferrous metal 5/64"-3/4", plastics 1/16"-1-1/4", fiberglass 3/64"-3/4"	10-24 Progressive	4"	Side set and ground	3"	Fast cuts and long life	\$ 11.44
T123X3	See T123X for specification. Package quantity is 100 pieces.							\$ 7.62
T127D	Special for Aluminum	Aluminum 3/16" - 5/8", fiberglass 3/16" - 3/4", plastic 3/16" - 1-1/4"	8 Teeth	4"	Side set and ground	3"	Fast, straight cuts	\$ 10.01
T127D100	See T127D for specification. Package quantity is 100 pieces.							\$159.84
T127DF	Flexible for Aluminum	Aluminum 3/16" - 5/8", fiberglass 3/16" - 3/4", plastic 3/16" - 1-1/4"	8 Teeth	4"	Side set and ground	3-5/8"	Fast, straight cuts and long life	\$ 13.46

Bosch

T-Shank Jig Saws Blades

Order #	Type	Applicatoin	Teeth Per Inch	Length	Tooth Design	Working Length	Type of Cut	Price
T130RF3	Special for Ceramics	Ceramics, glass, fiberglass 3/64" - 5/8"	30 Grit	2.3125"	Coated	2-5/16"	File effect for fine, straight or curved cuts	\$ 19.99
T144D	Speed for Wood	Hard/soft woods, OSB, plywood 1/4" - 2-3/8"	5-6 Progressive Teeth	4"	Side set and ground	3"	Straight and very fast cuts	\$ 9.23
T144D100	See T144D for specification. Package quantity is 100 pieces.							\$147.21
T144DF	Speed for Hardwood	Hard/soft woods, OSB, plywood, wood with nails 1/4" - 2-3/8"	5-6 Progressive Teeth	4"	Side set and ground	2-3/4"	Straight, very fast cuts with long life	\$ 15.15
T150RF3	Special for Ceramics	Ceramics, glass, fiberglass 3/64" - 3/8"	50 Teeth	3.25"	Coated	2-5/16"	File effect for fine, straight or curved cuts	\$ 19.99
T211HF	Accurate for Wood with Nails	Wood with nails, plastic 1/8" - 1-1/4", non-ferrous metal and aluminum 1/8" - 1/2"	8 Teeth	3"	Side set and milled	2"	Scroll blade for curved cuts	\$ 14.14
T218A	Basic for Metal	Sheet metal 10-16 gauge, thin metals 1/16" - 1/8" (ferrous and non-ferrous)	17-24 Progressive Teeth	3.625"	Wavy set and milled	2-5/8"	Curved cuts	\$ 9.51
T227D	Special for Aluminum	Aluminum 3/16" - 5/8", fiberglass 3/16" - 3/4", plastic 3/16" - 1-1/4"	8 Teeth	4.25"	Side set and milled	3"	Fast, curved cuts	\$ 10.96
T234X	Progressor for Wood	Thick/thin, hard/soft woods including laminated particle board, OSB, plywood and particle board	8-12 Progressive Teeth	4.5"	Ground teeth and taper ground back	3-17/32"	Straight, accurate, splinter free cuts	\$ 10.71
T234X3	See T234X for specification. Package quantity is 3 pieces.							\$ 7.05
T244D	Speed for Wood	Hard/soft woods, OSB, plywood 1/4" - 2-3/8"	5-6 Progressive Teeth	4"	Side set and ground	3"	Scroll blade for curved and fast cuts	\$ 9.91
T244D100	See T244D for specification. Package quantity is 100 pieces.							\$157.72
T301CD	Clean for Wood	Hard/soft woods, plywood, laminated particle board 3/16"-2-3/8" and plastics 3/16"-1-1/4"	8 Teeth	4.625"	Ground teeth and taper ground back	3-5/8"	Straight, medium-fine cuts	\$ 15.80
T301CHM3	Special for Solid Surface	Solid surface materials 3/16" - 2-1/2"	8 Teeth	3.5"	N/A	3-1/2"	Fast, clean cuts	\$ 45.86
T301DL	Clean for Wood	Hard/soft woods, OSB, plywood, plastics 1/4"-3-3/8"	8 Teeth	5"	Ground teeth and taper ground back	4-1/8"	Straight, clean cuts	\$ 14.45
T308B	Xtra-Clean for Wood	Wood, laminated particle board and MDF	12 Teeth	4.5"	Ground teeth and taper ground back	3-1/2"	Straight, tear-free cuts on both top and bottom of workpiece	\$ 11.99
T313AW3	Special for Soft Materials	Cardboard, leathers, carpet, polystyrene and other soft materials	Knife Edge	6"	Ground	5"	Fast, coarse cuts	\$ 10.06
T318A	Basic for Metal	Pipes, profiles and sheet metal 10-16 gauge, thin metals 1/16" - 1/8" (ferrous and non-ferrous), pipes less than 2-1/2" diameter, tube stock, angle iron	24 Teeth	5.25"	Wavy set and milled	4-7/64"	Straight cuts	\$ 14.68
T318B	Basic for Metal	Pipes, profiles and sheet metal, medium-thin metals 5/64"-5/16" (ferrous and non-ferrous), pipes, profile diameters 5/64"-3-1/8"	14 Teeth	5.25"	Wavy set and milled	4-1/4"	Straight cuts	\$ 14.68
T344D	Speed for Wood	Hard/soft woods up to 4"	6 Teeth	5"	Side set and ground	5"	Straight and very fast cuts	\$ 15.88
T344DF	Speed for Hardwood	Hard/soft woods, OSB, plywood, wood with nails 1/4"-4"	6 Teeth	5"	Side set and ground	5"	Straight, very fast cuts with long life	\$ 38.10
T345XF	Progressor for All Purpose	Thick and thin materials like wood with nails, plywood, particle board 3/16"-3-5/8", metal 3/16"-3/8", non-ferrous metal and aluminum 5/64"-1-1/4"	5-10 Progressive Teeth	4.25"	Side set and milled	4-1/4"	Progressive tooth design for fast cuts and longer life	\$ 16.17
T345XF3	See T345XF for specification. Package quantity is 3 pieces.							\$ 10.78
T744D	Speed for Wood	Hard/soft woods up to 5-5/16"	6 Teeth	6"	Side set and ground	6"	Straight and very fast cuts	\$ 19.12
T500	(1) T101B, (1) T144D, (1) T119BO, (1) T118A, (1) T118B							\$ 8.52
T567A3	(1) T123X, (1) T234X, (1) T345XF							\$ 7.66
T5002	(2) T101B, (2) T144D, (2) T119BO, (2) T118A, (2) T118B							\$ 14.32

Bosch

U-Shank Jig Saws Blades

Order #	Type	Applicatoin	Teeth Per Inch	Length	Tooth Design	Working Length	Type of Cut	Price
U19BO	Basic for wood	Narrow, curve cuts in hard and soft wood, plywood, particleboard and plastics, 5/64"-3/4"	12 Teeth	2-3/4"	Wavy set and milled	2"	Rough, Curved cuts	\$ 5.07
U101B	Clean for Wood	Hard/soft woods, plastics, OSB, plywood, laminated particle board 3/16" - 1-1/4"	10 Variable Gullet Teeth	3.625"	Ground teeth and taper ground back	3"	Straight, fine cuts	\$ 8.92
U101BF	Clean for Hardwood	Long life in hard/soft woods, plastics, plywood, laminated particle board 3/16"-1-1/4"	6 Teeth	4"	Ground teeth and taper ground back	3-3/16"	Straight, fine cuts	\$12.82
U101D	Clean for Wood	Hard/soft woods, plywood, OSB, plastics 1/4" - 2-3/8"	5-6 Progressive Teeth	3.625"	Ground teeth and taper ground back	3"	Straight, clean cuts	\$ 8.92
U111D	Clean for Wood	Softwood (5-65 mm), chipboards, wood core plywood, fibre boards.	6 Teeth	3.5"	Side set and milled	3"	Straight cuts	\$ 6.92
U111DF	Clean for Hardwood	Long life in wood with nails, OSB, plastic 1/4"-2-3/8"	6 Teeth	3.1875"	Side set and milled	3-3/16"	Straight cuts	\$ 9.80
U111HF	Accurate for Wood with Nails	Wood with nails, plastic 1/8" - 1-1/4", non-ferrous metal and aluminum 1/8" - 1/2", metal 1/8" - 1/4"	10 Teeth	4"	Side set and ground	3-3/16"	Straight cuts	\$ 9.80
U118BF	Flexible for Metal	Medium-thin metals 1/8" - 1/4" (ferrous and non-ferrous)	11-14 Progressive Teeth	2.5"	Wavy set and milled	2-1/2"	Straight cuts and long life	\$ 8.96
U118E	Basic for Metal	Medium-thin metals 5/64" - 7/32" (ferrous and non-ferrous)	14-18 Teeth	3.125"	Wavy set and milled	2-1/2"	Straight cuts	\$ 6.60
U118EF	Flexible for Metal	Medium-thin metals 5/64" - 7/32" (ferrous and non-ferrous)	10-14 Teeth	3.125"	Wavy set and milled	2-1/2"	Straight cuts and long life	\$ 8.73
U118G	Basic for Metal	Sheet metal 17-26 gauge, very thin metals 1/64"-3/64" (ferrous and non-ferrous)	36 Teeth	2.75"	Wavy set and milled	2"	Straight cuts	\$ 6.60
U118GF	Flexible for Metal	Sheet metal 17-26 gauge, very thin metals 1/64"-3/64" (ferrous and non-ferrous)	36 Teeth	2.75"	Wavy set and milled	2"	Straight cuts and long life	\$ 8.73
U123X3	Progressor for Metal	Sheet metal up to 8 gauge, metal 5/64" - 3/8", stainless steel 1/16" - 1 1/4", fiberglass 3/64" - 3/4".	10-24 Teeth	3.625"	Side set and ground	3"	Fast cuts and long life	\$10.89
U144DF	Speed for Hardwood	Hard/soft woods, OSB, plywood, wood with nails 1/4" - 2-3/8"	5-6 Teeth	4"	Side set and ground	3-3/16"	Straight and very fast cuts	\$11.57
U345XF3	Progressor for All Purpose	Thick and thin materials like wood with nails, plywood, particle board 3/16"-3-5/8", metal 3/16"-3/8", non-ferrouse metal, aluminum 5/64"-1-1/4"	5-10 Progressive Teeth	4.21875"	Side set and milled	4-7/32"	Fast cuts and long life	\$ 9.58
U567A3	(1) U123X, (1) U234X, (1) U345XF							\$ 7.14

Bosch

Other Jig Saws

Order #	Applicatoin	Teeth Per Inch	Length	Kerf	Price
RDN6V	Variable 5/8 tooth pitch ideal for heavy demolition work in wood with nails, but strong enough to handle thick metals and other	5/8 Variable Teeth	6.0"	0.062"	\$ 17.12
RCFP66-2	Cement board, fiber board and plaster board	6 Teeth	6.0"	0.039"	\$ 21.94
RPRM6	Thick metal (1/8"-1/2")	8-14 Teeth	6.0"	0.05"	\$ 13.82
RCTM6X2	Wood, PVC/plastics and metal (1/16"-1/8")	14-18 Teeth	6.0"	0.042"	\$ 13.82
FS200ABF	Wood / PVC / non-ferrous metal	20 Teeth	7.875"		\$ 19.32
FS200ABU	Wood / PVC	20 Teeth	7.875"		\$ 19.32
FS180ATU	Wood / PVC / plastic	20 Teeth	5.75"		\$ 15.49

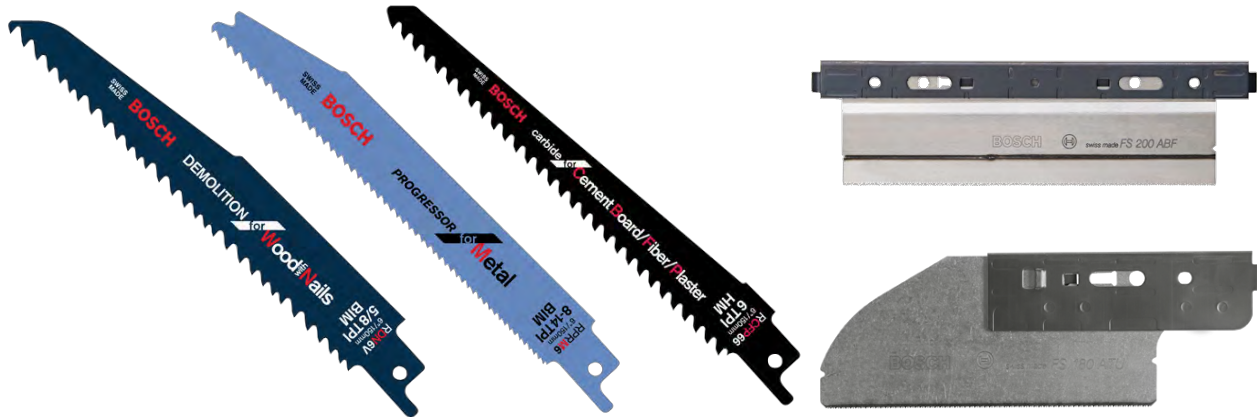

Order #	Diameter	Flute Length	Length	Shank Diameter	Price
DSB1002	5/16"	3"	6"	1/4"	\$ 2.18
DSB1004	7/16"	3"	6"	1/4"	\$ 2.26
DSB1010	13/16"	3"	6"	1/4"	\$ 2.66



BOSCH Straight/Mortising Router Bits

Solid Carbide Double-Flute Straight Bits

Micrograin bits provide exceptional smoothness of cut and balanced cutting with minimal vibration. Positive hook angles cut efficiently, and specially designed tips allow for fast plunge cutting. Strong webbing and heavy cutter backing provide superior bit life.

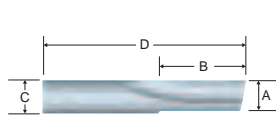

Item #	A. Overall Diameter	B. Cutting Edge Length	C. Shank Diameter	D. Overall Length	Price
85213M	1/8"	7/16"	1/4"	2"	\$15.46
85214M	3/16"	7/16"	1/4"	2"	\$16.26
85617M	1/4"	1"	1/4"	2-7/8"	\$23.91

Carbide-Tipped Plywood Mortising Bits

Micrograin bits designed with undersized cut diameters to match up to the actual thickness of 1/4", 1/2" and 3/4" plywood. Produce a tight fit when mortising standard plywood.

► 84600M is a solid carbide bit

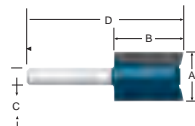

Item #	A. Overall Diameter	B. Cutting Edge Length	C. Shank Diameter	D. Overall Length	Application	Price
84600M	15/64"	3/4"	1/4"	2"	1/4" plywood	\$21.24

Carbide-Tipped Double-Flute Straight Bits

Micrograin bits designed to give excellent smoothness of cut and balanced cutting with minimal vibration. Positive hook angles cut efficiently while specially designed tips provide fast plunge cutting. Strong webbing and heavy cutter backing extend bit life.

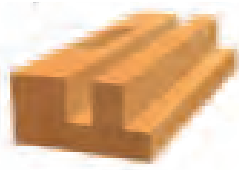
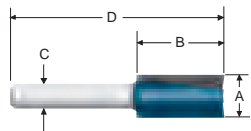

Item #	A. Overall Diameter	B. Cutting Edge Length	C. Shank Diameter	D. Overall Length	Price
85250M	1/4"	7/8"	1/4"	2-1/8"	\$16.82
85613M*	1/4"	1"	1/4"	2-1/4"	\$17.76
85459M*	1/4"	1"	1/4"	2-7/8"	\$16.70
85224M	5/16"	1"	1/4"	2-1/4"	\$16.47
85225M	3/8"	1"	1/4"	2-1/4"	\$16.28
85226M	7/16"	1"	1/4"	2-1/8"	\$18.28
85227M	1/2"	1"	1/4"	2-1/4"	\$17.65
85427M	1/2"	1"	1/2"	2-5/8"	\$17.98
85242M	1/2"	2"	1/2"	4-1/4"	\$19.03
85251M	1/2"	2-1/2"	1/2"	4-1/2"	\$21.80
85229M	9/16"	3/4"	1/4"	2-1/8"	\$18.01
85230M	5/8"	3/4"	1/4"	2"	\$17.98
85232M	3/4"	3/4"	1/4"	2"	\$19.06
85265M	3/4"	1-1/4"	1/2"	2-7/8"	\$19.82
85262M	13/16"	1-1/4"	1/2"	2-7/8"	\$19.89
85241M	3/8"	1"	1/2"	2-3/4"	\$16.84
85243M	1"	1-1/8"	1/2"	2-9/16"	\$24.59
85459M*	1/4"	1"	1/4"	2-7/8"	\$16.70

*Not guaranteed against breakage due to extreme length

Carbide-Tipped Single-Flute Straight Bits

Micrograin bits designed for roughing operations where high production feed rates are essential. Optimum chip clearance and specially designed tip allows for fast plunge cutting.

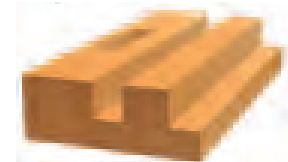
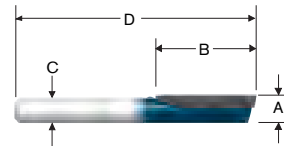

Item #	A. Overall Diameter	B. Cutting Edge Length	C. Shank Diameter	D. Overall Length	Price
85409M	3/8"	1"	1/4"	2-1/4"	\$16.15
85264M	1/2"	2"	1/2"	4-1/4"	\$19.72
85410M	1/4"	1"	1/4"	2-1/4"	\$13.23

Staggertooth Bits

Micrograin bits with staggered cutting flutes give two-flute balance with single-flute chip clearance for fast plunge cutting.

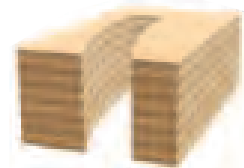
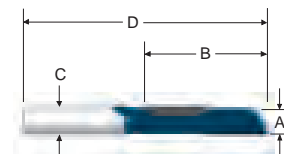

Item #	A. Overall Diameter	B. Cutting Edge Length	C. Shank Diameter	D. Overall Length	Price
85278M	1/2"	2-1/4"	1/2"	4-1/2"	\$24.41
85202M	1/2"	1-1/4"	1/2"	3-1/4"	\$16.37

BOSCH Spiral Router Bits

Solid Carbide Double-Flute Up Spirals

For use when material needs to be pulled in an upward motion toward the router motor, improving chip removal. Excellent when dust collection is required.

► Industrial/CNC bit for high-duty cycle applications

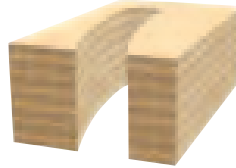
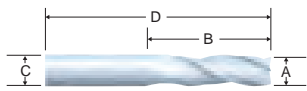

Item #	A. Overall Diameter	B. Cutting Edge Length	C. Shank Diameter	D. Overall Length	Price
85908M	1/8"	1/2"	1/4"	2"	\$18.77
85910M	1/4"	3/4"	1/4"	2-1/2"	\$18.77
85911M	1/4"	1"	1/4"	2-1/2"	\$23.52

Solid Carbide Triple-Flute Upcut Spirals

Bits work best on hard-to-route materials under reduced spindle speeds or horsepower. The upcut yields superior chip removal and a smooth finish.

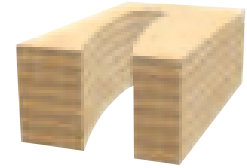
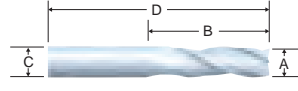

Item #	A. Overall Diameter	B. Cutting Edge Length	C. Shank Diameter	D. Overall Length	Price
85960M	1/2"	1-1/4"	1/2"	3"	\$39.99
85962M	1/2"	1-1/2"	1/2"	3-1/2"	\$49.99
85957M	5/16"	1"	1/2"	3"	\$39.99

Edge Forming Router Bits

Carbide-Tipped Ogee Bits with Fillet

Micrograin control-cut bits allow for three distinct cuts with one bit. Graceful lines of the ogee cut can be attractively accented with one or two fillets by lowering the depth setting or using 3/8" bearing (item 3600900501).

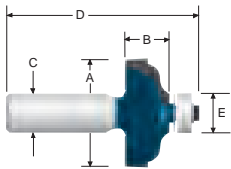

Item #	A. Overall Diameter	B. Cutting Edge Length	C. Shank Diameter	D. Overall Length	E. Bearing Diameter
85584M	1-3/8"	1/2"	1/4"	2-1/16"	1/2"

Part #	Price
85584M	\$47.05

Carbide-Tipped Chamfer Bits

Micrograin control-cut bits for beveling and decorative edging.

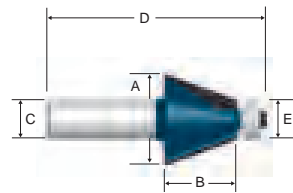

Item #	A. Overall Diameter	B. Cutting Edge Length	C. Shank Diameter	D. Overall Length	E. Bearing Diameter	Angle
85597M	1-1/4"	1/2"	1/2"	2-3/8"	3/8"	45°

Part #	Price
85597M	\$32.39

Carbide-Tipped Classical Bits

Micrograin control-cut bits that add classic beauty with decorative edging.

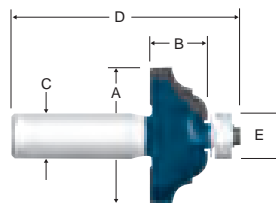

Item #	A. Overall Diameter	B. Cutting Edge Length	C. Shank Diameter	D. Overall Length	E. Radius
85579M	1-1/4"	1/2"	1/4"	2"	1/2"
85581M	1-1/2"	5/8"	1/4"	2-1/8"	1/2"
85582M	1-1/2"	5/8"	1/2"	2-1/2"	1/2"

Part #	Price
85579M	\$43.53
85581M	\$54.70
85582M	\$55.06

BOSCH

Edge Forming Router Bits

Carbide-Tipped Beading Bits

Micrograin control-cut bits used to create attractive, decorative edging. Items 84413M and 85493M are not control-cut bits.

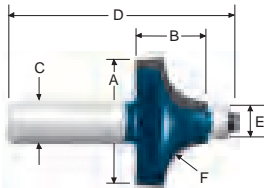

Item #	A. Overall Diameter	B. Cutting Edge Length	C. Shank Diameter	D. Overall Length	E. Bearing Diameter	F. Radius
85493M	7/8"	1/2"	1/4"	2"	3/8"	3/16"
85494M	1"	1/2"	1/4"	2"	3/8"	1/4"
85495M	1-1/8"	1/2"	1/4"	2-1/16"	3/8"	5/16"
85599M	1-1/4"	5/8"	1/2"	2-9/16"	3/8"	3/8"
85497M	1-1/2"	3/4"	1/4"	2-1/4"	3/8"	1/2"
85600M	1-1/2"	3/4"	1/2"	2-5/8"	3/8"	1/2"

Part #	Price
85493M	\$29.22
85494M	\$29.55
85495M	\$31.33
85599M	\$40.59
85597M	\$35.82
85600M	\$48.03

Carbide-Tipped Cove Bits

Micrograin control-cut bits for decorative edging and period furniture.

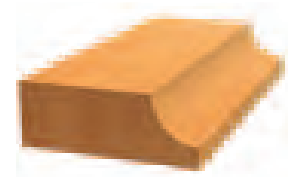
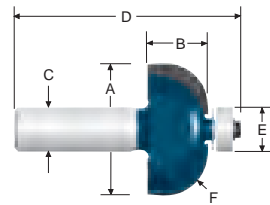

Item #	A. Overall Diameter	B. Cutting Edge Length	C. Shank Diameter	D. Overall Length	E. Bearing Diameter	F. Radius
85205M	7/8"	9/16"	1/4"	2"	3/8"	1/4"
85206M	1-1/8"	9/16"	1/4"	2"	3/8"	3/8"
85207M	1-3/8"	3/4"	1/4"	2-1/4"	1/2"	1/2"
84431M	1-3/8"	3/4"	1/2"	2-1/2"	3/8"	1/2"
84425M	7/8"	9/16"	1/2"	2-3/8"	1/2"	1/4"
84428M	1-1/8"	9/16"	1/2"	2-3/8"	1/2"	3/8"

Part #	Price
85205M	\$32.62
85206M	\$32.82
85207M	\$33.94
84431M	\$17.72
84425M	\$33.66
84428M	\$34.73

Carbide-Tipped Roundover Bits

Micrograin bits used for smooth, uniformly rounded edges. A lower depth setting produces a rounded corner with a decorative bead.

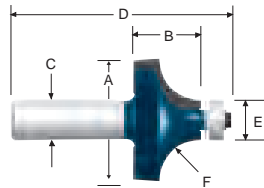

Item #	A. Overall Diameter	B. Cutting Edge Length	C. Shank Diameter	D. Overall Length	E. Bearing Diameter	F. Radius
85290M	3/4"	3/8"	1/4"	2"	1/2"	1/8"
84402M	7/8"	1/2"	1/2"	2-7/16"	1/2"	3/16"
85294M*	1"	1/2"	1/4"	2"	1/2"	1/4"
84405M*	1"	1/2"	1/2"	2-7/16"	1/2"	1/4"
85295M*	1-1/8"	1/2"	1/2"	2-7/16"	1/2"	5/16"
85296M*	1-1/4"	5/8"	1/4"	2-3/16"	1/2"	3/8"
85594M*	1-1/4"	5/8"	1/2"	2-9/16"	1/2"	3/8"
85297M*	1-1/2"	3/4"	1/4"	2-1/4"	1/2"	1/2"
85595M	1-1/2"	3/4"	1/2"	2-5/8"	1/2"	1/2"
85293M	7/8"	31/64"	1/4"	2-1/8"	1/2"	3/16"
85434M*	2"	1"	1/2"	2-7/8"	1/2"	3/4"

* Control-cut bit

Carbide-Tipped Multi Bead/Reeding Bits

Micrograin control-cut bits for creating classic triple beading with fillets in one pass.

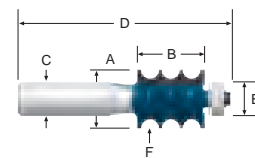

Item #	A. Overall Diameter	B. Cutting Edge Length	C. Shank Diameter	D. Overall Length	E. Bearing Diameter	F. Radius
84611M	7/8"	1"	1/2"	3"	16mm	1/8"

Part #	Price
85290M	\$31.46
85294M*	\$32.82
85295M*	\$33.37
85294M*	\$39.39
85295M	\$40.78
84402M	\$32.62
84405M*	\$33.66
85296M*	\$33.94
85297M*	\$34.53
85293M	\$32.32
84434M*	\$60.73

Part #	Price
84611M	\$21.13

BOSCH

Edge Forming Router Bits

Carbide-Tipped Cove and Bead Bits

Micrograin bits used to create an attractive accent with a classic woodworking design.

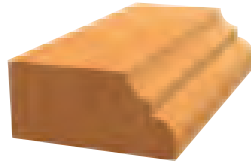
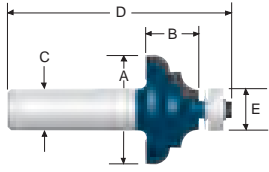

Item #	A. Overall Diameter	B. Cutting Edge Length	C. Shank Diameter	D. Overall Length	E. Radius
85604M	1-3/8"	11/16"	1/4"	2-3/16"	1/2"
85605M	1-3/8"	11/16"	1/2"	2-9/16"	1/2"
Part #	Price				
85604M	\$43.73				
85605M	\$44.94				

Carbide-Tipped Chair Mat Bit

Micrograin control-cut bit to cut out and edge-form chair mats and other items fabricated from softer plastic such as vinyl and acrylic in a single operation. Bit is designed to help minimize edge cracking in such materials and also is suitable for use with 1/4" and thinner wood and plywood.

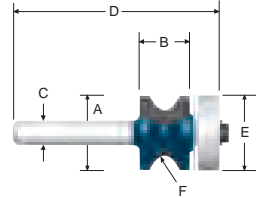

Item #	A. Overall Diameter	B. Cutting Edge Length	C. Shank Diameter	D. Overall Length	E. Bearing Diameter	F. Radius
85612M	47/64"	17/32"	1/4"	2-7/32"	47/62"	3/32"
Part #	Price					
85612M	\$25.32					

Carbide-Tipped Edge Beading Bits

Versatile micrograin bits used for adding attractive edging on new pieces and matching many older molding cuts for remodeling work.

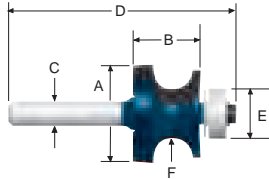

Item #	A. Overall Diameter	B. Cutting Edge Length	C. Shank Diameter	D. Overall Length	E. Bearing Diameter	F. Radius
85631M	7/8"	9/16"	1/4"	2-1/8"	1/2"	1/8"
85632M	7/8"	9/16"	1/2"	2-1/2"	1/2"	1/8"
85666M	1-1/8"	11/16"	1/4"	2-1/4"	16mm	3/16"
85668M	1-1/4"	3/4"	1/4"	2-1/4"	16mm	1/4"
85667M	1"	11/16"	1/2"	2-1/2"	1/2"	3/16"
Part #	Price					
85631M	\$35.82					
85632M	\$35.00					
85666M	\$33.94					
85668M	\$36.07					
85667M	\$35.06					

Carbide-Tipped Roman Ogee Bits

Micrograin control-cut bits used for decorative edging and period furniture.

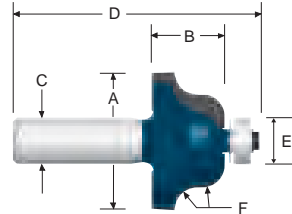

Item #	A. Overall Diameter	B. Cutting Edge Length	C. Shank Diameter	D. Overall Length	E. Bearing Diameter	F. Radius
85270M	1"	5/8"	1/4"	2-1/8"	1/2"	5/32"
85271M	1-3/8"	7/8"	1/4"	2-1/4"	1/2"	1/4"
85591M	1-1/8"	1/2"	1/2"	2-7/16"	1/2"	5/32"
85592M	1-1/4"	25/32"	1/2"	2-11/16"	1/2"	1/4"
Part #	Price					
85207M	\$36.07					
85271M	\$38.23					
85591M	\$41.17					
85592M	\$48.67					

Carbide-Tipped Wavy Edge Bits

Micrograin bits with a unique pattern to create soft, rounded corners.

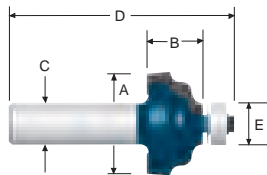

Item #	A. Overall Diameter	B. Cutting Edge Length	C. Shank Diameter	D. Overall Length	E. Bearing Diameter
85606M	1-1/4"	11/16"	1/4"	2-1/4"	1/2"
Part #	Price				
85606M	\$43.78				

BOSCH

Trimming/Cutout Router Bit

Solid Carbide Bevel-Trimmer Bits

Provides a 7-1/2° bevel on the trim edge of plastic laminate surfaces. The self-pilot eliminates guide assembly.

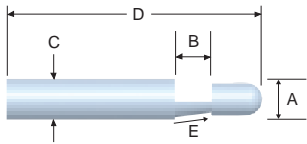

Item #	A. Overall Diameter	B. Cutting Edge Length	C. Shank Diameter	D. Overall Length	E. Angle	Quantity
85286	1/4"	1/4"	1/4"	1-1/2"	7-1/2°	1
Part #	Price					
85286M	\$9.13					

Carbide-Tipped Top Bearing-Mounted Straight/Trim Bits

Micrograin bits with top-mounted ball bearing ride against templet for pattern routing.

- Replacement collar 3600231500
- Replacement set screw 3603401506

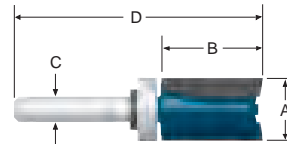

Item #	A. Overall Diameter	B. Cutting Edge Length	C. Shank Diameter	D. Overall Length
85680M	1/2"	1"	1/4"	2-1/2"
Part #	Price			
85680M	\$27.75			

Solid Carbide Flush-Trimmer Bits

Self-piloting bit makes flush, trim and edge cuts

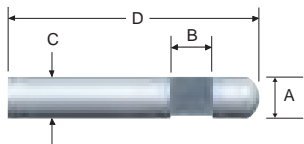

Item #	A. Overall Diameter	B. Cutting Edge Length	C. Shank Diameter	D. Overall Length	Quantity
85285	1/4"	1/4"	1/4"	1-1/2"	1
Part #	Price				
85285M	\$9.13				

Carbide-Tipped Double-Flute Laminate Trimmer Assemblies

Micrograin bits ideal for fast, accurate trim cuts.

- Shank replacement arbor 82808

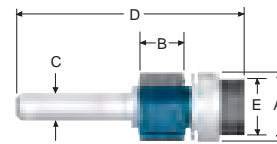

Item #	A. Overall Diameter	B. Cutting Edge Length	C. Shank Diameter	D. Overall Length	E. Bearing Diameter	Angle
85431M	5/8"	3/8"	1/4"	1-15/16"	5/8"	10°
85430M	5/8"	3/8"	1/4"	1-15/16"	5/8"	Flush
Part #	Price					
85431M	\$17.74					
85430M	\$18.83					

Carbide-Tipped Triple-Flute Laminate Flush Trimming Bits

Micrograin bit provides chatter-free production trimming with an extra smooth, flush-trim cut. Compact ball-bearing assembly is equipped with a glue shield.

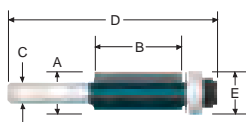

Item #	A. Overall Diameter	B. Cutting Edge Length	C. Shank Diameter	D. Overall Length	E. Bearing Diameter
85216M	1/2"	1"	1/4"	2-5/8"	1/2"
Part #	Price				
85216M	\$22.55				

Carbide-Tipped Triple-Flute Trimming Bit

Micrograin bit for laminate trimming and trim cuts on heavier work when cutting with a templet. Can be used with two ball bearings to widen the bearing surface and reduce templet wear.

- Extra ball bearing 2610906500

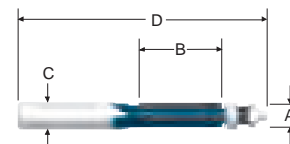

Item #	A. Overall Diameter	B. Cutting Edge Length	C. Shank Diameter	D. Overall Length
85602M	1/2"	1-1/2"	1/2"	4-1/2"
Part #	Price			
85602M	\$31.12			

BOSCH

Trimming/Cutout Router Bits

Carbide-Tipped Double-Flute Flush and Bevel Laminate Trimming Bits

Micrograin bits ideal for fast, smooth, accurate trim cuts with a shielded, compact ball-bearing pilot.

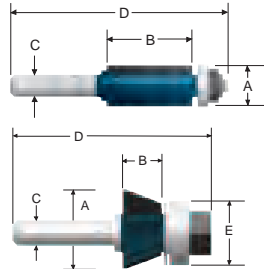

Item #	A. Overall Diameter	B. Cutting Edge Length	C. Shank Diameter	D. Overall Length	Type of Cut
85267M	1/2"	1/2"	1/4"	2-1/4"	Flush
85441M	1/2"	1"	1/2"	3-1/4"	Flush
85266M	1/2"	1"	1/4"	2-5/8"	Flush
85268M	3/8"	1"	1/4"	2-9/16"	Flush
85269M	3/8"	1/2"	1/4"	2-1/8"	Flush

Part #	Price
85267M	\$16.62
85441M	\$19.98
85266M	\$17.18
85268M	\$16.11
85269M	\$15.63

Carbide-Tipped Overhang Cutoff Bits

Micrograin bits for rough sizing of plastic laminates, prior to gluing, without scribing or sawing. Bit leaves a slight overhang and is ideal for tops with irregular shapes.

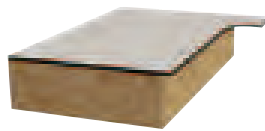
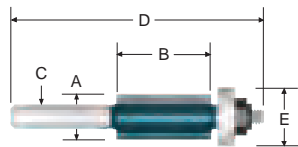

Item #	A. Overall Dia.	B. Cutting Edge Length	C. Shank Dia.	D. Overall Length	E. Bearing Dia.	Overhang
85217M*	11/32"	1/2"	1/4"	2-19/64"	3/4"	3/16"

* Single flute

Part #	Price
85217M*	\$23.91

Carbide-Tipped Double-Flute Template / Trimming Blade

Micrograin bit provides smooth cuts for laminate trimming, cutouts and pattern cutting. Comes with two ball bearings. Use two ball bearings to widen the bearing surface and reduce templet wear.

▶ Extra ball bearing 2610906500

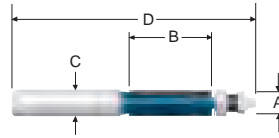

Item #	A. Overall Diameter	B. Cutting Edge Length	C. Shank Diameter	D. Overall Length
85601M	1/2"	1-1/2"	1/2"	4-3/8"
Part #	Price			
85601M	\$25.26			

Carbide-Tipped Helical Laminate Trimming Bits

Provide extra smooth production trimming.

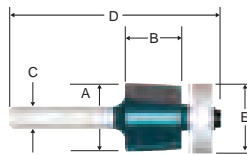

Item #	A. Overall Diameter	B. Cutting Edge Length	C. Shank Diameter	D. Overall Length	E. Bearing Diameter	Angle
85459M	3/4"	3/8"	1/4"	2"	3/4"	15°
Part #	Price					
85459M	\$16.70					

Pilot Panel Bits with Drill-Through Point—Single Flute

For window and door cutouts in abrasive insulation materials, plywood and paneling.

- ▶ Drill-through pilot for guiding on templet or framing after panel has been mounted
- ▶ The concave grind offers a faster cut over the straight grind pilot panel bits

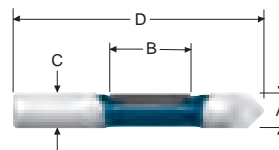

Item #	A. Cut Diameter	B. Flute Length	C. Shank Diameter	D. Overall Length	Qty.
Carbide-Tipped—Concave Flute					
85244M	1/4"	3/4"	1/4"	2-1/2"	1
85245M	3/8"	1"	3/8"	3"	1
85246M	1/2"	1-3/16"	1/2"	3-5/8"	1
Part #	Price				
85244M	\$12.62				
85245M	\$13.07				
85246M	\$14.50				

BOSCH

Cabinetry/Joinery Router Bits

Solid Carbide Veining Bits

Provincial design veining bits are intended for recessed design veining in fine cabinet surfaces and used extensively for door-front grooving.



Item #	A. Overall Diameter	B. Cutting Edge Length	C. Shank Diameter	D. Overall Length	E. Radius
85283	1/4"	25/64"	1/4"	1-1/2"	1/8"

Part #	Price
85283M	\$15.26

Carbide-Tipped Rabbeting Bits

Micrograin control-cut bits for making rabbeting cuts without the use of a router guide.

- ▶ To increase the width of rabbet by 1/16" for 85218M and 85590M, purchase 3/8" diameter bearing 3600900501 and dust shield 3600120507

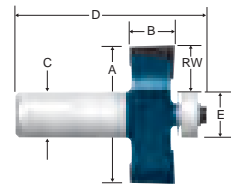

Item #	RW Rabbet Width	A. Overall Dia.	B. Cutting Edge Length	C. Shank Dia.	D. Overall Length	E. Bearing Dia.
85218M	3/8"	1-1/4"	1/2"	1/4"	2"	1/2"
85590M	3/8"	1-1/4"	1/2"	1/2"	2-3/8"	1/2"
85614M	1/2"	1-3/8"	1/2"	1/4"	2"	1/2"
85615M	1/2"	1-3/8"	1/2"	1/2"	2-3/8"	1/2"

Part #	Price
85218M	\$27.38
85590M	\$33.37
85614M	\$30.31
85615M	\$33.37

Carbide-Tipped Ogee Stile and Rail Bits

Micrograin bits with shear-angle geometry, super-sharp cutting edges and close-tolerance manufacturing to ensure consistently smooth, tight-fitting joints.

- ▶ These bits are not for use in hand-held routers. Use with a router table only. Designed for 3/4" wood with a maximum wood thickness of 7/8"
- ▶ Both 85626M and 85627M assemblies are reversible. Either can be used to make both stile and rail cuts by order on the arbor. This requires one workpiece to be cut face up and the other workpiece face down

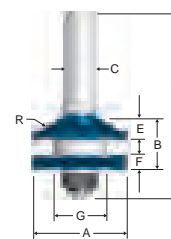
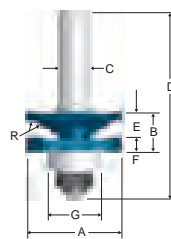

Item #	A. Overall Diameter	B. Cutting Edge Length	C. Shank Diameter	D. Overall Length	E. Decorative Cut Depth	F. Kerf	G. Bearing Diameter	R. Radius
85626M	1-5/8"	43/64"	1/2"	3"	13/32"	3"	7/8" (22mm)	1/2"
85627M	1-5/8"	51/64"	1/2"	3"	17/64"	3"	7/8" (22mm)	1/2"

Part #	Price
85626M	\$77.42
85627M	\$77.42

Carbide-Tipped Raised-Panel Cutters

Micrograin bits produce raised-panel cuts along straight and curved panel edges.

- ▶ These bits are not for use in hand-held routers. Use with a router table only
- ▶ Minimum recommended panel thickness is 3/4"

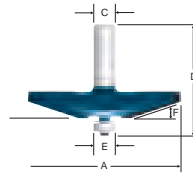

Item #	A. Overall Dia.	B. Cutting Edge Length	C. Shank Dia.	D. Overall Length	E. Bearing Dia.	F. Angle	Cutting Width
85637M	2-3/4"	5/8"	1/2"	2-17/32"	1/2"	26°	1-1/8"

Part #	Price
85637M	\$101.73

Carbide-Tipped Keyhole Bits

For plunge and slots cuts. Route mounting slots in picture frames and plaques.

- ▶ 85608M is a carbide tipped bit
- ▶ 85078 is a high-speed steel bit

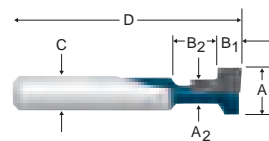

Item #	A1. Large Diameter	A2. Small Diameter	B. Cutting Edge	C. Shank Diameter	D. Overall Length
85608M	3/8"	3/16"	3/8"	1/4"	1-1/2"

Part #	Price
85608M	\$20.36

BOSCH

Surface Forming Router Bits

Carbide-Tipped Classical Bits

Micrograin bits are used for beautiful, decorative grooving, adding a quality accent to any project. Also recommended for edge forming with a router guide.

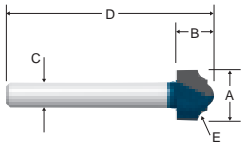

Item #	A. Overall Diameter	B. Cutting Edge Length	C. Shank Diameter	D. Overall Length	E. Bevel
85467M	1/2"	7/16"	1/4"	2"	3/32"
Part #	Price				
85467M	\$31.78				

Solid Carbide V-Groove and Scoring Bit

Excellent for door-front grooving and scoring panel design in wood. Produces simulated paneling for walls, doors and furniture.

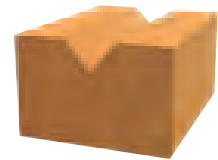
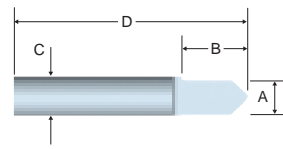

Item #	A. Overall Diameter	B. Cutting Edge Length	C. Shank Diameter	D. Overall Length	Bevel
85284M	1/4"	3/4"	1/4"	1-1/2"	41°
Part #	Price				
85284M	\$9.49				

Carbide-Tipped V-Groove and Scoring Bits

Micrograin bits ideal for door-front grooving, lettering and sign work. Features shear angle cutter geometry for smooth, efficient cutting.

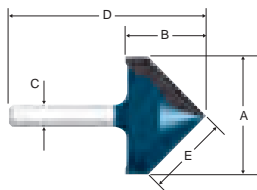

Item #	A. Overall Diameter	B. Cutting Edge Length	C. Shank Diameter	D. Overall Length	E. Bevel
84306M	3/4"	5/8"	1/2"	2-1/8"	3/8" (45°)
85219M	9/16"	3/4"	1/4"	1-3/4"	3/8" (45°)
85220M	1-1/4"	1"	1/4"	2-1/2"	7/8" (45°)
Part #	Price				
84306M	\$36.10				
85219M	\$20.25				
85220M	\$34.92				

Carbide-Tipped Core Box Bits

Micrograin bits for cutting rounded grooves used in a variety of applications including doors and columns.

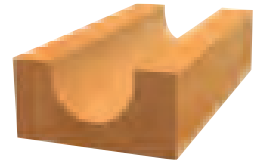
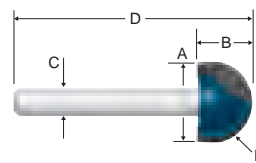

Item #	A. Overall Diameter	B. Cutting Edge Length	C. Shank Diameter	D. Overall Length	E. Bearing Diameter
85444M	1/4"	1/4"	1/4"	1-5/8"	1/8"
85445M	3/8"	1/4"	1/4"	1-1/2"	3/16"
85446M	1/2"	3/8"	1/4"	1-1/2"	1/4"
85448M	3/4"	1/2"	1/4"	2-1/8"	3/8"
Part #	Price				
85444M	\$19.26				
85445M	\$24.76				
85446M	\$25.46				
85448M	\$34.92				

Bosch Sanding Pads & Discs



Item #	Diamete	Description	Price
RS013	5"	Sponge applicator pad	\$8.38
RS014	5"	Buffing pad	\$7.97
SBPT01		Ball Bearing BOSCH Parts	\$4.95

Item #	Diamete	Used on Model No.	Price
RS030	5"	1295DP, 1295D, 1295DH, 1295DVS, 3107DVS, 3725DVS, 3725DEVS	\$14.11
RS031	5"	1295DP, 1295D, 1295DH, 1295DVS, 3107DVS, 3725DVS, 3725DEVS	\$14.11
RS032	5"	1295DP, 1295D, 1295DH, 1295DVS, 3107DVS, 3725DVS, 3725DEVS	\$14.11
RS034	5"	ROS10 and ROS20VS	\$13.57
RS6034	6"	1370DEVS	\$16.95
RS6041	6"	B7300	\$19.95
RS6043	6"	B7300	\$19.95
RS6044	6"	1250DEVS, 3727DEVS, ROS65VC	\$15.97
RS6045	6"	1250DEVS, 3727DEVS, ROS65VC	\$15.97
RS6046	6"	1250DEVS, 3727DEVS, ROS65VC	\$15.97
RSP019	5"	1295DP, 1295D, 1295DH, 1295DVS, 3107DVS, 3725DVS, 3725DEVS	\$10.54

Item #	Grit	Diameter	Quantity	Description	Price
SR5R080	80	5"	5	Hook and loop, 8 holes	\$3.23
SR6R320	320	6"	5	Hook and loop, 6 holes	\$3.66
ZR5B000	60*2, 120*2, 220*1	5"	5	Hook and loop, 8 holes	\$3.49
ZR5B080	80	5"	5	Hook and loop, 8 holes	\$3.49
RS060	60	5"	5	Hook and loop, 8 holes	\$4.97
RS1043	40	6"	10	Hook and loop, 8 holes	\$15.92
RS1083	80	6"	10	Hook and loop, 6 holes	\$11.85
RS1123	120	6"	10	Hook and loop, 8 holes	\$11.43
RS1183	180	6"	10	Hook and loop, 6 holes	\$10.98
RS120	120	5"	5	Hook and loop, 8 holes	\$4.13
RS180	180	5"	5	Hook and loop, 8 holes	\$3.96
RS240	240	5"	5	Hook and loop, 8 holes	\$4.13
RS320	320	5"	5	Hook and loop, 8 holes	\$3.96

BYRD TOOL



Heads - Journal Heads
Shaper Heads - Moulder Heads



Spiralled Stagger Tooth to break up chips for dust collection systems and to reduce horsepower requirements.

Shear to give clean cutting action. **Helix** to assist the chip flow.

Replacement Tips (sold in /Boxes of 10)

SHELIX REPLACEMENT TIPS (BOXES OF 10)		PRICE
10-290 (1-29 Boxes)	KN 400 - 1-29	\$31.50/box
300-990 (30-99 Boxes)	KN 400 - 30-99	\$28.80/box
1000 or more	KN 400 - 100+	\$25.20/box

Benefits to True Helical Cuts:

- Thicker Knives than most 2.5mm
- Chip clearance between knives
- Extremely quiet cuts
- Replace only damaged or dull knives
- More overlap row to row
- Radius ground on knives
- Greatly reduces tearout



10-32 TORX+ Screws for Shelix" start \$0.85 each

Jointers (Carbide Tips Included)

Item	Price
BRIDGEW OOD BW -16J 16"	\$ 1,129.50
DELTA DJ30 12" / ROBLAND - X31 OR 310	\$ 940.50
DELTA 37-220 6" (5/8" OR 9/16" SHAFT) / DELTA DJ-15 6"	\$ 323.10
DELTA 37-315 8" / GENERAL 480 8' / YORKCRAFT YC 8J 8"	\$ 422.10
FELDER AD-531 12" COMBO	\$ 1,008.00
FELDER AD-741 16" COMBO	\$ 1,264.50
FELDER HAM M ER A 3-26 10" COMBO	\$ 756.90
FELDER HAM M ER A 3-31 / HAM M ER 310 12" COMBO	\$ 869.40
FELDER HAM M ER A 3-41 16" COMBO	\$ 1,075.50
GEN 780 12" / S.A.C. FS/305 12" / INVICTA DI 32 12" / GEN 280	\$ 1,030.50
GENERIC 10"	\$ 670.50
GENERIC 12"	\$ 828.00
GENERIC 6"	\$ 323.10
GENERIC 8"	\$ 422.10
INVICTA DI 20 8" / DELTA DJ20 8" / GRIZZLY G-1018 8"	\$ 422.10
INVICTA DI 42 16" (DELTA RJ-42) / S.A.C. FS/430 16"	\$ 1,413.00
JET JJ8CS 8" / BRIDGEW OOD BW -8J 8" / STL CTY 40605 8"	\$ 422.10
JET JPT - 310 OR JJP 12 - 12" JOINTER-PLANER	\$ 1,035.00
KNAPP AD 410 PROFIT 16"	\$ 1,318.50
M INIM AX FS 35 14"	\$ 1,224.00
M INIM AX FS-41 16"	\$ 1,413.00
NORTHFIELD 12" - HD OR MD	\$ 1,224.00
NORTHFIELD 16" - HD OR MR	\$ 1,602.00
OLIVER 166 12"	\$ 1,489.50
OLIVER 166 16"	\$ 1,791.00
OLIVER 166 20"	\$ 2,083.50
OLIVER 166 24"	\$ 2,502.00
OLIVER 4240 10"	\$ 670.50
OLIVER 4255 / BW -12J / GRIZZLY G 9860 12" / STL CTY 40610 12"	\$ 828.00
OLIVER 4270 16"	\$ 1,129.50
POW ERM ATIC P 50 6" (5/8" OR 3/4" SHAFT) / P 54A 6"	\$ 323.10
POW ERM ATIC P 60 8" / PJ882 8" (5/8" OR 3/4" SHAFT)	\$ 422.10
S.A.C. FS/530 20"	\$ 1,597.50
SCM I 410 16"	\$ 1,413.00
SICAR 310 12" / GRIGGIO PF-330 12" / M INIM AX FS 30 12"	\$ 1,030.50
YORKCRAFT YC 67 6" / DELTA 37-195 6" / STL CTY 40615 6"	\$ 323.10

Planers (Carbide Tips Included)

Item	Price
BRIDGEWOOD BW-15P 15" 4-POST	\$ 751.50
BRIDGEWOOD BW-16-PV	\$ 1,129.50
BRIDGEWOOD BW-609 / GRIZZLY G9741 24"	\$ 1,602.00
BUSS 24"	\$ 3,870.00
BUSS MODEL 44 30"	\$ 5,476.50
BW-120P 20" / BW-200P 20" / BW-20-PV / BW-508 20"	\$ 1,224.00
BW-124P 24" / BW-240 24" / BW-240P 24"	\$ 1,507.50
CASDEI 20" - R51H3	\$ 2,736.00
DELTA 22-200/22-201 18" WEDGE BED PLANER	\$ 1,791.00
DELTA 22-470 24"	\$ 1,980.00
DELTA 22-503 24"	\$ 2,169.00
DELTA 22-580 / 22-590 / 22-595 W/BRGS	\$ 423.00
DELTA 22-660 13"	\$ 846.00
DELTA DC380 15"	\$ 751.50
DELTA DC-580 20"	\$ 1,318.50
DELTA/RC 22-650 13"	\$ 846.00
DEWALT DW-733 / DW-734 / DW-735 W/BRGS	\$ 423.00
EXTREMA 24"	\$ 1,507.50
GENERAL 130 14"	\$ 1,224.00
GENERIC 15" 4-POST	\$ 751.50
GENERIC 20" 4-POST	\$ 1,129.50
GRIZZLY G-5850 20" & G9740	\$ 1,318.50
GRIZZLY G-7213 24"	\$ 1,602.00
HITACHI F1000	\$ 517.50
INVICTA DGI 40 16"	\$ 2,412.00
INVICTA DGI 52 20" (DELTA RC-51)	\$ 2,736.00
INVICTA DGI 63 24" (DELTA RC-63)	\$ 3,303.00
JET JPM 13" PLANER / MOULDER	\$ 940.50
JET JWP-13DX W/BRGS	\$ 423.00
JET JWP-160S 16"	\$ 1,129.50
MAKITA 2030 OR 2030N 12"	\$ 828.00
MAKITA 2040 16"	\$ 1,107.00
MAKITA -KP312 W/BRGS	\$ 423.00
MARTIN T45 25"	\$ 3,393.00
NORTHFIELD #240 24" DBL	\$ 3,303.00
NORTHFIELD #7 24"	\$ 3,775.50
OLIVER 18" DOUBLE	\$ 3,492.00
OLIVER MODEL 299D 25"	\$ 3,492.00
OLIVER MODEL 399D 18"	\$ 2,358.00
OLIVER MODEL 4455 22"	\$ 1,507.50
OLIVER MODEL 4470 24" NEW STYLE	\$ 1,696.50
PINHERO 25"	\$ 3,586.50
POWERMATIC 221 20"	\$ 1,665.00
POWERMATIC 22" WP-2412	\$ 2,074.50
POWERMATIC M201 22"	\$ 1,507.50
POWERMATIC MODEL 15 15"	\$ 751.50
POWERMATIC MODEL 208 & 209 - 20"	\$ 1,129.50
POWERMATIC P 100 12"	\$ 846.00
POWERMATIC P 160 16"	\$ 1,318.50
POWERMATIC P 180 18"	\$ 1,507.50
POWERMATIC P 225 24"	\$ 3,303.00
POWERMATIC PM-15 15" PLANER/MOULDER	\$ 940.50
RIGID R4330 / TP1300 W/BRGS	\$ 423.00
ROBLAND 12" JOINTER/PLANER	\$ 940.50
S.A.C. 530 20"	\$ 2,736.00
S.A.C. 630 25"	\$ 3,303.00
SCMI S520 20"	\$ 2,736.00
SCMI S630 24"	\$ 3,303.00
SEARS-CRAFTSMAN 351.217430-13"	\$ 423.00
SECO SK-824WP 24"	\$ 2,074.50
WOODMASTER 812 18"	\$ 1,602.00
YORKCRAFT YC-15P 15"	\$ 751.50

BYRD TOOL

Standard Molder and Shaper Series

PART#	DIA.	LENGTH	BORE	PRICE
48600806-29	6	2	1-13/16 STRAIGHT	\$360.90
48601606-29	6	4	1-13/16 STRAIGHT	\$504.00
48602406-29	6	6	1-13/16 STRAIGHT	\$646.20
48603206-29	6	8	1-13/16 STRAIGHT	\$789.30
48604006-29	6	10	1-13/16 STRAIGHT	\$922.50
49600806-29	6	2	1-13/16 HYD.	\$541.80
49601606-29	6	4	1-13/16 HYD.	\$751.50
49602406-29	6	6	1-13/16 HYD.	\$966.60
49603206-29	6	8	1-13/16 HYD.	\$1173.60
49604006-29	6	10	1-13/16 HYD.	\$1378.80
49600806-34	6	2	2-1/8 HYD.	\$541.80
49601606-34	6	4	2-1/8 HYD.	\$751.50
49602406-34	6	6	2-1/8 HYD.	\$1074.00
49603206-34	6	8	2-1/8 HYD.	\$1173.60
49604006-34	6	10	2-1/8 HYD.	\$1378.80
50600806-34	6	2	2-1/8 CONED.	\$423.90
50601606-34	6	4	2-1/8 CONED.	\$814.50
50602406-34	6	6	2-1/8 CONED.	\$126.00
50603206-34	6	8	2-1/8 CONED.	\$1014.30
50604006-34	6	10	2-1/8 CONED.	\$1198.80

Small Molder and Shaper Series

PART#	DIAMETER	LENGTH	BORE	PRICE
48300402-5	3	1	1-1/4	\$103.50
48300802-3	3	2	3/4	\$132.30
48300802-4	3	2	1	\$132.30
48300802-5	3	2	1-1/4	\$132.30
48301202-3	3	3	3/4	\$189.00
48301202-4	3	3	1	\$189.00
48301202-5	3	3	1-1/4	\$189.00
48301602-3	3	4	3/4	\$245.70
48301602-4	3	4	1	\$245.70
48301602-5	3	4	1-1/4	\$245.70
48350403-5	3-1/2	1	1-1/4	\$103.50
48400803-5	4	2	1-1/4	\$132.30
48401203-5	4	3	1-1/4	\$234.00
48401603-5	4	4	1-1/4	\$245.00
48402403-5	4	6	1-1/4	\$378.00
48430803-5	4-3/8	2	1-1/4	\$132.30
48431603-5	4-3/8	4	1-1/4	\$245.70
48432403-5	4-3/8	6	1-1/4	\$378.00

3" OD BBRC For Above @ \$56.00 Over 3" OD @ \$68.00
Shim @ \$7.25

Mid Size Molder Series

PART#	DIA.	LENGTH	BORE	PRICE
48480804-24	4-13/16	2	1-1/2	\$178.20
48481604-24	4-13/16	4	1-1/2	\$301.50
48482004-24	4-13/16	5	1-1/2	\$367.20
48482804-24	4-13/16	7	1-1/2	\$490.50
48483604-24	4-13/16	9	1-1/2	\$612.90
48480904-25M	122mm	60mm	40mm	\$207.60
48481604-25M	122mm	100mm	40mm	\$301.50
48482004-25M	122mm	130mm	40mm	\$367.20
48482404-25M	122mm	150mm	40mm	\$414.90
48482804-25M	122mm	180mm	40mm	\$490.50
48423604-25M	122mm	230mm	40mm	\$612.90
48551603-29	140mm	4	1-13/16	\$361.80
48553603-29	140mm	9	1-13/16	\$738.00

INSERT TOOLING



When replacing or rotating inserts, the seat should be as clean as possible. This will prevent breakage of inserts and ensure proper insert alignment. To properly align the insert, press the insert away from the seat while tightening to approximately 45 inch pounds torque. This allows the countersink to slide up the tip into its proper position.

We have two types of torque wrenches available:

- Standard Break \$85.50
- Screwdriver type (torque limiter calibrated and set) . . . \$166.50



BYRD TOOL INSERT TOOLING

3 Wing Stile and Rail Cutters

****Tips on this page are interchangeable with the same Rail/Stile Head**

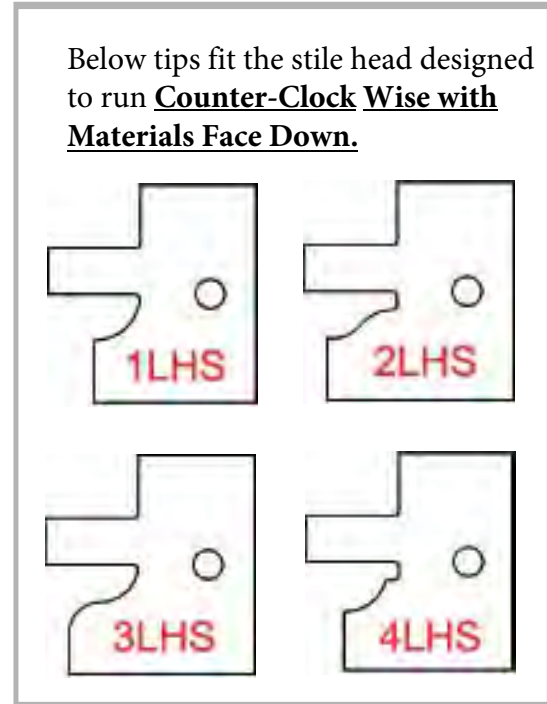
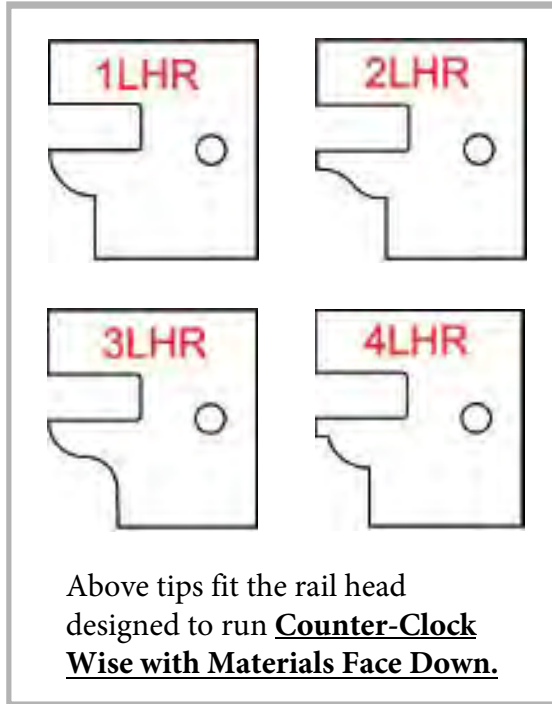

Head can be **3/4" Bore - 4" Dia** for R.H. or L.H.
 Use Part # with /3 to Order 3/4" Bore Set **i.e. 2LHR/3**

Head can be **1-1/4" Bore - 4-1/2" Dia** for R.H. or L.H.
 Use Part # with /5 to Order 1-1/4" Bore Set **i.e. 4LHS/5**

Tips are shown Full Size 30mm * 30mm.

Groove is 1/2" X 1/4"

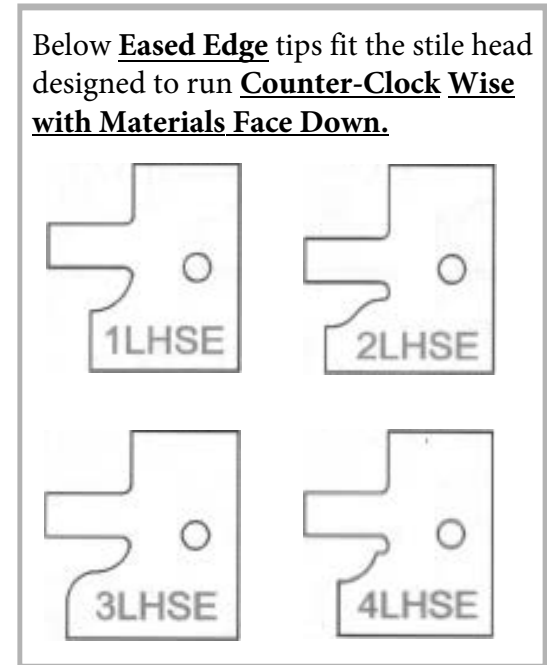
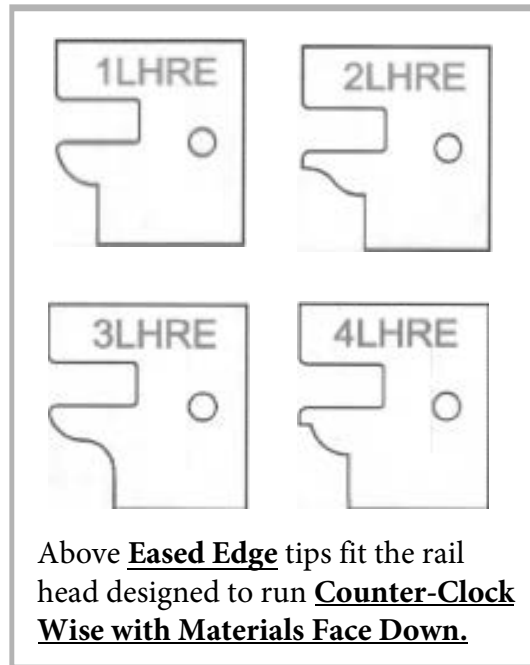

Price for Rail Head with 1 Set of Tips is \$293.55

Price for Stile Head with 1 Set of Tips is \$293.55

Replacement Tips are \$81.00 Per Set of 3

Price for 3" Diameter Rub Bearing for 3/4 Bore is \$48

Price for 3-1/2" Diameter Rub Bearing for 1-1/4" Bore is \$48

BYRD TOOL INSERT TOOLING

3 Wing Stile and Rail Cutters

****Tips on this page are interchangeable with the same Rail/Stile Head**



RAIL CUTTER



STILE CUTTER

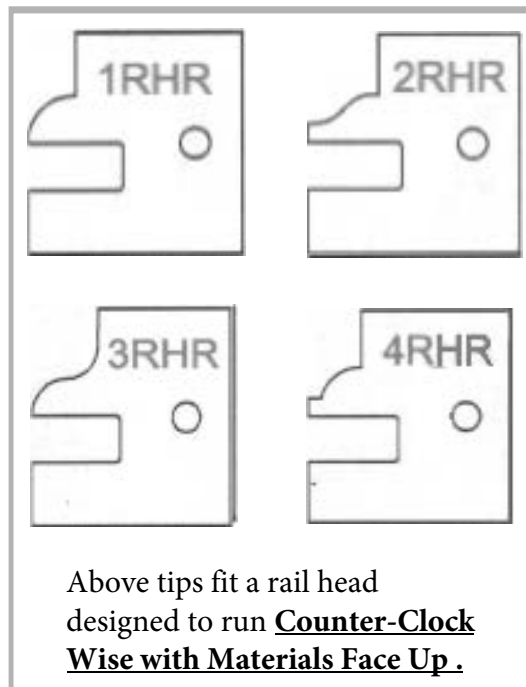

Above tips fit a rail head designed to run **Counter-Clock Wise with Materials Face Up.**

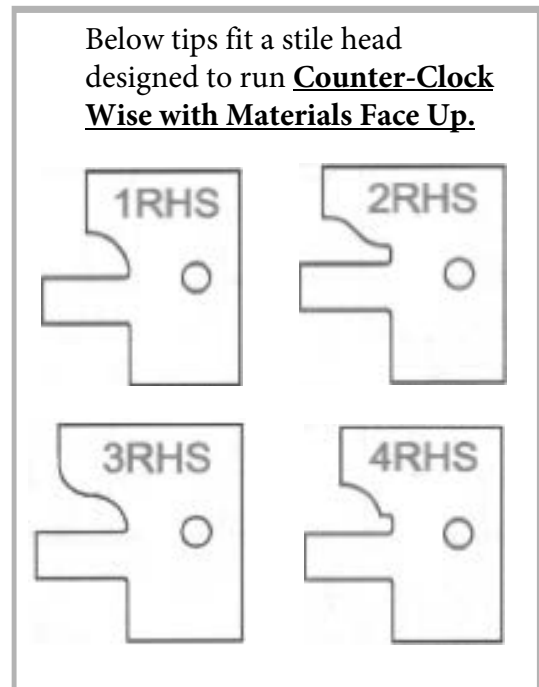

Below tips fit a stile head designed to run **Counter-Clock Wise with Materials Face Up.**

Head can be **3/4" Bore - 4" Dia** for R.H. or L.H.
 Use Part # with /3 to Order 3/4" Bore Set **i.e. 2RHR/3**

Head can be **1-1/4" Bore - 4-1/2" Dia** for R.H. or L.H.
 Use Part # with /5 to Order 1-1/4" Bore Set **i.e. 4RHS/5**

Tips are shown Full Size 30mm * 30mm.

Groove is 1/2" X 1/4"

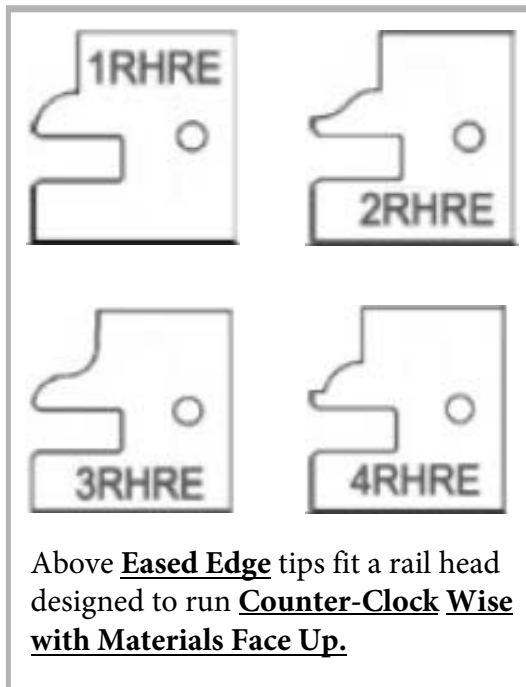

Above **Eased Edge** tips fit a rail head designed to run **Counter-Clock Wise with Materials Face Up.**

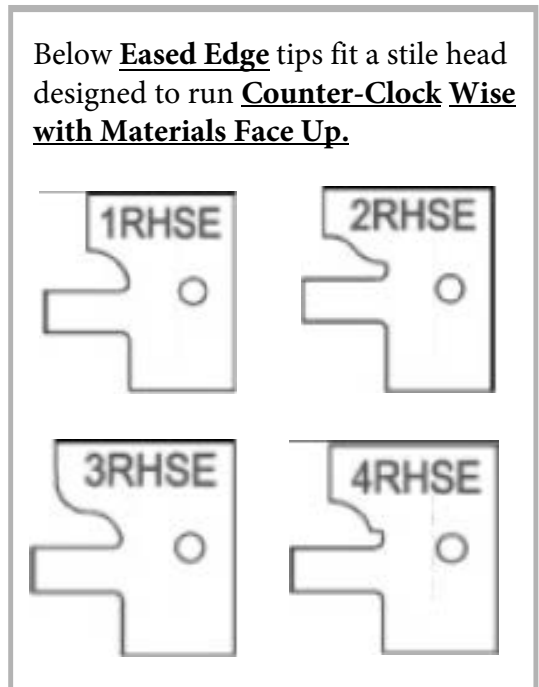

Below **Eased Edge** tips fit a stile head designed to run **Counter-Clock Wise with Materials Face Up.**

Price for Rail Head with 1 Set of Tips is **\$293.55**

Price for Stile Head with 1 Set of Tips is **\$293.55**

Replacement Tips are **\$81.00** Per Set of 3

Price for 3" Diameter Rub Bearing for 3/4 Bore is **\$48**

Price for 3-1/2" Diameter Rub Bearing for 1-1/4" Bore is **\$48**

BYRD TOOL INSERT TOOLING

3 Wing Stile and Rail Cutters

****Glass Door Tool Bodies Are Required**

****Tips on this page are interchangeable with the same Rail/Stile Head**



RAIL CUTTER



STILE CUTTER

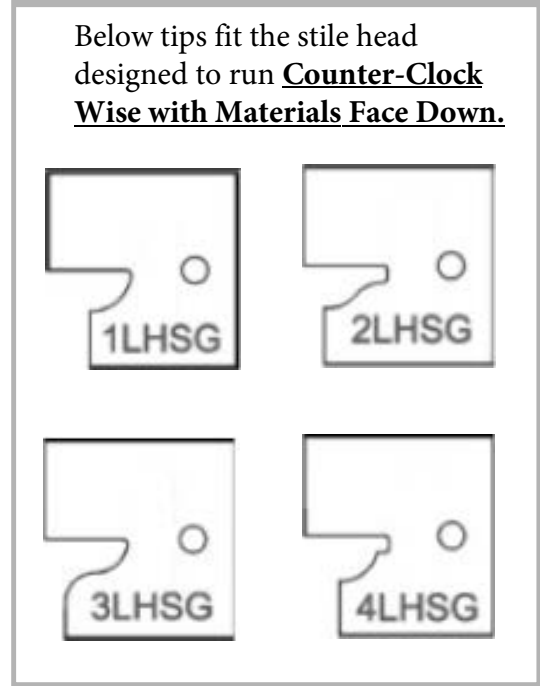
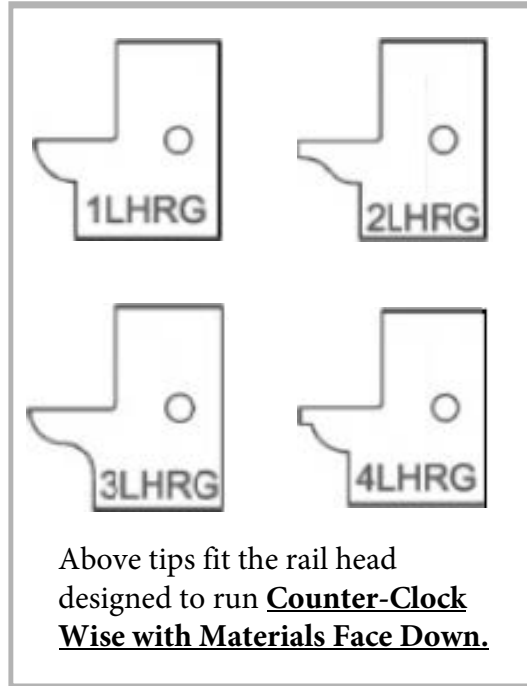

Head can be 3/4" Bore - 4" Dia for R.H. or L.H.
 Use Part # with /3 to Order 3/4" Bore Set i.e. 2LHRG/3

Head can be 1-1/4" Bore - 4-1/2" Dia for R.H. or L.H.
 Use Part # with /5 to Order 1-1/4" Bore Set i.e. 4LHRGE/5

Tips are shown Full Size 30mm * 30mm.

Groove is 1/2" X 1/4"

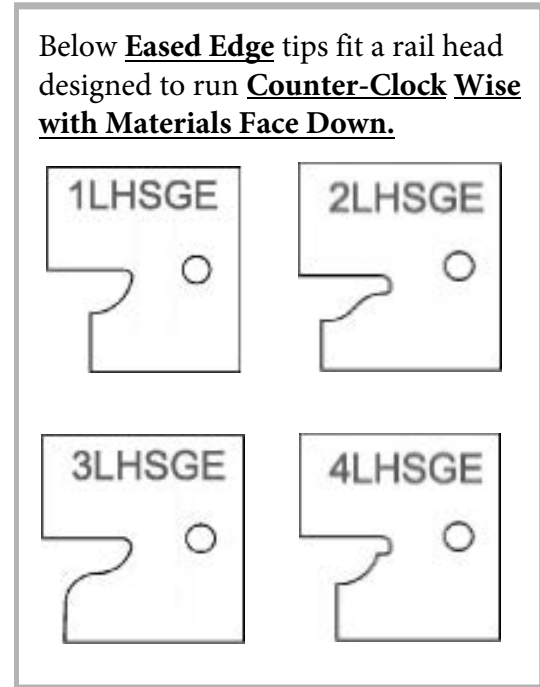
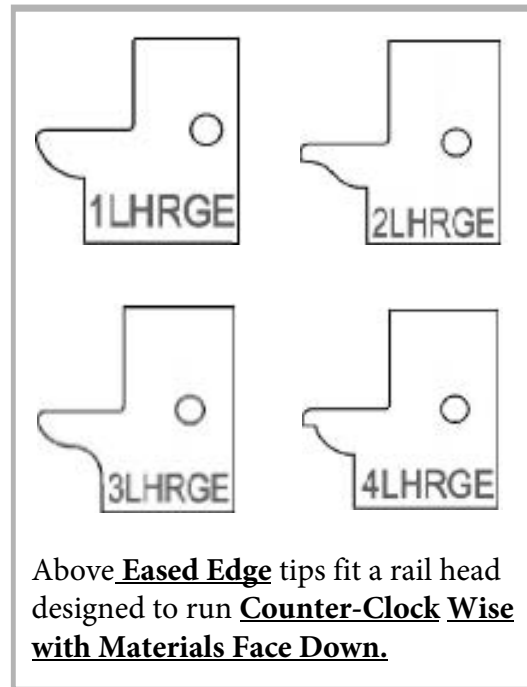

Price for Rail Head with 1 Set of Tips is **\$293.55**

Price for Stile Head with 1 Set of Tips is **\$293.55**

Replacement Tips are **\$81.00** Per Set of 3

Price for 3" Diameter Rub Bearing for 3/4 Bore is **\$48**

Price for 3-1/2" Diameter Rub Bearing for 1-1/4" Bore is **\$48**

BYRD TOOL INSERT TOOLING

3 Wing Stile and Rail Cutters

****Glass Door Tool Bodies Are Required**

****Tips on this page are interchangeable with the same Rail/Stile Head**



RAIL CUTTER



STILE CUTTER

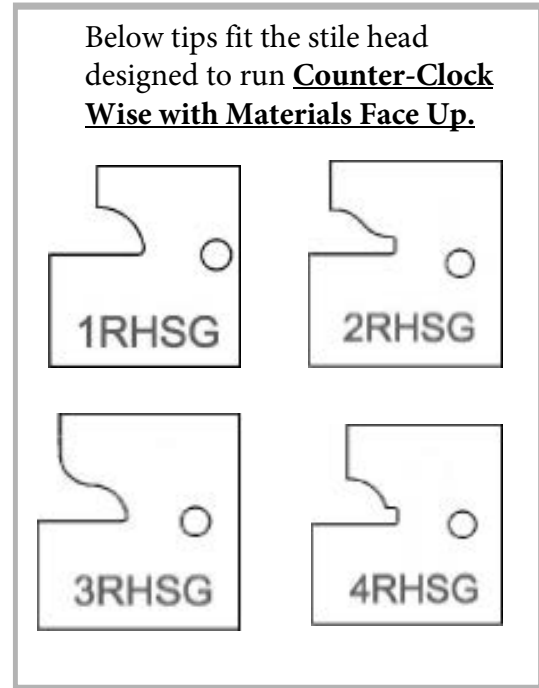
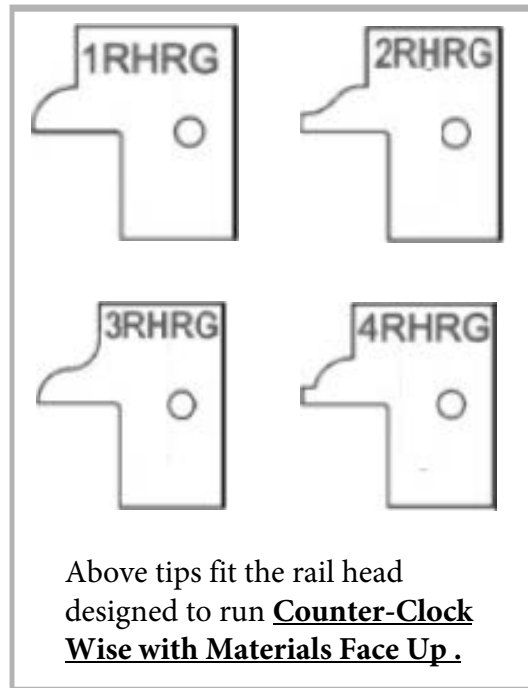

Head can be **3/4" Bore - 4" Dia** for R.H. or L.H.
 Use Part # with /3 to Order 3/4" Bore Set **i.e. 2RHR/3**

Head can be **1-1/4" Bore - 4-1/2" Dia** for R.H. or L.H.
 Use Part # with /5 to Order 1-1/4" Bore Set **i.e. 4RHS/5**

Tips are shown Full Size 30mm * 30mm.

Groove is 1/2" X 1/4"

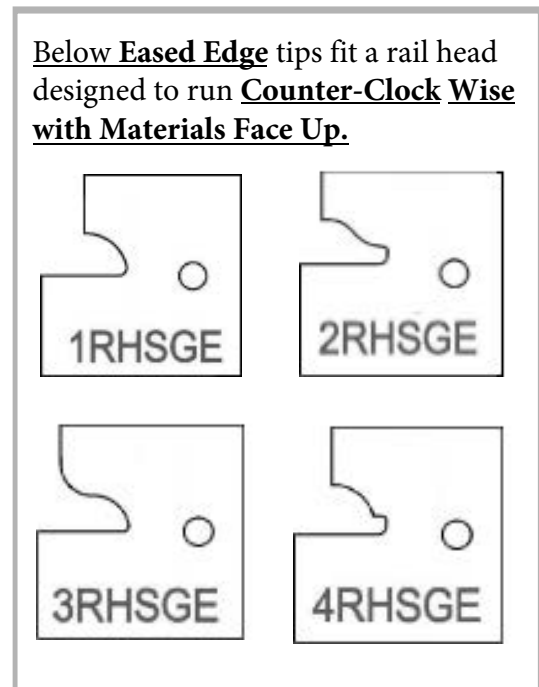
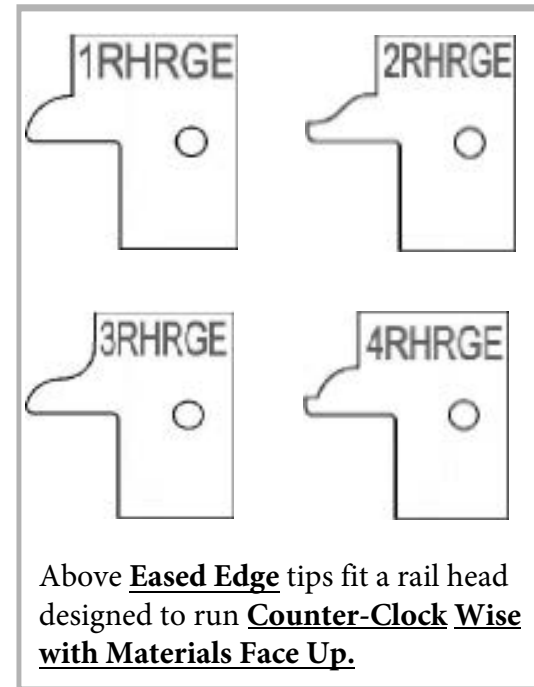

Price for Rail Head with 1 Set of Tips is **\$293.55**

Price for Stile Head with 1 Set of Tips is **\$293.55**

Replacement Tips are **\$81.00** Per Set of 3

Price for 3" Diameter Rub Bearing for 3/4 Bore is **\$48**

Price for 3-1/2" Diameter Rub Bearing for 1-1/4" Bore is **\$48**

BYRD TOOL INSERT TOOLING

3 Wing Stile and Rail Cutters

****Shaker Style Tool Bodies Are Required**

Section 1

Available In:

3/4" Bore - 4" Diameter

Use Part # with /3 to Order
3/4" Bore Set **i.e. 5LR/3**

1-1/4" Bore - 4-1/2" Diameter

Use Part # with /5 to Order
1-1/4" Bore Set **i.e. 5SE/5**

Price for Rail/Stile Heads plus 1
Set of Tips is **\$293.55**

Price for Rail/Stile Heads plus 1
Set of Tips is **\$293.55**

Replacement Tips are **\$81.00** Per
Set of 3

8 patterns in **Section 1** are
centered so that **Rail/Stile**
patterns are interchangeable
in the same Rail/Stile body.

***Watch for Rotation Preference**

12 Degree Angle

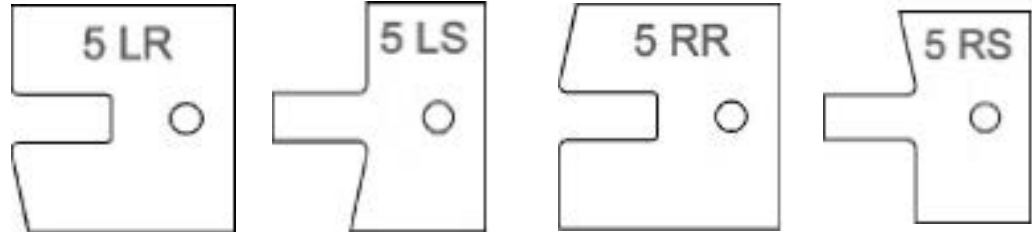

Above 2 tips fit the rail/stile heads designed to run
Counter-Clock Wise with Materials Face Down.

Above 2 tips fit the rail/stile heads designed to run
Counter-Clock Wise with Materials Face Up.

Regular

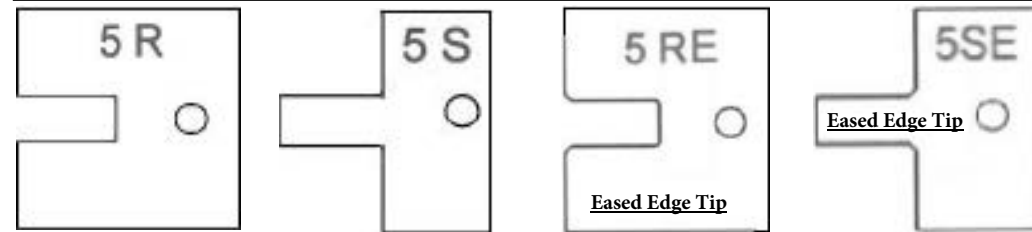

Section 2

Available In:

3/4" Bore - 4" Diameter

Use Part # with /3 to Order
3/4" Bore Set **i.e. 5LR/3**

1-1/4" Bore - 4-1/2" Diameter

Use Part # with /5 to Order
1-1/4" Bore Set **i.e. 7RR/5**

Price for Rail/Stile Heads
plus 1 Set of Tips is **\$293.55**

Price for Rail/Stile Heads
plus 1 Set of Tips is **\$293.55**

Replacement Tips are **\$81.00**
Per Set of 3

Patterns in **Section 2** are
interchangeable **in the same**
Rail/Stile head.

***Watch for Rotation Preference**

Regular

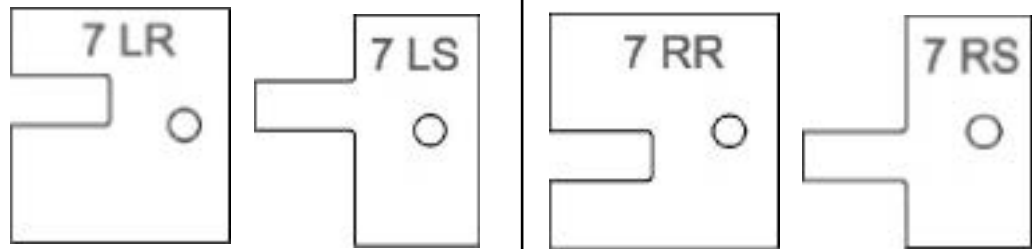
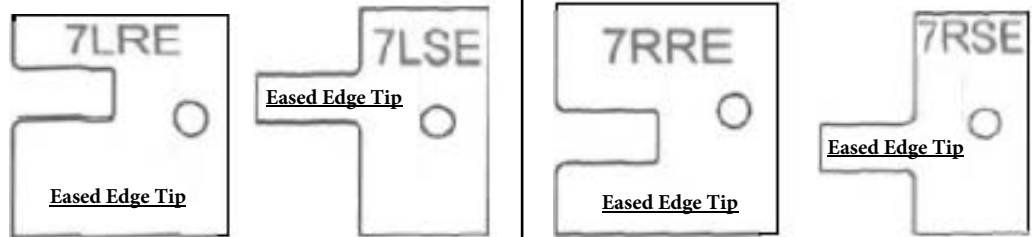

12 Degree Angle

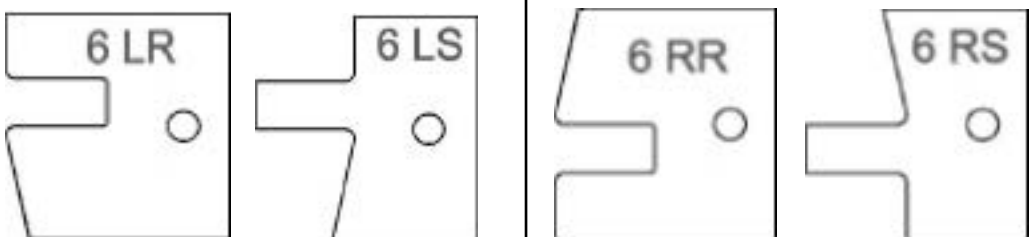

Above **6 tips in Section 2** fit the rail/stile head designed to
run **Counter-Clock Wise with Materials Face Down.**

Above **6 tips in Section 2** fit the rail/stile head designed
to run **Counter-Clock Wise with Materials Face Up.**

BYRD TOOL INSERT TOOLING - Door Edge Cutter



3" Minor Dia. 3/4" Bore
3-1/2" Minor Dia.
1-1/4" Bore Cutters @
293.55 Each with Tips

5" Minor Dia. 1-1/4"
Bore Cutters @ 331.55
Each with Tips

Extra Tips @ 81.00
Per Set of 3

Tips are shown Full
Size 30mm * 30mm.

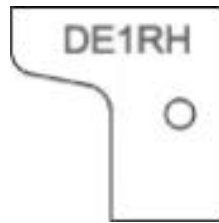

Below tips fit a 3 Wing
Head designed to run
**Counter-Clock Wise with
Materials Face Down.**

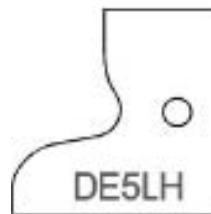
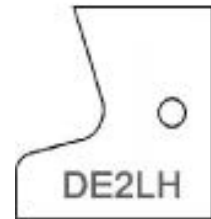
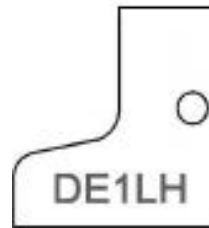

Above tips fit a 3 Wing
Head designed to run
**Counter-Clock Wise
with Materials Face Up.**

BYRD TOOL INSERT TOOLING

Flooring Cutters

FOR 3/4" WOOD

Insert Heads Are
4-7/8" DIA. X 3 Wing X 30mm
with your choice of
1-1/4" - 40MM - OR
1-1/2" DIA. BORE

Price for Rail Heads plus 1
Set of Tips is \$293.55

Price for Stile Heads plus 1
Set of Tips is \$293.55

Or Choice Of
6"DIA. X 3 WING X
30mm X 1-13/16"
BORE CUTTERS

Price for Rail Heads plus 1
Set of Tips is \$331.55

Price for Stile Heads plus 1
Set of Tips is \$331.55

FOR 3/4" WOOD
EXTRA TIPS \$81.00
PER SET OF 3

1-2-3 REPRESENTS
1/16" - 1/8" - 1/4"
REVEAL

Below tips fit a 3 Wing Insert Head designed to run
Counter-Clock Wise with Materials Face Down.

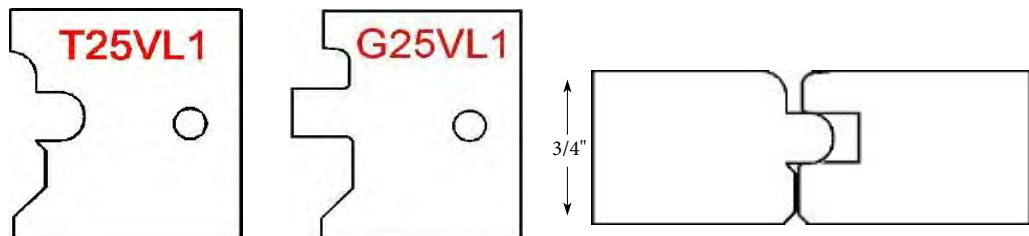
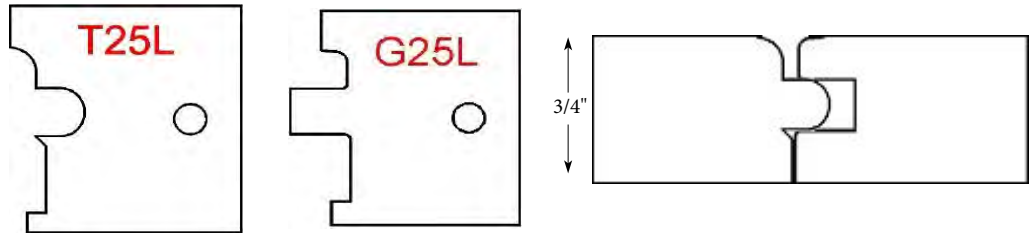

1/16" REVEAL

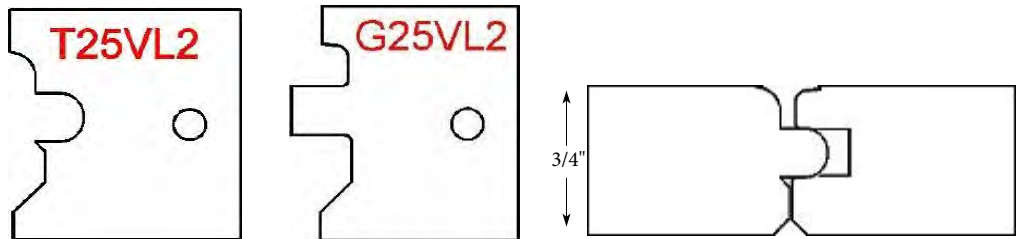

1/8" REVEAL

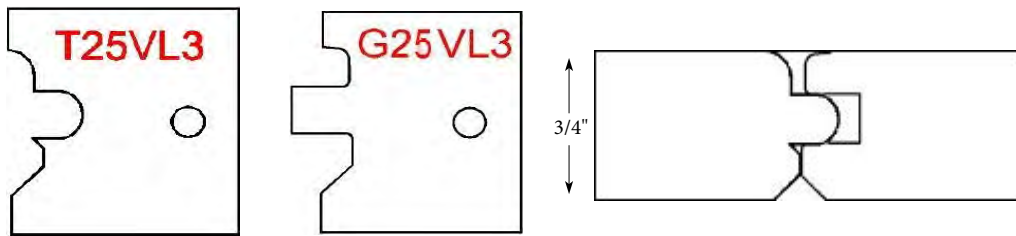

1/4" REVEAL

BYRD TOOL INSERT TOOLING

Flooring Cutters

FOR 3/4" WOOD

Insert Heads Are
4-7/8" DIA. X 3 Wing X 30mm
with your choice of
1-1/4" - 40MM - OR
1-1/2" DIA. BORE

Price for Rail Heads plus 1
Set of Tips is **\$293.55**

Price for Stile Heads plus 1
Set of Tips is **\$293.55**

Or Choice Of
6"DIA. X 3 WING X
30mm X 1-13/16"
BORE CUTTERS

Price for Rail Heads plus 1
Set of Tips is **\$331.55**

Price for Stile Heads plus 1
Set of Tips is **\$331.55**

FOR 3/4" WOOD
EXTRA TIPS **\$81.00**
PER SET OF 3

1-2-3 REPRESENTS
1/16" - 1/8" - 1/4"
REVEAL

Below tips fit a 3 Wing Insert Head designed to run
Counter-Clock Wise with Materials Face Up.

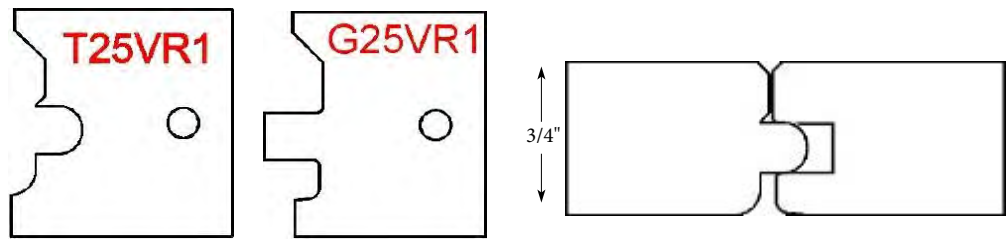
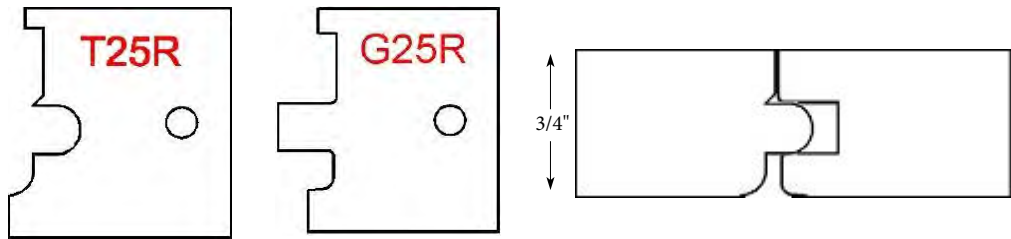

1/16" REVEAL

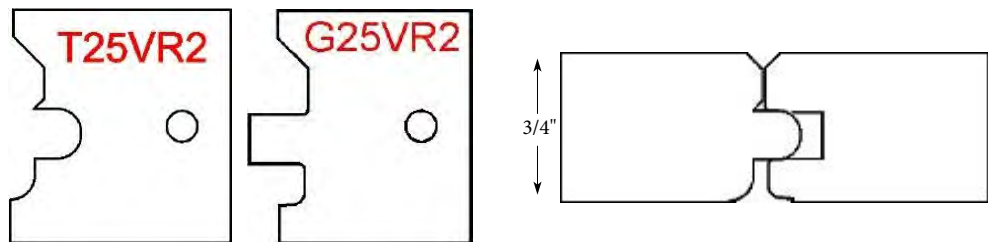

1/8" REVEAL

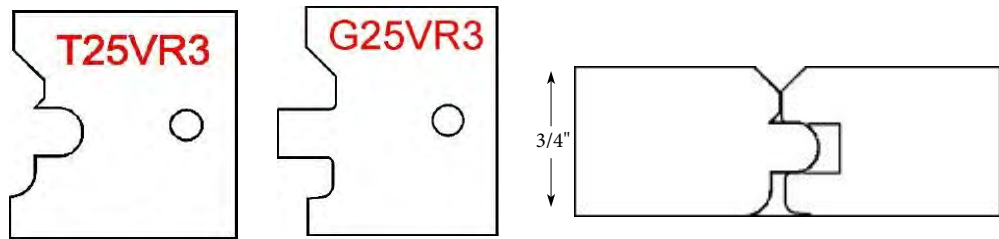

1/4" REVEAL

BYRD TOOL INSERT TOOLING
Flooring Cutters

FOR 1/2" WOOD

Insert Heads Are
 4-7/8" DIA. X 3 Wing X 30mm
 with your choice of
 1-1/4" - 40MM - OR
 1-1/2" DIA. BORE

Price for Rail Heads plus 1
Set of Tips is \$293.55

Price for Stile Heads plus 1
Set of Tips is \$293.55

Or Choice Of
 6"DIA. X 3 WING X
 30mm X 1-13/16"
 BORE CUTTERS
\$331.55 EACH

Price for Rail Heads plus 1
Set of Tips is \$331.55

Price for Stile Heads plus 1
Set of Tips is \$331.55

FOR 3/4" or 1/2" WOOD
 EXTRA TIPS **\$81.00 PER**
 SET OF 3

Heads have to be trimmed
 for 1/2" tips (Need To
 Know Before Order)

1-2-3 REPRESENTS
1/16" - 1/8" - 1/4"
REVEAL

Below tips fit a 3 Wing Insert Head designed to run
Counter-Clock Wise with Materials Face Down.

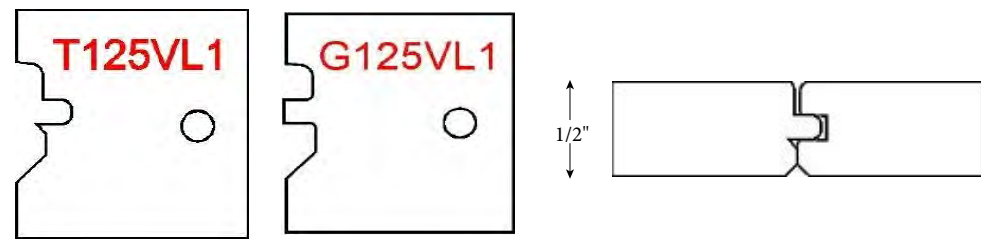
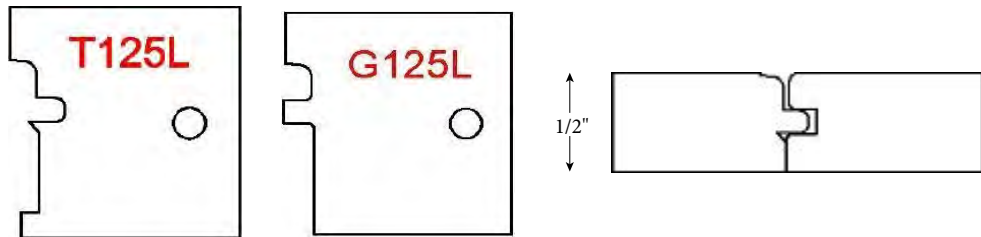

1/16" REVEAL

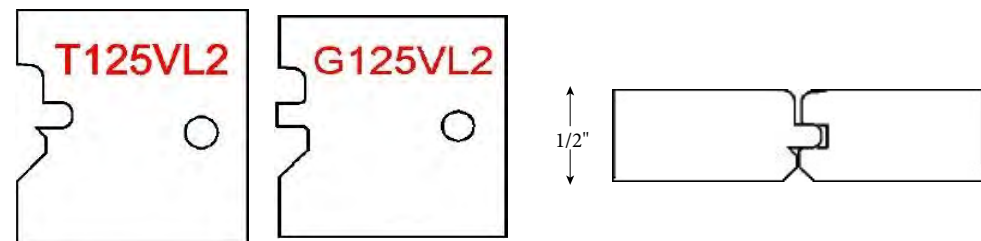

1/8" REVEAL

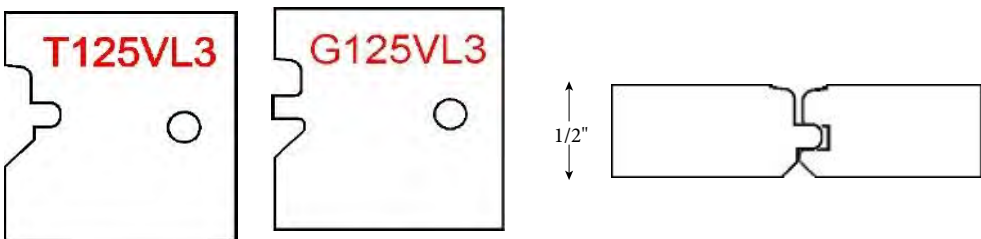

1/4" REVEAL

BYRD TOOL INSERT TOOLING

FOR 1/2" WOOD

Flooring Cutters

Insert Heads Are
4-7/8" DIA. X 3 Wing X 30mm
with your choice of
1-1/4" - 40MM - OR
1-1/2" DIA. BORE

Price for Rail Heads plus 1
Set of Tips is **\$293.55**

Price for Stile Heads plus 1
Set of Tips is **\$293.55**

Or Choice Of
6"DIA. X 3 WING X
30mm X 1-13/16"
BORE CUTTERS

Price for Rail Heads plus 1
Set of Tips is **\$331.55**

Price for Stile Heads plus 1
Set of Tips is **\$331.55**

FOR 3/4" WOOD
EXTRA TIPS **\$81.00**
PER SET OF 3

1-2-3 REPRESENTS
1/16" - 1/8" - 1/4"
REVEAL

Below tips fit a 3 Wing Insert Head designed to run
Counter-Clock Wise with Materials Face Up.

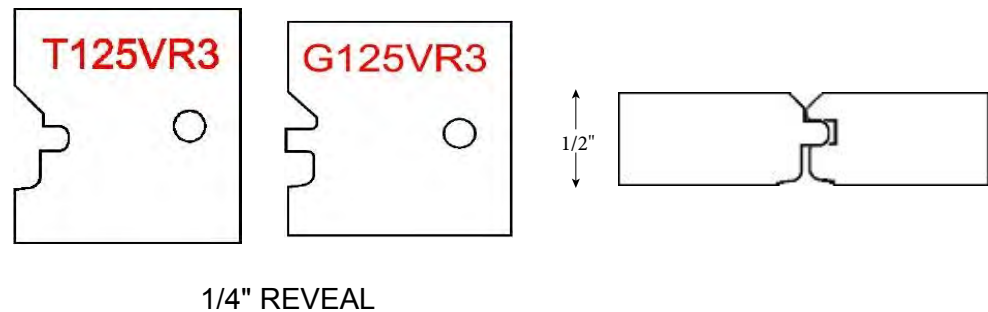
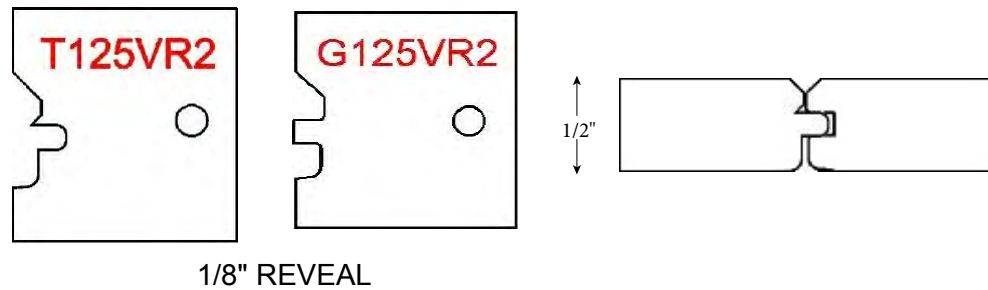
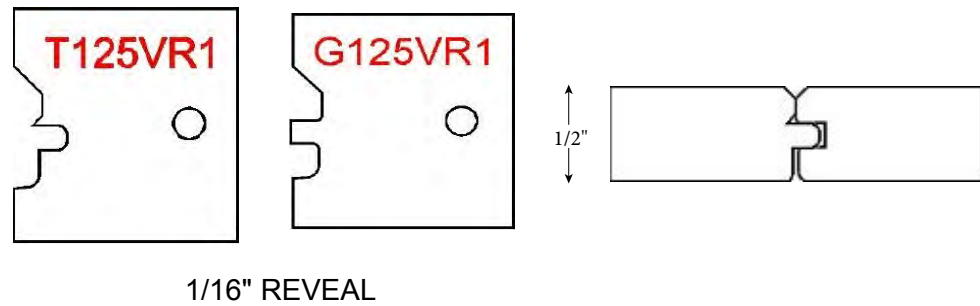
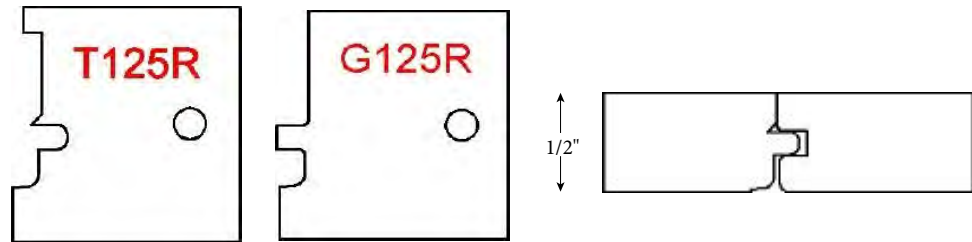

BYRD TOOL INSERT TOOLING

Flooring Cutters

FOR 3/4" WOOD

Insert Heads Are
4-7/8" DIA. X 3 Wing X 30mm
with your choice of
1-1/4" - 40MM - OR
1-1/2" DIA. BORE

Price for Rail Heads plus 1
Set of Tips is \$293.55

Price for Stile Heads plus 1
Set of Tips is \$293.55

Or Choice Of
6"DIA. X 3 WING X
30mm X 1-13/16"
BORE CUTTERS

Price for Rail Heads plus 1
Set of Tips is \$331.55

Price for Stile Heads plus 1
Set of Tips is \$331.55

FOR 3/4" WOOD
EXTRA TIPS **\$81.00**
PER SET OF 3

1-2-3 REPRESENTS
1/16" - 1/8" - 1/4"
REVEAL

Below tips fit a 3 Wing Insert Head designed to run
Counter-Clock Wise with Materials Face Down.

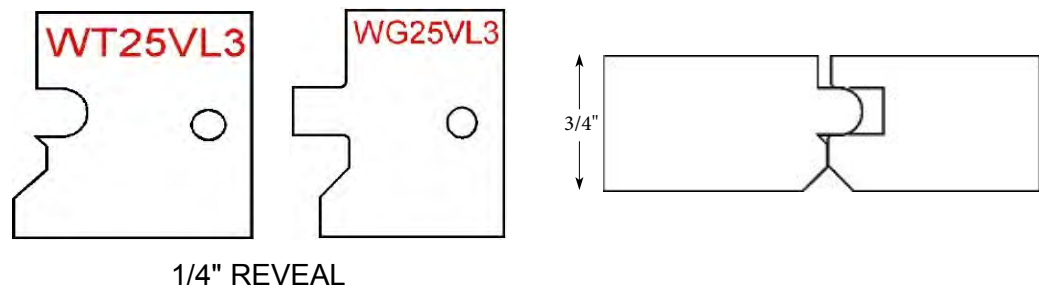
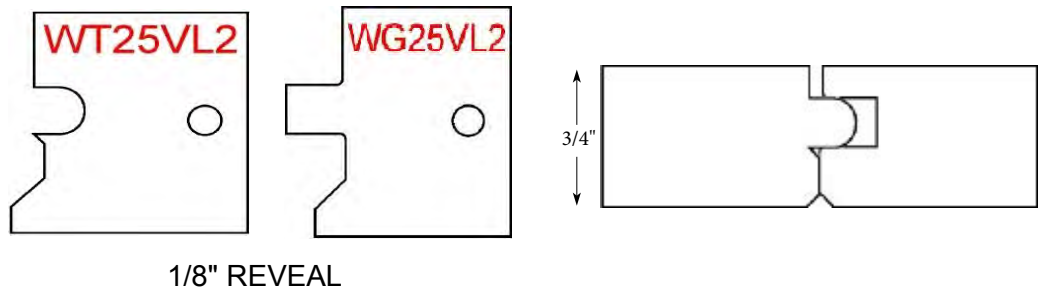
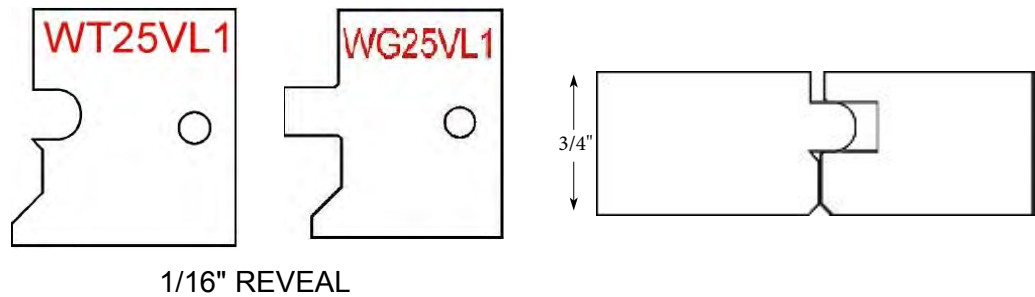
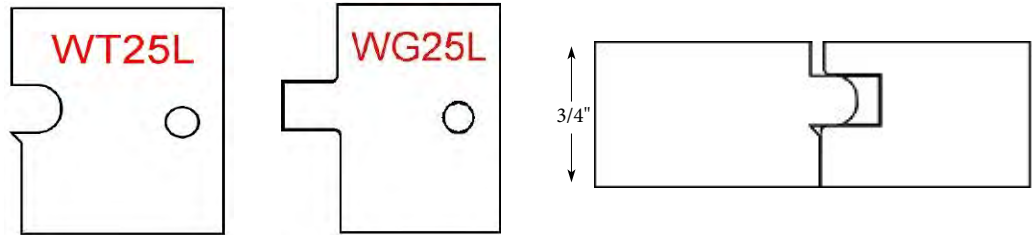

BYRD TOOL INSERT TOOLING

FOR 3/4" WOOD

Flooring Cutters

*****Must Have "W" Style Heads to Run These Tips*****

Insert Heads Are
4-7/8" DIA. X 3 Wing X 30mm
with your choice of
1-1/4" - 40MM - OR
1-1/2" DIA. BORE

Price for Rail Heads plus 1
Set of Tips is **\$293.55**

Price for Stile Heads plus 1
Set of Tips is **\$293.55**

Or Choice Of
6"DIA. X 3 WING X
30mm X 1-13/16"
BORE CUTTERS

Price for Rail Heads plus 1
Set of Tips is **\$331.55**

Price for Stile Heads plus 1
Set of Tips is **\$331.55**

FOR 3/4" WOOD
EXTRA TIPS **\$81.00**
PER SET OF 3

1-2-3 REPRESENTS
1/16" - 1/8" - 1/4"
REVEAL

Below tips fit a 3 Wing Insert Head designed to run
Counter-Clock Wise with Materials Face Up .

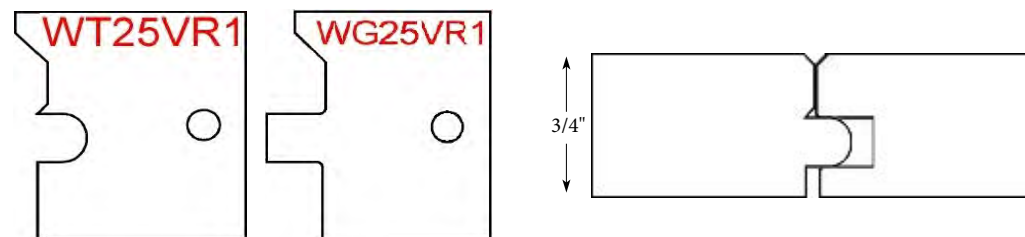
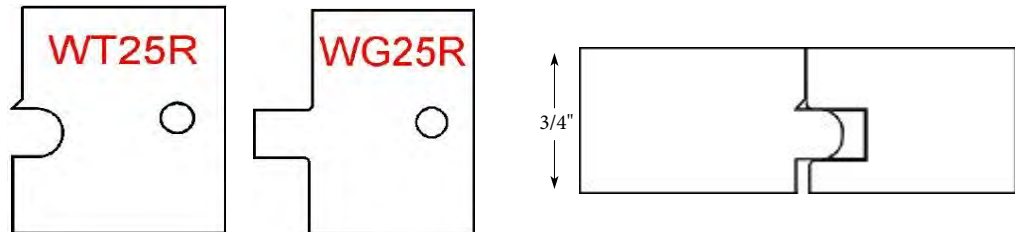

1/16" REVEAL

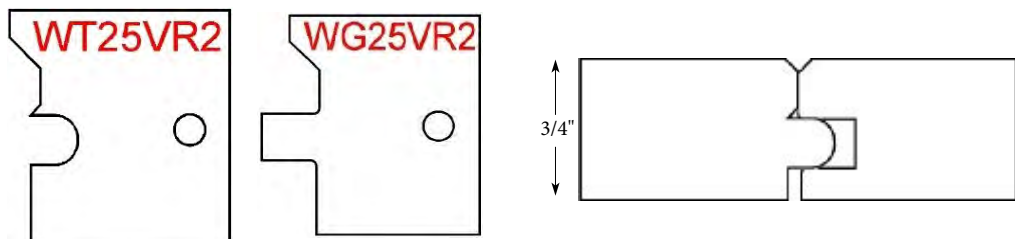

1/8" REVEAL

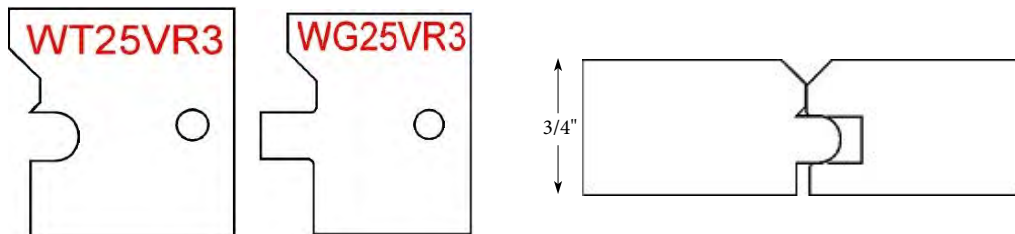

1/4" REVEAL

BYRD TOOL

RAISED PANEL CUTTERS

BACK CUTTER, TRIM CUTTER, BEARING RUB COLLAR OR SPACER ARE ALSO AVAILABLE TO USE WITH THESE 6" RAISED PANEL CUTTERS
 ALL CUTTERS 1-1/4" BORE - 3 WING - 6" DIAMETER
 ALL TIPS SHOWN FACE COMING - FULL SIZE



RAISED PANEL CUTTER

6" Diameter Raised Panel Cutters

@ **318.50** each with Tips

Extra Tips @ **93.00** per set of 3.

4-1/2" Diameter Back Cutters

@ **174.80** each with tips.

Extra tips @ **33.00** per set of 3.

3" Diameter Trim Cutter @

148.20 each with Tips.

Extra Tips @ **15.00** per set 3.

UP To 3" BALL BEARING RUB

COLLAR @ **\$48.00** EACH

SPACER @ **\$22.00** EACH

**Insert Back Cutter and
 Insert Tongue Trimmer**

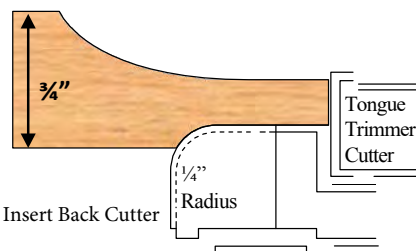

Below tips fit the raised panel head designed to run **Counter-Clock** **Wise with Materials Face Up.**

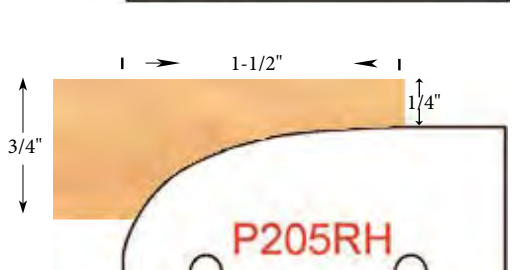
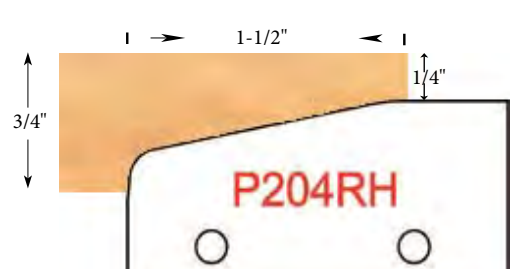
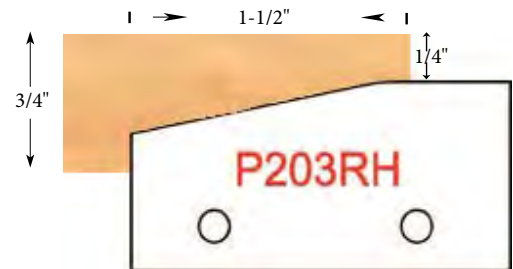
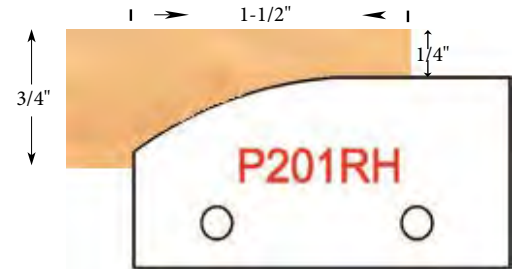
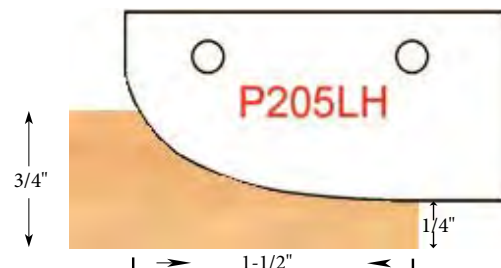
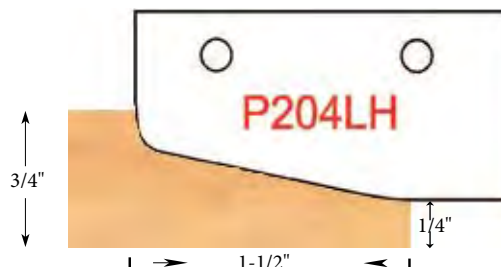
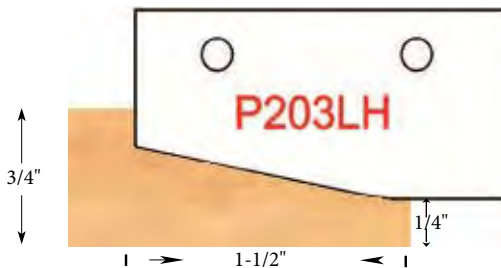
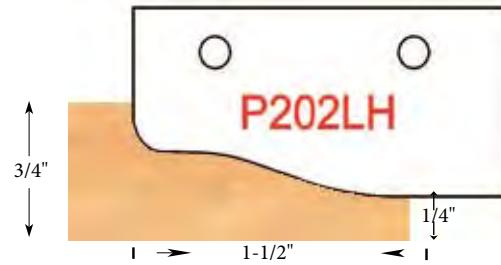
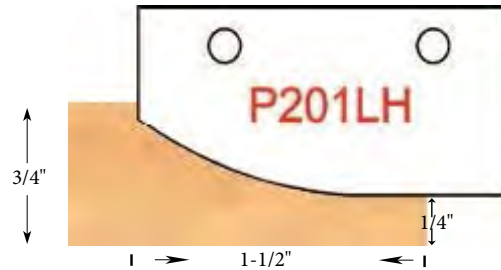

Above tips fit the raised panel head designed to run **Counter-Clock** **Wise with Materials Face Down.**

BYRD TOOL

RAISED PANEL CUTTERS

BACK CUTTER, TRIM CUTTER, BEARING RUB COLLAR OR SPACER ARE ALSO AVAILABLE TO USE WITH THESE 6" RAISED PANEL CUTTERS
 ALL CUTTERS 1-1/4" BORE - 3 WING - 6" DIAMETER
 ALL TIPS SHOWN FACE COMING - FULL SIZE



RAISED PANEL CUTTER

6" Diameter Raised Panel Cutters @ **318.50** each with Tips
 Extra Tips @ **93.00** per set of 3.
 4-1/2" Diameter Back Cutters @ **174.80** each with tips.
 Extra tips @ **33.00** per set of 3.
 3" Diameter Trim Cutter @ **148.20** each with Tips.
 Extra Tips @ **15.00** per set 3.
 UP To 3" BALL BEARING RUB COLLAR @ **\$48.00** EACH
 SPACER @ **\$22.00** EACH

Tips on this page ending with "S" are specially made for LARICK Shape & Sand Machine

Insert Back Cutter and Insert Tongue Trimmer

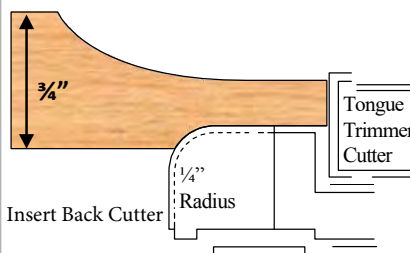

Below tips fit the raised panel head designed to run **Counter-Clock** **Wise with Materials Face Up.**

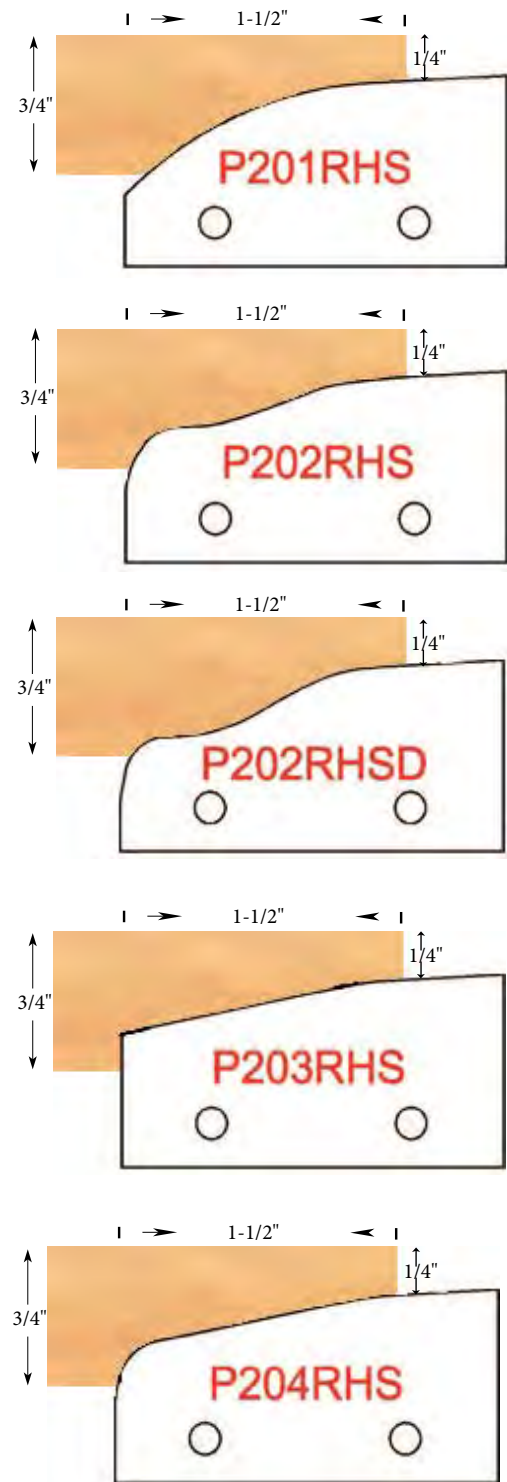
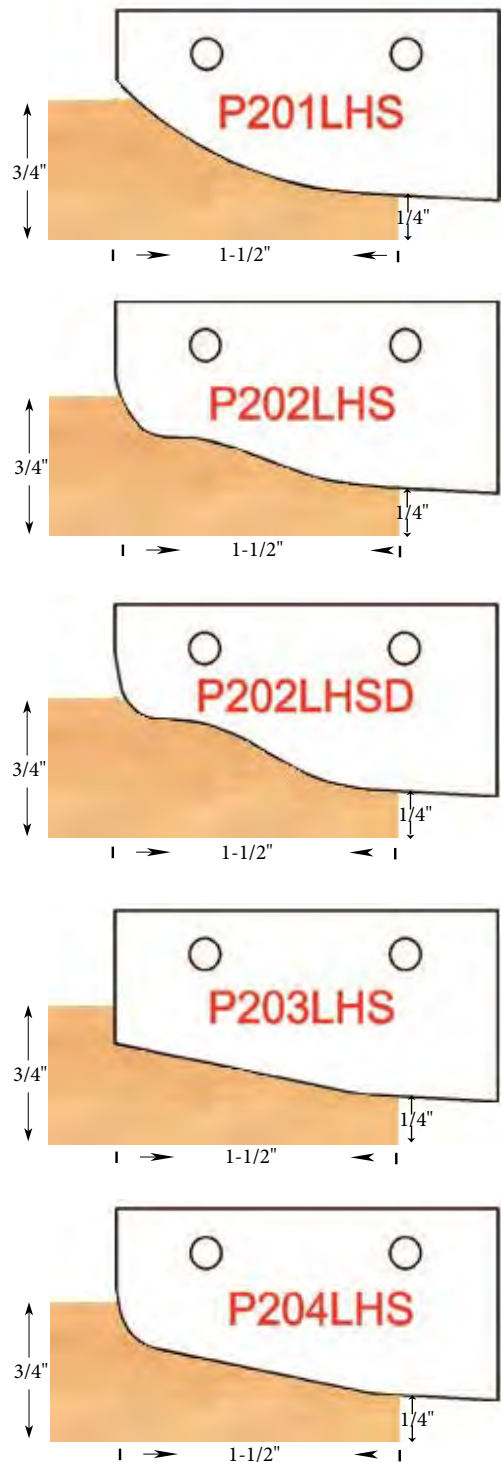

Above tips fit the raised panel head designed to run **Counter-Clock** **Wise with Materials Face Down.**

CMT

CMT333-03

Made In Italy

\$324.17

Blum, Salice and Häfele Hinges Boring System

The innovative CMT333 Universal Hinge Boring System employs three spindles which allow you to bore the holes for all of the major hinge brands. The universal modular base supports the installation of five different boring heads and the system can be utilized using drill presses or hand held power tools. The CMT333 is ideal for custom cabinet makers and it is a perfect compliment to boring machines that are dedicated to a specific brand. **The complete system CMT333-03 contains the modular base support and the boring head for Blum, Salice, Häfele and the 35mm hinge. (drill bits and boring bits not included).**

1. 5/16" shank suitable for any drilling machine

5. Greasing point

2. Depth lock

6. Double screws for drill clamping

3. Ground chromium plated slide bars

7. Slide bar for panel setting

4. Plywood base

8. 25/64" bore for panel setting bars



Technical Features and Specifications:

- Metal parts are ant-rust
- Ground aircraft aluminum
- Max 5000 RPM
- Six radial anti-friction bearings

Safety Tips: for lubrication use oil Mobil SHC100



CMT

Universal Hinges Boring System

Create your custom made universal boring system buying the components separately:

- universal modular base (CMT333);
- boring heads for different hinge brands (Grass, Blum, Salice, Häfele, Mepla, Hettich and Würth);
- boring head for system 32 (CMT333-325);
- drill bits and boring bits.

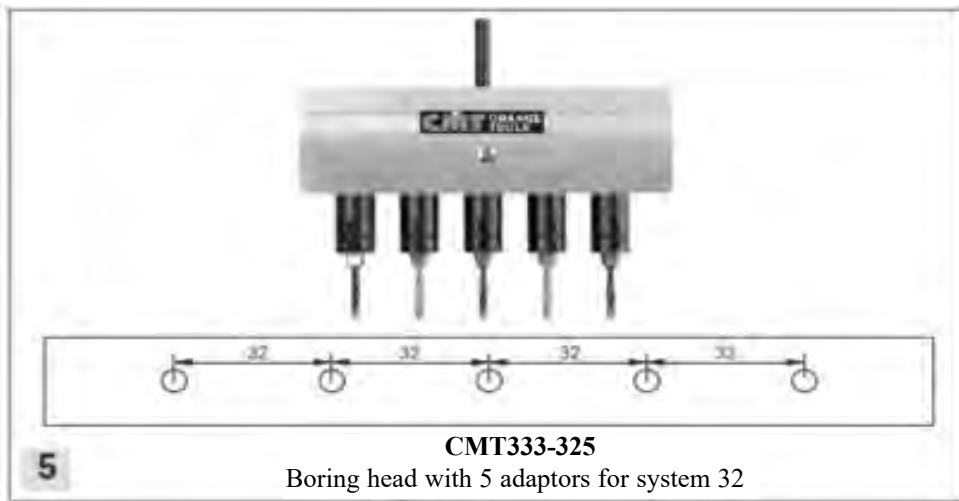
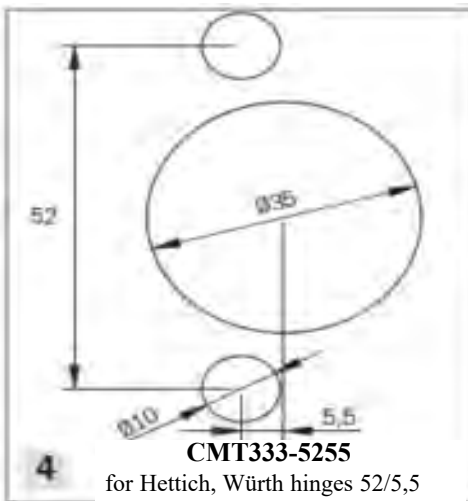
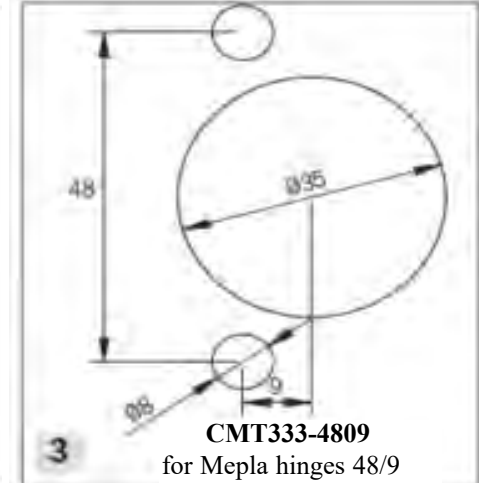
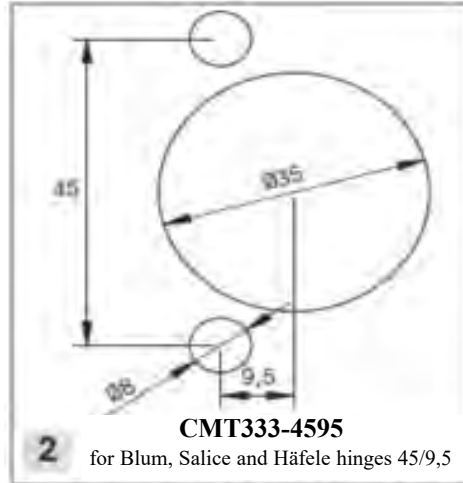
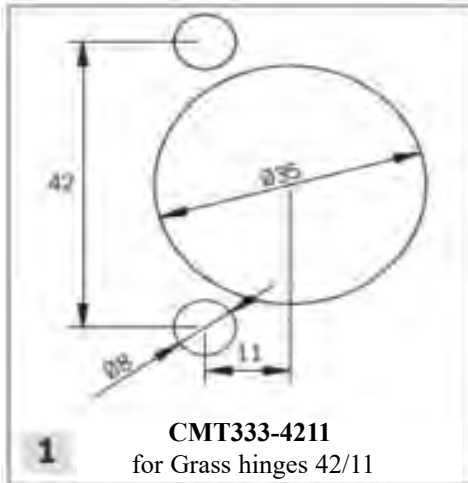

MAXIMUM VERSATILITY FOR ANY BRAND

SUPPORT MODULAR BASE	BORING HEADS	DRILL BITS	BORING BIT	MAKE YOUR SET
ORDER #	ORDER #	ORDER #	ORDER #	CHOOSE YOUR HINGE
CMT333	CMT333-4211 Grass	310.080.12 (2 pcs.)	317.350.11	Grass 42/11
CMT333	CMT333-4595 Blum	310.080.12 (2 pcs.)	317.350.11	Blum 45/9,5
CMT333	CMT333-4809 Mepla	310.080.12 (2 pcs.)	317.350.11	Mepla 48/9
CMT333	CMT333-5255 Hettich	310.100.12 (2 pcs.)	317.350.11	Hettich, Würth 52/5
CMT333	CMT333-325 System 32	310.050.11/12 (5 pcs.)	--	System 32

PRODUCT IMAGES AND PROFILES ARE NOT SHOWN ACTUAL SIZE

CMT Cutter Heads & Knives Profile Knives for the Insert Shaper System

Cutting length=1-37/64" (40mm) - Thickness=5/32" (4mm)

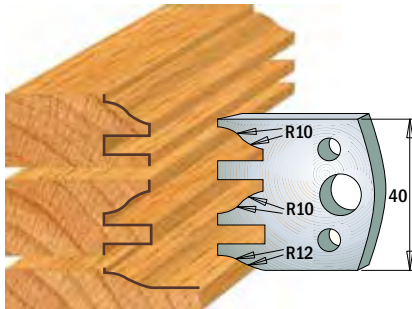

Pair of knives **690.124** **\$16.52**

Cutting length=1-31/32" (50mm) - Thickness=5/32" (4mm)

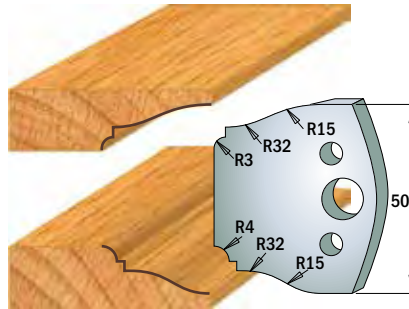

Pair of knives **690.568** **\$30.52**

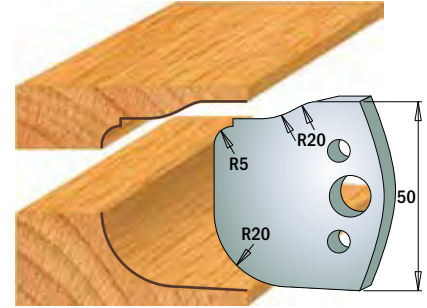

Pair of knives **690.577** **\$30.52**

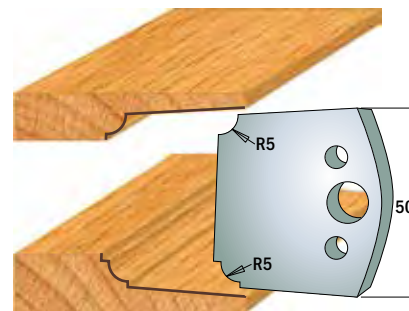

Pair of knives **690.579** **\$30.52**

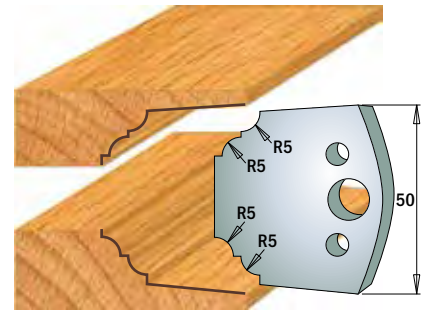

Pair of knives **690.580** **\$30.52**

Drawings are 1:2 scale

Dimension in mm.

Universal Shaper Cutter Heads

TECHNICAL DETAILS:

- Heavy duty aircraft aluminum body.
- Pair of universal straight knives.
- Tools for mechanical feed MEC.
- Pins for the automatic positioning of the knives and the limitors.
- Possibility to use knives with a height of 40mm or 50mm (order no. 690).
- Solid plastic case to fit up to 12 pairs of knives or limitors.

ORDER NO.	D		B		I	RPM	Price
Aluminum body	inches	mm	inches	mm	inches		
692.100.31	4	100	1-1/4	31.75	37/64 or 1-31/32	5500~8400	\$136.92

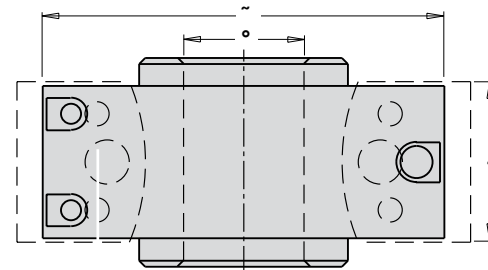

Bore Reducers



699.031.19 — Pair of bore reducer from 1-1/4" to 3/4" — **\$16.31**

CMT Dowel Drills

PART	DESCRIPTION	B	D ₂	D	Shank	I	L	PRICE
302.000.01	Boring Bit Adaptor, Right-Hand Rotation	10 mm	19.5 mm		M10			\$10.19
302.000.02	Boring Bit Adaptor, Left-Hand Rotation	10 mm	19.5 mm		M10			\$10.19
310.050.11	2 Flute Dowel Drills, Right-Hand Rotation			5 mm	10X27	27 mm	57.5 mm	\$10.05
310.050.12	2 Flute Dowel Drills, Left-Hand Rotation			5.1 mm	10X27	27 mm	57.5 mm	\$10.05
310.064.11	2 Flute Dowel Drills, Right-Hand Rotation			1/4"	10X27	27 mm	57.5 mm	\$13.55
310.064.12	2 Flute Dowel Drills, Left-Hand Rotation			1/4"	10X27	27 mm	57.5 mm	\$13.55
310.080.12	2 Flute Dowel Drills, Left-Hand Rotation			5/16"	10X27	27 mm	57.5 mm	\$12.22
310.082.11	2 Flute Dowel Drills, Right-Hand Rotation			8.2 mm	10X27	27 mm	57.5 mm	\$14.35
310.082.12	2 Flute Dowel Drills, Left-Hand Rotation			8.2 mm	10X27	27 mm	57.5 mm	\$14.35
317.350.11	Hinge Boring Bits, Right-Hand Rotation			35 mm	10X26		57.5 mm	\$16.80

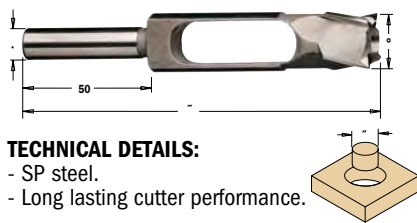
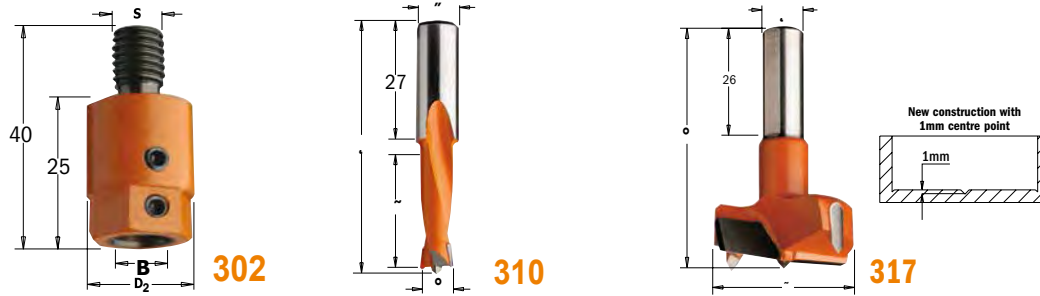

TECHNICAL DETAILS:
 - SP steel.
 - Long lasting cutter performance.

Plug Cutters

PART	DESCRIPTION	d inches	D inches	L inches	S inches	T	Softwood	Hardwood	Max RPM	PRICE
529.095.31	Right-Hand Rotation	3/8	49/64	5-1/2	1/2	4	1000	500		\$11.48
529.127.31	Right-Hand Rotation	1/2	61/64	5-1/2	1/2	4	1000	500		\$14.25
529.158.31	Right-Hand Rotation	5/8	1-7/64	5-1/2	1/2	4	1000	500		\$25.17
529.191.31	Right-Hand Rotation	3/4	1-7/32	5-1/2	1/2	4	500	300		\$25.17
529.254.31	Right-Hand Rotation	1	1-15/32	5-1/2	1/2	5	500	300		\$35.98

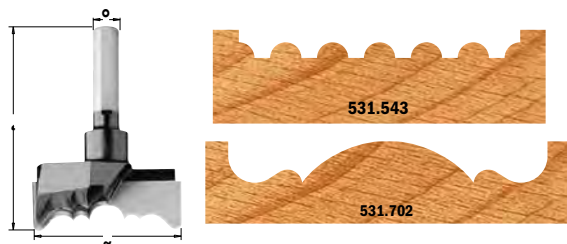

Rosette Cutters

PART	DESCRIPTION	D inches	L inches	S inches	Price
531.543	Right-Hand Rotation	2-1/8	2-21/32	3/8	\$79.24
531.702	Right-Hand Rotation	2-3/4	2-29/32	3/8	\$99.09

TECHNICAL DETAILS:
 - Super strength steel HS.
 - 2 precision ground carbide cutting edges [Z2].
 - Parallel hexagonal shank.
 - Right-hand rotation (RH).



TECHNICAL DETAILS:
 - Super-strength steel SP steel.
 - Precision balanced center point
 - 2 spurs 2.
 - 2 precision ground cutting edges
 - Long lasting cutter performance.

Forstner Bits

PART	DESCRIPTION	D mm	L mm	S mm	Price
537.100.31	Right-Hand Rotation	10	90	8	\$5.78
537.120.31	Right-Hand Rotation	12	90	8	\$6.16
537.140.31	Right-Hand Rotation	14	90	8	\$6.30
537.150.31	Right-Hand Rotation	15	90	8	\$6.51
537.180.31	Right-Hand Rotation	18	90	8	\$7.00
537.200.31	Right-Hand Rotation	20	90	8	\$7.21
537.220.31	Right-Hand Rotation	22	90	8	\$7.93
537.240.31	Right-Hand Rotation	24	90	8	\$7.95
537.250.31	Right-Hand Rotation	25	90	8	\$8.16
537.260.31	Right-Hand Rotation	26	90	8	\$8.75
537.280.31	Right-Hand Rotation	28	90	8	\$9.03
537.300.31	Right-Hand Rotation	30	90	8	\$9.59
537.320.31	Right-Hand Rotation	32	90	10	\$10.68
537.350.31	Right-Hand Rotation	35	90	10	\$11.90
537.400.31	Right-Hand Rotation	40	90	10	\$13.58
537.450.31	Right-Hand Rotation	45	90	10	\$14.74
537.500.31	Right-Hand Rotation	50	90	10	\$17.12
537.550.31	Right-Hand Rotation	55	90	10	\$18.76
537.680.31	Right-Hand Rotation	68	157	12.7	\$32.83

CMT PRO 230.012.08

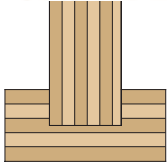

CMT's Dado Pro Set creates clean edges, square shoulders & Flat bottoms.

CMT thoroughly researched the shortcomings of "standard" dado sets and learned what cabinetmakers required most from an "ideal" dado. The result was the Dado Pro Set, designed with the following features:

- Anti-kickback design to reduce the possibility of overfeeding that can occur when cutting mass material.
- Splinter resistant cuts in veneer plywood, melamine and hard and soft woods.
- Five chippers (4x1/8" - 1x1/16") keep the cut flat and virtually free from tear out.
- Shim sets included for cuts between 1/4" and 13/16".
- Ideal for underpowered saws.



Safety Precautions: Always use both outside blades.
Carbide teeth should never come into contact with each other.



Sturdy reusable carrying case.



CMT's Dado Pro Set delivers splinter-resistant cuts in all wood, plywood and wood composites.



Slot width inches	No. Chippers Required	
	1/8"	1/16"
1/4	0	0
5/16	0	1
3/8	1	0
7/16	1	1
1/2	2	0
9/16	2	1
5/8	3	0
11/16	3	0
3/4	4	0
13/16	4	1

Set includes:

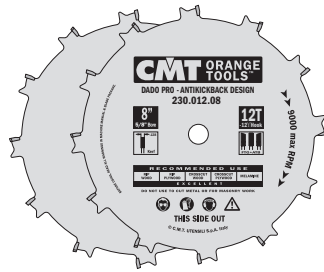

2 BLADES

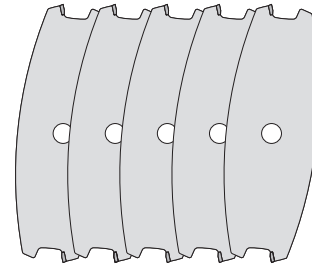

5 CARBIDE TIPPED TWO TOOTH CHIPPERS



STEEL SHIM SET

Shims set contains	
No.	Shim Width
3	0.004
2	0.008
1	0.012
1	0.020

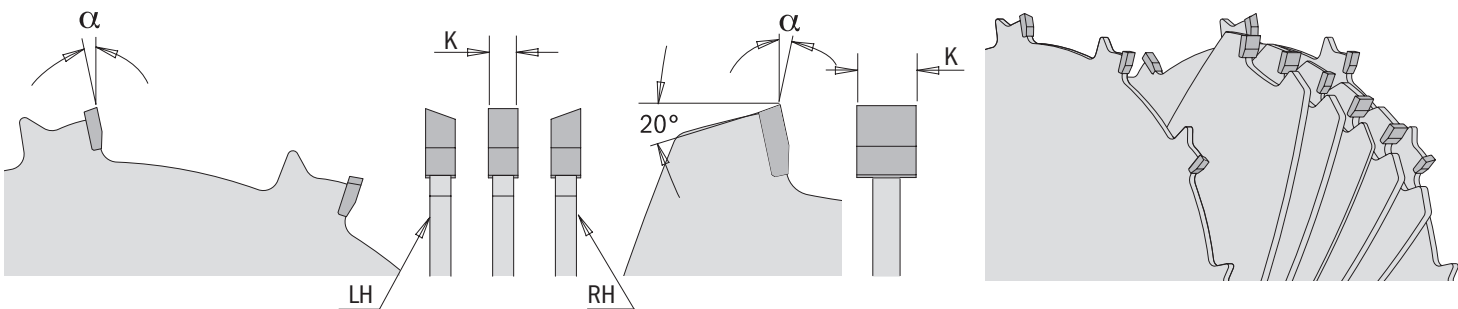

ORDER NO.	D inches	T	B inches	Chippers	Grind	K inches	P inches	Hook Angle	Price
230.012.08	8	12	5/8	4x1/8" x 1x1/16"	FTG+ATB	0.125	0.098	-12°	\$129.71

CMT Precision Dado Sets



CMT's Precision Dado Sets are designed to set a new standard in performance, and they're now available in 6" or 8" diameter. The new 6" dado is perfect for smaller or somewhat underpowered table saws, like the typical 10" contractor saw. Both of these great tools offer features that make them ideal for any cabinetshop, including:

- Anti-kickback design to reduce the possibility of overfeeding that can occur when cutting mass material.
- Splinter-resistant cuts in veneer plywood, melamine and hard or soft woods.
- Four-tooth chippers that keep the cut flat & virtually free from tear out.
- 3/32" chipper made especially for undersized plywood.
- Shim sets included for cuts between 1/4" and 29/32".

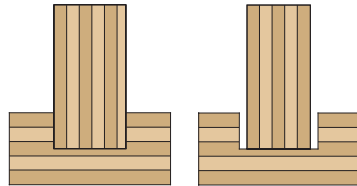

Our special 3/32" chipper lets you adjust for undersized plywood.



Sturdy reusable carrying case for 8" dado.



Sturdy reusable carrying case for 6" dado.



CMT's Dado Pro Set delivers splinter-resistant cuts in all wood, plywood and wood composites.

Slot width inches	No. Chippers Required		
	1/16	3/32	1/8
1/4	0	0	0
5/16	1	0	0
11/32	0	1	0
3/8	0	0	1
13/32	1	1	0
7/16	1	0	1
15/32	0	1	1
1/2	0	0	2
17/32	1	1	1
9/16	1	0	2
19/32	0	1	2
5/8	0	0	3
21/32	1	1	2
11/16	1	0	3
23/32	0	1	3
3/4	0	0	4
25/32	1	1	3
13/16	1	0	4
27/32	0	1	4
29/32	1	1	4

Set includes:

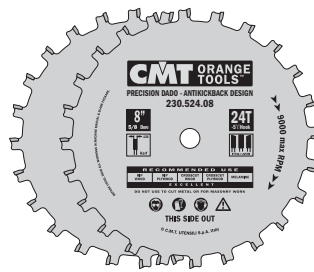

2 BLADES

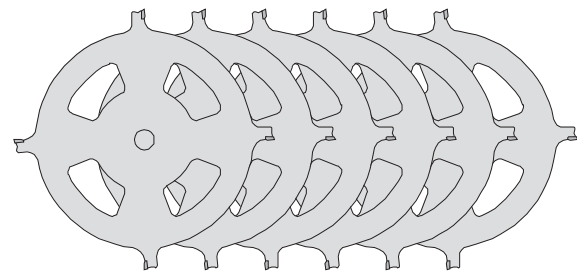

6 CARBIDE TIPPED FOUR TOOTH CHIPPERS.



STEEL SHIM SET

Shims set contains	
No.	Shim Width
4	0.004
2	0.008
2	0.012
2	0.020

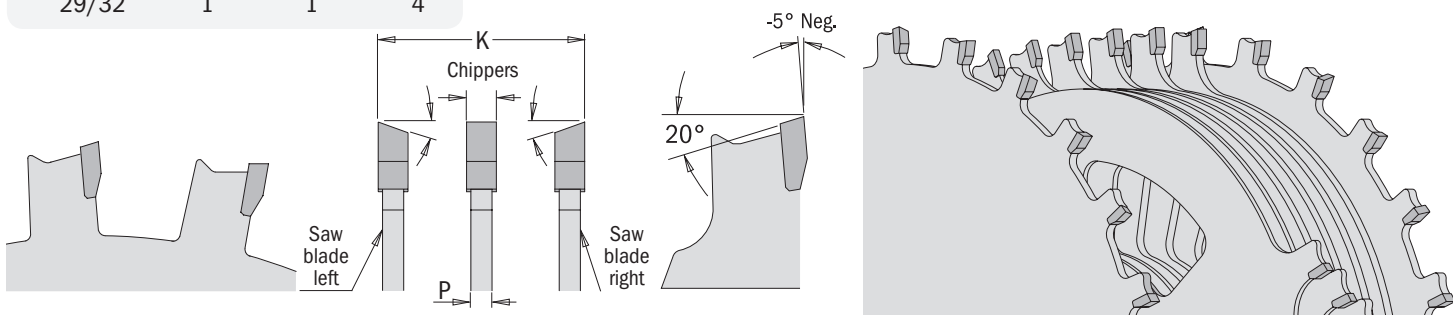

ORDER NO.	D inches	T	B inches	Chippers	β	K inches	P inches	Hook	Price
230.520.06	6	20	5/8	4x1/8", 1x3/32", 1x1/16"	FTG+ATB	0.125	0.098	-5°	\$186.76
230.524.08	8	24	5/8	4x1/8", 1x3/32", 1x1/16"	FTG+ATB	0.125	0.098	-5°	\$222.81



*Ballew Saw and Tools proudly presents
CMT's Bowl and Tray System*



Bowl and Tray System

PART	DESCRIPTION	PRICE
BTS-001	CMT Bowl and Tray system set	\$115.29
TMP-012	Template "American Junior" design, bowl style	\$16.70
TMP-011	Template "American Junior" design, bowl style	\$13.30



Chamfer Bit Set - 5 Pieces - 1/2" Shank

Build beautiful planters, boxes and other multi-sided pieces with this handy set. Why cut imperfect angles on your table saw when it's so much easier to use the CMT Chamfer set. Our solution to accurate polygon construction includes 5 anti-kickback, carbide tipped bits in the most popular angles - **11.25°, 15°, 22.5°, 30° and 45°**. No polygon project is too difficult. Available with **1/2"** shank.

PART	A	D	PRICE
836.501.11	5-Piece Set (listed below)		\$187.70
836.920.11	11.25°	7/8	\$111.42
857.504.11	15°	1	\$29.60
857.503.11	22.5°	1-1/4	\$29.60
857.502.11	30°	1-1/2	\$29.90
857.501.11	45°	1-3/4	\$28.25

Doormaking Templates



These template systems solve the problems of making arched raised panel doors by eliminating the need for high-cost hold-down jigs. Each of our five 20-piece template packages (TMP-001 through TMP-005) includes ten pieces for the panels and the ten corresponding templates for the matching arched rails. Each set has templates for doors from 9-1/2" to 22" wide, and each template is stamped with the door width. All templates are made of rugged HDPE plastic.

TMP-002	Classic Country	Black	\$82.85
----------------	-----------------	-------	---------

Lock Miter Set - 1/2" Shank

PART	D	I	A	T	PRICE
855.505.11	1-15/32	7/8	22.5°	3/8 - 3/4	\$121.00

D- Cutting Diameter **I-** Cutting Length
A- Cutting Angle **T-** Joint Thickness

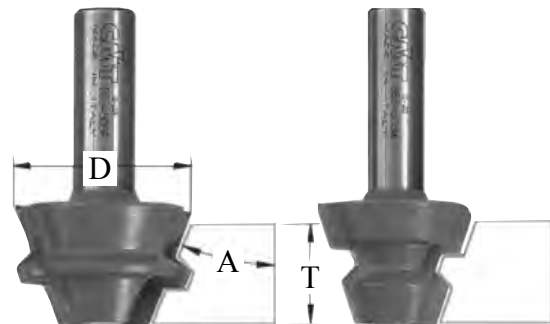

Octagonal shapes are very popular for kitchen corner cabinets, entertainment centers, kitchen islands and corner hutches, but the joints used to be difficult to cut and a nightmare to clamp. Now, CMT's new **22.5° Lock Miter Set** with Carbide Tip provides a fast, accurate way to build a strong, tight **45° joint**. Better still, the lock miter design makes it easy to clamp! This matched pair of cutters makes set-up easy. Height adjustment is not critical - simply adjust your fence so the top edge of the work piece intersects the angle of the bit where it meets the fence. After your joints are machined they can be glued and assembled and simply clamped by using strapping tape.

CMT

Window Sill Bits - 1/2" Shank

PART	R	R1	D	I	PRICE
855.804.11	7/32	3/8	1-1/4	1	\$49.40
855.805.11	3/8	1/2	1-1/2	1/3-8	\$62.90

D- Cutting Diameter **I-** Cutting Length
R- Cutting Radius **R1-** Cutting Radius



These profiles were originally intended for shaping the edges of window sills. Now these bits are also used for creating finger pulls on the edges of doors and drawers. This profile is available in a small and large version for 5/8" to 3/4" or 1" to 1-1/8" material thicknesses. Recommended for router table use only.

Window Sill Bits - 1/2" Shank

PART	R	R1	D	I	PRICE
855.804.11B	7/32	3/8	1-1/4	1	\$59.90
855.805.11B	3/8	1/2	1-1/2	1/3-8	\$74.90

D- Cutting Diameter **I-** Cutting Length
R- Cutting Radius **R1-** Cutting Radius



Spare Parts:	
791.015.00	1-1/4" shield
791.020.00	1-1/2" bearing
541.002.00	Stop collar for 1/2" shanks
991.056.00	1.5mm key hex for stop collars

A top carbide tipped bearing makes the Window Sill bit even more versatile. Use them to follow patterns to create curved sills, molded edges on doors or almost any part that requires an attractive edge. Recommended for router table use only.

Finger Joint Bit - 1/2" Shank

PART	D	H	A	T	PRICE
800.616.11	1-7/9	3/8	1-1/8	1/2 - 1-9/16	\$97.90

D- Cutting Diameter **H-** Cutting Depth
B- Bearing Diameter **T-** Joint Thickness

Spare Parts:	
822.340.11	5/32" three-flutes slot cutter
824.130.11	1/2" arbor
791.027.00	1-1/8" bearing
541.515.00	0.1mm spacer
541.519.00	5.8mm spacer
990.020.00	nut for arbor, M8 thread

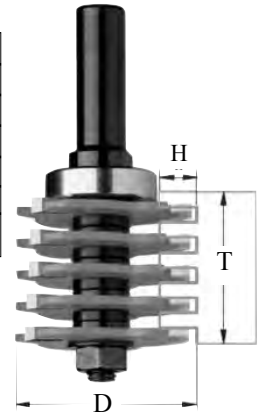

This bit allows you to cut accurate and functional finger joints with ease. Simply adjusting the height of the bit allows you to cut joints in a number of different stock thicknesses, as indicated in the drawing below. The bearing cuts joints that are 3/8" deep, for other joint depths just move the fence inward.

Tenon Cutting Router Bit Set - 1/2" Shank

PART	I	D	H	L	PRICE
800.627.11	1-3/8	2-61/64	1-1/16	3-5/16	\$89.99

D- Cutting Diameter **H-** Cutting Depth
I- Bearing Diameter **L-** Joint Thickness

If you've struggled cutting tenons that fit, here's the perfect solution for precise tenons. CMT's new tenon cutting router bit will produce perfectly fitting tenons in every board you cut, even if the boards vary slightly in thickness. Simply set the distance between the cutters using the included spacers, and you can easily cut tenons from 3/16-in. to 3/8-in. thick, up to 1-1/16-in. long. This simple-to-use router bit takes the mystery out of achieving the excellent tenon-to-mortise fit required for high quality joinery.



Spare Parts:	
824.134.00	Arbor 1/2" shank
822.020.11	Slot Cutter 1/4"
541.521.00	Spacer 1/16"
541.522.00	Spacer 1/8"
541.523.00	Spacer 1/4"
541.513.00	Spacer 0.1mm
541.520.00	Spacer 0.3mm
990.022.00	Nut for arbor, M12x1.25mm

Instructional DVD included in every set.



Safety Precautions: -Maximum speed: 12,000 rpm. -Use in Router table only.

CMT

3 Piece Entry and Interior Door Router Bit Set 1/2" Shank

PART	DESCRIPTION	I	D	T	L	B	PRICE
800.527.11	3 Piece Set (shown at right)						\$275.50
800.628.11*	Tenon Cutting Router Bit Set	1-3/4	3	1-3/8 to 1-3/4	4	--	\$129.08

D- Cutting Diameter T- Stock Thickness B- Bearing (mm)
 I- Cutting Length L- Overall Length (inches)

*: Tenon cutting router bit **800.628.11** is a patent Pending of C.M.T. Utensils S.P.A.

The new CMT three-piece set simplifies door construction, making it easy as 1, 2, 3! It is not the only advantage in fact this is a multi functional set for door makers and furniture makers building entry doors, passage doors and any furniture tenons. The included tenon cutter produces a beefy 1-1/16" long tenon. Coupled with the cope cutter, you can produce long and strong tenons with minimum set up. As an extra bonus the tenon cutter can be used for furniture making work that require any tenon from 3/16" to 5/8" thick. Router table only.



3 Piece Raised Panel Sets with Backcutter - 1/2" Shank

PART	DESCRIPTION	I	D	R	L	B	PRICE
800.517.11	3 Piece Cove Raised Panel Set (891.527.11, 891.501.11, shown below)						\$171.98
800.521.11	3 Piece Ogee Raised Panel Set (891.524.11, 891.501.11)						\$173.50
890.524.11	Ogee raised panel w/ backcutter	1-1/8	3-1/2	15/16	3-1/16	1-1/4, 16mm	\$82.75

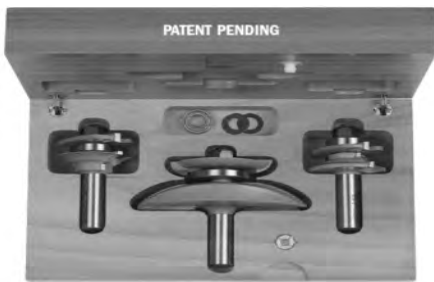

D- Cutting Diameter R- Cutting Radius B- Bearing (inches)
 I- Cutting Length L- Overall Length (inches)

If your project calls for top quality raised panel doors, milled with accuracy and efficiency, then this set is a great choice. The ogee rail and stile bits are made to exact specifications to match perfectly, and the stile cutter is designed with a shear angle to produce superior cuts with minimal splintering. The raised panel bit is available with either cove or ogee profiles. Both bits include a back cutter which allows milling of the front and back of the panel in a single pass.

Formula 2050

PART#	DESCRIPTION	PRICE
998.001.01	Formula 2050 Blade and Bit Cleaner (18oz Bottle)	\$9.99

- Removes pitch, resin and adhesive residue from all woodworking cutting tools (saw blades, router bits, drill bits, shaper cutters, planer blades, etc.).
- Completely non-toxic, non-flammable and certified biodegradable. Formula 2050 is a safe, earth-friendly product.
- Do not rinse after cleaning. Formula 2050 provides protection from rust and corrosion. Keeps your table saw top rust free too!
- Can be applied by spray bottle or used in ultrasonic cleaners and dip tanks.

★ ★ ★ ★ ★

This product received a five-star performance rating from "Wood® Magazine"



CMT 3 Piece Raised Junior Panel Sets with Backcutter - 1/2" Shank

PART	DESCRIPTION	I	D	R	B	PRICE
890.537.11	Cove junior raised panel w/back cutter	2-1/2	11/16	3/4	16	\$96.40
891.517.11	Ogee junior rail and stile bits	1-1/4	11/16	1/8 - 3/16	16	\$88.00
890.534.11	Ogee junior raised panel w/back cutter	2-1/2	11/16	1/2	16	\$75.50
800.518.11	3 Piece Cove Junior Raised Panel Set (890.537.11, 891.517.11, shown below)					\$159.55
800.522.11	3 Piece Ogee Junior Raised Panel Set (890.534.11, 891.517.11)					\$165.50

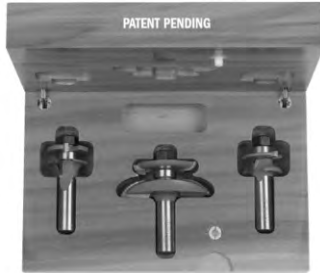

D- Cutting Diameter **R-** Cutting Radius
B- Bearing (mm) **I-** Cutting Length

CMT's Junior Raised Panel Sets add intricate detail on a whole new scale! The Junior Raised Panel Set lets you make frame and panel details as small as 2-3/4" square in material as thin as 7/16". Delicate panel doors are only the beginning - use these bits with templates to add interesting arches to your work. The set includes your choice of a Cove or Ogee Raised Panel Bit and an Ogee Rail and Stile pair. Packaged in a beautiful hardwood case.

3 Piece Kitchen Sets

PART	DESCRIPTION	D	I	T	L	B	PRICE
800.513.11	Ogee Kitchen Set						\$127.75
890.504.11	Ogee raised panel bit	3-1/4	19/32	23/32 to 25/32	2-1/2	1/2	\$90.70
890.501.11	Ogee rail and stile bits	1-3/4	19/32	23/32 to 7/8	2-51/64	22mm	\$59.95
800.512.11	Standard Kitchen Set						\$127.75
890.505.11	Standard raised panel bit	3-1/2	19/32	23/32 to 25/32	2-1/2	1/2	\$90.70
890.502.11	Standard rail and stile bits	1-3/4	19/32	23/32 to 7/8	2-51/64	22mm	\$80.01
800.514.11	Bevel and Radius Kitchen Set						\$127.75
890.506.11	Bevel and radius raised panel bit	3-1/2	19/32	23/32 to 25/32	2-1/2	1/2	\$84.63
890.503.11	Bevel and radius rail and stile bits	1-3/4	19/32	23/32 to 7/8	2-51/64	22mm	\$85.70
800.516.11	Cove Kitchen Set						\$174.00
890.507.11	Cove raised panel bit	3-1/2	19/32	23/32 to 25/32	2-1/2	1/2	\$84.63
890.502.11	Standard rail and stile bits	1-3/4	19/32	23/32 to 7/8	2-51/64	22mm	\$80.01

D- Cutting Diameter **T-** Stock Thickness
I- Cutting Length **L-** Overall Length
B- Bearing (inches)

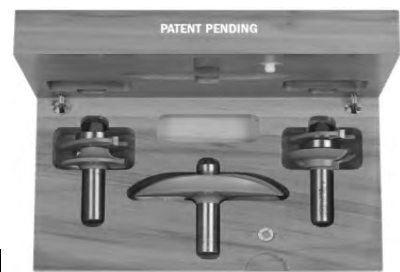

3 Piece Glass Panel Set - 1/2" Shank

PART	DESCRIPTION	D	I	R	L	B	PRICE
855.803.11	3 Piece Glass Panel Set						\$107.20
822.016.11B	1/8" Slot Cutter	2-1/8	1/8	--	2-13/64	3/4	\$35.35

D- Cutting Diameter **I-** Cutting Length
R- Cutting Radius **L-** Overall Length **B-** Bearing (inches)

CMT's unique stile and rail set allows you to produce glass panel doors using a rubber panel retainer to secure the glass in a 1/8" slot cut into the frames. These 1/2" shank bits work the same as our other stile and rail sets, but leave you with a square rabbet on the inside of your door for installing the glass panel.

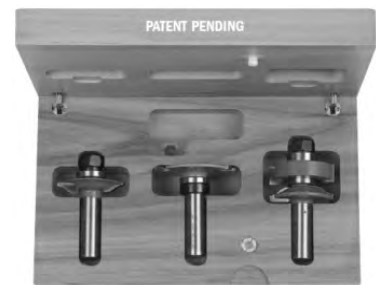

122 CMT Distributed through **Ballew Saw & Tool, Inc.**

CMT

3 Piece *Lonnie Bird* Divided Light Door Set
1/2" Shank

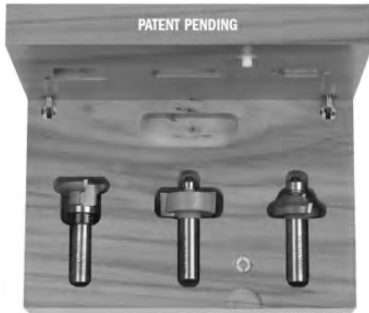

PART	DESCRIPTION	D	I	R	H	B	PRICE
800.525.11	3 Piece Lonnie Bird Divided Light Door Set						\$120.50
835.850.11	Rabbeting bit	1-3/8	1/2	--	3/8	3/8	\$25.99
855.802.11	Rail and stile bits	1-1/4	1/2	1/4	--	1/2, 3/4	\$100.00

D- Cutting Diameter I- Cutting Length
R- Cutting Radius H- Overall Length B- Bearing (inches)

Build authentic divided light doors for fine furniture and cabinets with this 3-piece set. The set includes a stick bit to cut the decorative ovolo profile on the frame edges, a cope bit which shapes the mating profile on the ends of the stock, and a rabbeting bit for cutting the recess for the glass. Because the bits have guide bearings you can also create arched or curved frames. The unique design of the cope bit allows you to use full-length tenons to create strong, authentic mortise-and-tenon joinery. As the stock is coped, the tenon passes over the bit. The set is designed for 7/8" wide bars such as those on a corner cupboard door. Instructions included.

NOTE: You will need to produce mortise and tenon joints with a tenoning jig or other tools.

7 Piece *Lonnie Bird* Crown Molding Set
1/2" Shank - 5/8" Arbor

PART	DESCRIPTION	PRICE
800.523.11	7 Piece Lonnie Bird Crown Molding Set (listed below)	\$391.20
867.501.11B	Inverted roman ogee profile - 5/32" radius	\$40.10
867.502.11B	Inverted roman ogee profile - 5/32" radius	\$50.00
867.503.11B	Inverted roman ogee profile - 1/4" radius	\$67.40
867.601.11B	Inverted roundover profile - 1/4" radius	\$37.90
867.602.11B	Inverted roundover profile - 5/16" radius	\$42.80
867.603.11B	Inverted roundover profile - 3/8" radius	\$38.80
235.006.07	Cove cutter head - 7" diameter, 5/8" arbor, 6 carbide teeth x radius	\$153.30



This set lets you make crown molding that surpasses anything you'll find at the lumberyard, and crown molding is just the beginning! By arranging the profiles of the six router bits in various combinations you can create dozens - or hundreds - of different decorative profiles! The set consists of a 7" diameter, 5/8" arbor cove cutter for your table saw, and six 1/2" shank carbide tipped router bits. All six bits - three ogees and three roundovers - feature CMT's unique inverted design. Why use inverted profiles? Because the flat face of your workpiece always remains in firm contact with your router table for unprecedented accuracy and control.

Interchangeable Bushings

PART	D	PIECES	PRICE
03.51.0047A	1/4	20	\$3.00
03.51.0049A	1/2	20	\$3.00

Bit Organizer (without bushings)

Part Number	PRICE
03.51.0106	\$12.25

When you are constantly working on projects, you always need your most used bits right on hand and safely organized. CMT gives you the perfect solution for keeping it all in sight and within reach with our 100 piece organizer.

Conveniently holds any size router or drill bit by using our interchangeable bushings to fit all CMT shank diameters. See options listed below.



CMT

Cove Cutter Head A

PART	PRICE
235.006.07	\$153.30

Collars for Top Bearing Bits B

PART	SHANK DIA.	PRICE
541.002.00	1/2	\$4.50

Conical Delrin® Bearings D

PART	D	b	T	PRICE
791.041.00	3/4	3/16	6,8mm	\$11.60
791.043.00	3/4	3/16	7mm	\$7.07

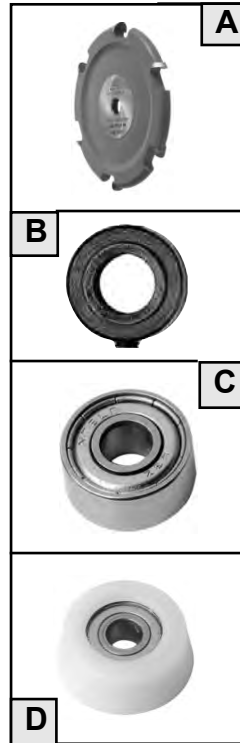

Bearings C

PART	D	b	T	PRICE
791.005.00	22mm	8mm	7mm	\$3.99
791.011.00	3/4	1/2	4mm	\$5.95
791.025.00	16mm	8mm	5mm	\$4.87

Bearings E

PART	D	b	T	PRICE
791.703.00	3/4	1/2	4mm	\$25.95



Slot Cutter

PART	Dia	SHANK	PRICE
822.016.11B	2-1/8"	1/2"	\$45.92



Glass Panel Retainers

Order No. **GLAS/RTBRN** 25' roll **\$18.69**



Our unique retainer strips fit perfectly in the 1/8" slot created by the slot cutter bit, and hold your glass securely in the frame. Sold in 25' lengths.

Digital Height Gauge

TECHNICAL DETAILS :

- Measuring range: Scale: 0~80mm (0~3")
Needle: 0~50mm (0~2").
- Resolution: 0.05mm/0.002".
- Accuracy: ±0.1mm (±0.004").
- Power: CR2032 3V - 1500 hours.

ORDER NO.	DESCRIPTION	Price
DHG-001	Digital height gauge	\$21.56



796 Collet chuck

ORDER NO.	DESCRIPTION	Price
1/2" shank		
796.001.00	Router collet extension with 1/2" collet	\$38.89



990 Screw for bearing

NR. #	d x l x L mm	D mm	TYPE	Price
990.058.00	1/8"x3/8"x1/2"	7	12_TCEI	\$1.40

CMT Straight and Profile
800.001.00

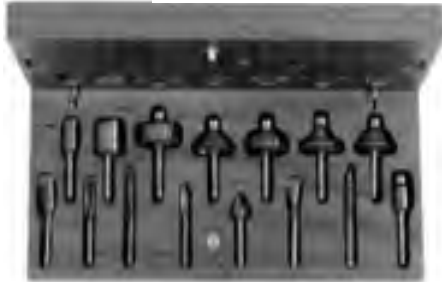

Complete Kitchen Set
800.509.11



Dovetail Straight Bit Set
800.519.11



**Lonnie Bird's
Crown Molding Bit Set**
800.523.11



More ROUTER BIT SETS

More Router Bit Sets

CMT's beautiful sets are the perfect companions for the professional craftsman. This set offers a selection of organized and ready-to-use straight and profile bits, added value for any woodworker! Each bit included is made of Fatigue Proof® steel, micrograin carbide and is coated with orange non-stick PTFE.

PART	SET DESCRIPTION	PIECES	SHANK	PRICE
800.001.00	Straight and Profile	15	1/2	\$198.95
800.500.11	Dovetail and Straight	8	1/4	\$97.25
800.501.11	Dovetail and Straight	8	1/2	\$112.75
800.503.11	Straight and Profile	12	1/4	\$165.75
800.504.11	Profile	6	1/2	\$113.50
800.505.11	Straight and Profile	13	1/2	\$206.95
800.509.11	Complete Kitchen - Profile A	5	1/4	\$237.50
800.510.11	Complete Kitchen - Profile B	5	1/4	\$245.50
800.511.11	Complete Kitchen - Profile C	12	1/4	\$219.50
800.512.11	Kitchen - Profile B2	3	1/2	\$127.75
800.513.11	Kitchen Set - Profile A2	3	1/2	\$127.75
800.514.11	Kitchen Set - Profile C2	3	1/2	\$127.75
800.515.11	Cabinet Making - Profile A	6	1/2	\$279.95
800.518.11	Junior Raised Panel - Profile A	3	1/2	\$159.55
800.519.11	Dovetail Straight Bit	13	1/2	\$169.98
800.520.11	Cabinet Making - Profile B	6	1/2	\$260.50
800.521.11	Cabinet Making - Profile B	3	1/2	\$173.25
800.522.11	Junior Raised Panel - Profile B	3	1/2	\$165.50
800.524.11	Lonnie Bird's Small Arch Door	3	1/2	\$138.80
800.527.11	Entry and Interior Router Bit	3	1/2	\$275.50
800.626.11	Tongue and Groove	2	1/2	\$54.00
823.001.11	Slot Cutter Bit w/ Chucks	15	1/2	\$177.50
835.001.11	Rabbeting bit - 1/2" Cutting Length	7	1/4	\$36.50
835.501.11	Rabbeting bit - 1/2" Cutting Length	7	1/2	\$38.50
835.502.11	Rabbeting bit - 3/4" Cutting Length	7	1/2	\$42.95
835.503.11	CMT Grand Rabbet	18	1/2	\$99.10
836.501.11	Chamfer Bit	5	1/2	\$112.75
838.501.11	Roundover	3	1/2	\$57.12
855.701.11	Flute And Bead Bit	2	1/2	\$73.50
855.803.11	Glass Panel	3	1/2	\$107.20
891.501.11	Rail and Stile - Profile A	2	1/2	\$105.95
891.502.11	Rail and Stile - Profile B	2	1/2	\$97.25
891.512.11	Lonnie Bird's Rail and Stile	2	1/2	\$81.98

Chamfer Bit Set
836.501.11



CMT Router Bits

PART	DESCRIPTION	D	I	L	S	A	R	R1	T	PRICE
801.127.11	Mortising Bits	1/2	3/4	2-1/8	1/4	--	--	--	--	\$16.52
801.158.11	Mortising Bits	5/8	3/4	2-1/4	1/4	--	--	--	--	\$17.19
801.190.11	Mortising Bits	3/4	3/4	2-1/8	1/4	--	--	--	--	\$17.96
801.127.11B	Mortising w/ Bearing	1/2	3/4	2-1/8	1/4	--	--	--	--	\$17.00
801.158.11B	Mortising w/ Bearing	5/8	3/4	2-1/4	1/4	--	--	--	--	\$19.50
801.190.11B	Mortising w/ Bearing	3/4	3/4	2-1/8	1/4	--	--	--	--	\$15.75
801.817.11B	Mortising w/ Bearing	1-1/4	1/2	2-1/8	1/2	--	--	--	--	\$19.50
801.818.11B	Mortising w/ Bearing	1-1/4	15/64	2-31/64	1/2	--	--	--	--	\$28.30
812.032.11	Weatherseal	1/8	1/2	2	1/4	--	--	--	--	\$13.50
822.340.11A	Slot Cutter	5/32	1-7/8	1/2	1/4	--	--	--	--	\$22.50
822.340.11B	Slot Cutter	5/32	1-7/8	1/2	1/2	--	--	--	--	\$21.25
836.190.11	Chamfer	7/8	13/32	--	1/4	25°	--	--	--	\$24.50
837.955.11	Cove	2	1/2	--	1/2	--	--	--	--	\$37.52
846.825.11	Ogee Fillet	--	--	--	--	--	--	--	--	\$22.10
850.001.11	Keyhole (Minor Dia. 3/16)	3/8	7/16	--	1/4	--	--	--	--	\$17.99
852.001.11	Dado and Planer	3/4	3/8	2-1/4	1/4	--	--	--	--	\$22.30
852.001.11B	Dado and Planer	3/4	3/8	2-1/4	1/4	--	--	--	--	\$25.00
852.501.11B	Dado and Planer	3/4	3/8	2-1/2	1/2	--	--	--	--	\$25.25
852.503.11B	Dado and Planer	1-1/4	5/8	2-3/4	1/2	--	--	--	--	\$33.50
852.504.11B	Dado and Planer	1-1/2	5/8	2-3/4	1/2	--	--	--	--	\$37.90
855.505.11	Lock Miter	1-15/32	7/8	--	1/2	22.5°	--	--	3/8 -3/4	\$121.00
858.001.11	Laser Point	1/2	7/16	2-1/4	1/4	60°	--	--	--	\$24.95
858.501.11	Laser Point	1/2	7/16	2-3/8	1/2	60°	--	--	--	\$28.77
859.564.11	Ogee	1-1/2	3/4	--	1/2	--	1/4	--	--	\$37.40
863.580.11	Cavetto Edge Mold	1-1/4	9/16	--	1/2	--	5/16	--	--	\$37.90
865.402.11	Decorative Beading Bits	25/64	25/64	1-31/32	1/4	--	13/64	--	--	\$24.12
880.571.11	Solid Surface Sink & Trim Bits	3/4	1	3-1/16	1/2	--	--	--	--	\$34.93
890.501.11	Horizontal Raised Panel - A	3-1/4	19/32	--	1/2	--	--	--	23/32	\$59.95
890.506.11	Horizontal Raised Panel - C3	3-1/2	19/32	--	1/2	--	--	--	25/32	\$84.63
890.512.11	Horizontal Raised Panel - B3	1-7/8	3/8	--	1/2	--	--	--	19/32	\$62.10
890.524.11*	Horizontal Raised Panel - A	3-1/2	--	--	1/2	--	--	--	3/4-13/16	\$82.75
890.527.11*	Horizontal Raised Panel - B	3-1/2	--	--	1/2	--	--	--	3/4-1	\$109.99
890.534.11*	Horizontal Raised Panel - A1	2-1/2	--	--	1/2	--	--	--	7/16-11/16	\$75.50
890.537.11*	Horizontal Raised Panel - B1	2-1/2	--	--	1/2	--	--	--	7/16-11/16	\$89.99



Systems and Accessories

ITEM	DESCRIPTION	SIZE	PRICE
RCS-CUT	3D router spare bit	shank diameter 12,7mm (1/2")	\$26.18
RCS-BIT	3D router carver bit and sleeve	shank diameter 12,7mm (1/2")	\$95.50
CMT792	Magnetic knife Setting Jigs		\$74.30



CMT Router Bits Sets

PART	DESCRIPTION	D	I	L	Shank	T ₁	A	R	H	P	PRICE
806.690.11	Super-Duty Flush Trim Bits	3/4	2	4-5/16	1/2"						\$32.97
807.128.11	3 in1 Flush Trim Bit for MDF/Laminate	1/2	1/2	2-9/64	1/4"						\$17.68
807.190.11	3 in1 Flush Trim Bit for MDF/Laminate	5/8	3/4	2-11/32	1/4"						\$22.30
807.690.11	3 in1 Flush Trim Bit for MDF/Laminate	3/4	5/8	2-19/32	1/2"						\$22.65
814.127.11B	Round Nose Bits	1/2	3/8	2	1/4"			1/4			\$25.97
814.160.11B	Round Nose Bits	5/8	3/8	2	1/4"			5/16			\$27.20
814.190.11B	Round Nose Bits	3/4	7/16	2	1/4"			3/8			\$28.70
814.690.11B	Round Nose Bits	3/4	1-1/4	2-7/8	1/2"			3/8			\$45.43
823.364.11B		1-7/8	1/4	2-25/64	1/2"				1/2	0.175"	\$28.77
823.332.11B	Slot Cutter with Arbor & Bearing	1-7/8	1/8	2-17/64	1/2"				1/2	0.05"	\$27.34
835.990.11	Rabbeting bit	2	7/8	3-5/64	1/2"				5/8		\$59.78
836.420.11	Chamfer Bits	1-49/64	23/32	2-3/8	1/4"		45°				\$31.15
837.254.11	Cove Bits	1-1/8	1/2	2-1/8	1/4"			5/16			\$28.42
837.690.11	Cove Bits	7/8	1/2	2-13/32	1/2"			3/16			\$27.27
837.754.11	Cove Bits	1-1/8	1/2	2-3/8	1/2"			5/16			\$29.51
837.955.11	Cove Bits	2	1/2	2-27/64	1/2"						\$40.39
840.270.11	Roman Ogee Bits	1-1/8	29/64		1/4"			5/32			\$30.24
840.350.11	Roman Ogee Bits	1-1/2	11/16		1/4"			1/4			\$34.69
840.770.11	Roman Ogee Bits	1-1/8	29/64		1/2"			5/32			\$31.75
840.850.11	Roman Ogee Bits	1-1/2	11/16		1/2"			1/4			\$39.31
850.501.11	Keyhole Bits	3/8	7/16	2-19/32	1/2"						\$27.06
851.001.11	Bowl & Tray Bits	7/16	1/2	1-51/64	1/4"				1/8		\$25.45
851.502.11	Bowl & Tray Bits	1-1/4	5/8	2-3/8	1/2"				1/4		\$40.18
851.502.11B	Bowl & Tray Bits	1-1/4	5/8	2-3/8	1/2"				1/4		\$45.15
852.501.11	Dado & Planer Bits	3/4	3/8	2-1/2	1/2"						\$22.30
852.502.11	Dado & Planer Bits	1	3/8	2-1/4	1/2"						\$20.93
852.503.11	Dado & Planer Bits	1-1/4	5/8	2-3/4	1/2"						\$29.51
852.504.11	Dado & Planer Bits	1-1/2	5/8	2-3/4	1/2"						\$29.79
855.502.11	Drawer Lock Bits	2	1/2	2	1/2"	5/8-1					\$45.15
855.504.11	Lock Miter Bits	2	7/8	2-3/8	1/2"	3/8-3/4	45°				\$86.45
855.506.11	V-Tongue & Groove Set	1-3/4	5/8	2-63/64	1/2"	3/4-1	90°				\$169.09



811.501.11 3 piece Plywood Groove Set **1/2" shank** \$56.25

Set contains	ORDER NO. 1/2" shank	D	I
		inches	mm
Straight bit	● 811.560.11	15/64	6
Straight bit	811.623.11	31/64	12.3
Straight bit	811.682.11	23/32	18.2



835.503.11 CMT Grand Rabbet Set **1/2" shank** \$136.29

Set contains	Order No.	H	D	I
		inches	mm	inches
Rabbeting bit	835.990.11	5/8	15.87	2

- 791.705.00 5 pcs. collar set (1/16" - 1/8" - 1/4" - 3/8" - 1/2" rabbets)
- 791.706.00 5 pcs. collar set (3/16" - 5/16" - 7/16" - 9/16" - 11/16" rabbets)
- 791.707.00 5 pcs. collar set (15/64" - 23/64" - 15/32" - 19/32" - 23/32" rabbets)
- 799.517.00 2" collar for Flush Trim

CMT CIRCULAR SAW BLADES

Industrial Ripping Blades								
Part #	Diameter	Teeth	Bore	Grind	Kerf	Plate	Hook Angle	Price
201.024.10	10"	24	5/8"	FTG	0.126	0.087	20°	\$54.60

Industrial Glue Line Ripping								
Part #	Diameter	Teeth	Bore	Grind	Kerf	Plate	Hook Angle	Price
203.030.10	10"	30	5/8"	TCG	0.126	0.087	12°	\$55.30
203.036.12	12"	36	1"	TCG	0.165	0.110	12°	\$72.73

Industrial General Purpose Blades								
Part #	Diameter	Teeth	Bore	Grind	Kerf	Plate	Hook Angle	Price
213.040.10	10"	40	5/8"	20° ATB	0.126	0.098	18°	\$61.67
214.040.10	10"	40	5/8"	20° ATB	0.102	0.071	18°	\$53.90

Industrial Sliding Compound Miter & Radial Blades								
Part #	Diameter	Teeth	Bore	Grind	Kerf	Plate	Hook Angle	Price
219.080.10	10"	80	5/8"	4/30°ATB U#8	0.118	0.098	-5°	\$90.93
219.090.12	12"	90	1"	4/30°ATB U#8	0.118	0.098	-5°	\$115.71
219.100.14	14"	100	1"	4/30°ATB U#8	0.118	0.098	-5°	\$133.00
219.100.15	15"	100	1"	4/30°ATB U#8	0.118	0.098	-5°	\$137.90

Industrial Combination Blades								
Part #	Diameter	Teeth	Bore	Grind	Kerf	Plate	Hook Angle	Price
215.050.10	10"	50	5/8"	4ATB U#8	0.126	0.087	12°	\$64.12

Industrial Melamine & Fine Cut-Off Blades								
Part #	Diameter	Teeth	Bore	Grind	Kerf	Plate	Hook Angle	Price
210.080.10	10"	80	5/8"	38° ATB	0.126	0.087	2°	\$90.30
210.096.12	12"	96	1"	38° ATB	0.126	0.087	2°	\$118.30

Industrial XTreme plexiglass and plastic circular saw blades								
Part #	Diameter	Teeth	Bore	Grind	Kerf	Plate	Hook Angle	Price
222.080.10	10"	80	5/8"	MATB	0.110	0.087	-3°	\$82.92

Box & Finger Joint Blade

Part #	Diameter	Teeth	Bore	Grind	Kerf	Plate	Hook Angle	Price
230.224.01	8"	24	5/8"	FTG	0.250	0.125	15°	\$69.90

Industrial Melamine & Fine Cut-Off Blades

Part #	Diameter	Teeth	Bore	Grind	Kerf	Plate	Hook Angle	Price
281.060.10	10"	60	5/8"	TCG	0.126	0.087	10°	\$62.93
281.072.12	12"	72	1"	TCG	0.126	0.087	10°	\$83.30

ITK Combination Blade

Part #	Diameter	Teeth	Bore	Grind	Kerf	Plate	Hook Angle	Price
256.050.10	10"	50	5/8"	4/20°ATB FTG	0.098	0.071	15°	\$45.15

Industrial Dry Cut Steel Blades

Part #	Diameter	Teeth	Bore	Grind	Kerf	Plate	Hook Angle	Price
226.048.07	7-1/4"	48	5/8"	TCG	0.079	0.063	0°	\$62.30
226.048.10	10"	48	5/8"	8° FWF	0.087	0.071	0°	\$69.09
226.072.14	14"	72	1"	8° FWF	0.087	0.071	0°	\$122.43

Biscuit Joiner Blade

Part #	Diameter	Teeth	Bore	Grind	Kerf	Plate	Hook Angle	Price
240.006.04	4"	6	22mm 4/4, 5-9	ATB	0.157	0.122	18°	\$18.20
240.008.04	4"	8	22mm 5/36	ATB	0.157	0.122	18°	\$21.21

Industrial Non-Ferrous Metal, PVC & Melamine Blades

Part #	Diameter	Teeth	Bore	Grind	Kerf	Plate	Hook Angle	Price
225.080.10	10"	80	5/8"	TCG	0.122	0.098	-7°	\$80.50
225.096.12	12"	96	1"	TCG	0.122	0.098	-7°	\$104.30

Industrial Heavy-Duty General Purpose Blades

Part #	Diameter	Teeth	Bore	Grind	Kerf	Plate	Hook Angle	Price
285.040.10	10"	40	5/8"	30°HiATB	0.126	0.098	12°	\$67.13
285.048.12	12"	48	1"	30°HiATB	0.126	0.098	12°	\$88.13

Saw Blade Stabilizers

Part #	Diameter	Bore	Price
299.101.00	3"	5/8"	\$18.62



ComSurge Tooling, Inc.

Solid Carbide Brad Point Drill Bits

Item Number Right Hand	Item Number Left Hand	Diameter	Overall Length	Price
S020DSR	S020DSL	2.0 mm	55 mm	\$ 9.45
S024DSR	S024DSL	2.4 mm	55 mm	\$ 10.15
S025DSR	S025DSL	2.5 mm	55 mm	\$ 10.15
S028DSR	S028DSL	2.8 mm	55 mm	\$ 10.15
S030DSR	S030DSL	3.0 mm	55 mm	\$ 10.85
S032DSR	S032DSL	3.2 mm	55 mm	\$ 10.85
S035DSR	S035DSL	3.5 mm	55 mm	\$ 12.11
S040DSR	S040DSL	4.0 mm	55 mm	\$ 12.53
S050DSR	S050DSL	5.0 mm	55 mm	\$ 16.45
S060DSR	S060DSL	6.0 mm	55 mm	\$ 20.30



Solid Carbide V-Point Drill Bits

Item Number Right Hand	Item Number Left Hand	Diameter	Overall Length	Price
S030AVR	N/A	3.0 mm	45 mm	\$ 8.33
S030VSR	S030VSL	3.0 mm	55 mm	\$ 13.93
S030HVR	S030HVL	3.0 mm	70 mm	\$ 8.33
S032VSR	S032VSL	3.2 mm	55 mm	\$ 13.93
S032HSR	S032HSL	3.2 mm	70 mm	\$ 12.53



Metric Boring Bit Adapter - Converts into Carbide

Item Number	Inside Diameter	Shank		Price
HS005-62484	10 mm	1/2	3"	\$19.53





ComSurge Tooling, Inc.

Adapter - Metric Drill Chuck 10 mm X 19 mm Shank

Item Number	Diameter	Shank mm	Price
TA35020	2.0 mm	10 mm X 19 mm	\$ 9.03
TA35024	2.4 mm	11 mm X 19 mm	\$ 9.03
TA35025	2.5 mm	12 mm X 19 mm	\$ 9.03
TA35028	2.8 mm	13 mm X 19 mm	\$ 9.03
TA35030	3.0 mm	14 mm X 19 mm	\$ 9.03
TA35032	3.2 mm	15 mm X 19 mm	\$ 9.03
TA35035	3.5 mm	16 mm X 19 mm	\$ 9.03
TA35040	4.0 mm	17 mm X 19 mm	\$ 9.03
TA35050	5.0 mm	18 mm X 19 mm	\$ 9.03
TA35060	6.0 mm	19 mm X 19 mm	\$ 10.43



CARBIDE TIPPED COUNTERSINK

Mount on Spiral

ITEM NO. Right Hand	ITEM NO. Left Hand	SMALL Inside Diameter	LARGE Inside Diameter	PRICE
CS04016R	CS04016L	4 mm	16 mm	\$13.30
CS05016R	CS05016L	5 mm	16 mm	\$13.30
CS06016R	CS06016L	6 mm	16 mm	\$13.30
CS63516R	CS63516L	6.35 mm	16 mm	\$13.30
CS07016R	CS07016L	7 mm	16 mm	\$13.30
CS08018R	CS08018L	8 mm	18 mm	\$13.93
CS09018R	CS09018L	9 mm	18 mm	\$13.93
CS10020R	CS10020L	10 mm	20 mm	\$15.05
CS12020R	CS12020L	12 mm	20 mm	\$15.05



Mount on spiral

Hinge Boring Bit Extension Adapter

ITEM NO.	Inside Diameter	SHANK	OVERALL LENGTH	PRICE
HB-EXT-6	10 mm	10mm	6-1/2"	\$19.25
HB-EXT-8	10 mm	10mm	8-1/2"	\$23.45





ComSurge Tooling, Inc.

M2 High Speed Steel 7/16-14" Steel Screw Shank Dowel Drills (No. 203)

ITEM NO.	DIAMETER INCHES	TWIST LENGTH	OVERALL LENGTH	ROTATION DIRECTION	PRICE
HS203-62031	1/4	2	3-1/2	Right	\$ 23.03
HS203-62032	5/16	2	3-1/2	Right	\$ 23.03
HS203-62033	3/8	2	3-1/2	Right	\$ 23.10
HS203-62034	7/16	2	3-1/2	Right	\$ 25.13
HS203-62035	1/2	2	3-1/2	Right	\$ 25.90
HS203-62004	1/8	3	4-1/2	Right	\$ 22.75
HS203-62041	3/16	3	4-1/2	Right	\$ 22.75
HS203-62006	7/32	3	4-1/2	Right	\$ 22.89
HS203-62042	1/4	3	4-1/2	Right	\$ 23.03
HS203-62043	9/32	3	4-1/2	Right	\$ 23.03
HS203-62044	5/16	3	4-1/2	Right	\$ 23.03
HS203-62045	11/32	3	4-1/2	Right	\$ 23.73
HS203-62046	3/8	3	4-1/2	Right	\$ 23.10
HS203-62046-6	3/8	4-1/4	6	Right	\$ 35.91
HS203-62047	25/64	3	4-1/2	Right	\$ 25.13
HS203-62048-1	13/32	3	4-1/2	Right	\$ 25.13
HS203-62048	7/16	3	4-1/2	Right	\$ 25.13
HS203-62049	29/64	3	4-1/2	Right	\$ 25.90
HS203-62050-6	31/64	3	5	Right	\$ 35.70
HS203-62050	1/2	3	4-1/2	Right	\$ 25.90
HS203-3364	33/64	3	4-1/2	Right	\$ 31.50
HS203-62013	17/32	3	4-1/2	Right	\$ 31.50
HS203-62051	9/16	3	4-1/2	Right	\$ 31.50
HS203-62052	5/8	3	4-1/2	Right	\$ 34.30
HS203-62053	3/4	3	4-1/2	Right	\$ 50.40
HS203-62054	7/8	3	4-1/2	Right	\$ 65.80
HS203-62055	1"	3	4-1/2	Right	\$ 68.60
HS203-62036	1/4	2	3-1/2	Left	\$ 24.15
HS203-62037	5/16	2	3-1/2	Left	\$ 24.15
HS203-62038	3/8	2	3-1/2	Left	\$ 24.50
HS203-62039	7/16	2	3-1/2	Left	\$ 26.53
HS203-62040	1/2	2	3-1/2	Left	\$ 27.30
HS203-62056	3/16	3	4-1/2	Left	\$ 23.80
HS203-62057	1/4	3	4-1/2	Left	\$ 23.80
HS203-62058	9/32	3	4-1/2	Left	\$ 24.15
HS203-62059	5/16	3	4-1/2	Left	\$ 24.15
HS203-62060	11/32	3	4-1/2	Left	\$ 25.20
HS203-62061	3/8	3	4-1/2	Left	\$ 25.20
HS203-62062	25/64	3	4-1/2	Left	\$ 25.83
HS203-62062-1	13/32	3	4-1/2	Left	\$ 25.83
HS203-62063	7/16	3	4-1/2	Left	\$ 27.23
HS203-62064	29/64	3	4-1/2	Left	\$ 28.00
HS203-62065	1/2	3	4-1/2	Left	\$ 28.00
HS203-62066	9/16	3	4-1/2	Left	\$ 32.20
HS203-62067	5/8	3	4-1/2	Left	\$ 36.40
HS203-62068	3/4	3	4-1/2	Left	\$ 51.10
HS203-62069	1	3	4-1/2	Left	\$ 69.93





ComSurge Tooling, Inc.

Carbide Tipped 7/16-14" Steel Screw Shank Dowel Drills (No. 203CT)

ITEM NO.	DIAMETER INCHES	TWIST LENGTH	OVERALL LENGTH	ROTATION DIRECTION	PRICE
HS203CT-62099	1/4	2	3-1/2	Right	\$ 51.80
HS203CT-62100	5/16	2	3-1/2	Right	\$ 57.40
HS203CT-62101	3/8	2	3-1/2	Right	\$ 61.60
HS203CT-62102	7/16	2	3-1/2	Right	\$ 65.80
HS203CT-62103	1/4	3	4-1/2	Right	\$ 63.00
HS203CT-1764	17/64	3	4-1/2	Right	\$ 77.00
HS203CT-62104	5/16	3	4-1/2	Right	\$ 63.00
HS203CT-62105	3/8	3	4-1/2	Right	\$ 65.80
HS203CT-62106	25/64	3	4-1/2	Right	\$ 67.20
HS203CT-62107	7/16	3	4-1/2	Right	\$ 68.60
HS203CT-62108	1/2	3	4-1/2	Right	\$ 68.60
HS203CT-58RH	5/8	3	4-1/2	Right	\$ 92.40
HS203CT-875	7/8	3	4-1/2	Right	\$ 96.60
HS203CT-1516	15/16	3	4-1/2	Right	\$ 96.60
HS203CT-1516E	15/16	3	6	Right	\$ 99.40
HS203CT-62119ES	1	4-1/2	5-15/16	Right	\$ 100.80
HS203CT-62119E	1	4-1/2	6	Right	\$ 100.80
HS203CT-62120	1	4-1/5	5-3/4	Right	\$ 100.80
HS203CT-62121	1	4	5-1/2	Right	\$ 100.80
HS203CT-62109	1/4	3	4-1/2	Left	\$ 65.80
HS203CT-62110	5/16	3	4-1/2	Left	\$ 67.20
HS203CT-62111	3/8	3	4-1/2	Left	\$ 71.40
HS203CT-62112	25/64	3	4-1/2	Left	\$ 74.20
HS203CT-62113	7/16	3	4-1/2	Left	\$ 75.60
HS203CT-62114	1/2	3	4-1/2	Left	\$ 75.60
HS203CT-58LH	5/8	3	4-1/2	Left	\$ 95.20
HS203CT-875	7/8	3	4-1/2	Left	\$ 96.60



7/16-14" M2 Steel Screw Shank Dowel Drills (No.203B)

ITEM NO.	DIAMETER INCHES	TWIST LENGTH	OVERALL LENGTH	ROTATION DIRECTION	PRICE
HS203B-62070	3/16	1-3/4	4-1/2	Right	\$ 24.50
HS203B-62071	1/4	1-3/4	4-1/2	Right	\$ 25.69
HS203B-62073	3/8	1-3/4	4-1/2	Right	\$ 24.50
HS203B-62075	7/16	1-3/4	4-1/2	Right	\$ 26.53
HS203B-62080	3/8	1-3/4	4-1/2	Left	\$ 25.90





ComSurge Tooling, Inc.

M2 High Speed Steel 7/16-14" Steel Screw Shank Dowel Drills (No.204)-VP

ITEM NO.	DIAMETER INCHES	TWIST LENGTH	OVERALL LENGTH	ROTATION DIRECTION	PRICE
HS204-316	3/16	3	4-1/2	Right	\$ 27.93
HS204-62095	3/8	3	4-1/2	Right	\$ 27.30
HS204-62096	7/16	3	4-1/2	Right	\$ 27.93
HS204-1732	17/32	3	4-1/2	Right	\$ 30.10
HS204-2132	21/32	3	4-1/2	Right	\$ 37.73
HS316LH	3/16	3	4-1/2	Left	\$ 27.93
HS204-62097	3/8	3	4-1/2	Left	\$ 27.30



M2 High Speed Steel 7/16-14" Steel Screw Shank Dowel Drills (No.203J)-VP

ITEM NO.	DIAMETER INCHES	TWIST LENGTH	OVERALL LENGTH	ROTATION DIRECTION	PRICE
HS203J-62092	1/4	1-1/2	2-3/4	Right	\$ 27.93
HS203J-62089	3/8	1-1/2	2-3/4	Right	\$ 27.30
HS203J-62090	7/16	1-1/2	2-3/4	Right	\$ 27.93



Carbide Tipped 1/2"x 2" Shank Brad Point Spur Machine Drills (No. 200CT)

ITEM NO.	DIAMETER INCHES	TWIST LENGTH	OVERALL LENGTH	ROTATION DIRECTION	PRICE
HS200CT-62189	1/4	3	5	Right	\$ 63.00
HS200CT-62190	5/16	3	5	Right	\$ 63.00
HS200CT-62191	3/8	3	5	Right	\$ 65.80
HS200CT-62192	7/16	3	5	Right	\$ 67.20
HS200CT-62193	1/2	3	5	Right	\$ 68.60
HS200CT-62194	5/8	3	5	Right	\$ 82.60
HS200CT-62195	3/4	3	5	Right	\$ 96.60
HS200CT-62196	1/4	4	6	Right	\$ 63.00
HS200CT-62197	5/16	4	6	Right	\$ 63.00
HS200CT-62198	3/8	4	6	Right	\$ 65.80
HS200CT-62199	7/16	4	6	Right	\$ 67.20
HS200CT-62146	29/64	4	6	Right	\$ 68.60
HS200CT-62200	1/2	4	6	Right	\$ 68.60
HS200CT-62201	5/8	4	6	Right	\$ 82.60
HS200CT-62202	3/4	4	6	Right	\$ 96.60
HS200CT-875	7/8	4	6	Right	\$ 96.60
HS200CT-1516	15/16	4	6	Right	\$ 96.60
HS200CT-62188	1	4	6	Right	\$ 100.80
HS200CT-62188-L	1	4	8-1/4	Right	\$ 105.00
HS200CT-62188WF	1	4	6	Right	\$ 100.80





ComSurge Tooling, Inc.



M2 HSS Adjustable Counter Bores with 7/16-14" Thread Shanks (No. 121)

ITEM NO.	OUTSIDE DIAMETER	INSIDE DIAMETER	TWIST LENGTH	OVERALL LENGTH	ROTATION DIRECTION	PRICE
HS121-62249	3/8	3/16	2-1/2	4-1/2	Right	\$ 35.91
HS121-716	7/16	3/16	2-1/2	4-1/2	Right	\$ 35.91
HS121-62250	1/2	3/16	2-1/2	4-1/2	Right	\$ 35.91
HS121-62251	1/2	7/32	2-1/2	4-1/2	Right	\$ 35.91
HS121-62252	1/2	1/4	2-1/2	4-1/2	Right	\$ 35.91
HS121-62253	3/8	3/16	2-1/2	4-1/2	Left	\$ 35.91
HS121-62254	1/2	3/16	2-1/2	4-1/2	Left	\$ 35.91
HS121-62255	1/2	7/32	2-1/2	4-1/2	Left	\$ 35.91
HS121-62256	1/2	1/4	2-1/2	4-1/2	Left	\$ 35.91



M2 HSS V-Point Adjustable Countersinks with 7/16-14" Thread Shanks (No. 121V)

ITEM NO.	OUTSIDE DIAMETER	INSIDE DIAMETER	TWIST LENGTH	OVERALL LENGTH	ROTATION DIRECTION	PRICE
HS121V-62257	3/8	3/16	2-1/2	4-1/2	Right	\$ 38.50
HS121V-62258	1/2	3/16	2-1/2	4-1/2	Right	\$ 38.50

M2 High Speed Steel 1/2" x 2" Adjustable Counterbores (No.122)



ITEM NO.	OUTSIDE DIAMETER	INSIDE DIAMETER	TWIST LENGTH	OVERALL LENGTH	ROTATION DIRECTION	PRICE
HS122-62261	3/8	1/8	2-1/2	4-1/2	Right	\$ 30.73
HS122-62262	3/8	5/32	2-1/2	4-1/2	Right	\$ 30.73
HS122-62263	3/8	3/16	2-1/2	4-1/2	Right	\$ 30.73
HS122-62263LH	3/8	3/16	2-1/2	4-1/2	Left	\$ 32.13
HS122-62264	7/16	3/16	2-1/2	4-1/2	Right	\$ 30.73
HS122-62265	7/16	7/32	2-1/2	4-1/2	Right	\$ 30.73
HS122-62268	1/2	3/16	2-1/2	4-1/2	Right	\$ 30.73
HS122-62269	1/2	7/32	2-1/2	4-1/2	Right	\$ 30.73
HS122-62270	1/2	1/4	2-1/2	4-1/2	Right	\$ 30.73
HS122-62273	5/8	3/16	2-1/2	4-1/2	Right	\$ 46.13
HS122-62274	5/8	1/4	2-1/2	4-1/2	Right	\$ 46.13
HS122-62276	5/8	5/16	2-1/2	4-1/2	Right	\$ 47.53
HS122-62277	3/4	3/16	2-1/2	4-1/2	Right	\$ 50.33
HS122-62280	3/4	5/16	2-1/2	4-1/2	Right	\$ 50.33
HS122-62281	3/4	3/8	2-1/2	4-1/2	Right	\$ 50.33



ComSurge Tooling, Inc.



1/2" x 2" Carbide-Tipped Adjustable Counterbores (No.122CT)

ITEM NO.	OUTSIDE DIAMETER	INSIDE DIAMETER	TWIST LENGTH	OVERALL LENGTH	ROTATION DIRECTION	PRICE
HS122CT-62292	3/8	3/16	2-1/2	4-1/2	Right	\$ 46.13
HS122CT-62293	1/2	3/16	2-1/2	4-1/2	Right	\$ 46.13



1/2" x 2" Carbide-Tipped Adjustable Countersinks (No.122VCT)

ITEM NO.	OUTSIDE DIAMETER	INSIDE DIAMETER	TWIST LENGTH	OVERALL LENGTH	ROTATION DIRECTION	PRICE
HS122VCT-62297	1/2	3/16	2-1/2	4-1/2	Right	\$ 46.13



1/2" x 2" M2 High Speed Steel Adjustable Countersinks (No.122V)

ITEM NO.	OUTSIDE DIAMETER	INSIDE DIAMETER	TWIST LENGTH	OVERALL LENGTH	ROTATION DIRECTION	PRICE
HS122V-62282	3/8	1/8	2-1/2	4-1/2	Right	\$ 30.73
HS122V-62283	3/8	5/32	2-1/2	4-1/2	Right	\$ 30.73
HS122V-62284	3/8	3/16	2-1/2	4-1/2	Right	\$ 30.73
HS122V-62286	7/16	7/32	2-1/2	4-1/2	Right	\$ 30.73
HS122V-62289	1/2	3/16	2-1/2	4-1/2	Right	\$ 30.73
HS122V-62290	1/2	7/32	2-1/2	4-1/2	Right	\$ 30.73
HS122V-62290	1/2	7/32	2-1/2	4-1/2	Right	\$ 30.73
HS122V-62291	1/2	1/4	2-1/2	4-1/2	Right	\$ 30.73



1/4 X4-1/2 M2 High Speed Steel Brad Point Center Drills (No. 122C)

ITEM NO.	DIAMETER INCHES	CUTTING LENGTH	OVERALL LENGTH	SHANK	PRICE
HS122C-62469	5/16	1-1/2	6	1/4	\$ 23.73
HS122C-62470	3/8	1-1/2	6	1/4	\$ 27.93
HS122C-62471	7/16	1-1/2	6	1/4	\$ 30.73
HS122C-62472	1/2	1-1/2	6	1/4	\$ 31.50



ComSurge Tooling, Inc.



M2 HSS Straight Shank Brad Point Center Drills (No.122B)

ITEM NO.	DIAMETER INCHES	TWIST LENGTH	OVERALL LENGTH	ROTATION DIRECTION	PRICE
HS122B8-62382	3/16	3-1/2	8	Right	\$ 11.13
HS122B8-62383	3/16	3-1/2	8	Right	\$ 13.30
HS122B8-62384	3/16	3-1/2	8	Right	\$ 12.53
HS122B-62385	1/8	2-1/4	6	Right	\$ 6.93
HS122B-62386	5/32	2-1/4	6	Right	\$ 7.35
HS122B-62387	3/16	2-1/4	6	Right	\$ 6.93
HS122B-62388	7/32	2-1/4	6	Right	\$ 8.33
HS122B-62389	1/4	2-1/4	6	Right	\$ 8.33
HS122B-62392	5/16	2-1/4	6	Right	\$ 8.75
HS122B-62393	3/8	2-1/4	6	Right	\$ 9.73
HS122B-62393LH	3/8	2-1/4	6	Left	\$ 33.53
HS122B-62394	3/16	2-1/4	6	Left	\$ 24.50
HS122B-62395	7/32	2-1/4	6	Left	\$ 25.90
HS122B-62396	1/4	2-1/4	6	Left	\$ 27.30

M2 HSS Adjustable Counterbores (No.123)



ITEM NO.	OUTSIDE DIAMETER	INSIDE DIAMETER	OVERALL LENGTH	PRICE
HS123-62301	3/8	3/16	1-1/2	\$ 25.13
HS123-62304	1/2	1/4	1-1/2	\$ 27.93
HS123-62307	3/4	1/4	2	\$ 36.75
HS123-62308	3/4	5/16	2	\$ 36.75
HS123-62309	7/8	5/16	2	\$ 38.85
HS123-62310	7/8	3/8	2	\$ 39.20
HS123-62311	7/8	7/16	2	\$ 39.20
HS123-62312	1	5/16	2	\$ 44.10
HS123-62313	1	3/8	2	\$ 44.10
HS123-62313-716	1	7/16	2	\$ 44.10
HS123-62314	1	1/2	2	\$ 44.10
HS123-62316	1-1/4	1/2	2	\$ 65.10
HS123-62318	1-1/2	1/2	2	\$ 69.93



ComSurge Tooling, Inc.



M2 HSS Straight Shank V Point Drills (No. 122D)

ITEM NO.	DIAMETER INCHES	TWIST LENGTH	OVERALL LENGTH	ROTATION DIRECTION	PRICE
HS122D-62426	3/32	2-1/4	6	Right	\$ 13.93
HS122D-62427	1/8	2-1/4	6	Right	\$ 9.73
HS122D-62428	5/32	2-1/4	6	Right	\$ 15.33
HS122D-62430	3/16	2-1/4	6	Right	\$ 9.73
HS122D-62431	7/32	2-1/4	6	Right	\$ 11.13
HS122D-62432	1/4	2-1/4	6	Right	\$ 11.13
HS122D-62433	9/32	2-1/4	6	Right	\$ 20.30
HS122D-62434	5/16	2-1/4	6	Right	\$ 23.31
HS122D-62416	11/32	2-1/4	6	Right	\$ 24.15
HS122D-62435	3/8	2-1/4	6	Right	\$ 27.65
HS122D8-62425	1/4	3-1/2	8	Right	\$ 27.09

Carbide Tipped Adjustable Counter Bores (No. 123CT)

ITEM NO.	OUTSIDE DIAMETER	INSIDE DIAMETER	OVERALL LENGTH	PRICE
HS123CT-62312	1	5/16	2	\$ 51.80
HS123CT-62312-1	1	3/16	2	\$ 49.00
HS123CT-62313	1	3/8	2	\$ 54.60
HS123CT-62312-2	1	7/16	2	\$ 54.60



M2 HSS Straight Shank Brad Point Center Drills (No. 124B)

ITEM NO.	DIAMETER INCHES	TWIST LENGTH	OVERALL LENGTH	ROTATION DIRECTION	PRICE
HS124B-62402	1/8	2-1/4	4-1/2	Right	\$ 9.73
HS124B-62403	5/32	2-1/4	4-1/2	Right	\$ 10.15
HS124B-62404	3/16	2-1/4	4-1/2	Right	\$ 9.73
HS124B-62405	7/32	2-1/4	4-1/2	Right	\$ 11.13
HS124B-62406	1/4	2-1/4	4-1/2	Right	\$ 11.13
HS124B-38R	3/8	2-1/4	4-1/2	Right	\$ 21.70
HS124B-62452-1	9/64	1	2-3/4	Right	\$ 10.50



ComSurge Tooling, Inc.

M2 HSS Adjustable Countersinks (No.125)



ITEM NO.	Countersink Size	Drill Size	OVERALL LENGTH	ROTATION DIRECTION	PRICE
HS125-62326	3/8	3/16	1-1/2	Right	\$ 24.50
HS125-62331	1/2	3/16	1-1/2	Right	\$ 24.50
HS125-62332	1/2	7/32	1-1/2	Right	\$ 24.50
HS125-62333	1/2	1/4	1-1/2	Right	\$ 24.50

M2 Carbide Tipped Adjustable Countersinks (No.125CT)



ITEM NO.	Countersink Size	Drill Size	OVERALL LENGTH	ROTATION DIRECTION	PRICE
HS125CT-62341	1/2	1/8	1-3/8	Right	\$ 41.93
HS125CT-62338	1/2	3/16	1-3/8	Right	\$ 41.93
HS125CT-62339	1/2	7/32	1-1/2	Right	\$ 41.93
HS125CT-62340	1/2	1/4	2	Right	\$ 41.93

Carbide Tipped Countersinks for Wood Screws/2-Wings



ITEM NO.	OUTSIDE DIAMETER	INSIDE DIAMETER	Shank	OVERALL LENGTH	PRICE
CS-55200	11/32	3/32	5/16	2-1/4	\$ 9.73
CS-55202	3/8	1/8	5/16	2-9/16	\$ 10.50
CS-55205	1/2	1/8	5/16	2-9/16	\$ 27.30
CS-55211	1/2	3/16	3/8	3	\$ 27.30
CS-55215	1/2	1/4	3/8	3	\$ 27.30

Carbide Tipped Multi-Spur Machine Bits (No.149CT)



ITEM	DIAMETER	SHANK	OAL	PRICE
HS149CT-62779	3/4	1/2	6	\$ 96.60
HS149CT-62782	1	1/2	6	\$ 110.60
HS149CT-62790	1-1/2	1/2	6	\$ 119.00
HS149CT-62796	2-1/8	1/2	6	\$ 133.00



ComSurge Tooling, Inc.

M2 HSS Multi-Spur Counterbores* (No. 120)

ITEM NO.	OUTSIDE DIAMETER	Bore Sizes	PRICE
HS120-62344	1	1/2	\$ 77.00
HS120-62345	1-1/8	1/2	\$ 77.00
HS120-62346	1-1/4	1/2	\$ 77.00
HS120-62347	1-3/8	1/2	\$ 77.00
HS120-62348	1-1/2	1/2	\$ 81.20
HS120-62349	1-5/8	1/2	\$ 81.20
HS120-62350	1-3/4	1/2	\$ 81.20
HS120-62351	1-7/8	1/2	\$ 81.20
HS120-62352	2	1/2	\$ 81.20
HS120-62353	2-1/8	1/2	\$ 86.80
HS120-62354	2-1/4	1/2	\$ 91.00
HS120-62355	2-1/2	1/2	\$ 96.60

High Speed Steel Multi-Spur Machine Bits (No.149)

ITEM	DIAMETER	SHANK	OAL	PRICE
HS149-62738	5/8	1/2	6	\$ 39.20
HS149-62744	1	1/2	6	\$ 54.60
HS149-62746	1-1/8	1/2	6	\$ 58.80
HS149-62752	1-1/2	1/2	6	\$ 61.60
HS149-62760	2	1/2	6	\$ 67.20
HS149-62761	2-1/8	1/2	6	\$ 72.80
HS149-62762	2-1/4	1/2	6	\$ 74.20
HS149-62763	2-3/8	1/2	6	\$ 79.80
HS149-62764	2-1/2	1/2	6	\$ 82.60
HS149-62765	2-5/8	1/2	6	\$ 86.80
HS149-62766	2-3/4	1/2	6	\$ 95.20
HS149-62767	2-7/8	1/2	6	\$ 100.80
HS149-62768	3	1/2	6	\$ 102.20
HS149-62774	3-1/8	1/2	6	\$ 119.00
HS149-62775	3-1/4	1/2	6	\$ 124.60
HS149-62776	3-1/2	1/2	6	\$ 138.60
HS149-62777	3-3/4	1/2	6	\$ 152.60
HS149-62778	4	1/2	6	\$ 194.60
HS149-62797	4-1/2	1/2	6	\$ 208.60





ComSurge Tooling, Inc.



High Speed Steel Multi-Spur Machine Bits with 3/8" Hex End

ITEM	DIAMETER	SHANK	OAL	PRICE
HS738-058	5/8	1/2	7	\$ 39.20
HS738-078	7/8	1/2	7	\$ 44.80
HS738-100S*	1	1/2	7	\$ 54.60
HS738-112	1-1/2	1/2	7	\$ 61.60
HS738-112S*	1-1/2	1/2	7	\$ 61.60
HS738-218	2-1/8	1/2	7	\$ 72.80
HS738-218S*	2-1/8	1/2	7	\$ 72.80
HS7538-218S*	2-1/8	1/2	7-1/2	\$ 72.80
HS838-100	1	1/2	8	\$ 54.60



Carbide Tipped Multi-Spur Machine Bits with 3/8" Hex End (No.738CT)

ITEM	DIAMETER	SHANK	OAL	PRICE
HS738CT-078	7/8	1/2	7	\$ 81.20
HS738CT-100	1	1/2	7	\$ 95.20
HS738CT-100S*	1	1/2	7	\$ 95.20
HS738CT-112	1-1/2	1/2	7	\$ 95.20
HS738CT-112S*	1-1/2	1/2	7	\$ 103.60
HS738CT-134	1-3/4	1/2	7	\$ 103.60
HS738CT-15/16	15/16	1/2	7	\$ 109.20
HS738CT-218	2-1/8	1/2	7	\$ 117.60
HS738CT-218S*	2-1/8	1/2	7	\$ 117.60
HS838CT-100	1	1/2	8	\$ 106.40

* 1 Raker or 2 Raker Available



ComSurge Tooling, Inc.

Carbide Tipped 2-Wing Drills (No. 811CT)



ITEM	DIAMETER	Shank	OAL	TAPER	PRICE
HS811CT-875	7/8	1/2	6		\$ 106.40
HS811CT-100-8	1	1/2	8		\$ 110.60
HS811CT-100EH*	1	1/2	8		\$ 82.60
HS811CT-112	1-1/2	1/2	6		\$ 119.00
HS811CT-218T30	2-1/8	1/2	6	30°	\$ 124.60
HS811CT-238	2-3/8	1/2	6		\$ 138.60
HS811CT-62800	1-3/8	1/2	6		\$ 119.00
HS811CT-62811	1.28	1/2	6		\$ 119.00

*With 3/8 hex shank

Carbide Tipped 3-Wing 6" Boring Bits/ With 3 Spurs (No.812CT)



ITEM	DIAMETER	Shank	OAL	TAPER	PRICE
HS812CT-62827	5/8	1/2	6		\$ 105.00
HS812CT-62829	3/4	1/2	6		\$ 110.60
HS812CT-62831	7/8	1/2	6		\$ 119.00
HS812CT-62832	1	1/2	6		\$ 123.20
HS812CT-100R*	1	1/2	6		\$ 127.40
HS812CT-62833	1-1/8	1/2	6		\$ 131.60
HS812CT-62834	1-1/4	1/2	6		\$ 131.60
HS812CT-62835	1-3/8	1/2	6		\$ 131.60
HS812CT-62836	1-1/2	1/2	6		\$ 131.60
HS812CT-150R*	1-1/2	1/2	6		\$ 137.20
HS812CT-62837	1-5/8	1/2	6		\$ 147.00
HS812CT-62838	1-3/4	1/2	6		\$ 147.00
HS812CT-62839	1-7/8	1/2	6		\$ 147.00
HS812CT-62840	2	1/2	6		\$ 147.00
HS812CT-62841	2-1/8	1/2	6		\$ 138.60
HS812CT-62841WF	2-1/8	1/2	6		\$ 156.80
HS812CT-62843	2-1/2	1/2	6		\$ 152.60
HS812CT-218	2-1/8	1/2	6		\$ 138.60
HS812CT-218R*	2-1/8	1/2	6		\$ 138.60
HS812CT-218T30	2-1/8	1/2	6	30°	\$ 138.60
HS812CT-238	2-3/8	1/2	6		\$ 180.60
HS812CT-238D5	2-3/8	1/2	6	5°	\$ 180.60

* The Center drill is removable.

Delta

Self Adhesive Steel Tape Measure



Item Number	Length	Description	Prices
97-056	12'	Right-1/2-Inch Wide Metric/English	\$ 17.42
97-057	12'	Left-1/2-Inch Wide Metric/English	\$ 18.80
97-061	12'	Right-1/2-Inch Wide English	\$ 17.42
97-062	12'	Left-1/2-Inch Wide English	\$ 18.80
97-064	12'	Right-3/4-Inch Wide Metri/English	\$ 24.40
97-065	12'	Right-3/4-Inch Wide English	\$ 24.40
97-066	12'	Left-3/4-Inch Wide English	\$ 24.40
97-067	6'	Right 3/4-Inch Wide Metric/English	\$ 16.70
97-068	6'	Right 3/4-Inch Wide English	\$ 16.70
97-069	6'	Right-1/2-Inch Wide English	\$ 13.50
97-070	6'	Left-1/2-Inch Wide English	\$ 13.50

We Also Have.....



Band Saws Blade



Sanding Drum



Grinding Wheels



Clamping Tools



Scroll Saw Blades



Moulding Cutter Knives



Abrasive Discs



Abrasive Belts

Call Us Today!

THE DOOR STORE

Jigs for Cabinet Doors



Crown Panel Jig

18CPJ features a built-in automatic pinion gear centering device for cabinet doors. (18" opening for panels). **\$239.00**

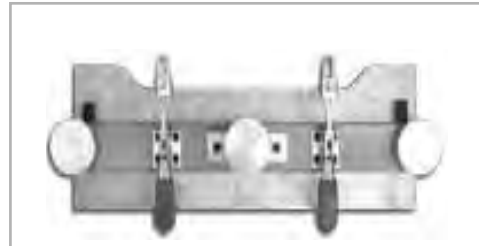

Crown Rail Jig

18CRJ features a built-in automatic pinion gear centering device for cabinet doors. (18" opening for rail). **\$239.00**

Crown Rail and Panel Patterns

PART	DESCRIPTION	PRICE
18CPP	10 Crown Panel Patterns	\$129.00
18CRP	10 Crown Top Rail Patterns	\$129.00

Arc Rail and Panel Patterns

PART	DESCRIPTION	PRICE
18RPP	12 Round Panel Patterns	\$129.00
18RRP	12 Round Top Rail Patterns	\$129.00

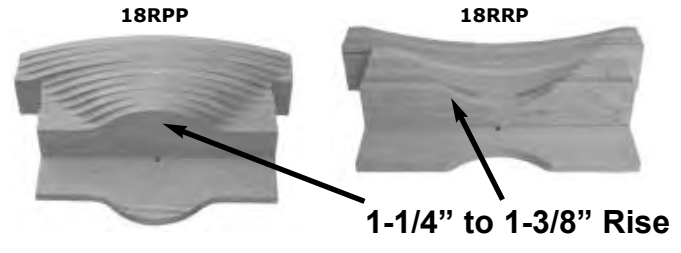
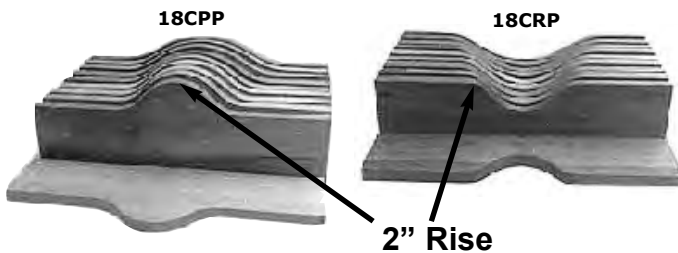

Patterns are made of hardwood and are interchangeable for making doors 9 -1/2" to 22", using 2" stiles. Patterns are 18" long.

Set 1

PART	PRICE
DOORSTORESET1	\$649.00

Includes: 18CRJ, 18CPJ, 18CRP and 18CPP



Set 2

PART	PRICE
DOORSTORESET2	\$649.00

Includes: 18CRJ, 18CPJ, 18RRP and 18RPP



Set 3

PART	PRICE
DOORSTORESET3	\$849.00

Includes: 18CRJ, 18CPJ, DS18CRP, 18CPP, 18RRP and 18RPP

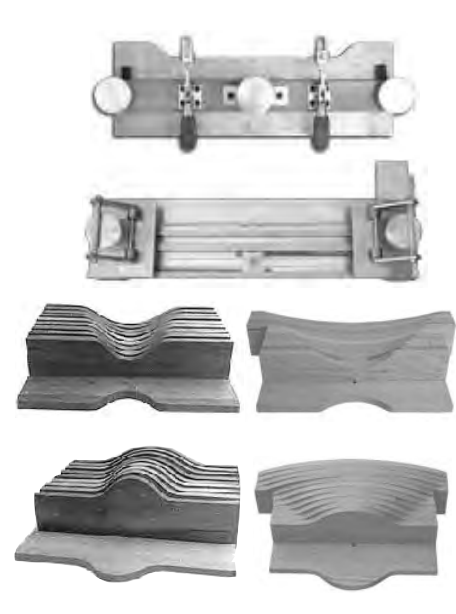

DYNABRADE Raised Panel Sander

3/16" ORBIT MODEL	PAD DIA.	PRICE
57906	4" x 3/4"	\$369.65



57956 - (4"x3/4") Replacement Pad for 57906.....	\$21.60
57957 - (4"x1-1/4") Replacement Pad for 57906.....	\$23.45

57906 Dynafine includes 57956 Raised Pane Pad (4" x 3/4" wide), with unique angled edges for sanding in tight corners and on raised panel edges. 57956 Raised Panel Pad is a premium urethane, medium density Hook-Face pad (1/2" thick), which accepts both coated abrasive and non-woven nylon sheets. Excellent for sanding raised panels and linear profiles. Also ideal for use on furniture, shutters, moldings and more.

DYNACUT Aluminum Oxide Raised Panel Strips

Dimensions (W X L)	Attachment Type	80 Grit	100 Grit	120 Grit	150 Grit	180 Grit	220 Grit	320 Grit	Package Quantity
7/8" X 4-1/2"	Hook	93363	93664	93670	93671	93672	93673	93677	10
1-3/8" X 4-1/2"	Hook	94001	94002	94003	94004	94005	94006	94007	10

DYNABRADE SANDING PADS

5" PSA AND HOOK & LOOP

Part Number	Description"	Price
PSA		
56102	Non-Vac, Soft, 3/8"	\$17.78
56106	Non-Vac, Medium, 3/8"	\$17.78
56175	Non-Vac, Medium, 5/8"	\$17.78
56176	Vac, Medium, 5/8"	\$17.78
56185	Non-Vac, Soft, 5/8"	\$17.78
56186	Vac, Soft, 5/8"	\$17.78
56104	Vac, 5 Hole	\$17.78
HOOK & LOOP		
56157	Non-Vac, Soft, 3/8"	\$21.83
54325	Non-Vac, Medium, 3/8"	\$19.26
56180	Non-Vac, Medium, 5/8"	\$19.13
56195	Non-Vac, Soft, 5/8"	\$19.13
54326	Vac, Medium, 3/8"	\$19.44
56196	Vac- Soft, 5/8"	\$19.13
57792	Radius-Edge, Non-Vac	\$28.26

6" PSA and HOOK & LOOP

Part Number	Description	Price
PSA		
56103	Non-Vac, Soft, 3/8"	\$19.94
56107	Non-Vac, Medium, 3/8"	\$19.94
56105	Vac, Medium, 3/8"	\$19.94
HOOK & LOOP		
54327	Non-Vac, Medium	\$20.52
56158	Non-Vac, Soft	\$23.45
56183	Vac, Medium	\$21.15

DYNABRADE ---- "Air" Sanders

Ballew Saw and Tool is a Full-Line Dynabrade dealer. Call us for the best deals on these products and many more!



DYNABRADE Spirit

Non-Vacuum - PSA No Hole

- Includes low profile, premium urethane weight-mated sanding pad
- Optional vacuum conversion kits available. to easily convert non-vacuum tool to self-generated or central vacuum tools.

3/16" ORBIT MODEL	3/32" ORBIT MODEL	PAD DIA.	PRICE
59020	59035	5 (127mm)	\$165.00
59025	--	6 (152 mm)	\$165.00

56106 - Replacement Pad for 59020 & 59035.....	\$17.78
56107 - Replacement Pad for 59025.....	\$19.94
Tune-Up Kit: No. 96510.....	\$91.50

Central Vacuum - PSA 5 Hole

- Includes low profile, premium urethane weight-mated sanding pad
- Has 1" outside diameter vacuum port, for easy connection to central vacuum system

3/16" ORBIT MODEL	PAD DIA.	PRICE
59024	5 (127mm)	\$175.00

56104 - Replacement Pad for 59024.....	\$17.78
Tune-Up Kit: No. 96510.....	\$91.50

Silver Supreme

Non-Vacuum - PSA No Hole

- Includes low profile, premium urethane weight-mated sanding pad
- Optional vacuum conversion kits available. to easily convert non-vacuum tool to self-generated or central vacuum tools.

3/16" ORBIT MODEL	3/32" ORBIT MODEL	PAD DIA.	PRICE
69020	69035	5 (127mm)	\$175.00
69025	69040	6 (152 mm)	\$175.00

56106 - Replacement Pad for 69020 & 69035.....	\$17.78
56107 - Replacement Pad for 69025.....	\$19.94
Tune-Up Kit: No. 96620.....	\$91.50

Central Vacuum - PSA 5 Hole

- Includes low profile, premium urethane weight-mated sanding pad
- Has 1" outside diameter vacuum port, for easy connection to central vacuum system

3/16" ORBIT MODEL	PAD DIA.	PRICE
69024	5 (127mm)	\$185.00

56104 - Replacement Pad for 69024.....	\$17.78
Tune-Up Kit: No. 96620.....	\$91.50

FEIN Blades

Item #	Description	Price
63502096050	2 - 1/2 inch circular saw blade, for cutting plastics, fiberglass, wood putty, non-ferrous metals and sheet metal up to 19 gauge. (5 pack of blades)	\$ 46.98
63502097050	3 -1/8 inch circular saw blade for cutting plastics, fiberglass, wood putty, non-ferrous metals and sheet metal up to 19 gauge. (5 pack of blades)	\$ 115.99
63502106080	3-1/8-Inch segmented saw blade for cutting plastics fiberglass, wood putty, non-ferrous metals and sheet metal up to 19 gauge, level with the surface. (5 pack of blades)	\$ 46.98
63502118016	2-1/2-Inch Segmented Carbide Grout Removal Blade Size For cutting out damaged tile joints and for cutting grooves in plaster, porous concrete and similar construction materials.	\$ 25.17
63502126130	Universal mount precision e-cut saw blade narrow, 10 pack, 1-3/8 inch wide. Highest cutting speed and precision with double row Japanese toothing, for wood up to 2 inch, drywall and soft plastics.	\$ 104.33
63502126290	1-3/8" Wide double row of Japanese style teeth allow for fast cutting in wood for your oscillating tool. This tooth configuration allows for the highest cutting speed and precision with for wood up to 2 inch, drywall and soft plastics.	\$ 89.99
63502127130	This is a 2-1/2-inch aggressive plunge cutting saw blade for the Multimaster Japanese pull saw tooth pattern that allows for very aggressive cutting in wood and other materials	\$ 124.06
63502130011	Mini cut saw blade for non ferrous metals and plastics, plunge depth 1 inch. 3/8-Inch Mini E-Cut Wood Blade, 2 Pack	\$ 19.99
63502133290	Standard Oscillating Blade (10 Pack), 1-3/8 x 2"	\$ 80.17
63502132013	This is a smaller blade for more detailed cuts in wood and other soft materials. The more aggressive tooth pattern allows for a more aggressive and faster cut. This is a perfect blade for modeling and trim work.	\$ 14.60
63502133070	Most popular E-Cut blades 2 metal/wood blades 2 wood blades 1 ea 1-3/8 and 1-2-9/16	\$ 34.87



FEIN Blades

Item #	Description	Price
63502134030	Fine teeth for all wood, plasterboard, and plastics, flush cut. Saws wood up to 2", drywall and soft plastics. Permits simple plunge cuts into the material at any spot. 2 - 1/2" wide	\$ 99.99
63502151130	Universal oscillating saw blades are designed to cut everything from wood, plaster, synthetic materials and metal. 10-pack of 1-1/8-inch wide blades.	\$ 84.58
63502151290	1-1/8" Wide Universal Bimetal teeth saw blade ideal for wood, plastics and copper pipes just to name a few applications. 8 x 2-3/8" Size	\$ 80.82
63502152130	Universal oscillating saw blades are designed to cut everything from wood, plaster, synthetic materials and metal. 10-pack of 1-3/4-inch wide blades.	\$ 93.98
63502152290	1-3/4" Wide Universal Bimetal teeth saw blade ideal for wood, plastics and copper pipes just to name a few applications. 4 x 2-3/8" Size	\$ 79.99
63502154010	Fein High Speed Circular Saw blade for wood- this is similar to a mini circular saw and is ideal for long straight cuts and for cutting parquet, laminate and particle. Cutting Diameter 4 inches	\$ 72.99
63502160130	Universal oscillating saw blades are designed to cut everything from wood, plaster, synthetic materials and metal. 10-pack of 1-3/8-inch wide blades.	\$ 141.00
63502160140	Consisting of 6 different E-Cut saw blades at a special price. Contents: 1 of each E-Cut Universal saw blade, 1-1/8" and 1-3/4", 2 E-Cut Long-Life saw blades, 1-3/8", 2 E-Cut Long-Life saw blades, 2-9/16", in a practical plastic storage case. With the FEIN MultiMount. Fits all popular multifunction tools.	\$ 59.00
63502160290	1-3/8" x 2" Long-Life BiMetal Blade ideal for cutting nails embedded in wood during long hard renovation projects.	\$ 153.00
63502161130	Fein Universal mount Long Life E-cut blades (10 pack) with special bi-metal teeth with a width of 2-9/16 inch.	\$ 153.00
63502161290	2-9/16" Long-Life BiMetal Blade ideal for cutting nails embedded in wood during long hard renovation projects.	\$ 131.31
63502170020	Carbide metal Semi circle blade 90 mm	\$ 161.00
63502174050	For plastics, GFRP, wood, putty, brass, bronze and sheet metal up to approx. 19 gauge, flush to the surface. 3-9/16 Diameter, 5 packs	\$ 121.99



63502151130



63502151290



63502152130



63502152290



63502160290



63502154010



63502170020



63502160130



63502134030



63502161130



63502160140



63502161290



63502174050

FEIN Accessories

Item #	Description	Price
63806129026	Sanding Pad With Hook And Loop Fasteners, 2-Pack	\$ 15.99
63806136029	Velcro Dust Extraction Sanding Pad (2 Pack)	\$ 23.60
63806140027	Fein Multimaster Felt Polishing Pad Felt Polishing Pad For Triangle	\$ 41.70
63806183013	Profile Sanding Set Consisting of 1 holder and 6 different profile inserts: 1 V-shape for 90° angles 1 trapezium for tongue-and-groove connections, 1 for straight profiles, 1 for convex forms (large), 1 each for concave and convex forms (small), as well as 5 sanding sheets grit 80, 120, and 180.	\$ 59.50
63806195020	4-1/2-Inch Sanding Pad with Paper for FMM 250Q 6 sanding sheets (2 sheets of each grit 60 / 80 / 180)	\$ 12.58



Item #	Description	Price
63901025060	Mini Cut and File Set 2 MiniCut Saw Blades for wood and soft plastics 2 HSS MiniCut Saw Blades for hard plastics, fiberglass and sheet metal 1 diamond file 1 carbide file With the new carbide file insert groove	\$ 34.99
63903128012	Mushroom Shaped Putty and Caulk Cutter Blade, 5 Pack, for the Fein caulking cutter designed to remove sealant from bath tiles or marble as well as putty from windows.	\$ 18.60
63903165013	Flexible Scraper Blade, 2 Pack For removing paint, carpet adhesive, flexible caulking and label adhesive. This scraper blade is ideal anywhere a putty knife might be used.	\$ 25.99
63903178017	Rigid Scraper Blade For removal of stubborn paint, adhesive residue, carpet, tile adhesive and undercoatings	\$ 8.39



Item #	Description	Price
92602083010	Table and Drill Stand Support The Fein Multimaster can be clamped to a table or 1-3/4-Inch workbench. It can also be clamped to commercially available drill stands with a 43-mm collar Diameter. Only suitable for the Fein Multimaster FMM 250/250Q	\$ 64.30



FEIN Accessories

Item #	Description	Price
63706012024	Fein Diamond Blade Includes MultiMaster 3/4 in. Normal Diamond File Insert Mini e-cut accessory, For sharpening, Normal grit	\$ 18.10
63706013028	Fein Diamond Blade Includes MultiMaster 3/4 in. Fine Diamond File Insert	\$ 16.10
63717086010	36 grit Fein hook and loop sanding for the Fein Multimaster. For universal applications on practically all surfaces. 50-pack quantity	\$ 27.80
63717109013	60 Grit Velcro Dustless Sandpaper, 50-Pack	\$ 26.80
63717111014	100 Grit Velcro Dustless Sandpaper, 50-Pack	\$ 26.80
63717112017	120 Grit Velcro Dustless Sandpaper, 50-Pack	\$ 26.80
63717114019	180 Grit Velcro Dustless Sandpaper, 50-Pack	\$ 26.80
63717115013	220 Grit Velcro Dustless Sandpaper, 50-Pack	\$ 26.80
63717127019	260 Grit Sandpaper Hook and Loop	\$ 26.80
63717179016	500-Grit Super Soft Sanding Sheets, 50-Pack	\$ 26.80
63717218014	120-Grit Profile Sanding Sheets, 25-Pack	\$ 13.60
63717236010	Zirconium Sanding Sheets Grit:40 35 pc(s)	\$ 26.00
63717238010	Zirconium Sanding Sheets Grit:80 35 pc(s)	\$ 26.00
63731001014	Triangular Carbide Rasp	\$ 20.98
63731002017	MultiMaster Finger Shaped Carbide Rasp	\$ 23.48



63706012024



63717086010



63717109013



63717127019



63717218014



63731001014



63731002017

Item #	Description	Price
30711129009	Replacement Carbon Brush-2pk	\$ 7.60
30762412990	Speed Control-120V-Fmm	\$ 61.10
32607065020	SAW BLADE HSS 4" W/STOP Fein High SpeedSet includes the Fein depth stop. Perfect for hardwood installers tillers and weekend warrior.	\$ 83.80



30762412990



30711129009



32607065020

FEIN



Ballew Saw Tool is a Full Line FEIN Dealer Complete Accessory Offering Available Drop Ship Available



Prices So Low, Fein Won't Let Us Print Them!

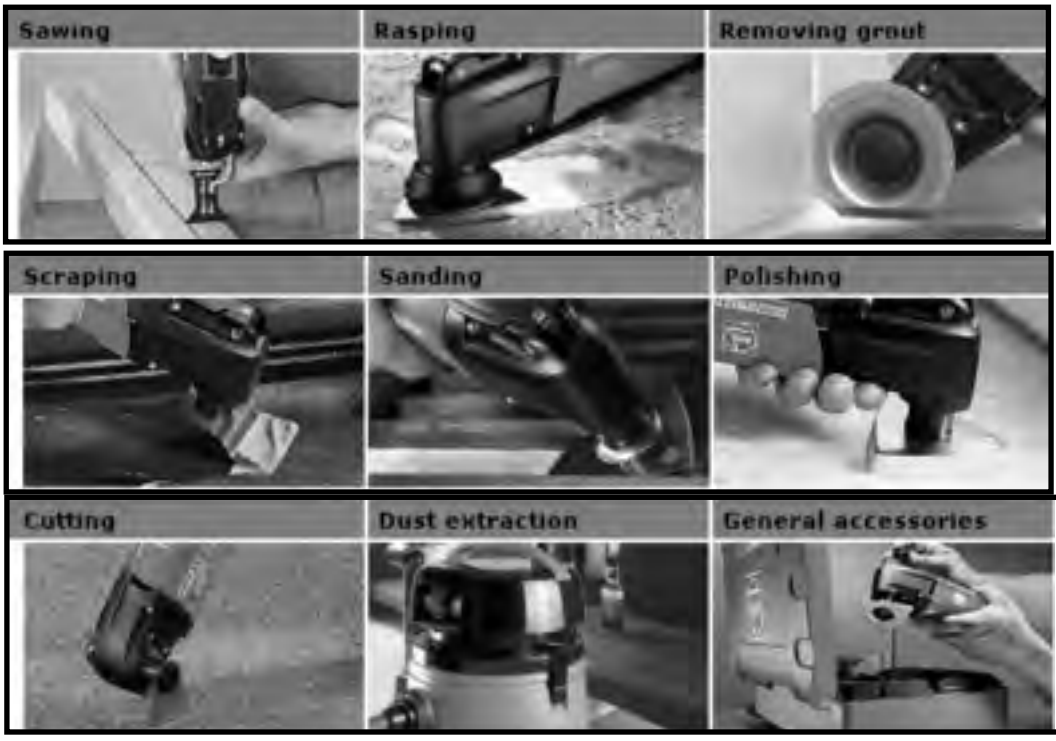

FESTOOL

Faster. Easier. Smarter.

Call us for model numbers, prices, and shipping details

As a distributor for **FESTOOL**, we also carry a large selection of accessories that accommodate the tools on this page. Currently our largest stocked and most frequently requested item is sandpaper. If you need to inquire about other items such as jigsaw blades, router bits, saw blades or any other Festool accessory, call **Ballew Saw and Tool, Inc.** at **1-800-288-7483**.



FESTOOL

Faster. Easier. Smarter.

Festool Saw Blades

Item #	Description	Price
486297	190mm x 2.8mm x 30mm 48-Tooth Fine Saw Blade, ATB (AT 65)	\$105.00
486299	190mm x 2.8mm x 30mm 68T Aluminum and Plastic Saw Blade, TC (AT 65)	\$139.00
489458	190mm x 2.6mm x 30mm 54-Tooth Laminate Saw Blade, TC (AT 65)	\$128.00
495377	Fine tooth saw blade 160mm x 2.5mm x 20mm for clean cross cuts in all wood materials. 48 tooth; 2.2mm kerf; 20mm arbor; 5 deg hook angle; ATB	\$78.00
495386	Carbide-tipped, TC saw blade for Kapex KS 120 sliding compound miter saw. Specially designed for cutting laminate. Length 260mm, Kerf 2.5mm, Bore 30mm, TC Tooth Shape and 64 Teeth	\$149.00
495387	Carbide-tipped, ATB saw blade for Kapex KS 120 sliding compound miter saw. For fine cuts, especially casing and molding. Use for wood and soft plastics. Length 260mm, Kerf 2.5mm, Bore 30mm, ATB Tooth Shape and 80 Teeth.	\$156.00
495388	Carbide-tipped, ATB saw blade for Kapex KS 120 sliding compound miter saw. For clean cuts in wood and soft plastics. Length 260mm, Kerf 2.5mm, Bore 30mm, ATB Tooth Shape and 60 Teeth.	\$144.00
496304	Universal 28-Tooth Saw Blade 25mm kerf; 20mm arbor; 15 deg hook angle; ATB	\$56.00
496305	Standard saw blade for all wood materials, building panels and soft plastics, coarse cuts. Use with Festool Plunge-Cut Saw Model TS 55 EQ. 12 tooth; 2.2mm kerf; 20mm arbor; 20 deg hook angle; ATB	\$50.00
496309	Solid Surface / Laminate 48-Tooth Saw Blade 48 tooth; 26mm kerf; 20mm arbor; 4 deg hook angle; TC	\$89.00



486297



495387

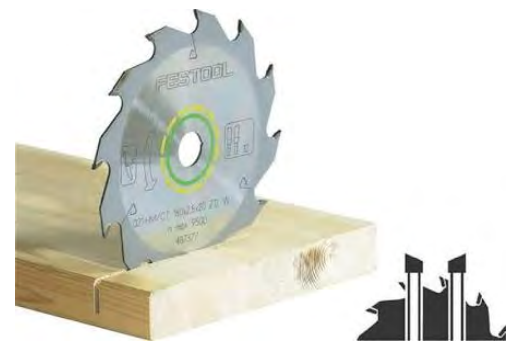

496305

FESTOOL

Faster. Easier. Smarter.

Festool Accessories

Item #	Description	Price
452898	Hose Sleeve, Antistatic Y-Adapter With Blanking Plug	\$39.00
487071	Replacement Antistatic Reducing Sleeve For D 27 Hose	\$23.00
488036	DX 93 StickFix Sanding Pad, Extended Length	\$21.00
488716	DX 93 StickFix Sanding Pad, Hard	\$23.00
488899	Base Plate And Sanding Pad Set for DX 93 Sander	\$31.00
489252	RTS 400 Replacement StickFix Pad, Soft, 80mm X 130mm (3 5/32 x 5 1/4 in)	\$29.00
489570	For securing guide rails. Pack of 2. Clamping thickness 4-11/16 inches (120 mm).	\$43.00
490161	Standard Flat Sanding Pad for use with LS 130 EQ Linear Sander.	\$33.00
491594	Quick Clamp For MFT And Guide Rail System, 6 5/8" (168mm)	\$39.00
492125	RO125 FEQ StickFix Sanding Pad, Soft, 125mm (5 in)	\$37.00
492126	RO125 FEQ StickFix Sanding Pad, Supersoft, 125mm (5 in)	\$37.00
492127	RO125 FEQ StickFix Sanding Pad, Hard, 125mm (5 in)	\$37.00
492280	Ets 125 Eq Jetstream Replacement Sanding Pad, Soft, 125mm (5 in)	\$39.00
492282	ETS 125 EQ Jetstream Sanding Pad, Supersoft, 125mm (5 in)	\$37.00
493723	DTS 400 StickFix Replacement Sanding Pad, Soft, 100 X 150mm (4 x 6 in)	\$29.00
496147	High-temp resistant for heavy-duty applications. 9 hole/soft	\$47.00
496149	High edge strength, for flat surfaces and narrow edges. 9 hole/hard	\$47.00
496802	Triangular pad for detail sanding, works with Festool 93mm sanding abrasives and compatible with Festool RO 90 DX sander	\$33.00
496804	High-temp resistant for heavy-duty applications and compatible with Festool RO 90 DX sander	\$33.00
497483	The extended flat delta-shaped sanding head for the RO 90 can be used for reaching under toe-kicks, deep into hard to reach corners, or for slats and louvers	\$21.00
498986	Fusion-Tec MultiJetstream Super-Soft Sanding Pad, 150mm Diameter	\$44.00
498987	Fusion-Tec MultiJetstream Soft Sanding Pad, 150mm Diameter	\$47.00
498988	Fusion-Tec MultiJetstream Hard Sanding Pad, 150mm Diameter	\$44.00



452898



488899



492282



496802

FOREST CITY



★★★Note: *Forest City* is out of business and we still have parts in stock. Meanwhile, we have integrated *ComSurge* for the future replacement for *Forest City*s parts listed below.★★★

**Steel Screw Shank Dowel Drills Super Wear™
No. X203**

PART	DIA.	TWIST LENGTH	OAL	ROTATION DIRECTION	PRICE
62032	5/16	2	3-1/2	Right	\$21.24
62034	7/16	2	3-1/2	Right	\$21.24
62036	1/4	2	3-1/2	Left	\$21.24
62037	5/16	2	3-1/2	Left	\$21.24
62038	3/8	2	3-1/2	Left	\$21.24
62039	7/16	2	3-1/2	Left	\$21.24
62040	1/2	2	3-1/2	Left	\$21.24
62041	3/16	3	4-1/2	Right	\$21.24
62043	9/32	3	4-1/2	Right	\$21.24
62045	11/32	3	4-1/2	Right	\$24.34
62047	25/64	3	4-1/2	Right	\$24.34
62048	7/16	3	4-1/2	Right	\$27.27
62049	29/64	3	4-1/2	Right	\$24.34
62054	1/2	3	4-1/2	Right	\$63.77
62055	1	3	4-1/2	Right	\$65.94
62056	3/16	3	4-1/2	Left	\$21.24
62057	1/4	3	4-1/2	Left	\$21.24
62058	9/32	3	4-1/2	Left	\$21.24
62059	5/16	3	4-1/2	Left	\$21.24
62060	11/32	3	4-1/2	Left	\$24.34
62061	3/8	3	4-1/2	Left	\$21.24
62062	25/64	3	4-1/2	Left	\$21.24
62063	7/16	3	4-1/2	Left	\$21.24
62064	29/64	3	4-1/2	Left	\$24.34
62066	9/16	3	4-1/2	Left	\$31.64
62068	3/4	3	4-1/2	Left	\$51.66
62069	1	3	4-1/2	Left	\$65.94

All Drills have a 7/16-14" Shank.

Identical to the No. 203 but made with Super Wear Steel. This steel requires less sharpening to maintain maximum production. The threaded shanks are treated specially for greater reliability.



**ALL QUANTITIES LIMITED
CALL FOR AVAILABILITY**

**Carbon-Steel Screw Shank Dowel Drills
No.203**

PART	DIA.	TWIST LENGTH	OAL	ROTATION DIRECTION	PRICE
62001	3/8	2	3-1/2	Right	\$16.21
62002	3/8	2	3-1/2	Left	\$16.21
62003	7/16	2	3-1/2	Left	\$16.21
62005	3/16	3	4-1/2	Right	\$16.21
62006	7/32	3	4-1/2	Right	\$16.21
62007	1/4	3	4-1/2	Right	\$16.21
62010	11/32	3	4-1/2	Right	\$16.21
62015	29/64	3	4-1/2	Right	\$16.21
62017	9/16	3	4-1/2	Right	\$18.05
62020	7/8	3	4-1/2	Right	\$25.59
62021	1	3	4-1/2	Right	\$25.59
62022	1/8	3	4-1/2	Left	\$15.25
62023	3/16	3	4-1/2	Left	\$15.25
62024	7/32	3	4-1/2	Left	\$15.25
62025	1/4	3	4-1/2	Left	\$15.25
62026	5/16	3	4-1/2	Left	\$15.25
62027	11/32	3	4-1/2	Left	\$15.25
62028	3/8	3	4-1/2	Left	\$15.25
62029	7/16	3	4-1/2	Left	\$15.25
62030	1/2	3	4-1/2	Left	\$15.25

All Drills have 7/16-14" Shank.

These drills feature outlining spurs and brad points. They are the most commonly used drills for dowel hole boring. Made of the finest carbon tool steel, they are heat treated and precision ground to exacting standards. Round shoulder has pin hole for easy removal from machines.



**Super Wear Steel Screw Shank Dowel Drills
(No. X204)**

PART	DIA.	TWIST LENGTH	OAL	ROTATION DIRECTION	PRICE
62095	3/8	3	4-1/2	Right	\$26.08
62096	7/16	3	4-1/2	Right	\$20.34
62097	3/8	3	4-1/2	Left	\$26.50
62098	7/16	3	4-1/2	Left	\$20.34

Taper Head drill point accurately ground to insure fast smooth boring. The shanks of all tools are relatively soft to facilitate removal from chuck in event of breakage. Used where exit hole must be clean.



FOREST CITY

★★★Note: *Forest City* is out of business and we still have parts in stock. Meanwhile, we have integrated *ComSurge* for the future replacement for *Forest City's* parts listed below.★★★

**Steel Screw Shank Dowel Drills
Super Wear™ No. X203B**

PART	DIA.	TWIST LENGTH	OVERALL LENGTH	ROTATION DIRECTION	PRICE
62070	3/16	1-3/4	4-1/2	Right	\$20.83
62074	25/64	1-3/4	4-1/2	Right	\$23.87
62075	7/16	1-3/4	4-1/2	Right	\$20.83
62076	1/2	1-3/4	4-1/2	Right	\$20.83
62077	3/16	1-3/4	4-1/2	Left	\$23.87
62078	1/4	1-3/4	4-1/2	Left	\$20.83
62079	5/16	1-3/4	4-1/2	Left	\$20.83
62080	3/8	1-3/4	4-1/2	Left	\$20.83
62081	25/64	1-3/4	4-1/2	Left	\$23.87
62082	7/16	1-3/4	4-1/2	Left	\$18.75
62083	1/2	1-3/4	4-1/2	Left	\$20.83

All Drills have a 7/16-14" Shank.

Designed primarily for the Bell 24 Double End Miter and Boring Machine. These tools can be used on any other boring machine where "Run-Out" has become a problem. The extended shaft insures rigidity especially on small diameter tools.



**1/2" x 2" Shank Carbon Steel Brad Point
Spur Machine Drills No. 200**

PART	FORMER part	DIA.	TWIST LENGTH	OVERALL LENGTH	PRICE
62115	--	1/8	3	5	\$10.53
62116	--	5/32	3	5	\$10.53
62117	--	3/16	3	5	\$10.53
62118	--	7/32	3	5	\$10.53
62119	--	1/4	3	5	\$10.53
62120	--	17/64	3	5	\$10.53
62121	--	9/32	3	5	\$10.53
62122	--	5/16	3	5	\$10.53
62123	--	11/32	3	5	\$10.53
62125	--	25/64	3	5	\$12.33
62127	--	7/16	3	5	\$10.53
62128	--	15/32	3	5	\$10.53
62130	--	5/8	3	5	\$15.09
62131	--	3/4	3	5	\$16.40
62132*	--	1/8	4	6	\$10.53
62133	--	5/32	4	6	\$10.53
62134	--	3/16	4	6	\$10.53
62135	--	7/32	4	6	\$10.53
62136	--	1/4	4	6	\$10.53
62137	--	17/64	4	6	\$10.53
62138	--	9/32	4	6	\$10.53
62139	--	19/64	4	6	\$10.53
62140	--	5/16	4	6	\$10.53
62141	--	11/32	4	6	\$10.53
62143	--	25/64	4	6	\$12.33
62145	--	7/16	4	6	\$11.93
62146	--	29/64	4	6	\$13.51
62147	--	15/32	4	6	\$10.53
62150	BP 562	9/16	4	6	\$14.07
62151	--	19/32	4	6	\$14.07
62154	--	11/16	4	6	\$15.53
62155	--	3/4	4	6	\$14.76
62156	--	25/32	4	6	\$18.82
62157	--	13/16	4	6	\$20.28
62160	BP 1000	1	4	6	\$28.02
62161	--	1-1/16	4	6	\$34.61
62162	--	1-1/8	4	6	\$35.32
62163	--	1-1/4	4	6	\$41.74

All Drills have a 1/2" Shank.

Widely used for cross-grain boring and other work requiring smooth, accurate holes. Head, twist, and shank are ground after hardening for accuracy. Two outlying spurs cut in advance of the chip lifter.



Carbide Tipped Screw Shank Dowel Drills No. 203CT

PART	DIA.	TWIST LENGTH	OVERALL LENGTH	ROTATION DIRECTION	PRICE
62099	1/4	2	3-1/2	Right	\$48.80
62100	5/16	2	3-1/2	Right	\$48.80
62101	3/8	2	3-1/2	Right	\$48.80
62102	7/16	2	3-1/2	Right	\$48.80
62103	1/4	3	4-1/2	Right	\$48.80
62107	7/16	3	4-1/2	Right	\$58.46
62109	1/4	3	4-1/2	Left	\$58.49
62110	5/16	3	4-1/2	Left	\$58.49
62111	3/8	3	4-1/2	Left	\$58.49
62112	25/64	3	4-1/2	Left	\$58.49
62113	7/16	3	4-1/2	Left	\$70.90
62528	6 mm	3	4-1/2	Right	\$52.11
62529	6 mm	3	4-1/2	Left	\$52.11
62530	8 mm	3	4-1/2	Right	\$52.11
62531	8 mm	3	4-1/2	Left	\$52.11
62533	10 mm	3	4-1/2	Left	\$59.72

All Drills have a 7/16-14" Shank.



**CARBON-STEEL ADJUSTABLE COUNTER-SINKS
WITH 7/16-14 THREADED SHANKS (No. 121V)**

PART	DIA.	TWIST LENGTH	OVERALL LENGTH	ROTATION	PRICE
62257	3/8"	2-1/2"	1-1/2"	Right	\$28.71
62258	1/2"	2-1/2"	1-1/2"	Right	\$28.71
62259	3/8"	2-1/2"	1-1/2"	Left	\$28.71
62260	1/2"	2-1/2"	1-1/2"	Left	\$28.71

Designed for Root, Bell, and similar boring machines requiring tools with threaded shanks. For seating flat head screws. Use with high speed steel centerdrills.

Note: Centerdrills not included with counterbores and countersinks.



CALL FOR AVAILABILITY

★★★Note: *Forest City* is out of business and we still have parts in stock. Meanwhile, we have integrated *ComSurge* for the future replacement for *Forest City*'s parts listed below.★★★

Forest City

Carbide-Tipped Countersinks No. M125

PART	ROTATION DIRECTION	PRICE
62235	Right	\$41.96
62237	Left	\$41.96



For use with M200 and M201 drills. Designed to chamfer holes for easier insertion of hardware or dowels. Fastens to shank with set screw. **For drill size 5 to 10, inside diameter 10, outside diameter 20, overall length 16.5.**

1/2" x 2" 82° Carbon-Steel Countersinks & Adjustable Counterbores No. 122V

part	COUNTERSINK SIZE	DRILL SIZE	PRICE
62283	3/8	5/32	\$24.81
62285	7/16	3/16	\$24.81
62286	7/16	7/32	\$24.81
62287	1/2	1/8	\$24.81
62288	1/2	5/32	\$24.81
62289	1/2	3/16	\$24.81
62290	1/2	7/32	\$24.81
62291	1/2	1/4	\$24.81

All Countersinks have a 2-1/2" Twist Length and 4-1/2" Overall Length.

Designed for seating flat head screws. Double-fluted twist with wide channels for easy chip clearances. Drill is held by split and set screw. Use with Drill Numbers X122D and X122B. Center drills not included.



Adjustable Counterbores No. 123

PART	COUNTERBORE SIZE	DRILL SIZE	STYLE	OVERALL LENGTH	PRICE
62302	1/2	3/16	B		\$13.11
62303*	1/2	7/32	B		\$13.11
62304	1/2	1/4	B		\$13.24
62305	5/8	1/4	A	2	\$34.93
62306	5/8	5/16	A	2	\$28.49
62308	3/4	5/16	A	2	\$31.23
62309	7/8	5/16	A	2	\$36.70
62311	7/8	7/16	A	2	\$36.70
62314	1	1/2	A	2	\$45.50
62315	1-1/8	1/2	A	2	\$48.39
62316	1-1/4	1/2	A	2	\$56.37
62317	1-3/8	1/2	A	2	\$60.99

Extension-lip head bores smooth, flat-bottomed holes. Set screws hold counterbore. Used in portable drills for ability to chuck up on smaller primary drill or center drills. Use with drill numbers X122D or 200 Series. Center drills not included.



Style A: 5/8 x 1-1/2



Style B: 3/8 x 1-1/2

Carbon-Steel Adjustable Counterbores No. 121

PART	COUNTERBORE SIZE	DRILL SIZE	ROTATION DIRECTION	PRICE
62250	1/2	3/16	Right	\$30.43
62251	1/2	7/32	Right	\$30.43
62252	1/2	1/4	Right	\$30.43
62253	3/8	3/16	Left	\$30.43
62254	1/2	3/16	Left	\$30.43
62255	1/2	7/32	Left	\$30.43

All Counterbores have a 7/16-14" Threaded Shank, 2-1/2" Twist Length and 4-1/2" Overall Length.

Designed for Root, Bell, etc. requiring tools with threaded shanks. For flat bottomed holes. Use right or left hand part number for X124D or X124B straight shank drills.



1/2" x 2" Carbon Steel Adjustable Counterbores No. 122

PART	COUNTERBORE SIZE	DRILL SIZE	TWIST LENGTH	OVERALL LENGTH	PRICE
62265	7/16	7/32	2-1/2	4-1/2	\$19.27
62266	1/2	1/8	2-1/2	4-1/2	\$19.27
62267	1/2	5/32	2-1/2	4-1/2	\$19.27
62271	9/16	3/16	2-1/2	4-1/2	\$25.46
62272	9/16	1/4	2-1/2	4-1/2	\$25.46
62273	5/8	3/16	2-1/2	4-1/2	\$27.07
62274	5/8	1/4	2-1/2	4-1/2	\$27.07
62275	5/8	9/32	2-1/2	4-1/2	\$27.07
62276	5/8	5/16	2-1/2	4-1/2	\$27.07
62277	3/4	3/16	2-1/2	4-1/2	\$32.99
62278	3/4	1/4	2-1/2	4-1/2	\$32.99
62279	3/4	9/32	2-1/2	4-1/2	\$32.99
62280	3/4	5/16	2-1/2	4-1/2	\$32.99
62281	3/4	3/8	2-1/2	4-1/2	\$32.99

Bores smooth, flat-bottomed holes. Double-fluted twist with wide channels for easy chip clearance. Held by split shank and set screw. Use with Drill X122D & X122B. Center drills not included.



1/2" x 2" Carbide-Tipped Adjustable Counterbores No. 122CT

PART	COUNTERBORE SIZE	DRILL SIZE	PRICE
62293	1/2	3/16	\$55.34
62294	1/2	7/32	\$55.34

All Counterbores have a 2-1/2" Twist Length and 4-1/2" Overall Length.

Bores smooth, flat-bottomed holes. Double-fluted twist with wide channels for easy chip clearance. Drill is held by split shank and set screw. Carbide-tipped for longer life in particle boards, fiber boards, and plastics. Use with drill numbers X122D and X122B. Center drills not included.



FOREST CITY

★★★ Note: *Forest City* is out of business and we still have parts in stock. Meanwhile, we have integrated *ComSurge* for the future replacement for *Forest City's* parts listed below. ★★★

1/2" x 2" Carbide-Tipped Adjustable Countersinks No. 122VCT

PART	COUNTERSINK SIZE	DRILL SIZE	PRICE
62296	3/8	3/16	\$59.39
62297	1/2	3/16	\$59.32
62298	1/2	7/32	\$65.36
62299	1/2	1/4	\$70.17

All Countersinks have a 2-1/2" Twist Length and 4-1/2" Overall Length.

Designed for seating flat head screw. Double-fluted twist with wide channels for easy chip clearance. Drill is held by split shank and set screw. Carbide-tipped for longer life in particle board, fiber board, and plastics. Use with drill numbers X122D and X122B.



Carbide-Tipped Adjustable Countersinks No. 125CT

PART	DRILL SIZE	PRICE
62338	3/16	\$45.34
62339	7/32	\$45.34
62340	1/4	\$51.72

All Countersinks have a 1/2" Countersink Size and 1-1/2" Overall Length.

Beveled head countersinks for flat-head wood screws. Socket set screw holds countersink firmly in place. Designed for use primarily in portable drills. Use with drill numbers X124D & X124B or 200 & 200A series drills. **Discontinued. Quantities limited.**



High-Speed Steel Straight Shank Center Drills No. X122D8

PART	DRILL SIZE	SHANK SIZE	ROTATION DIRECTION	PRICE
62423	3/16	3/16	Right	\$6.78
62424	7/32	7/32	Right	\$7.83
62425	1/4	1/4	Right	\$7.96

All Drills have a 3-1/2" Twist Length and 8" Overall Length.

Similar to number X122D drills, except overall length is 8". Shank is same diameter as drill. For use with countersinks and counterbores.



High-Speed Steel Straight Shank Brad Point Center Drills No. X122B8

PART	DRILL SIZE	SHANK SIZE	ROTATION DIRECTION	PRICE
62382	3/16	3/16	Right	\$10.41
62384	1/4	1/4	Right	\$10.81

All Drills have a 3-1/2" Twist Length and 8" Overall Length. Designed for use with number 122EL adjustable counterbore. Also for counterboring in table aprons. Can also be used in regular style num-



1/2 X 2 INCH SHANK SUPER WEAR STEEL BRAD POINT SPUR MACHINE DRILLS (No. X200)

PART	DIA.	TWIST LENGTH	OVERALL LENGTH	PRICE
62164	3/16"	3"	5"	\$18.50
62165	1/4"	3"	5"	\$18.50
62166	9/32"	3"	5"	\$18.50
62168	11/32	3"	5"	\$18.50
62169	" 3/8"	3"	5"	\$18.50
62170	7/16"	3"	5"	\$18.50
62171	1/2"	3"	5"	\$18.50
62172	1/4"	4"	6"	\$18.50
62173	9/32"	4"	6"	\$18.50
62174	5/16"	4"	6"	\$18.50
62175	11/32	4"	6"	\$18.50
62176	" 3/8"	4"	6"	\$18.50
62178	7/16"	4"	6"	\$18.50
62179	1/2"	4"	6"	\$18.50
62183	11/16	4"	6"	\$23.07
62184	" 3/4"	4"	6"	\$23.07
62185	13/16"	4"	6"	\$35.78
62186	7/8"	4"	6"	\$35.78
62188	1"	4"	6"	\$35.78

CARBIDE TIPPED BRAD POINT SPUR MACHINE DRILLS (200CT) with 1/2" SHANK (For drilling plastics, laminates, chip core, etc.)

PART	DIA.	TWIST LENGTH	OVERALL LENGTH	PRICE
62189	1/4"	3"	5"	\$47.94
62190	5/16"	3"	5"	\$47.94
62191	3/8"	3"	5"	\$47.94
62192	7/16"	3"	5"	\$56.34
62193	1/2"	3"	5"	\$61.22
62194	5/8"	3"	5"	\$73.05
62195	3/4"	3"	5"	\$93.03
62196	1/4"	4"	6"	\$47.93
62197	5/16"	4"	6"	\$47.93
62198	3/8"	4"	6"	\$47.93
62199	7/16"	4"	6"	\$54.36
62201	5/8"	4"	6"	\$71.85
62202	3/4"	4"	6"	\$95.62

Same as No. 200 Drills except made of Super Wear Steel for added drill life in tough applications. Twist is specially ground to give maximum chip clearance.



1/2 * 2 Inch Shank Carbon-Steel Adjustable Countersinks (No. 124)

PART	COUNTERSINK SIZE	DRILL SIZE	Overall Length	PRICE
62319	3/8	3/16	3	\$18.95
62320	1/2	3/32	3	\$18.95
62321	1/2	1/8	3	\$18.95
62322	1/2	5/32	3	\$18.95
62323	1/2	3/16	3	\$18.95
62324	1/2	7/32	3	\$18.95
62325	1/2	1/4	3	\$18.95

FOREST CITY

★★★Note: *Forest City* is out of business and we still have parts in stock. Meanwhile, we have integrated *ComSurge* for the future replacement for *Forest City's* parts listed below.★★★

Carbide-Tipped Counterbore with High-Speed Steel Drill No. 135CT

PART	SIZE	OVERALL SPIRAL LENGTH	PRICE
135 SP Counterbore with High-Speed Drill			
61356	3/8 x 29	4	\$40.49

REPLACEMENT CENTER DRILLS

62358 Cobalt	29	2-7/8	\$7.14
--------------	----	-------	--------

*Center drill included with counterbore.

Designed for face frame boring machine. Can also be used on Ritter and Evans Rotork Machines.



High-Speed Steel Brad Point Center Drill No. X122-Bedlock

PART	DRILL & SHANK SIZE	TWIST LENGTH	OVERALL LENGTH	ROTATION DIRECTION	PRICE
62381	19/64	3-1/2	6	Right	\$11.34

Popular for cross-grain boring and other general work requiring smooth, accurate holes. Head, twist, and shank are ground after hardening.



High-Speed Steel Straight Shank Brad Point Center Drills No. X124B

part	DRILL & SHANK SIZE	ROTATION DIRECTION	PRICE
62403	5/32	Right	\$9.74
62404	3/16	Right	\$9.74
62405	7/32	Right	\$9.74
62406	1/4	Right	\$10.71
70522	3/16	Left	\$14.52
70523	7/32	Left	\$14.52
70524	1/4	Left	\$13.07

All Drills have 2-1/4" Twist Length & 4-1/2" Overall Length.



High-Speed Steel Straight Shank Taper Point Center Drills No. X122T

PART	DRILL & SHANK SIZE	PRICE
62461	3/16	\$13.46
62462	7/32	\$14.87

All Drills have a 2-1/4" Twist Length and 6" Overall Length.

For boring tapered holes for wood screws. Twist is tapered to correspond to threaded portion of screw.

No. X124T

PART	DRILL & SHANK SIZE	PRICE
62465	3/16	\$12.59
62466	7/32	\$14.74
62467	1/4	\$14.39

All Drills have a 2-1/4" Twist Length and 4-1/2" Overall Length.

Similar to No. X122T drills, except 4-1/2" long overall.

Carbon-Steel Adjustable Countersinks No. 125

PART	COUNTERSINK SIZE	DRILL SIZE	PRICE
62327	1/2	1/8	\$11.36
62328	1/2	9/64	\$10.22
62329	1/2	5/32	\$11.36
62330	1/2	11/64	\$11.36
62332	1/2	7/32	\$11.36
62334	5/8	1/4	\$17.04
62335	5/8	5/16	\$17.04
62336	3/4	5/16	\$17.04
62337	3/4	3/8	\$16.62

All Countersinks have a 1-1/2" Overall Length.

Beveled head countersinks for flat-head wood screws. Socket set screw holds countersink firmly in place. Used primarily in portable drills. Use with drill numbers X124D & X124B or 200 & 200A series drills.



Carbon-Steel Multi-Spur™ Counterbores No. 120

PART	COUNTERBORE SIZE	BORE SIZE	PRICE
62345	1-1/8	1/2	\$50.81
62346	1-1/4	1/2	\$51.67
62347	1-3/8	1/2	\$54.99
62348	1-1/2	1/2	\$60.22
62349	1-5/8	1/2	\$65.07
62350	1-3/4	1/2	\$69.77
62351	1-7/8	1/2	\$72.72
62352	2	1/2	\$75.11
62353	2-1/8	1/2	\$77.51
62354	2-1/4	1/2	\$82.27
62355	2-1/2	1/2	\$95.09

An adjustable counterbore cutter designed to fit any drill or bit 1/2" diameter or large. Cutter is held firmly in place with set screw on 1/2" diameter shank. Drill bit not included.



VIX BITS SELF CENTERING BITS (No. 137)

Product Number	Size	Description	Price
62365	13/64"	14 with 1/4" Shank	\$63.00
REPLACEMENT DRILLS			
62370	13/64"	Replacement Bit	\$9.45
62372	1/4"	Replacement Bit	\$8.00

For accurately centering and drilling holes for Hinges, Striker Plates, Door Butts, Window Pulls, and all hardware using screws.



FOREST CITY

★★★Note: *Forest City* is out of business and we still have parts in stock. Meanwhile, we have integrated *ComSurge* for the future replacement for *Forest City's* parts listed below.★★★

High-Speed Steel Straight Shank Brad Point Center Drills No. X122B

PART	DIA.	TWIST LENGTH	OVERALL LENGTH	ROTATION DIRECTION	PRICE
62385	1/8	2-1/4	6	Right	\$7.83
62386	5/32	2-1/4	6	Right	\$7.83
62387	3/16	2-1/4	6	Right	\$8.08
62388	7/32	2-1/4	6	Right	\$7.87
62389	1/4	2-1/4	6	Right	\$8.08
62390	9/32	2-1/4	6	Right	\$12.88
62391	19/64	2-1/4	6	Right	\$12.88
62392	5/16	2-1/4	6	Right	\$13.33
62393	3/8	2-1/4	6	Right	\$13.33
62394	3/16	2-1/4	6	Left	\$10.87
62395	7/32	2-1/4	6	Left	\$10.87
62396	1/4	2-1/4	6	Left	\$11.29

For use with all types of adjustable counterbores and countersinks or straight boring jobs. Two outlining spurs and brad point produce accurate holes. High-speed steel for extra tool life.



High-Speed Steel Straight Shank Center Drills No. X122D7

PART	DRILL & SHANK SIZE	TWIST LENGTH	OVERALL LENGTH	PRICE
62421	3/16	3-1/2	7	\$7.12
62422	7/32	3-1/2	7	\$7.48

Similar to No. X122D drills, except overall length is 7". Shank is same diameter as drill. For use with countersinks and counterbores.



1/4" x 4-1/2" Shank Carbon-Steel Brad Point Center Drills No. 122C

PART	DRILL SIZE	PRICE
62469	5/16	\$14.13
62470	3/8	\$14.13
62471	7/16	\$14.13
62472	1/2	

All Drills have a 1-1/2" Twist Length and 6" Overall Length.
Used with countersinks and counterbores with 1/4" hole. Works well in applications where countersink and center drill diameters are too close for a standard configuration center drill.



No. X122D

PART	DIA.	TWIST LENGTH	OVERALL LENGTH	PRICE
62426	3/32	2-1/4	6	\$5.89
62427	1/8	2-1/4	6	\$5.89
62428	5/32	2-1/4	6	\$5.89
62429	11/64	2-1/4	6	\$5.89
62431	7/32	2-1/4	6	\$6.87
62433	9/32	2-1/4	6	\$10.26
62434	5/16	2-1/4	6	\$11.66
62435	3/8	2-1/4	6	\$12.87

Similar to No.122D drills, except made with high-speed steel for extra long tooth life. For use with countersinks and counterbores.

118° Point Steel General Purpose Jobbers-Length Straight Twist Drills No. X10

PART	DIA.	OVERALL LENGTH	APPROX TWIST LENGTH	PRICE
62498	3/64	1-3/4	3/4	\$1.45
62499	1/16	1-7/8	7/8	\$1.48
62500	5/64	2	1	\$1.48
62501	3/32	2-1/4	1-1/4	\$1.48
62502	7/64	2-5/8	1-1/2	\$1.67
62503	1/8	2-3/4	1-5/8	\$1.71
62504	9/64	2-7/8	1-3/4	\$1.76
62506	11/64	3-1/4	2-1/8	\$1.94
62507	3/16	3-1/2	2-5/16	\$2.19
62508	13/64	3-5/8	2-7/16	\$2.42
62509	7/32	3-3/4	2-1/2	\$2.75
62510	15/64	3-7/8	2-5/8	\$2.95
62511	1/4	4	2-3/4	\$3.13
62512	17/64	4-1/8	2-7/8	\$3.66
62513	9/32	4-1/4	2-15/16	\$3.79
62514	19/64	4-3/8	3-1/16	\$4.40
62515	5/16	4-1/2	3-3/16	\$4.88
62516	21/64	4-5/8	3-5/16	\$5.37
62517	11/32	4-3/4	3-7/16	\$6.01
62518	23/64	4-7/8	3-1/2	\$6.72
62519	3/8	5	3-5/8	\$6.94
62521	13/32	5-1/4	3-7/8	\$8.11
62522	27/64	5-3/8	3-15/16	\$8.99
62523	7/16	5-1/2	4-1/16	\$9.33
62526	31/64	5-7/8	4-3/8	\$11.62
62527	1/2	6	4-1/2	\$11.88



No. X124D

PART	DRILL & SHANK SIZE	PRICE
62450	3/32	\$8.34
62451	1/8	\$8.34
62452*	9/64	\$8.34
62453	5/32	\$8.34
62454	11/64	\$8.34
62455	3/16	\$6.18
62456	7/32	\$9.42
62457	1/4	\$9.85
62458	9/32	\$10.46
62459	5/16	\$10.70
62460	3/8	\$12.88

All Drills have a 2-1/4" Twist Length and 4-1/2" Overall Length.
For use with No. 124 Countersinks.



BORING CHUCKS (NO. 5)

Furnished with 7/16"-14 threaded shank to accept straight shank drills.



Product Number	Drill Size	Outside Diameter	Overall Length	Rotation Direction	Price
62478	9/32"	5/8"	1-3/4"	Right	\$21.41
62483	10mm	5/8"	1-3/4"	Right	\$21.41
62494	10mm	5/8"	1-3/4"	Left	\$21.41

FOREST CITY

★★★Note: *Forest City* is out of business and we still have parts in stock. Meanwhile, we have integrated *ComSurge* for the future replacement for *Forest City's* parts listed below.★★★

Hollow Mortising Chisels No. 27

PART	DIAMETER	MORTISING DEPTH	PRICE
62618	1/4	1-7/8	\$59.76
62619	5/16	1-7/8	\$67.61
62620	3/8	1-7/8	\$70.27
62621	1/2	1-7/8	\$74.06

All Chisels have a 5/8" Shank Diameter and 4-1/4" Overall Length.

Makes square mortises in one stroke and oblong mortises with succeeding strokes. 2-3/4" blade. For shallow mortises. Chisels & Bits are sold separately. **Designed to be used with No. 1-27, shown below.**



Carbon-Steel Hollow Chisel Bits No. 1-27

PART	DIAMETER	SHANK DIAMETER	PRICE
62622	1/4	3/16	\$24.18
62623	5/16	1/4	\$24.18
62624	3/8	19/64	\$20.72
62625	1/2	19/64	\$26.34

All Chisels have a 3-1/4 Mortising Length, 1-7/8 Twist Length and 8" Overall Length.

For 2-3/4" blade hollow chisels. Bits have knife edged spurs and no point.



Delta Model 14-651 Mortising Chisel & Bit Set

PART	DIAMETER	SHANK CHISEL-BIT	OVERALL LENGTH CHISEL-BIT	PRICE
80101	1/4	5/8 3/16	4/14 7-5/16	\$106.81
80102	5/16	5/8 1/4	4/14 7-5/16	\$101.90
80103	3/8	5/8 19/64	4/14 7-5/16	\$110.89
80104	1/2	5/8 19/64	4/14 7-5/16	\$120.81

All Mortising Depths 1-7/8"

JET MODEL JBM-5 MORTISING CHISEL & BIT SET

PART	DIAMETER	SHANK CHISEL-BIT	OVERALL LENGTH CHISEL-BIT	PRICE
80201	1/4"	5/8" 3/16"	4-1/4" 8-1/4"	\$96.13
80202	5/16"	5/8" 1/4"	4-1/4" 8-1/4"	\$98.91
80203	3/8"	5/8" 19/64"	4" 8-1/4"	\$99.80
80204	1/2"	5/8" 19/64"	4-1/4" 8-1/4"	\$108.73

Hollow Chisel Replacement Bits for Delta Model 14-651 (No. 1-28)

PART	DIA.	SHANK DIA.	MORTISING DEPTH	TWIST LENGTH	OVERALL LENGTH	PRICE
62609D	1/4	3/16	1-3/4	3-1/4	8	\$23.93
62610D	5/16	1/4	1-3/4	3-1/4	8	\$23.93
62611D	3/8	19/64	3	6	8	\$23.93
62612D	1/2	19/64	3	6	8	\$28.98

For 4" blade hollow chisels. Bits have knife edged spurs, no point.



Hollow Mortising Chisel No. 28

PART	DIA.	SHANK DIA.	MORTISING DEPTH	OVERALL LENGTH	PRICE
62602	1/4	5/8	1-7/8	5-1/2	\$67.62
62603	5/16	5/8	1-7/8	5-1/2	\$70.27
62604	3/8	5/8	3-1/4	5-1/2	\$71.12
62605	1/2	5/8	3-1/4	5-1/2	\$74.57
62606	5/8	3/4	3-1/4	5-1/2	\$104.57
62607	3/4	1-1/8	3-1/4	5-1/2	\$118.12
62608	1	1-1/8	3-1/4	5-1/2	\$129.48

Works on Delta Model 14-561 and Jet Model JBM-5.

For making square mortises in one stroke, and oblong mortises with each succeeding stroke. 4" blade, 5-1/2" overall length. 1/4" and 5/16" sizes have reinforced blade. Chisel and Bit are sold separately. Uses X1-28 chisel bit. **Designed to be used with No. 1-28, shown below.**



Carbon-Steel Hollow Chisel Bits No. 1-28

PART	DIA.	SHANK DIA.	SHANK LENGTH	TWIST LENGTH	OVERALL LENGTH	PRICE
62609	1/4	3/16	5-3/4	3-1/4	9	\$23.93
62610	5/16	1/4	5-3/4	3-1/4	9	\$23.93
62611	3/8	19/64	3	6	9	\$21.54
62612	1/2	19/64	3	6	9	\$28.98
62613	5/8	1/2	3	6	9	\$44.34
62614	3/4	1/2	3	6	9	\$37.41
62615	1	1/2	3	6	9	\$69.99

For 4" Blade Hollow Chisels. Bits have knife edged spurs, no point.



Carbide-Tipped Hollow Chisel Bits CT1-28

PART	DIA.	SHANK DIA.	MORTISING DEPTH	TWIST LENGTH	OVERALL LENGTH	PRICE
62617	3/4	1/2	3	6	9	\$79.57

Use on core, particle board. Use with 28, 30 Mortising Chisels.

Works on both Delta 14-561 and Jet JBM-5.

Super Wear™ Steel Hollow Chisel Bits X-28

PART	DIA.	SHANK DIA.	MORTISING DEPTH	TWIST LENGTH	OVERALL LENGTH	PRICE
62616	3/4	1/2	3	6	9	\$63.88

Use with 28, 30 Mortising Chisels. Super Wear Steel boosts life on hard wood. **Works on both Delta 14-561, Jet JBM-5.**

Hollow Chisel Replacement Bits for Jet Model JBM-5 (No. 1-28)

PART	DIA.	SHANK DIA.	MORTISING DEPTH	TWIST LENGTH	OVERALL LENGTH	PRICE
62609J	1/4	3/16	1-3/4	3-1/4	7-3/4	\$23.93
62610J	5/16	1/4	1-3/4	3-1/4	7-3/4	\$23.93
62611J	3/8	19/64	3	6	7-3/4	\$23.93
62612J	1/2	19/64	3	6	7-3/4	\$28.98

For 4" blade hollow chisels. Bits have knife edged spurs, no point.

FOREST CITY

★★★Note: *Forest City* is out of business and we still have parts in stock. Meanwhile, we have integrated *ComSurge* for the future replacement for *Forest City's* parts listed below.★★★

1/2" x2" Shank Carbon-Steel Plug Cutters No. 600P

PART	PLUG SIZE	CUTTER BARRELS	OVERALL LENGTH	PRICE
62878	5/8	2	4-3/8	\$68.02
62880*	3/8	2	4-3/8	\$68.02
62882*	1-1/4	2	4-3/8	\$97.51
62883	1-1/2	2	4-3/8	\$139.38
62884*	1-3/4	2	4-3/8	\$172.85
62885*	2	2	4-3/8	\$197.24

Designed to cut a true-sized plug under most conditions. More effective at clearing chips than No. 140 due to mul-tiple spiral flutes. **For Hard Wood.**



1/2" x 2" Shank Carbon-Steel Spiral Plug Cutters No. 140

PART	PLUG SIZE	CUTTER BARRELS	OVERALL LENGTH	PRICE
62872	1/2	2-1/8	4-3/8	\$53.82
62874	3/4	2-1/8	4-3/8	\$60.36
62875	1	2-1/8	4-3/8	\$73.08

This one-piece Plug Cutter is designed to cut cross-grain plugs or end-grain dowels up to 2" in length. Plugs up to 1" thick are easily cleared through the 1-1/8" opening. **For Soft Wood.**



Carbide-Tipped Drills # 811CT

PART	DIAMETER	PRICE
62797	1	\$127.88
62798	1-1/8	\$127.88
62799	1-1/4	\$127.88
62800	1-3/8	\$127.88
62801	1-1/2	\$130.59
62802	1-5/8	\$149.66
62803	1-3/4	\$152.31
62804	1-7/8	\$174.23
62805	2	\$174.23
62806	2-1/4	\$174.23
62807	2-1/4	\$204.03
62808	2-1/2	\$217.75
62809	2-3/4	\$244.90
62810	3	\$312.90

All Bits have 1/2" Shank Diameter and 6" Nominal Overall Length.



Bores clean, accurate holes in plastic laminates and wood. Spur outlines the hole before the chip lifters plane the material; helps prevent cracked edges. Includes solid carbide point.

CHUCKS

Quick Change Chucks work with ALL 1/4" Hex Shank Tools.

Product Number	Description	Price
62399	All Hex 1/4" Chuck w/ 3/8" Shank	\$11.50
62400	1/4" QC Chuck, Replaces 3/8"-24 Female Thread Permanent Keyed & Keyless Chucks	\$16.75



P/N 62399



P/N 62400

Brad Point Double Spur Machine Bits No.107

PART	DIAMETER	TWIST LENGTH	OVERALL LENGTH	PRICE
62627	3/8	4	6-1/4	\$53.69
62635	3/8	6	8-1/4	\$54.41
62636	7/16	6	8-1/4	\$54.41
62641	3/4	6	8-1/4	\$66.59
62643	7/8	6	8-1/4	\$74.85
62645	1	6	8-1/4	\$79.16

All Bits have 1/2" Shank Diameter and 2-1/4" Shank Length. These bits have two outlining spurs, supported by side lips, for cutting smooth holes in soft or hard woods, cross, or end grain. The Brad Point allows fingertip control while boring.



Screw Point Double Spur Machine Bits No.150

PART	DIAMETER	TWIST LENGTH	LENGTH	OVERALL PRICE
62655	3/8	4	6-1/4	\$40.64
62656	7/16	4	6-1/4	\$40.64
62657	1/2	4	6-1/4	\$40.64
62658	5/8	4	6-1/4	\$48.39
62659	3/4	4	6-1/4	\$60.87
62660	7/8	4	6-1/4	\$62.06
62661	1	4	6-1/4	\$66.23
62663	3/8	6	8-1/4	\$40.64
62664	7/16	6	8-1/4	\$42.99
62665	1/2	6	8-1/4	\$42.99
62666	9/16	6	8-1/4	\$49.14
62667	5/8	6	8-1/4	\$51.19
62668	11/16	6	8-1/4	\$57.53
62669	3/4	6	8-1/4	\$63.13
62670	13/16	6	8-1/4	\$69.44
62671	7/8	6	8-1/4	\$69.44
62672	15/16	6	8-1/4	\$74.13
62673	1	6	8-1/4	\$76.28

All Bits have 1/2" Shank Diameter and 2-1/4" Shank Length.

Same as No. 107 except furnished with medium pitch screw point.



HSS STRAIGHT SHANK TAPER POINT LONG LENGTH CENTER DRILLS

Product Number	Diameter	Dec. Equiv.	Length Overall	Length of Twist	Price
62703	9/64	0.141	5-3/8	3	\$16.88
62705	11/64	0.172	5-3/4	3-3/8	\$16.16
62707	13/64	0.203	6	3-5/8	\$19.60
62708	7/32	0.219	6	3-5/8	\$20.60



FOREST CITY

★★★Note: *Forest City* is out of business and we still have parts in stock. Meanwhile, we have integrated *ComSurge* for the future replacement for *Forest City's* parts listed below.★★★

Multi-Spur Machine Bits No. 149

PART	FORMER part	DIAMETER	PRICE
62736	--	1/2	\$34.27
62737	--	9/16	\$34.27
62740	S750	3/4	\$31.94
62741	--	13/16	\$31.94
62746	S1125	1-1/8	\$35.41
62747	--	1-3/16	\$35.41
62748	S1250	1-1/4	\$35.41
62749	--	1-5/16	\$37.21
62750	S1375	1-3/8	\$37.21
62751	--	1-7/16	\$37.21
62752	S1500	1-1/2	\$37.21
62755	--	1-11/16	\$42.61
62756	S1750	1-3/4	\$42.61
62757	--	1-13/16	\$46.53
62759	--	1-15/16	\$46.53
62762	S2250	2-1/4	\$56.13
62763	--	2-3/8	\$59.19
62764	S2500	2-1/2	\$62.91
62765	--	2-5/8	\$64.49
62766	S2750	2-3/4	\$68.06
62767	--	2-7/8	\$76.00
62768	S3000	3	\$99.22
62773	--	4	\$216.22
62774	--	3-1/8	\$194.20
62775	--	3-1/4	\$195.33
62776	--	3-1/2	\$199.74
62777*	--	3-3/4	\$239.99
62778	--	4	\$262.18

All Bits have a 1/2" Shank Diameter and 6" Overall Length.



- Works well across or with the grain.
- Excellent for boring overlapping holes or on close centers.
- Careful heat-treating assures tough, uniformly hard cutting edges
- Precision made and finished meaning uniform quality in every Multi-Spur.
- Brad point design for positive centering.

NOTE: 3-1/8", 3-1/4", 3-3/4", and 4" bits available with 1/2" shanks for light duty applications that do not overstress the shank. 1/2" shanks in larger diameter bits not recommended for medium or heavy duty applications. Bits 2-1/4" thru 3" furnished with a long 2-1/4" shaft and 1/2" x 2-3/4" shank.

Carbide-Tipped Multi-Spur Machine Bits No. 149CT

PART	DIAMETER	SHANK DIAMETER	PRICE
62779*	3/4	1/2	\$72.82
62781*	15/16	1/2	\$72.82
62783	1-1/16	1/2	\$72.82
62784	1-1/8	1/2	\$76.04
62785	1-3/16	1/2	\$76.04
62786	1-1/4	1/2	\$76.04
62787	1-5/16	1/2	\$81.36
62788	1-3/8	1/2	\$84.02
62789	1-7/16	1/2	\$86.01
62791	1-9/16	1/2	\$89.63
62793	1-3/4	1/2	\$92.71
62794	1-7/8	1/2	\$98.46
62795	2	1/2	\$104.53
62796	2-1/8	1/2	\$106.29
62812	2-3/8	1/2	\$112.94
62813	2-1/2	1/2	\$134.29
62814	2-5/8	1/2	\$125.93
62815	2-3/4	1/2	\$151.58
62817	3-1/4	3/4	\$208.82
62821	3-1/4	1/2	\$232.02
62822	3-1/2	1/2	\$257.59
62823	3-3/4	1/2	\$393.75

All Bits have a 6" Nominal Overall Length.
*Furnished with Carbide Tips on every other tooth.

NOTE: 3-1/8", 3-1/4", 3-3/4" and 4" bits available with 1/2" shanks for light duty applications that do not overstress the shank. 1/2" shanks in these larger diameter bits are not recommended for medium or heavy duty applications. Bits 2-1/4" through 3" furnished with 2-1/4" long reinforced shaft and 1/2" x 2-3/4" shank. 3-1/8" and larger will have 2 chiplifters and replaceable points.



5-PC. Brad Point Wood Boring Drill Set 62540 (Contains the following parts) \$48.20

PART	Former Part No.	Diameter	Shank LENGTH	Shank Diameter	TWIST LENGTH	OVERALL LENGTH
62541	BP 250	1/4	1-1/4	1/4	3-1/8	4-3/8
62542	BP 312	5/16	1-1/4	5/16	3-1/8	4-3/8
62543	BP 375	3/8	1-1/4	3/8	3-1/8	4-3/8
62544	BP 437	7/16	1-1/4	3/8	3-1/8	4-3/8
62545	BP 500		1-1/4	3/8	3-1/8	4-3/8

8-PC. Brad Point Wood Boring Drill Set 62554 (Contains the following parts) \$79.95

PART	Diameter	Shank LENGTH	Shank Diameter	TWIST LENGTH	OVERALL LENGTH
62541	1/4	1-1/4	1/4	3-1/8	4-3/8
62542	5/16	1-1/4	5/16	3-1/8	4-3/8
62543	3/8	1-1/4	3/8	3-1/8	4-3/8
62544	7/16	1-1/4	3/8	3-1/8	4-3/8
62545	1/2	1-1/4	3/8	3-1/8	4-3/8
62150	9/16	2	1/2	4	6
62152	5/8	2	1/2	4	6
62155	3/4	2	1/2	4	6

FOREST CITY

★★★Note: *Forest City* is out of business and we still have parts in stock. Meanwhile, we have integrated *ComSurge* for the future replacement for *Forest City's* parts listed below.★★★

1/4-Inch Shank Carving Roughers No. X421



PART	SIZE	TWIST	PRICE
63711	5/8	Right	\$17.62
63712	3/4	Right	\$19.42
63713	1	Right	\$27.39
63714	1/2	Left	\$16.88
63716	3/4	Left	\$19.42

These Super Wear Roughers are designed to give maximum life and ease of cutting stock to rough size on a multiple spin-dle carving machine.

Carbide-Tipped 3 Wing Drills No. 812CT

PART	DIAMETER	PRICE
62825*	1/2	\$98.12
62826*	9/16	\$98.12
62827*	5/8	\$98.12
62828	11/16	\$94.22
62829	3/4	\$94.22
62830	13/16	\$94.22
62831	7/8	\$94.22
62832	1	\$94.22
62833	1-1/8	\$94.22
62834	1-1/4	\$94.22
62835	1-3/8	\$123.93
62836	1-1/2	\$123.93
62837	1-5/8	\$123.93
62838	1-3/4	\$123.93
62839	1-7/8	\$152.88
62840	2	\$152.88
62841	2-1/8	\$152.88
62842	2-1/4	\$187.41
62843	2-1/2	\$187.41



All Bits have 1/2" Shank Diameter and 6" Overall Length.

* Reduced shank behind wings.

Designed to bore plastic Formica™ and tempered Masonite™ as well as abrasive materials and hard woods. Only 2" through 2-1/2" diameter are furnished with 2-1/4" long reinforced shaft.

ALL MEASUREMENTS ARE IN INCHES UNLESS NOTED OTHERWISE

High Speed Finished Ground Router Blanks No. X411



PART	CUTTING DIAMETER	CUTTING LENGTH	SHANK DIAMETER	PRICE
63021	3/4	1-1/2	1/2	\$55.55
63022	1-1/4	1-1/2	1/2	\$60.37

All Bits have Overall Lengths of 3"

CALL FOR AVAILABILITY

Super Wear™ Steel Screw Shank Dowel Drills No. X203J

PART	DIA.	TWIST LENGTH	OVERALL LENGTH	ROTATION DIRECTION	PRICE
62084	1/8	1-1/2	2-3/4	Right	\$20.83
62085	3/16	1-1/2	2-3/4	Right	\$20.83
62087	1/4	1-1/2	2-3/4	Right	\$20.83
62088	5/16	1-1/2	2-3/4	Right	\$20.83
62090	7/16	1/2	2-3/4	Right	\$20.83
62091	1/2	1-1/2	2-3/4	Right	\$20.83
62092	1/4	1-1/2	2-3/4	Left	\$20.83
62093	3/8	1-1/2	2-3/4	Left	\$20.83
62094	7/16	1-1/2	2-3/4	Left	\$20.83

All Drills have a 7/16-14" Shank.



Designed for use in J.S. Richardson Boring Machines, but can also be used in Root, Bell, Greenlee, and other machines using threaded spindles. Short length reduces run-out at tip of bit.

Vix Bits (No. 137)

PART	SIZE	DIA.	SCREW SIZE	DESCRIPTION	PRICE
63350	3	5/64	3, 4	1/4" Shank	\$15.60
63359	5	7/64	5, 6	1/4" Shank	\$13.80
63360	9	9/64	8, 9, 10	1/4" Shank	\$15.60
63352	12	11/64	12	1/4" Shank	\$63.00
63354	14	13/64	14, 16	1/4" Shank	\$63.00

REPLACEMENT PARTS

PART	SCREW SIZE	DIA.	DESCRIPTION	PRICE
63351	3	5/64	Drill-HSS	\$5.20
63361	5	7/64	Drill-HSS	\$5.40
63362	9	9/64	Drill-HSS	\$5.60
63353	12	11/64	Drill-HSS	\$9.45
63355	14	13/64	Drill-HSS	\$9.45

Designed accurately centering drilling holes for hinges. Striker Plates, Door Butts, Window Pulls and hardware using screws.



Center Drills

PART	DIAMETER	TWIST LENGTH	OVERALL LENGTH	ROTATION	PRICE
62373	19/64	2-1/4	6	Right	\$11.59
62375	3/8	2-1/4	6	Right	\$12.00
62379	1/4	2-1/4	6	Left	\$10.16
62407	3/32	2-1/4	6	Right	\$5.30
62408	1/8	2-1/4	6	Right	\$5.30
62409	5/32	2-1/4	6	Right	\$5.30
62410	11/64	2-1/4	6	Right	\$5.30
62412	7/32	2-1/4	6	Right	\$6.18
62413	1/4	2-1/4	6	Right	\$6.62
62414	9/32	2-1/4	6	Right	\$10.26
62415	5/16	2-1/4	6	Right	\$10.49
62416	11/32	2-1/4	6	Right	\$11.58
62442	7/32	2-1/4	4-1/2	Right	\$9.42
62443	1/4	2-1/4	4-1/2	Right	\$9.85
62444	9/32	2-1/4	4-1/2	Right	\$10.46
62463	1/4	2-1/4	6	-----	\$10.46
62464	5/16	2-1/4	6	-----	\$10.49

FOREST CITY

★★★Note: *Forest City* is out of business and we still have parts in stock. Meanwhile, we have integrated *ComSurge* for the future replacement for *Forest City's* parts listed below.★★★

HIGH-SPEED STEEL SINGLE-EDGE SPIRAL-FLUTE ROUTER BITS (No. X402S)



For cutting aluminum sheet, wall panels, plywood, chip board, insulation sheeting, plastics, and other synthetic materials. Reduces chipping and tear-out on veneers and laminated surfaces.

DOWN CUT-SPIRAL

Product Number	Cutting Diameter	Cutting Length	Shank Diameter	Price
62960	1/4"	3/4"	1/4"	\$11.01

UP CUT-SPIRAL

Product Number	Cutting Diameter	Cutting Length	Shank Diameter	Price
62953	3/8"	1-1/4"	1/2"	\$23.69

11-MILLIMETER SHANK POD BITS (No. X426)

For the multiple spindle carving machine. Manufactured from a special grade high-speed steel. Shanks are tempered for ease of adjustment.

Available in round bottom or square bottom.

Product Number	Twist	Size	Price
63704	Left	1/8"	\$11.66



HIGH-SPEED STEEL DOUBLE-EDGE SPIRAL-FLUTE ROUTER BITS (No. X400S)



UPCUT-SPIRAL
For slotting and mortising. Pulls chips up and out of the work. Reduces vibration.

Product Number	Cutting Diameter	Cutting Length	Shank Diameter	Price
62972	3/16"	5/8"	1/4"	\$10.82
62976	1/4"	1"	1/4"	\$10.12
62981	1/4"	3/4"	1/2"	\$19.27
62984	3/8"	1-1/4"	1/2"	\$24.26
62985	1/2"	1-1/4"	1/2"	\$20.79

Additional Specifications: All Shank Lengths: 2"

HIGH-SPEED STEEL DOUBLE-EDGE SPIRAL-FLUTE ROUTER BITS (No. X400S)



DOWN CUT-SPIRAL
Pushes chips down and away from material. Usually used with cutting through material where top surface is finished surface.

Product Number	Cutting Diameter	Cutting Length	Shank Diameter	Price
62992	1/4"	1"	1/4"	\$10.12

1/4-INCH SHANK CARVING ROUGHERS (No. X421)



These Super Wear Roughers are designed to give maximum life and ease of cutting stock to rough size on a multiple spindle carving machine.

Product Number	Twist	Size	Price
63713	Right	1"	\$24.65
63714	Left	1/2"	\$15.12
63716	Left	3/4"	\$17.48

4 FLUTE 813 SERIES COUNTERSINKS WITH TAPER POINT DRILL (No. 813)

\$11.03



Product Number	Screw Size	Drill Size
62890	10	3/16"

Used to Countersink & Countbore holes for screws in wood, plastic and non-ferrous metals. Drill bit is included with the countersink.

HIGH-SPEED STEEL STRAIGHT SINGLE-FLUTE ROUTER BITS (No. X402)



These "O" flute bits have high hook angle for free cutting. All are specially heat-treated to hold their precision ground cutting edge. All dimensions in inches.

Product Number	Cutting Diameter	Cutting Length	Shank Diameter	Shank Length	Price
62906	5/32"	1/2"	1/4"	1-1/4"	\$8.14



325 South Kimbrough
 Springfield, MO 65806
 www.ballewsaw.com

ORDER FORM Catalog #48

PLEASE FILL OUT ALL INFORMATION
 Orders will be processed quickly and efficiently.

Date _____ Business Name _____

Name of Person to Contact _____

Billing Address _____

City _____ State _____ Zip _____

Shipping Address _____

City _____ State _____ Zip _____

Phone () _____ Fax () _____

Have You ordered from Ballew Saw and Tool, Inc. before? Yes ___ No ___

METHOD OF PAYMENT (Please Check One)

- Cashiers Check / Money Order
- Mastercard
- Visa
- Discover
- American Express

C.O.D. (\$20.00 Additional Charge)

By indicating you want the order C.O.D., you agree to pay by Certified Check or Money Order ONLY. If you refuse delivery on a C.O.D. and want us to send it again, there will be another additional charge.

WE DO NOT ACCEPT PERSONAL OR COMPANY CHECKS, UNLESS IT IS FOR A PRE-PAYMENT AND YOU ALLOW TIME FOR THE CHECK TO CLEAR.

Credit Card # _____

Expiration Date _____ Security Code _____

Signature _____

PART #	DESCRIPTION (Include Bore Size)	QTY	RICE	TOTAL
Order Total				
MO Residents add 8.75% Tax				
Shipping Charge				
GRAND TOTAL				

**FREE SHIPPING ON UPS
 GROUND IF YOUR ORDER IS
 \$200 OR MORE**



325 South Kimbrough
 Springfield, MO 65806
 www.ballewsaw.com

ORDER FORM Catalog #48

PLEASE FILL OUT ALL INFORMATION
 Orders will be processed quickly and efficiently.

Date _____ Business Name _____

Name of Person to Contact _____

Billing Address _____

City _____ State _____ Zip _____

Shipping Address _____

City _____ State _____ Zip _____

Phone () _____ Fax () _____

Have You ordered from Ballew Saw and Tool, Inc. before? Yes ___ No ___

METHOD OF PAYMENT (Please Check One)

- Cashiers Check / Money Order
- Mastercard
- Visa
- Discover
- American Express

C.O.D. (\$20.00 Additional Charge)

By indicating you want the order C.O.D., you agree to pay by Certified Check or Money Order ONLY. If you refuse delivery on a C.O.D. and want us to send it again, there will be another additional charge.

WE DO NOT ACCEPT PERSONAL OR COMPANY CHECKS, UNLESS IT IS FOR A PRE-PAYMENT AND YOU ALLOW TIME FOR THE CHECK TO CLEAR.

Credit Card # _____

Expiration Date _____ Security Code _____

Signature _____

PART #	DESCRIPTION (Include Bore Size)	QTY	RICE	TOTAL
			Order Total	
			MO Residents add 8.75% Tax	
			Shipping Charge	
			GRAND TOTAL	

**FREE SHIPPING ON UPS
 GROUND IF YOUR ORDER IS
 \$200 OR MORE**



325 South Kimbrough
Springfield, MO 65806
www.ballewsaw.com

ORDER FORM Catalog #48

PLEASE FILL OUT ALL INFORMATION
Orders will be processed quickly and efficiently.

Date _____ Business Name _____

Name of Person to Contact _____

Billing Address _____

City _____ State _____ Zip _____

Shipping Address _____

City _____ State _____ Zip _____

Phone () _____ Fax () _____

Have You ordered from Ballew Saw and Tool, Inc. before? Yes ___ No ___

METHOD OF PAYMENT (Please Check One)

- Cashiers Check / Money Order
- Mastercard
- Visa
- Discover
- American Express

C.O.D. (\$20.00 Additional Charge)

By indicating you want the order C.O.D., you agree to pay by Certified Check or Money Order ONLY. If you refuse delivery on a C.O.D. and want us to send it again, there will be another additional charge.

WE DO NOT ACCEPT PERSONAL OR COMPANY CHECKS, UNLESS IT IS FOR A PRE-PAYMENT AND YOU ALLOW TIME FOR THE CHECK TO CLEAR.

Credit Card # _____

Expiration Date _____ Security Code _____

Signature _____

PART #	DESCRIPTION (Include Bore Size)	QTY	PRICE	TOTAL
Order Total				
MO Residents add 8.75% Tax				
Shipping Charge				
GRAND TOTAL				

**FREE SHIPPING ON UPS
GROUND IF YOUR ORDER IS
\$200 OR MORE**

ATTENTION

WE BOUGHT ALL OF THE 3/4" BORE "T"-ALLOY SHAPER CUTTERS FROM FREEBORN WHEN THEY DISCONTINUED PRODUCTION OF THE 3/4" BORE. BELOW ARE THE CUTTERS THAT WE HAVE LEFT, QUANTITIES, AND PRICING.

PART#	QTY	PRICE
MT-50-015	3	\$ 278.50
MT-50-015-EE	2	\$ 334.20
MT-50-025	1	\$ 278.50
MT-50-035	3	\$ 278.50
MT-50-035-EE	1	\$ 334.20
MT-50-040-EE	1	\$ 334.20
MT-50-045-EE	1	\$ 334.20
MT-50-050-EE	1	\$ 334.20
MT-50-060	5	\$ 278.50
MT-50-070	4	\$ 278.50
MT-50-070EE	1	\$ 334.20
MT-50-145	3	\$ 293.00
MT-50-145-EE	1	\$ 351.60
MT-50-310	3	\$ 317.50
MT-50-320	5	\$ 317.50
MT-50-340	3	\$ 317.50
MT-50-401	1	\$ 172.73
MT-50-401EE	2	\$ 207.27
MT-502-403	4	\$ 172.73
MT-50-403EE	2	\$ 207.27
MT-50-500-EE	1	\$ 274.20
MT-50-501	35	\$ 103.50
MT-50-502	38	\$ 103.50
MT-50-502-EE	4	\$ 124.20
MT-50-503	10	\$ 103.50
MT-50-503-EE	3	\$ 124.20
MT-50-601	17	\$ 103.50
MT-50-601-EE	3	\$ 124.20
MT-50-602	16	\$ 103.50
MT-50-602-EE	3	\$ 124.20
MT-50-604	12	\$ 103.50
MT-50-605	8	\$ 103.50
MT-50-607	10	\$ 103.50

PART#	QTY	PRICE
MT-50-608	8	\$ 103.50
MT-50-700	2	\$ 115.50
MT-50-701	3	\$ 91.87
MT-51-010	2	\$ 506.00
MT-51-011	3	\$ 506.00
MT-51-020	1	\$ 506.00
MT-51-030	5	\$ 506.00
MT-51-040	11	\$ 506.00
MT-51-041	8	\$ 506.00
MT-51-050	6	\$ 506.00
MT-51-060	7	\$ 506.00
MT-51-070	6	\$ 506.00
MT-51-080	3	\$ 506.00
MT-51-500	11	\$ 400.00
MT-51-903	7	\$ 103.50
MT-52-010	19	\$ 162.00
MT-52-020	12	\$ 162.00
MT-54-001	1	\$ 142.00
MT-54-002	4	\$ 142.00
MT-54-003	2	\$ 142.00
MT-54-004	3	\$ 142.00
MT-54-006	4	\$ 142.00
MT-54-007	9	\$ 142.00
MT-54-008	2	\$ 142.00
MT-54-009	7	\$ 142.00
MT-54-010	3	\$ 142.00
MT-54-011	4	\$ 142.00
MT-54-012	4	\$ 142.00
MT-54-013	4	\$ 142.00
MT-55-006	5	\$ 142.00
MT-55-008	4	\$ 142.00
MT-55-009	2	\$ 142.00
MT-55-010	3	\$ 142.00

PART#	QTY	PRICE
MT-55-011	5	\$ 142.00
MT-55-012	4	\$ 142.00
MT-55-013	4	\$ 142.00
MT-56-001	7	\$ 104.00
MT-56-002	4	\$ 104.00
MT-56-100	4	\$ 63.00
MT-57-001	4	\$ 112.00
MT-57-002	6	\$ 112.00
MT-57-003	4	\$ 112.00
MT-57-004	4	\$ 112.00
MT-57-005	2	\$ 112.00
MT-57-006	5	\$ 112.00
MT--57-007	4	\$ 112.00
MT-57-008	6	\$ 112.00
MT-57-009	4	\$ 112.00
MT-57-010	4	\$ 112.00
MT-57-011	6	\$ 112.00
MT-57-012	4	\$ 112.00
MT-57-013	6	\$ 112.00
MT-57-014	6	\$ 112.00
MT-57-015	5	\$ 112.00
MT-57-016	4	\$ 112.00
MT-57-017	4	\$ 112.00
MT-57-018	4	\$ 112.00
MT-57-019	3	\$ 112.00
MT-57-020	5	\$ 112.00
MT-57-021	7	\$ 112.00
MT-57-022	1	\$ 112.00
MT-57-023	5	\$ 112.00
MT-57-024	4	\$ 112.00
MT-57-025	7	\$ 91.00
MT-57-026	6	\$ 91.00

ATTENTION

WE BOUGHT ALL OF THE 3/4" BORE "T"-ALLOY SHAPER CUTTERS FROM FREEBORN WHEN THEY DISCONTINUED PRODUCTION OF THE 3/4" BORE. BELOW ARE THE CUTTERS THAT WE HAVE LEFT, QUANTITIES, AND PRICING.

<u>PART#</u>	<u>QTY</u>	<u>PRICE</u>	<u>PART#</u>	<u>QTY</u>	<u>PRICE</u>	<u>PART#</u>	<u>QTY</u>	<u>PRICE</u>
MT-57-027	4	\$ 98.50	MT-57-184	2	\$ 88.50	MT-64-003	4	\$ 83.50
MT-57-029	5	\$ 112.00	MT-57-185	3	\$ 88.50	MT-64-004	3	\$ 92.00
MT-57-030	4	\$ 91.00	MT-58-001	4	\$ 152.50	MT-64-006	4	\$ 128.00
MT-57-031	6	\$ 91.00	MT-59-010	3	\$ 294.50	MT-64-008	4	\$ 152.00
MT-57-040	3	\$ 78.00	MT-59-020	2	\$ 310.50	MT-64-009	4	\$ 159.00
MT-57-042	3	\$ 73.50	MT-59-030	7	\$ 294.50	MT-64-010	5	\$ 180.50
MT-57-043	4	\$ 91.50	MT-59-040	4	\$ 294.55	MT-65-002	4	\$ 72.00
MT-57-102	3	\$ 112.00	MT-60-002	6	\$ 71.00	MT-65-003	6	\$ 81.00
MT-57-103	2	\$ 112.00	MT-60-006	2	\$ 101.50	MT-65-004R	11	\$ 86.00
MT-57-104	4	\$ 112.00	MT-60-008	6	\$ 119.00	MT-65-005	4	\$ 92.00
MT-57-105	6	\$ 112.00	MT-60-012	5	\$ 144.00	MT-65-006	2	\$ 106.00
MT-57-106	5	\$ 112.00	MT-61-001	4	\$ 150.00	MT-65-006R	5	\$ 106.00
MT-57-107	3	\$ 112.00	MT-61-002	4	\$ 150.00	MT-65-008	4	\$ 106.00
MT-57-109	5	\$ 112.00	MT-61-003	5	\$ 150.00	MT-65-006R	5	\$ 106.00
MT-57-110	5	\$ 112.00	MT-62-002	6	\$ 57.50	MT-65-008	5	\$ 106.00
MT-57-111	6	\$ 112.00	MT-62-004	5	\$ 52.00	MT-65-010	3	\$ 138.00
MT-57-112	2	\$ 112.00	MT-62-005	6	\$ 55.00	MT-65-012	4	\$ 149.00
MT-57-113	7	\$ 112.00	MT-62-006	3	\$ 57.50	MT-66-001	4	\$ 209.00
MT-57-151	6	\$ 112.00	MT-62-007	5	\$ 60.50	MT-67-010	3	\$ 256.00
MT-57-152	8	\$ 112.00	MT-62-008	2	\$ 63.50	MT-68-020	5	\$ 189.50
MT-57-153	7	\$ 112.00	MT-62-010	9	\$ 66.50	MT-69-001	3	\$ 81.00
MT-57-154	6	\$ 112.00	MT-62-012	2	\$ 69.00	MT-71-006	5	\$ 78.00
MT-57-155	5	\$ 112.00	MT-62-014	8	\$ 72.00	MT-71-008	5	\$ 84.00
MT-57-156	3	\$ 112.00	MT-62-016	6	\$ 75.00	MT-71-012	4	\$ 100.50
MT-57-157	5	\$ 112.00	MT-62-020	6	\$ 81.00	MT-71-016	4	\$ 106.00
MT-57-158	6	\$ 112.00	MT-62-024	6	\$ 89.00	MT-71-020	3	\$ 120.50
MT-57-159	4	\$ 112.00	MT-62-028	5	\$ 100.50	MT-71-024	3	\$ 129.50
MT-57-160	4	\$ 112.00	MT-62-032	2	\$ 109.00	MT-72-002	1	\$ 257.50
MT-57-161	5	\$ 112.00	MT-63-002	5	\$ 63.50	MT-72-004	2	\$ 272.00
MT-57-162	4	\$ 112.00	MT-63-003	6	\$ 69.00	MT-73-002	3	\$ 103.50
MT-57-163	3	\$ 112.00	MT-63-004	4	\$ 78.00	MT-73-004	2	\$ 115.00
MT-57-181	7	\$ 88.50	MT-63-006	6	\$ 86.00	MT-73-006	3	\$ 128.00
MT-57-182	3	\$ 88.50	MT-63-008	6	\$ 109.00	MT-73-008	3	\$ 142.50
MT-57-183	6	\$ 88.50	MT-64-002	5	\$ 78.00			

FREEBORN

INSERT TOOLING

New 3 piece insert Cope and Pattern sets to allow easy fit adjustment.



\$675.00 Per Set with 1 set of inserts

- A two piece cope head with shims allow you to adjust your fit
- Common minor diameters and vertical profile centering eliminate the need to adjust the spindle height or fence position when switching from cope to pattern cuts
- Heads will accept both square and eased edges
- For 3/4" to 7/8" material
- 4-1/2" outside diameter, 3-1/2" minor diameter
- Use Bearing AP-90-058 (\$52)
- 4" diameter for Unique 250/265 available by special order
- 5.5mm x 1/2" tongue available by special order
- 1-1/4" bore
- Tips available in Carbide and T-Alloy
- Comes with shims for cope side

These 3 Profiles MUST Have Dedicated Heads.

Carbide Tip Sets \$190.00 For 3 Heads T-Alloy Tip Sets \$225.00 For 3 Heads

Dedicated Profile Insert Cutters (3/4" to 7/8")

		Part # I-10-010	Cope Top Tip # I (C/T)-000-CTS	Cope Bottom Tip # I (C/T)-010-CBS	Pattern Tip # I (C/T)-010-PS
		\$717.19	Carbide = \$50.00 T-Alloy = \$60.00	Carbide = \$50.00 T-Alloy = \$60.00	Carbide = \$90.00 T-Alloy = \$105.00
		Part # I-10-010 EASED	Cope Top Tip # I (C/T)-000-CTES	Cope Bottom Tip # I (C/T)-010-CBES	Pattern Tip # I (C/T)-010 PES
		\$717.19	Carbide = \$50.00 T-Alloy = \$60.00	Carbide = \$50.00 T-Alloy = \$60.00	Carbide = \$90.00 T-Alloy = \$105.00
		Part # I-10-060	Cope Top Tip # I (C/T)-000-CTS	Cope Bottom Tip # I (C/T)-060-CBS	Pattern Tip # I (C/T)-060-PS
		\$717.19	Carbide = \$50.00 T-Alloy = \$60.00	Carbide = \$50.00 T-Alloy = \$60.00	Carbide = \$90.00 T-Alloy = \$105.00
		Part # I-10-060 EASED	Cope Top Tip # I (C/T)-000-CTES	Cope Bottom Tip # I (C/T)-060-CBES	Pattern Tip # I (C/T)-060-PES
		\$717.19	Carbide = \$50.00 T-Alloy = \$60.00	Carbide = \$50.00 T-Alloy = \$60.00	Carbide = \$90.00 T-Alloy = \$105.00
		Part # I-10-510	Cope Top Tip # I (C/T)-000-CTS	Cope Bottom Tip # I (C/T)-510-CBS	Pattern Tip # I (C/T)-510-PS
		\$717.19	Carbide = \$50.00 T-Alloy = \$60.00	Carbide = \$50.00 T-Alloy = \$60.00	Carbide = \$90.00 T-Alloy = \$105.00
		Part # I-10-510 EASED	Cope Top Tip # I (C/T)-000-CTES	Cope Bottom Tip # I (C/T)-510-CBES	Pattern Tip # I (C/T)-510-PES
		\$717.19	Carbide = \$50.00 T-Alloy = \$60.00	Carbide = \$50.00 T-Alloy = \$60.00	Carbide = \$90.00 T-Alloy = \$105.00

FREEBORN

Multi Profile Insert Cutters (3/4" to 7/8" material)

INSERT TOOLING

Carbide Tip Sets 3 Heads per profiles \$190.00 Per Set	T-Alloy Tip Sets 3 Heads per profile \$225.00 Per Set
--	---

New 3 piece insert Cope and Pattern sets allow easy fit adjustment. Cope head is two pieces and pattern head is one piece.

Use Bearing AP-90-058 (\$52)

\$725.00 Per Set Includes

Our multi profile head will accept any of the five profiles shown below. One Set of Tips

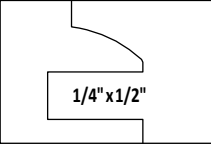
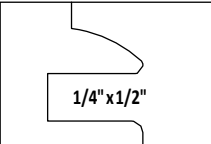
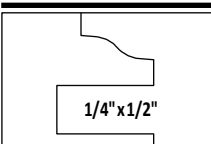
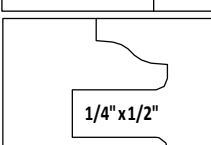
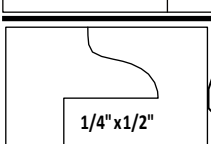
		Part #	Cope Top Tip #	Cope Bottom Tip #	Pattern Tip #
	I 10-011	I-10-011 \$770.31	I (C/T)-000-CTS Carbide = \$50.00 T-Alloy = \$60.00	I (C/T)-011-CBS Carbide = \$50.00 T-Alloy = \$60.00	I (C/T)-011-PS Carbide = \$90.00 T-Alloy = \$105.00
	I 10-011Eased	I-10-011 EASED \$770.31	Carbide = \$50.00 T-Alloy = \$60.00	Carbide = \$50.00 T-Alloy = \$60.00	Carbide = \$90.00 T-Alloy = \$105.00
	I 10-020	I-10-020 \$770.31	I (C/T)-000-CTS Carbide = \$50.00 T-Alloy = \$60.00	I (C/T)-020-CBS Carbide = \$50.00 T-Alloy = \$60.00	I (C/T)-020-PS Carbide = \$90.00 T-Alloy = \$105.00
	I 10-020Eased	I-10-020 EASED \$770.31	Carbide = \$50.00 T-Alloy = \$60.00	Carbide = \$50.00 T-Alloy = \$60.00	Carbide = \$90.00 T-Alloy = \$105.00
	I 10-030	I-10-030 \$770.31	I (C/T)-000-CTS Carbide = \$50.00 T-Alloy = \$60.00	I (C/T)-030-CBS Carbide = \$50.00 T-Alloy = \$60.00	I (C/T)-030-PS Carbide = \$90.00 T-Alloy = \$105.00
	I 10-030Eased	I-10-030 EASED \$770.31	Carbide = \$50.00 T-Alloy = \$60.00	Carbide = \$50.00 T-Alloy = \$60.00	Carbide = \$90.00 T-Alloy = \$105.00
	I 10-040	I-10-040 \$770.31	I (C/T)-000-CTS Carbide = \$50.00 T-Alloy = \$60.00	I (C/T)-040-CBS Carbide = \$50.00 T-Alloy = \$60.00	I (C/T)-040-PS Carbide = \$90.00 T-Alloy = \$105.00
	I 10-040Eased	I-10-040 EASED \$770.31	Carbide = \$50.00 T-Alloy = \$60.00	Carbide = \$50.00 T-Alloy = \$60.00	Carbide = \$90.00 T-Alloy = \$105.00
	I 10-050	I-10-050 \$770.31	I (C/T)-000-CTS Carbide = \$50.00 T-Alloy = \$60.00	I (C/T)-050-CBS Carbide = \$50.00 T-Alloy = \$60.00	I (C/T)-050-PS Carbide = \$90.00 T-Alloy = \$105.00
	I 10-050Eased	I-10-050 EASED \$770.31	Carbide = \$50.00 T-Alloy = \$60.00	Carbide = \$50.00 T-Alloy = \$60.00	Carbide = \$90.00 T-Alloy = \$105.00

**UNIQUE 250 & 265 INSERT TOOLING BY FREEBORN
SPECIAL DIAMETER TO WORK ON UNIQUE 250 & 265**

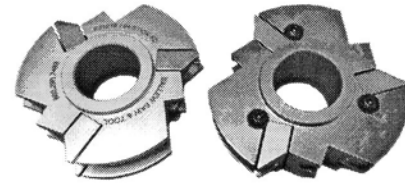

Our Insert Tooling Features the Following Benefits:

- Common Minor Diameters and Vertical Profile Centering.
With these two features you do not need to adjust the spindle height or fence position when switching from cope to pattern cuts.
- Easy indexing when replacing tips. Using a locating button on all sets, and a locking gib system for the cope and pattern sets and detail sets, changing tips is a quick and accurate process.
- Cope and Pattern bodies will accept both square and eased edge tips.
- **Cope and pattern:** Outside Diameter **4"**
Minor Diameter **3"**.

Dedicated Cope and Pattern INSERT Cutters For Unique 250 & 265
3/4" to 7/8" Material

PART	OUTSIDE DIAMETER	MINOR DIAMETER	PRICE
I-10-010 and 500	4	3	\$870.19
I-10-010 Eased and 500 Eased	4	3	\$870.19

Individual Carbide Tips
 • IC-10 THRU 500 = \$30/tip
Individual T-Alloy Tips
 • IT-10 THRU 500 = \$35/tip

These two heads are dedicated and different profiles cannot be installed. All other profiles by Freeborn are available as custom. See below for Freeborn multiple profile heads.

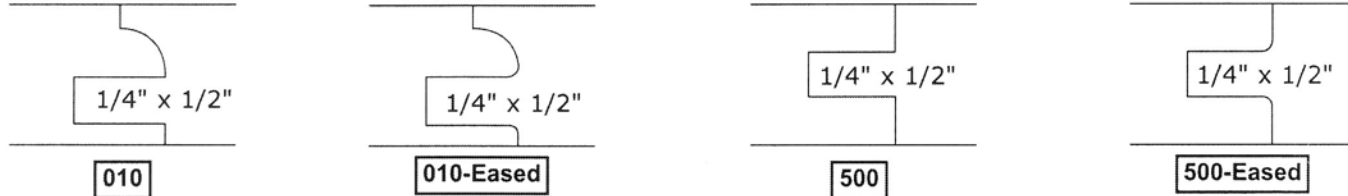

Multiple Profile INSERT Cope and Pattern Heads For Unique 250 & 265

Eased Edges available
 1-1/4" bore
 4" outside diameter
 Carbide and T-Alloy tips

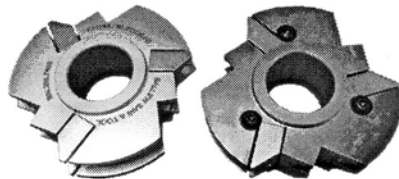

\$870.19 per set

with your first set of tips installed

Use Bearing AP-90-048 (\$52)

Accepts the following in-stock profiles:

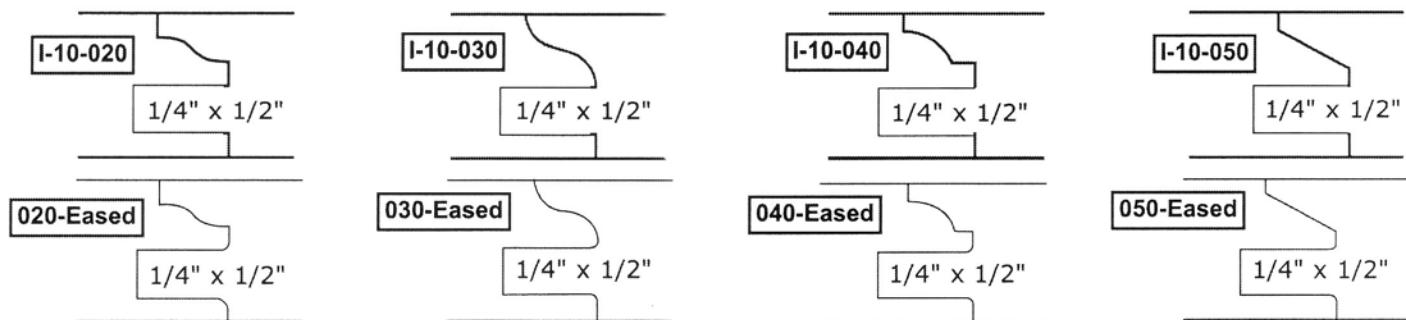

FREEBORN**Straight Cutter Insert Head****IC-22-016-SP**

- 4" Outer Diameter
- 1-1/4" Bore
- 30mm Tips - (1-1/8")
- 14x14mm Spur Bit

**\$212.50**

- IC-0300-050 Replacement Tips
(**Main**) Per Box of 10 = \$30.00/Box.

IC-0140-060 Replacement Tips
(**Spur**) Per Box of 10 = \$25.00/Box.

PLEASE NOTE: Spurs are required
for all cuts except trimming.

IC-22-032-SP

- 4" Outer Diameter
- 1-1/4" Bore
- 60mm Tips - (2-23/64)
- 14x14mm Spur Bit

**\$265.63**

- IC-0600-050 Replacement Tips (**Main**)
Per Box of 10 = \$45.00/Box.

- IC-0140-060 Replacement Tips (**Spur**)
Per Box of 10 = \$25.00/Box.

Using standard 30mm or 60mm carbide
inserts, this is an easy and inexpensive
way to perform trim or rabbet cuts.

Split Groover Insert Head**\$350.00****IC-22-ADJ**

2 piece expandable groover set using 12 x 12 main inserts.
Set your cut from 12.5mm - 24mm - (1/2" - 61/64") by using the
included spacer or shims. 6" outer diameter & 14 X 14 Spur Inserts.

- IC-0120-050 Replacement Tips (**Main**)
Per Box of 10 = \$25.00/Box.
- IC-0140-060 Replacement Tips (**Spur**)
Per Box of 10 = \$25.00/Box.

Spiral Insert Head Cutters**IS-22-032**

- 4" Outer Diameter
- 1-1/4" Bore
- 4 Wing
- 2" Height
- Aluminum Body
- IC-0150-060 Replacement Tips (15 X 15 X 2)
Per Box of 10 = \$28.50/Box.

**\$239.06****\$345.31****IS-22-064**

- 4" Outer Diameter
- 1-1/4" Bore
- 4 Wing
- 4" Height
- Aluminum Body

IC-0150-060 Replacement Tips (15 X 15 X 2)
Per Box of 10 = \$28.50/Box.

FREEBORN

Raised Panel Insert Cutters (3/4" material). Tips available in Carbide and T-Alloy

- Use Bearing AP-90-048 (\$55.25)
- 3wing •1-1/4"bore •6" diameter



("INSERT HEADS")

- All heads are dedicated to their own profile.
- Profiles are NOT interchangeable between heads.
- Each Profile needs its own separate head.
- 3-Wing- 1-1/4" Bore - 6" Diameter.
- Designed to work with 3" Bearing # AP-90-048.
- Designed to turn counter clockwise with wood fed face up, feeding right to left.
- Cutter head can be inverted & turned clockwise so wood can be fed left to right with wood above the cutter.

- The eight heads below are for 3/4" thick material & will create the profiles shown when using 3/4" thick material.
- If you want to use a back cutter with these heads you will need to use 7/8" material to get the full profile.
- Insert raised panel body= \$345.31 with your choice of Carbide or Alloy tips.

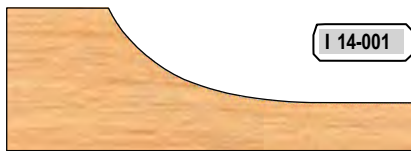

I 14-001

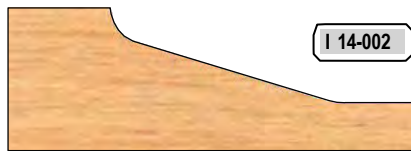

I 14-002

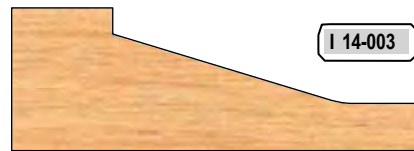

I 14-003

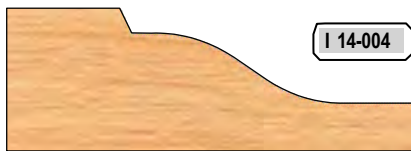

I 14-004



I 14-005



I 14-006

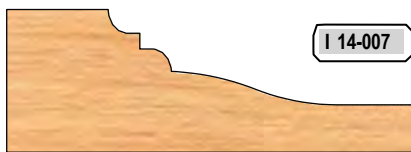

I 14-007



I 14-009

- IC-4-00? (Profile #) \$90.00 Per Set.
- IT-4-00? (Profile #) \$105.00 Per Set.

FREEBORN

Raised Panel Insert Cutters (5/8" material or 3/4" material using a backcutter)

• 3 wing • 1-1/4" bore • 6" diameter.

Designed to use 3" diameter bearing.

• Use Bearing AP-90-048 (\$55.25) Tips available in Carbide & Alloy

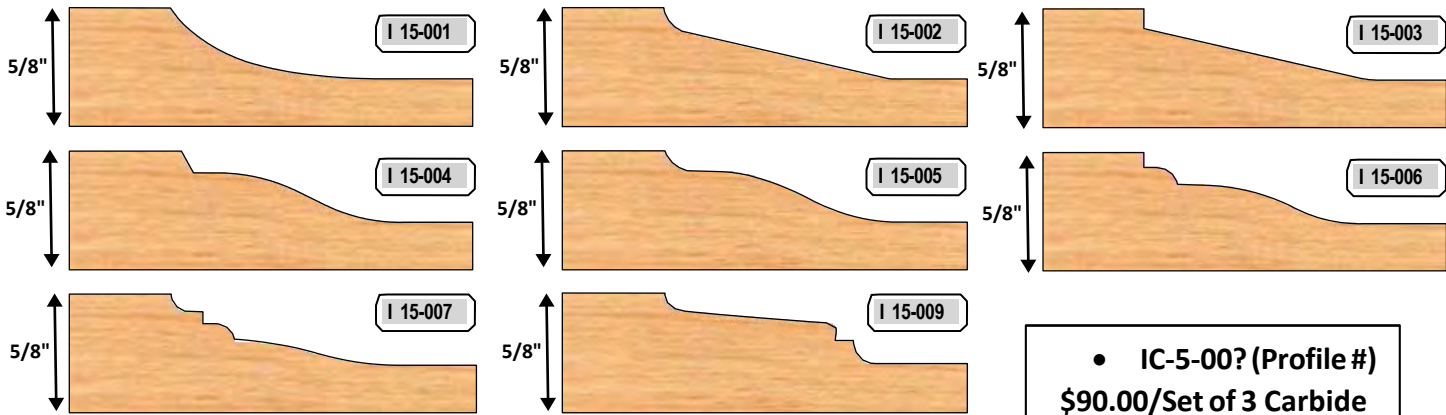

• INSERT RAISED PANEL HEAD (001-006) \$345.31
Comes with your choice of Carbide or Alloy tips.

• IC-5-00? (Profile #) \$90.00/Set of 3 Carbide
• IT-5-00? (Profile #) \$105.00/Set of 3 Alloy

• If you are using 5/8" material, use cutters shown above.
• If you are using 3/4" material & you want your panel to be flush with your 3/4" thick Rail & Style frame, then use the above cutters with a back cutter. (See below)

Insert Back&Trim Cutters • 3 wing • 1-1/4" bore • 4-3/4" diameter • Use Bearing AP-90-048 (\$55.25)

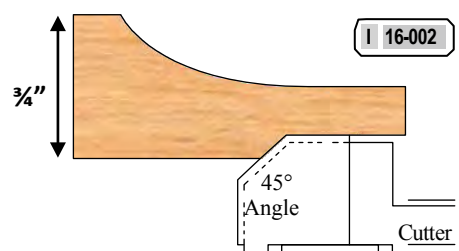
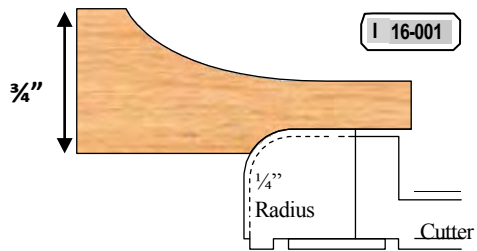

• Insert Back Cutter Body + Tips \$334.69
• IC-6-00? (Profile #) \$60.00/Set of 3 Carbide
• IT-6-00? (Profile #) \$75.00/Set of 3 Alloy

Insert Tongue Trimmer (CARBIDE ONLY)

Cutter Body + Tips \$239.06

I 16-100

CARBIDE ONLY
Tongue Trimmer \$212.50
Carbide Tips \$20.00/ Box of 10

FREEBORN

Door Edge Detail Insert Cutters

INDIVIDUAL CARBIDE TIPS

- IC-7-001 thru 113 = \$90.00/Set of 3 Tips

INDIVIDUAL T-ALLOY TIPS

- IT-7-001 thru 113 = \$105.00/ Set of 3 Tips

● THESE ARE DEDICATED HEADS AND MUST HAVE A DIFFERENT HEAD FOR EACH PROFILE.

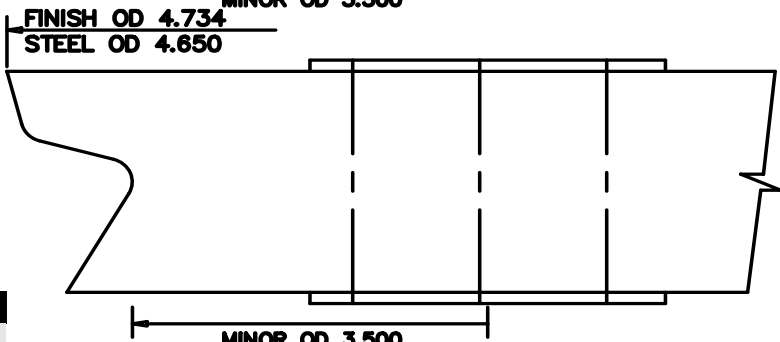
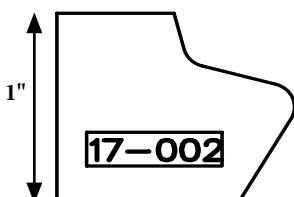
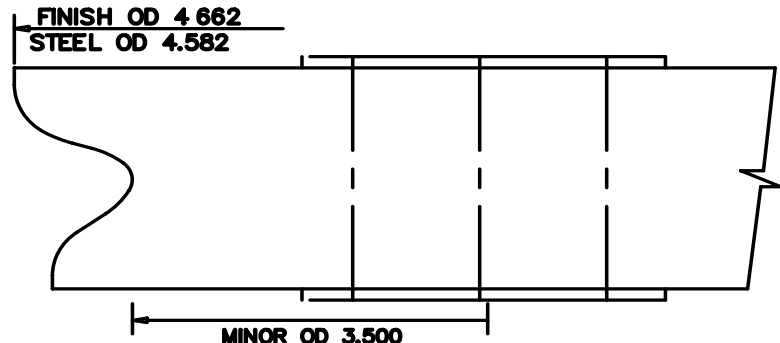
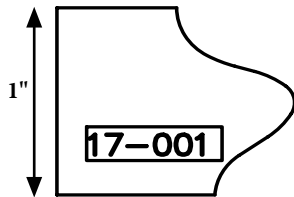

PART #	PRICE
I-17-001, 002, 101,110, 113	\$308.13

• Use Bearing AP-90-058 (\$55.25)

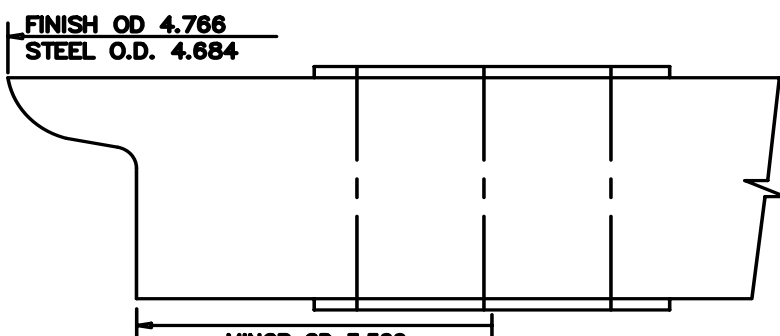
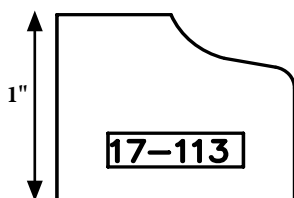
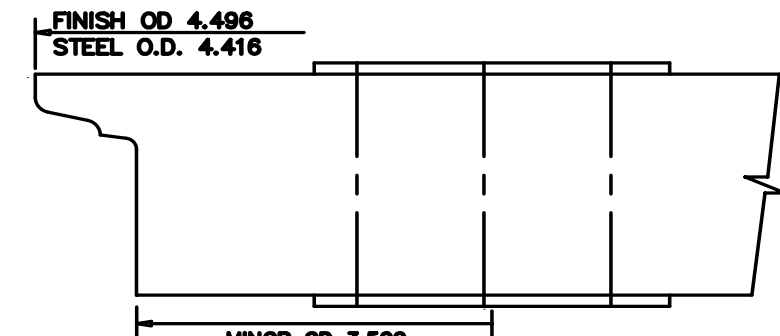
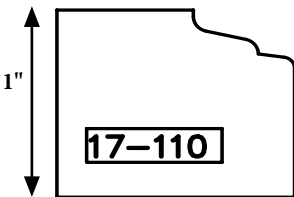
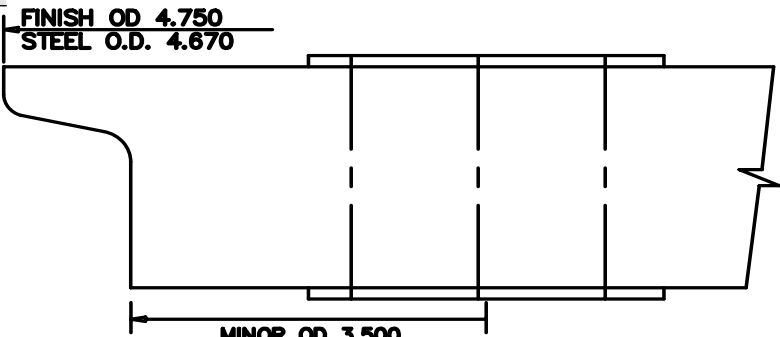
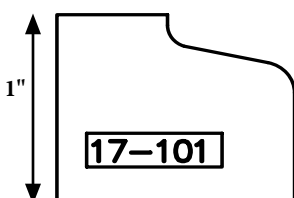

Insert Replacement Tips

COPE AND PATTERN						
SET #	Carbide Cope Top	Carbide Cope Bottom	Carbide Pattern	Alloy Cope Top	Alloy Cope Bottom	Alloy Pattern
I-10-010	IC-000-CTS	IC-010-CBS	IC-010-PS	IT-000-CTS	IT-010-CBS	IT-010-PS
I-10-010-E	IC-000-CTES	IC-010-CBES	IC-010-PES	IT-000-CTES	IT-010-CBES	IT-010-PES
I-10-011	IC-000-CTS	IC-011-CBS	IC-011-PS	IT-000-CTS	IT-011-CBS	IT-011-PS
I-10-011-E	IC-000-CTES	IC-011-CBES	IC-011-PES	IT-000-CTES	IT-011-CBES	IT-011-PES
I-10-020	IC-000-CTS	IC-020-CBS	IC-020-PS	IT-000-CTS	IT-020-CBS	IT-020-PS
I-10-020-E	IC-000-CTES	IC-020-CBES	IC-020-PES	IT-000-CTES	IT-020-CBES	IT-020-PES
I-10-030	IC-000-CTS	IC-030-CBS	IC-030-PS	IT-000-CTS	IT-030-CBS	IT-030-PS
I-10-030-E	IC-000-CTES	IC-030-CBES	IC-030-PES	IT-000-CTES	IT-030-CBES	IT-030-PES
I-10-040	IC-000-CTS	IC-040-CBS	IC-040-PS	IT-000-CTS	IT-040-CBS	IT-040-PS
I-10-040-E	IC-000-CTES	IC-040-CBES	IC-040-PES	IT-000-CTES	IT-040-CBES	IT-040-PES
I-10-050	IC-000-CTS	IC-050-CBS	IC-050-PS	IT-000-CTS	IT-050-CBS	IT-050-PS
I-10-050-E	IC-000-CTES	IC-050-CBES	IC-050-PES	IT-000-CTES	IT-050-CBES	IT-050-PES
I-10-060	IC-000-CTS	IC-060-CBS	IC-060-PS	IT-000-CTS	IT-060-CBS	IT-060-PS
I-10-060-E	IC-000-CTES	IC-060-CBES	IC-060-PES	IT-000-CTES	IT-060-CBES	IT-060-PES
I-10-500	IC-000-CTS	IC-500-CBS	IC-500-PS	IT-000-CTS	IT-500-CBS	IT-500-PS
I-10-500-E	IC-000-CTES	IC-500-CBES	IC-500-PES	IT-000-CTES	IT-500-CBES	IT-500-PES
I-10-510	IC-000-CTS	IC-510-CBS	IC-510-PS	IT-000-CTS	IT-510-CBS	IT-510-PS
I-10-510-E	IC-000-CTES	IC-510-CBES	IC-510-PES	IT-000-CTES	IT-510-CBES	IT-510-PES

RAISED PANEL					
SET #	CARBIDE	ALLOY	SET #	CARBIDE	ALLOY
I-14-001	IC-4-001-S	IT-4-001-S	I-15-001	IC-5-001-S	IT-5-001-S
I-14-002	IC-4-002-S	IT-4-002-S	I-15-002	IC-5-002-S	IT-5-002-S
I-14-003	IC-4-003-S	IT-4-003-S	I-15-003	IC-5-003-S	IT-5-003-S
I-14-004	IC-4-004-S	IT-4-004-S	I-15-004	IC-5-004-S	IT-5-004-S
I-14-005	IC-4-005-S	IT-4-005-S	I-15-005	IC-5-005-S	IT-5-005-S
I-14-006	IC-4-006-S	IT-4-006-S	I-15-006	IC-5-006-S	IT-5-006-S
I-14-007	IC-4-007-S	IT-4-007-S	I-15-007	IC-5-007-S	IT-5-007-S
I-14-009	IC-4-009-S	IT-4-009-S	I-15-009	IC-5-009-S	IT-5-009-S

BACK CUTTER			TRIM CUTTER	
SET #	CARBIDE	ALLOY	SET #	CARBIDE
I-16-001	IC-6-001-S	IT-6-001-S	I-16-100	IC-0140-060*
I-16-002	IC-6-002-S	IT-6-002-S		

DETAIL CUTTER		
SET #	CARBIDE	ALLOY
I-17-001	IC-7-001-S	IT-7-001-S
I-17-002	IC-7-002-S	IT-7-002-S
I-17-101	IC-7-101-S	IT-7-101-S
I-17-110	IC-7-110-S	IT-7-110-S
I-17-113	IC-7-113-S	IT-7-113-S

MISCELLANEOUS CUTTERS		
SET #	MAIN	SPUR
IC-22-016-SP	IC-0300-050*	IC-0140-060*
IS-22-032-SP	IC-0600-050*	IC-0140-060*
IC-22-ADJ	IC-0120-050*	IC-0140-060*
IC-22-032	IC-0150-060*	
IS-22-064	IC-0150-060*	



FREEBORN OFFERS "CUSTOM INSERT TOOLING"

	Carbide	Alloy
• Custom Insert COPE & PATTERN 2 Piece Heads are \$799.00		
• You Must Buy 3 Sets of Tips (18 tips).	\$720.00	\$810.00
• TOTAL Cost for Custom Insert COPE & PATTERN Sets.	\$1519.00	\$1609.00
<hr/>		
• Custom Insert RAISED PANEL Heads are \$425.00.		
• You Must Buy 3 Sets of Tips (9 tips).	\$360.00	\$405.00
• TOTAL Cost for Custom RAISED PANEL Insert Head & Insert Tips.	\$785.00	\$830.00
<hr/>		
• Custom Insert DOOR EDGE Detail Heads are \$425.00		
• You Must Buy 3 Sets of Tips (9 tips).	\$360.00	\$405.00
• TOTAL Cost for Custom DOOR EDGE Head & Inserts.	\$785.00	\$830.00

- **UNIQUE 250/265 INSERT TOOLING for 4" Cope & Pattern Heads sells for \$799.00 (IF using the profiles from STANDARD Insert Tooling).**
- **7" Raised Panel Insert Tooling for UNIQUE 250/265 sells for \$425.00 (IF using the STANDARD Raised Panel Tips available).**
- **Custom Raised Panel Heads are available (See Above).**
- **Above prices are for "NORMAL TOOLING".**
- **Very large diameters, more than 3 wings, or anything out of the ordinary will need to be quoted.**
- **2 piece Cope Side Heads are available.....Call for a quote.**

FREEBORN

Cope & Pattern (6 Piece Cutter Sets)

BRAZED TOOLING

Not Insert Tooling.

These are brazed not insert.

Versatile and easy-to-use. These 6 piece cutter sets are designed to perform the 3 functions shown. Our standard sets cut 1/4" wide x 3/8" deep tongue and groove.

Our common minor diameter requires NO fence adjustment when changing from cope to to pattern cuts (3/8" tongue only).

Counterclockwise rotation with wood fed face down.

For opposite rotation add 20% & allow 2 weeks for delivery.

MINI-PRO cutters • 3 wing • 2-15/16" diameter • 3/4" bore • Runs with a 2-3/16" diameter rub bearing (AM-90-035) \$48.45	PRO-LINE cutters • 3 wing • 4" diameter • 1-1/4" bore • Runs with a 3-1/4" diameter rub bearing (AP-90-052) \$55.25
--	---

Part #	Price	Eased Edge Price
MC-50-010 Thru 050	\$430.10	\$515.91
PC-10-010 Thru 050	\$506.60	\$606.90
MT-50-010 Thru 050 (Limited Supply)	\$295.90	\$355.09
PT-10-010 Thru 050	\$556.75	\$668.16



Wood samples shown actual size.

Cope & Pattern 3/4" to 1-1/8" material	Glass Panel 3/4" to 1" material	Tongue & Groove 3/4" material
010 1/4" x 3/8"		
015 1/4" x 3/8"		
020 1/4" x 3/8"		
025 1/4" x 3/8"		
030 1/4" x 3/8"		
035 1/4" x 3/8"		
040 1/4" x 3/8"		
045 1/4" x 3/8"		
050 1/4" x 3/8"		

FREEBORN

Cope & Pattern (6 Piece Cutter Sets)

Cope & Pattern
3/4" to 1-1/8" material

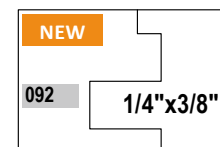
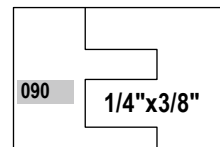
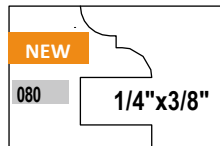
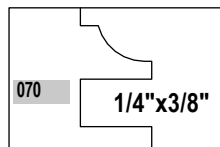
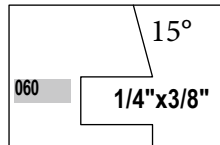
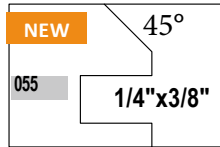

Glass Panel
3/4" to 1" material

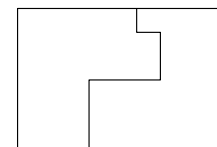
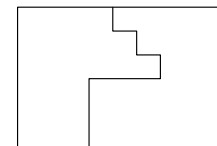
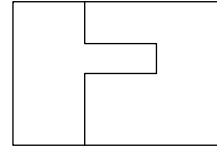
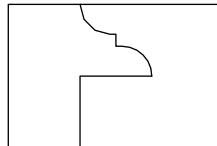
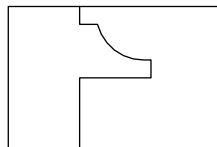
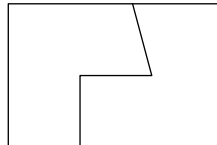
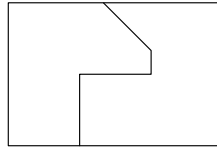

BRAZED TOOLING

Tongue & Groove
3/4" material

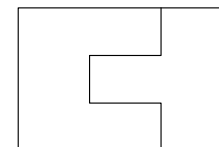
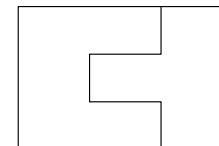
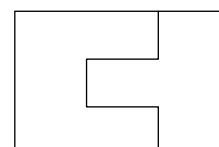
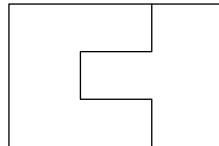
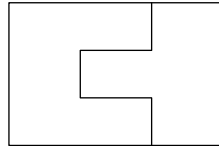
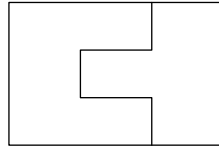
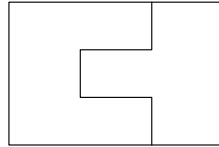

Part #	Price	Eased Edge Price
MC-50-055 Thru 090	\$430.10	\$515.91
PC-10-010 Thru 092	\$506.60	\$606.90
MT-50-010 Thru 092 (Limited Supply)	\$295.90	\$355.09
PT-10-010 Thru 092	\$556.75	\$668.10



Wood Samples Shown Actual Size

Part #	Price	Eased Edge Price
MC-50-500	\$352.75	\$423.30
PC-10-500	\$415.65	\$498.75
MT-50-500 (Limited Supply)	N/A	\$274.20
PT-10-500	\$457.30	\$548.76

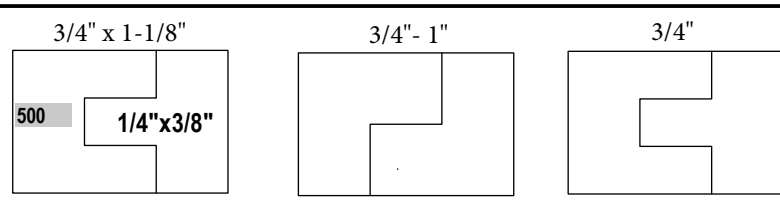

Part#	Price	Eased Edge Price
MC-50-145	\$452.20	\$542.64
PC-10-145	\$531.20	\$638.52
MT-50-145 (Limited Supply)	\$311.31	\$373.58
PT-10-145	\$585.65	\$702.78

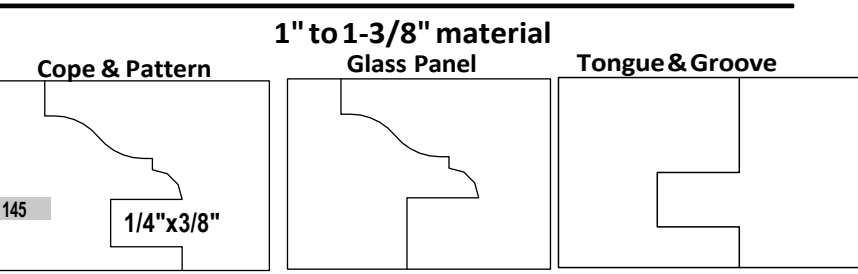

FREEBORN

Double Sided Cope & Pattern (6 Piece Cutter Sets)

Standard sets cut 1/4" wide x 3/8" deep tongue and groove.

Part #	Price	Eased Edge Price
MC-50-310,320,340	\$491.30	\$589.56
PC-10-310,320,340	\$577.15	\$692.58
MT-50-310,320,340 (Limited Supply)	\$337.35	N/A
PT-10-310,320,340	\$634.95	\$761.94

\$48.45 1" to 1-1/8" material

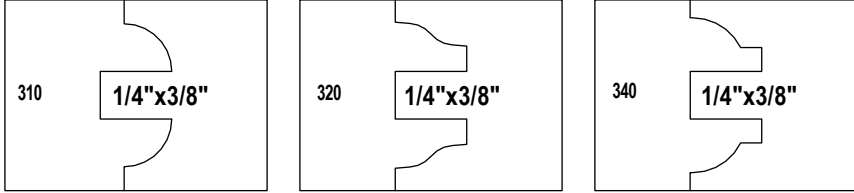

Wood samples shown actual size.

MINI-PRO cutters

- 3wing • 2-15/16" diameter
- 3/4" bore • Run with a 2-3/16" diameter rubber bearing (AM-90-035)

PRO-LINE cutters

- 3wing • 4" diameter
- 1-1/4" bore • Run with a 3-1/4" diameter rubber bearing (AP-90-052)

\$55.25

Center Groover Sets (2 Piece Sets)

At time of purchase, you may substitute the following tongue & groove cutters for the standard tongue & groove cutters in your cope & pattern set, at no additional charge. If you choose an optional center groover set other than 3/8" depth, you will be unable to do the tongue & groove option.

Available on all M-50 and P-10 series cope & patterns.

For options other than 3/8" depth, diameters will no longer be the same, requiring fence adjustments between cuts.

Part #	Price	Eased Edge Price
MC-50-501 Thru 610	\$106.25	\$127.50
PC-10-501 Thru 610	\$127.50	\$153.00
MT-50-501 Thru 610 (Limited Supply)	\$109.97	\$131.96
PT-10-501 Thru 610	\$140.25	\$168.30

Part #	Eased Edge Price
MC-50-700 thru 702	\$214.20
PC-10-700 thru 702	\$249.90
MT-50-700 thru 702 (Limited Supply)	\$122.72
PT-10-700 thru 702	\$274.38

Center Groovers Only - Profile cutters not included

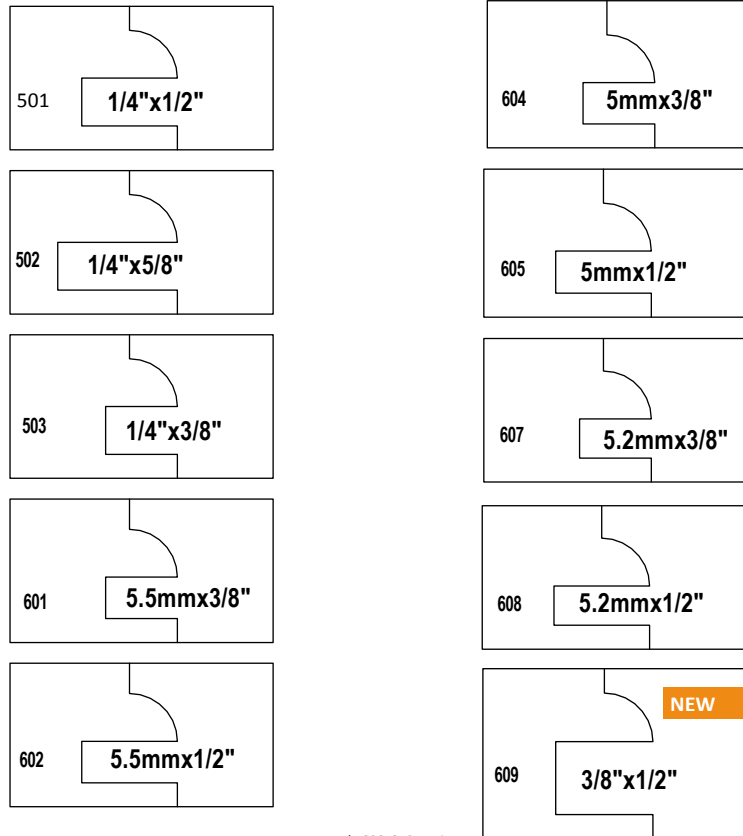

Both 609-610 options are for 7/8" mat. min.

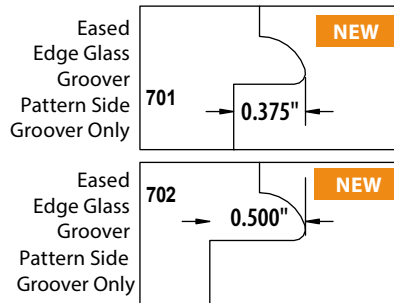

Glass Option (for rubber extrusion)

FREEBORN
Optional Eased Edge Sets **Cope & Pattern Stacking Instructions**

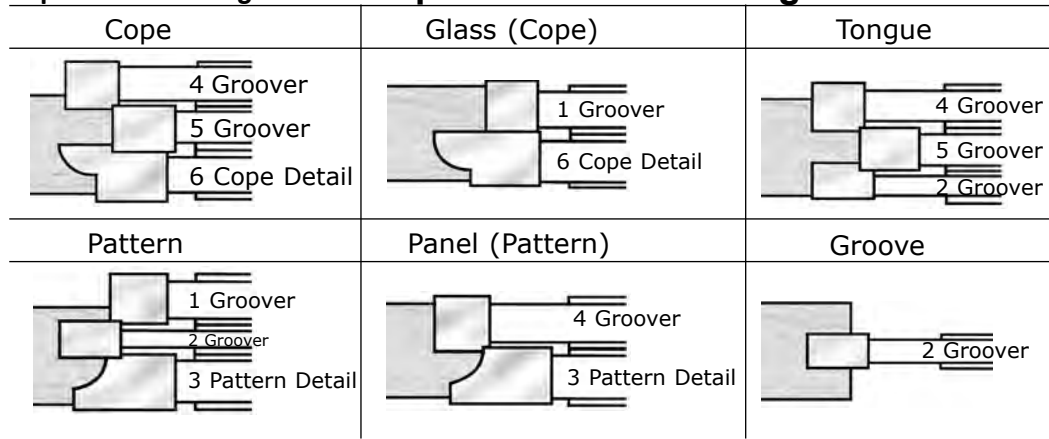

Eased edges are available on all 10 and 50 series cope and patterns. However, you cannot do glass panel or tongue and groove without optional groovers.

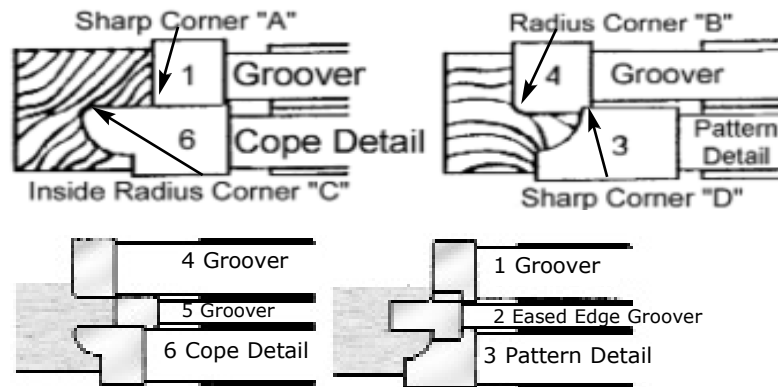

For desired results, use the following guide to set up each operation. **REMEMBER:** Always stagger cutters when stacking. Except when using an eased edge set.

Each function of the 6 piece cope and pattern set requires a different cutter configuration.

REMEMBER: Always stagger cutters when stacking. Never stack wing-to-wing or you will bend the center groover.

If you use an Eased Edge set to do glass panels, you'll have this problem if you do not have an extra cutter.

Optional Eased Edge Cutter

for Glass Panel Applications

PART	PRICE
MC-50-701	\$178.50
MT-50-701 (Limited Supply)	\$97.61
PC-10-701	\$208.25
PT-10-701	\$228.65

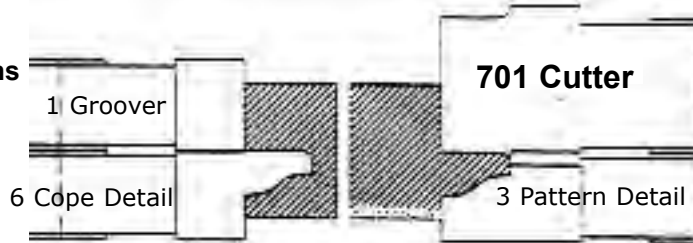

Glass Option Cutters for Rubber Extrusion

PART	PRICE	EASED EDGE PRICE
MC-50-700	\$178.50	\$201.60
PC-10-700	\$508.25	\$235.2
MT-50-700	\$115.50 (Limited Supply)	N/A
PT-10-700	\$228.65	\$258.24

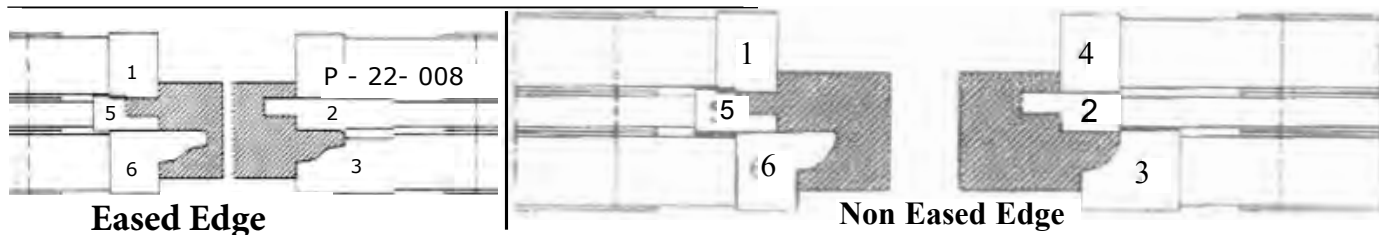
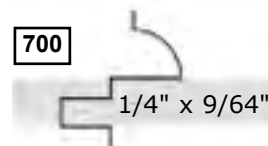

FREEBORN

Split Groover Sets

These 4 piece split groover sets are used in the 10 and 50 series cope and pattern sets to allow you to cut between 3/16" and 5/16" with shims .

NOTE: Provides adjustment for spindle alignment issues. If bought with purchase of a new 6 piece set, exchange price is \$165.00 ABOVE the price of the set.

3/8" Depth

1/2" Depth

Part #	Price	Eased Edge Price	Part #	Price	Eased Edge Price
MC-50-403	\$266.90	\$320.28	MC-50-401	\$366.90	\$320.28
PC-10-403	\$313.65	\$376.38	PC-10-401	\$313.65	\$376.38
MT-50--403 (Limited Supply)	\$172.73	\$207.27	MT-50-401 (Limited Supply)	\$183.53	\$220.22
PT-10-403	\$344.25	\$413.10	PT-10-401	\$344.25	\$413.10



Cope & Pattern Sets by Freeborn

PC-10-010A

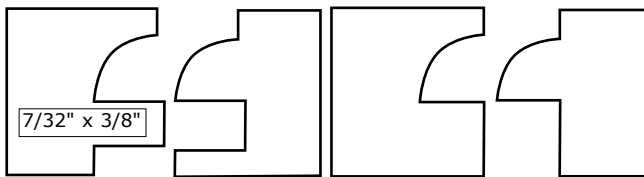

Not stocked -
Allow 7-10 days
to manufacture.

PC-10-040A

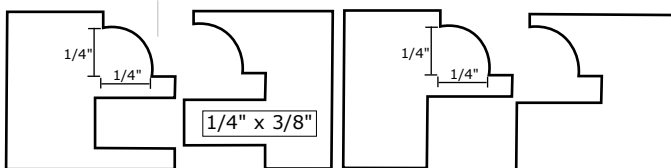

Tooling available for:
*Unique
*Weaver
*RBI
*Logosol
*PMK
*Lancaster Pro-cut

PC-10-060A

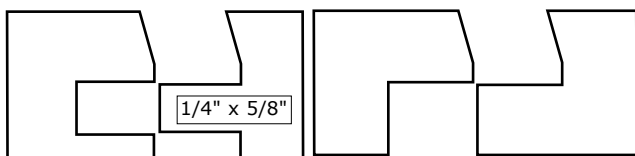

PART	EASED EDGE	
	PRICE	PRICE
MC-50-040A & 060A	\$546.70	\$656.06
PC-10-040a & 060A	\$643.68	\$772.42
PT-10-040A & 060A	\$707.40	\$848.88

Freeborn Tooling for Lancaster Pro-Cut Machine - 3/4" Bore



\$483.86

FREEBORN

Cope & Pattern (6 Piece Cutter Sets)

1/2" DEPTH OF PATTERN

New Deeper Profile Sets

Versatile and easy-to-use. These 6 piece cutter sets are designed to perform the 3 functions shown. Our standard sets cut 1/4" wide by 1/2" deep tongue and groove.

Our common minor diameter requires NO fence adjustment when changing from cope to pattern cuts. (1/2" tongue only)

Counterclockwise rotation with wood fed face down.

For opposite rotation add 20%.
Wood samples shown actual size.

Tongue Size is 1/4 X 1/2 only.
Different Size Tongue is Custom Groovers.



Part #	Price	Eased Edge Price
MC-50-211 Thru 250	\$466.65	\$559.98
PC-10-211 Thru 250	\$531.25	\$637.50
PT-10-211 Thru 250	\$582.25	\$698.70

MINI-PRO cutters

- 3 wing • 3.19" diameter
- 3/4" bore • Runswith a rub bearing (AM-90-035)

PRO-LINE cutters

- 3 wing • 4.25" diameter
- 1-1/4" bore • Runswith a rub bearing (AP-90-052)

3/4" to 1-1/8" material

Cope & Pattern
3/4" to 1-1/8" material

Glass Panel

3/4" to 1" material

Tongue & Groove
3/4" material

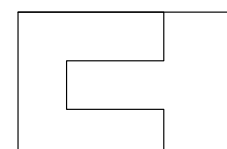
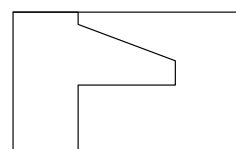
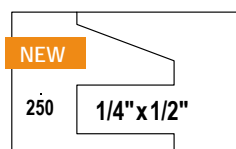
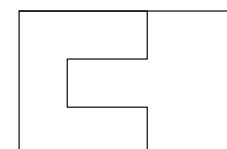
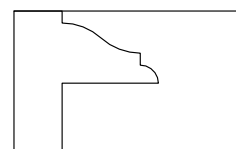
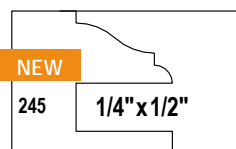
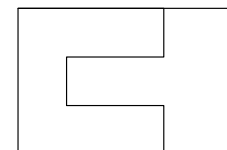
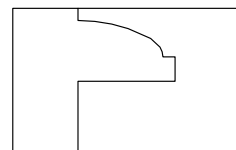
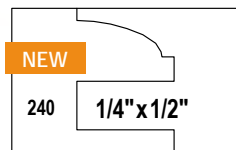
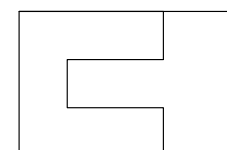
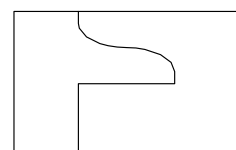
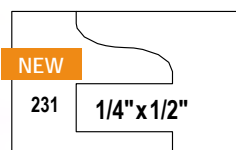
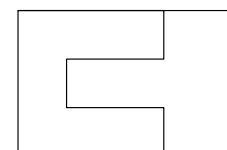
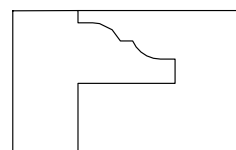
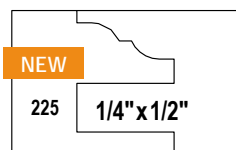
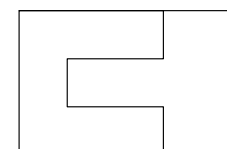
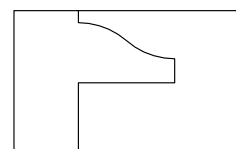
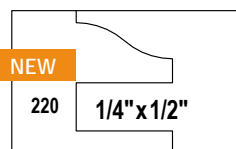
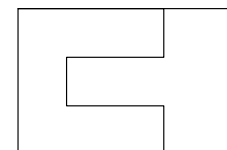
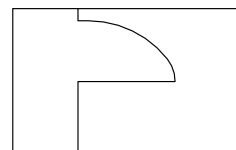
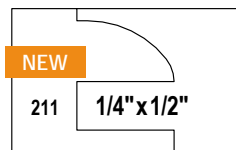

FREEBORN

Double Sided Cope & Pattern (8 Piece Cutter Sets)

Standard sets cut 1/4" x 5/8" or 1/2" x 5/8" deep tongue and groove. Mini-pro not to be used on 1/2" spindle. These 8 piece cutter sets are built to cut both 1-3/8" passage doors and 1-3/4" entry doors simply by changing the center cutters. A 2-piece glass panel groover set is also available to run with these sets.

PRICE	PART
\$782.00	MC-51-010 thru 050
\$537.63 (Limited Supply)	MT-51-010 thru 050
\$919.70	PC-11-010 thru 050
\$1011.50	PT-11-010 thru 050

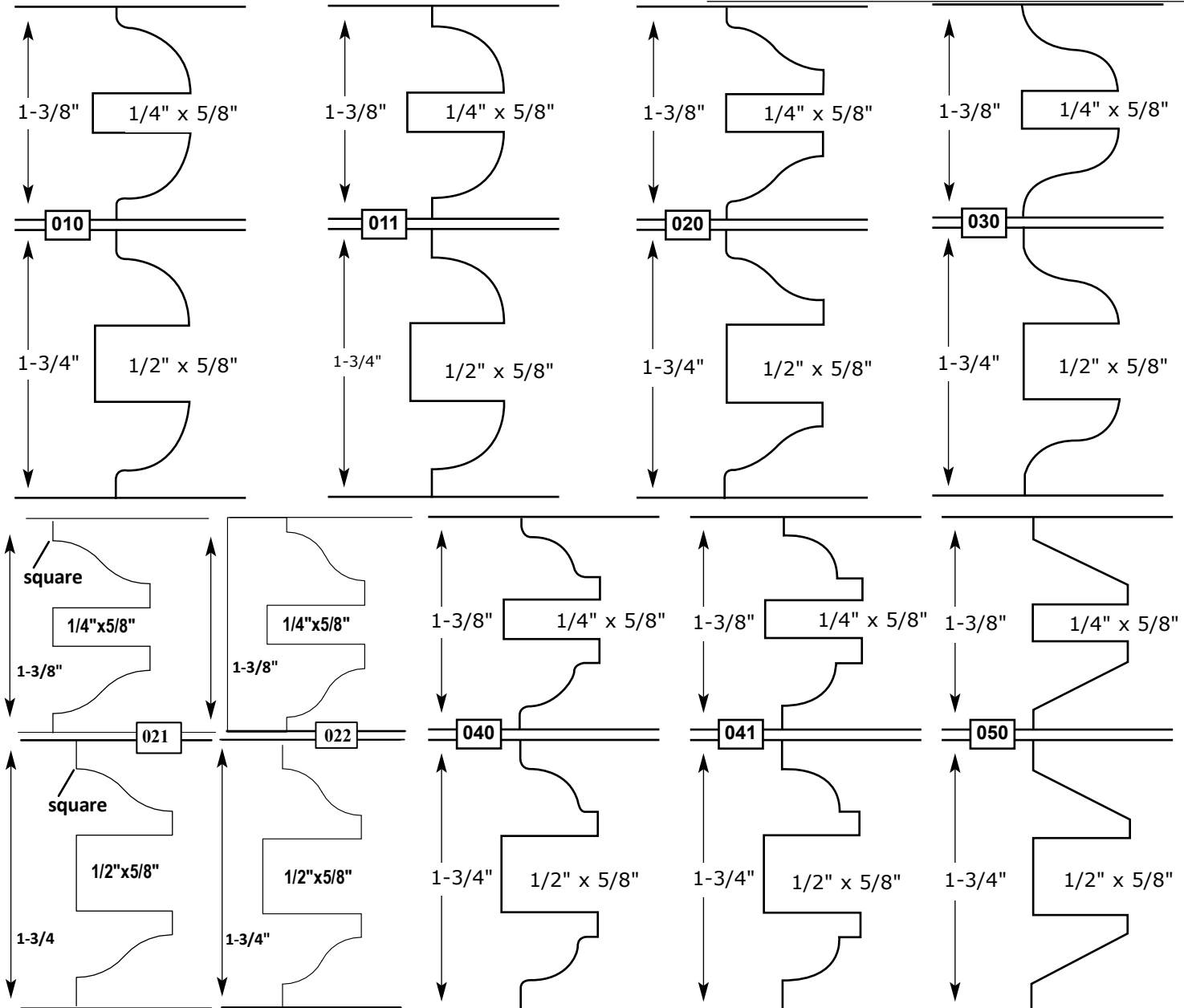

Mini-Pro Cutters Are 2-15/16 in Diameter, 3/4 Bore
Use a 1-11/16 Rub Bearing ([AM-90-027, \\$48.45](#))

Pro-Line Cutters Are 4" in Diameter, 1-1/4 Bore
Use a 2-3/4 Rub Bearing ([AM-90-044, \\$55.25](#))



Eased Edges are available for an additional 20%

FREEBORN

Double Sided Cope & Pattern (8 Piece Cutter Sets)

MC-51-060 thru 090	\$782.00
MT-51-060 thru 090 (Limited Supply)	\$537.63
PC-11-060 thru 090	\$919.70
PT-11-060 thru 090	\$1011.50

1-3/8" material

1-3/8" material

1-3/4" material

1/4"x5/8"

1/2"x5/8"

1/4"x5/8"

1/2"x5/8"

1/4"x5/8"

1/2"x5/8"

1/4"x5/8"

1/2"x5/8"

1/4"x5/8"

1/2"x5/8"

NOTE: All profiles shown may be made as a window sash set. Profiles shown as examples only.

MC-51-500	\$617.95
MT-51-500 (Limited Supply)	\$425.00
PC-11-500	\$726.75
PT-11-500	\$799.85

5/8" Deep Optional Center Groover Chart
Not Adjustable

	Mini Pro Set	Price	Pro Line Set	Price
1/4" Groovers Only	MC-51-904	\$106.25	PC-11-904	\$127.50
			PT-11-904	\$140.25
3/8" Groovers Only	MC-51-903	\$106.25	PC-11-903	\$127.50
			PT-11-903	\$140.25
1/2" Groovers Only	MC-51-905	\$106.25	PC-11-905	\$127.50
			PT-11-905	\$140.25

1/2" Deep Optional Center Groover Chart
Not Adjustable

	Mini Pro Set	Price	Pro Line Set	Price
1/4" x 1/2"	MC-51-906	\$106.25	PC-11-906	\$127.50
			PT-11-906	\$140.25
3/8" x 1/2"	MC-51-907	\$106.25	PC-11-907	\$127.50
			PT-11-907	\$140.25
1/2" x 1/2"	MC-51-908	\$106.25	PC-11-908	\$127.25
			PT-11-908	\$140.25

Optional Glass Panel Groovers (2 Piece Cutter Sets)

These Glass Panel sets consist of 2" groovers to allow a Total material height of 2-1/2" when run with the profile cutters from your Cope and Pattern set. Any of the Double Sided Cope and Pattern profiles can be made into dedicated Glass Panel sets upon request.

Part #	Price
MC-52-011 & 021	\$165.75
PC-12-011 & 021	\$191.25
PT-12-011 & 021	\$212.50

Runs with 010, 011, 022, 040, 041, 060 and 500.

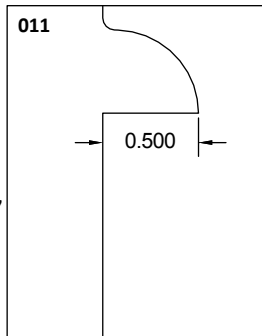

Profile shapes are for example only. Set consists of 2 groovers only.

Runs with 020, 021, 030, 050, 070, 080, 090 and 500.

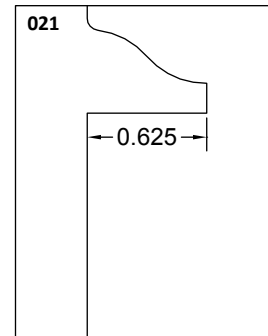

4Piece Glass Panel Sets to cut
 1-3/8" & 1-3/4" glass doors.
 Can be ordered face up or face down.
 1/2" Rabbet

FREEBORN

PART	PRICE
MC-51-010-GP thru 080GP	\$532.42
PC-11-010-GP thru 080-GP	\$667.46
PT-11-010-GP thru 080-GP	\$734.40

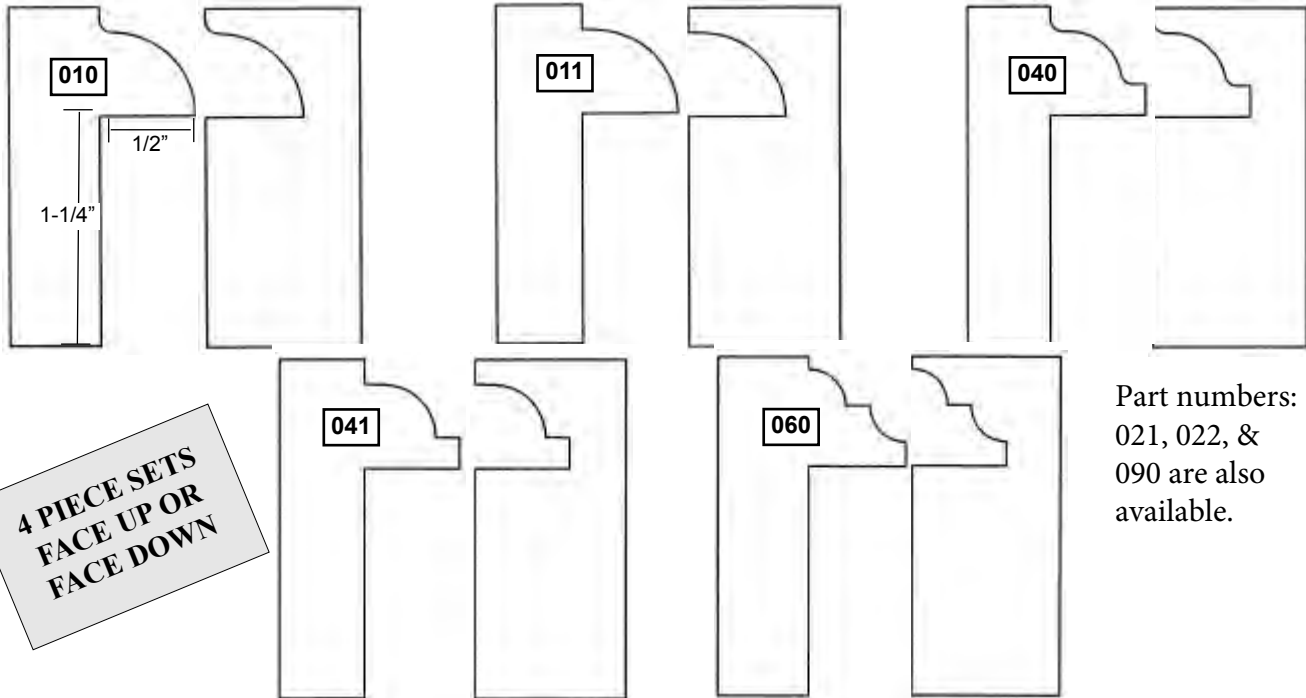

5/8" Rabbet

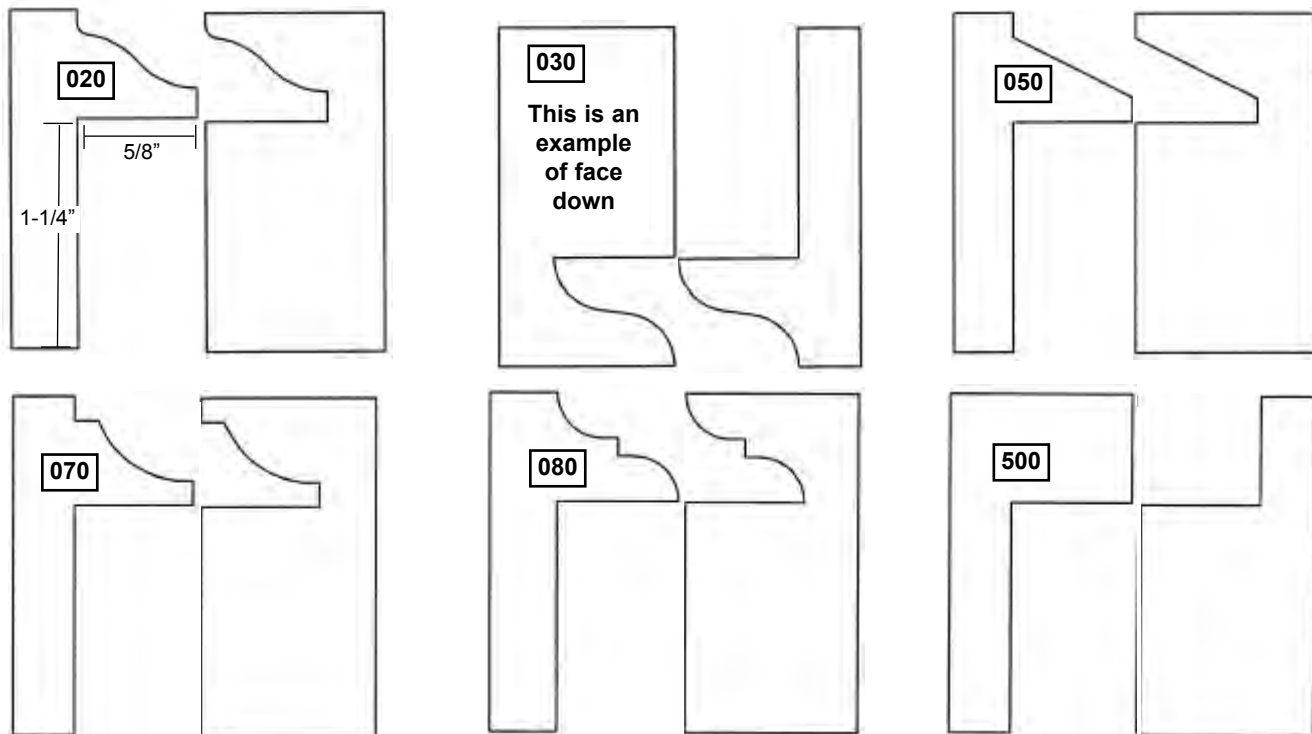

FREEBORN

Cutters (3/4" Material) Raised Panel Shaper

Our raised panel cutters are manufactured with 15° SHEAR to produce optimum cuts both with and across the grain.

Counterclockwise rotation with wood fed face up.
For opposite rotation add 20% to price.

Part #	Price
MC-55-001 Thru 017	\$220.15
PC-15-001 Thru 017	\$258.40
MT-54-001 Thru 013 (Limited Supply)	\$150.88
PT-15-001 Thru 017	\$284.75

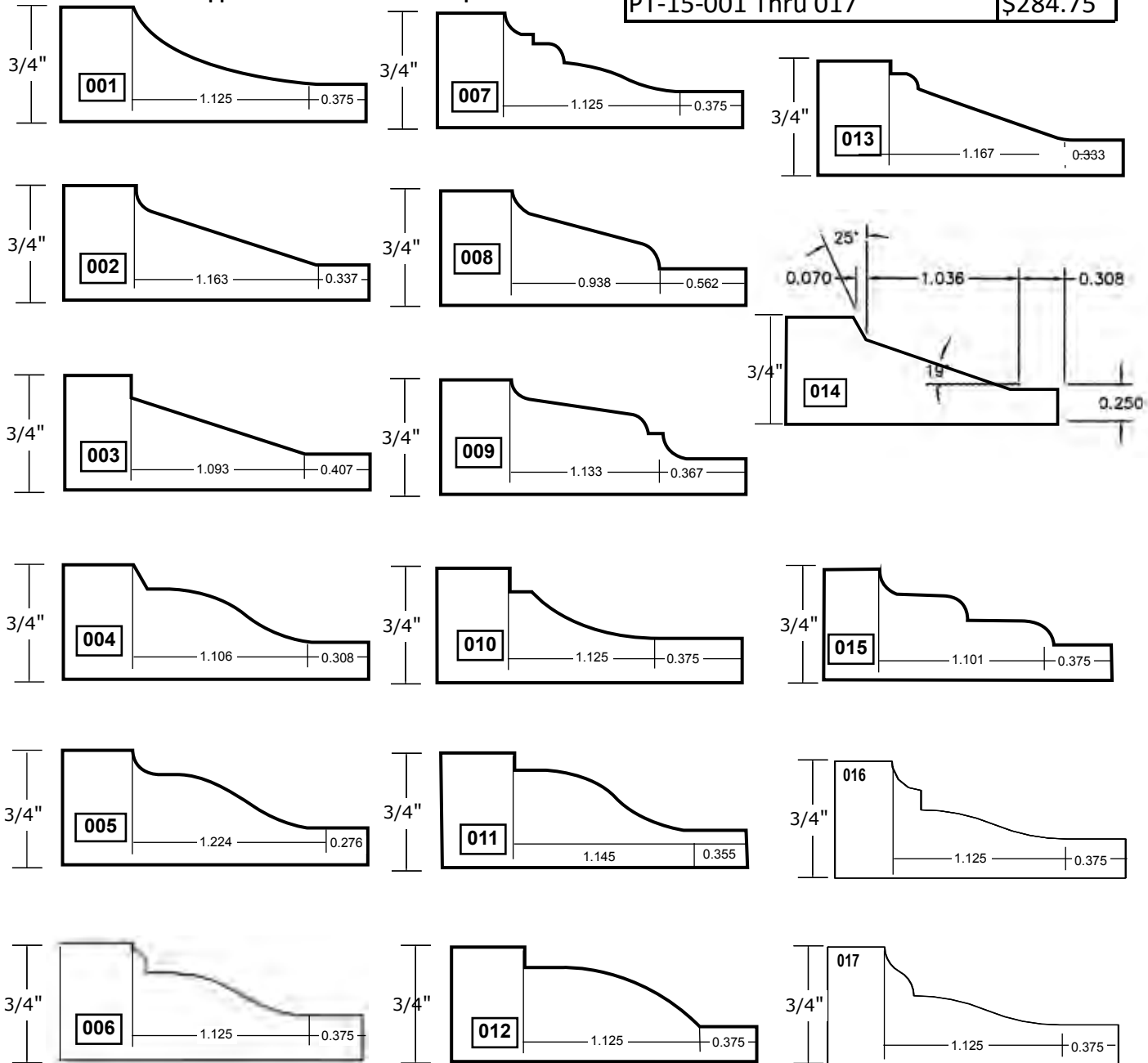

<p>3 wing • 6" diameter • 1-1/4" bore • Runs with a 3" • diameter rub bearing (AP-90-048)</p> <p>\$55.25</p>	<p>3 wing • 4-1/2" diameter • 3/4" bore • Runs with a 1-5/8" • diameter rub bearing (AM-90-026)</p> <p>\$48.45</p>
---	---

FREEBORN

Raised Panel Shaper Cutters (5/8" Material) Wood
samples shown actual size. Use with a backcutter to cut 3/4" material.

Part #	Price
MC-55-001 Thru 017	\$220.15
PC-15-001 Thru 017	\$258.40
MT-55-001 Thru 013 (Limited Supply)	\$150.88
PT-15-001 Thru 017	\$284.75

For opposite rotation add 20% to the price.

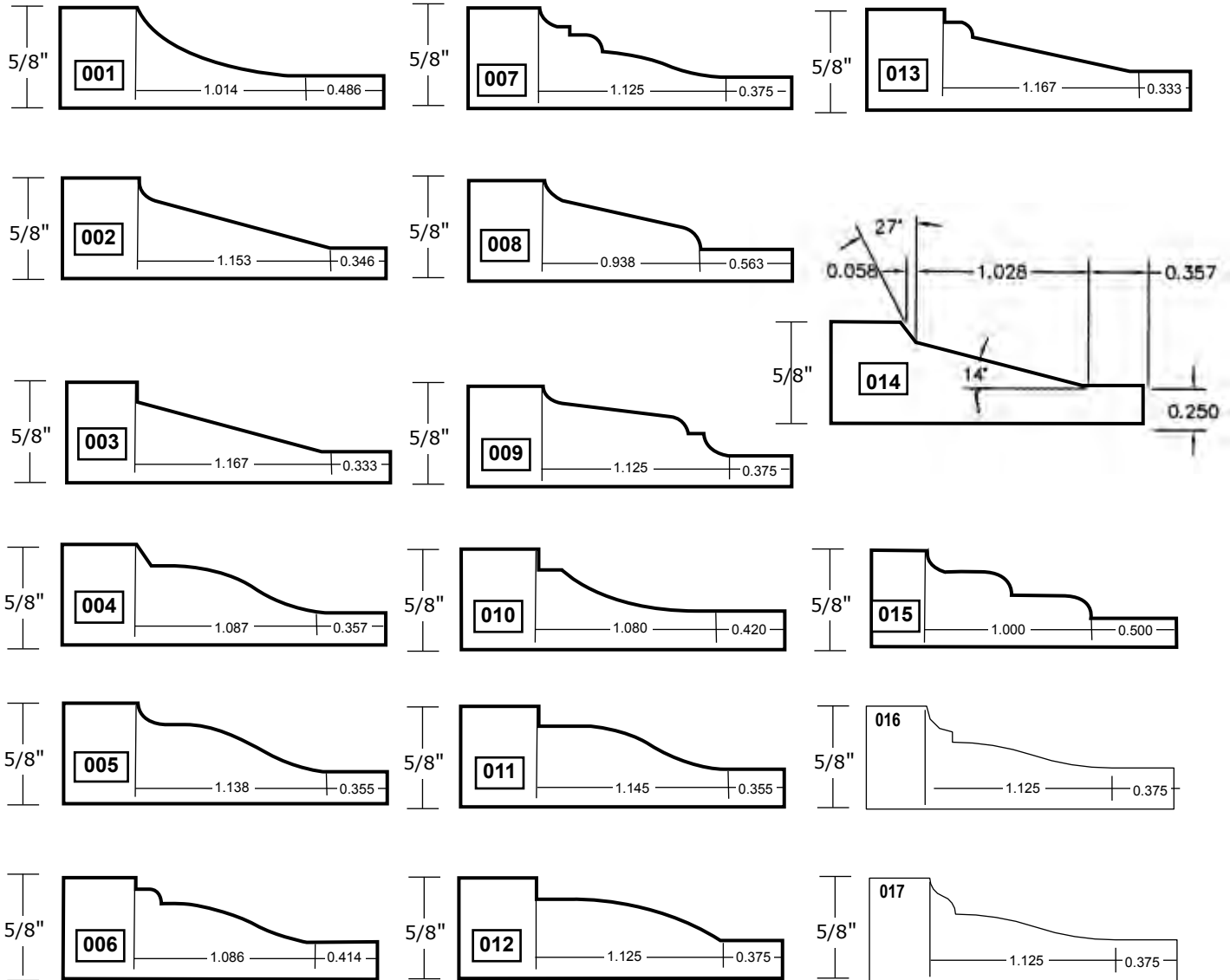

<p>3 wing • 6" diameter • 1-1/4" bore • Runs with a 3" • diameter rub bearing (AP-90-048) \$55.25</p>	<p>3 wing • 4-1/2" diameter • 3/4" bore • Runs with a 1-5/8" • diameter rub bearing (AM-90-026) \$48.45</p>
---	---

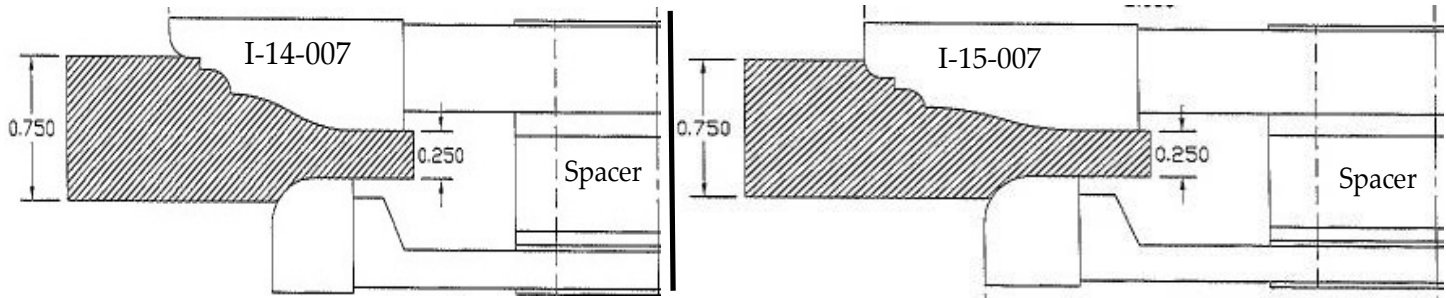

- The pictures above show what happens when you use the “14” Series cutters, above, on 3/4” material & use a back cutter.
- You lose off the top what you cut off the back of the panel.

Back Cutters-Raised Panel (3/4"Material)

<p>MINI-PRO cutters</p> <ul style="list-style-type: none"> • 3wing •3-3/8" diameter • 3/4" bore <p>Use 1-5/8 Diameter Rub Bearing AM-90-026, \$48.45</p>	<p>PRO-LINE cutters</p> <ul style="list-style-type: none"> • 3wing •4-3/4" diameter • 1-1/4" bore <p>Use 3" Diameter Rub Bearing AP-90-048, \$55.25</p>	<p><i>Does not include Raised Panel Cutter</i></p>
--	---	--

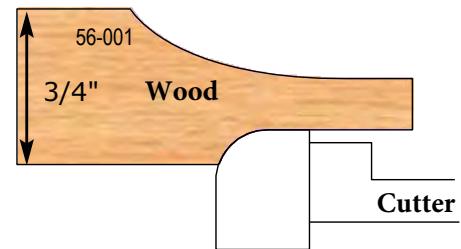

Use with a 55/15 series raised panel for 3/4" material.

Part #	Price
MC-56-001 or 002	\$160.65
PC-16-001 or 002	\$189.55
MT-56-001 or 002 (Limited Supply)	\$110.50
PT-16-001 or 002	\$208.25

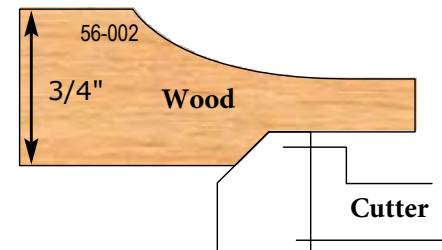

Raised Panel Tongue Trimmer

Part #	Price	Diameter
MC-56-100	\$63.72	1-5/8
PC-16-100	\$76.50	3
MT-56-100 (Limited Supply)	\$66.94	1-5/8
PT-16-100	\$85.00	3

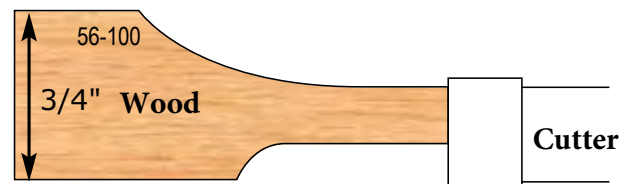

FREEBORN

Raised Panel Shaper Cutters - for 1/2" Material or 3/4" Material Double-Sided
6-1/2" Diameter

PART	PRICE
PC-15-101	\$258.40
PC-15-102	\$258.40
PC-15-103	\$258.40
PT-15-101	\$284.75
PT-15-102	\$284.75
PT-15-103	\$284.75

TOP AND BOTTOM CARBIDE CUTTERS WITH BEARING

PART	PRICE
PC-15-101TB	\$701.89
PC-15-102TB	\$701.89
PC-15-103TB	\$701.89

TOP AND BOTTOM TANTUNG® CUTTERS WITH BEARING

PART	PRICE
PT-15-101TB	\$772.08
PT-15-102TB	\$772.08
PT-15-103TB	\$772.08

Manufactured with 15° shear to produce optimum cuts both with and across the grain. These raised panel cutters cut a 1-3/8" reveal, plus a 3/8" long tongue. Reduce production time by adding an opposite rotation cutter to those above, and produce double side raised panels in a single pass. Rub bearing, spacers and tongue trimmers available.

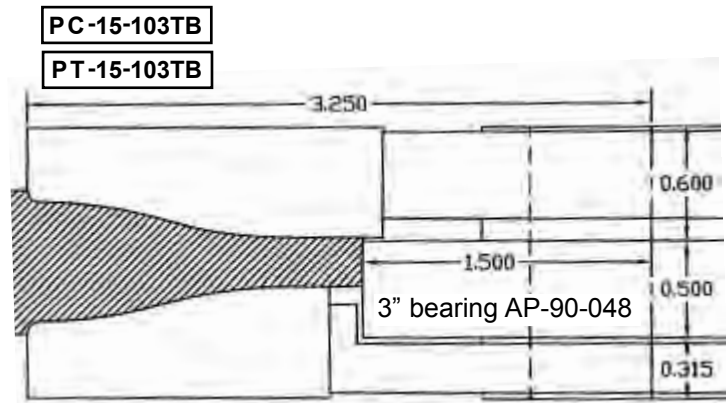
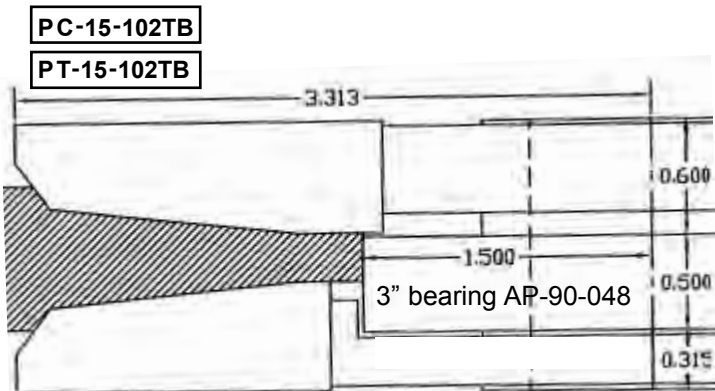
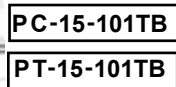
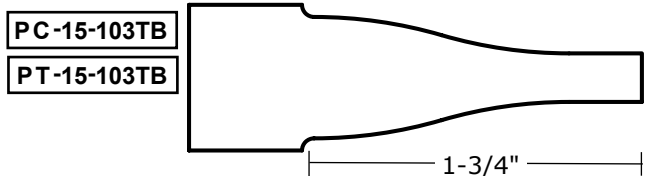
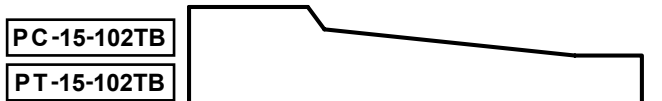
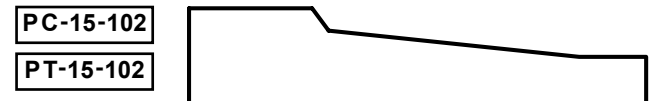
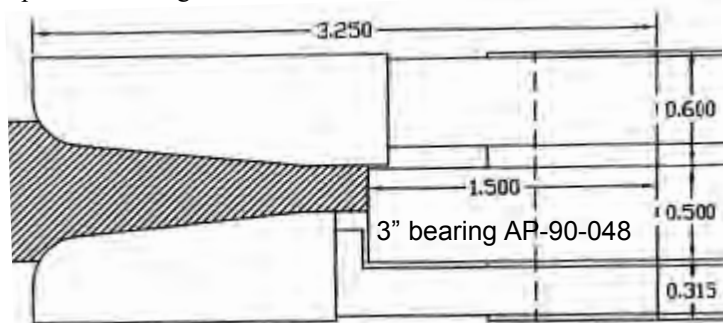

FREEBORN

Raised Panel Shaper Cutter

PC-14/15-201 thru 205 = \$310.25

PT-14/15-201 thru 205 = \$340.00

PRO-LINE cutters
3 wing • 1-1/4" bore • 2-1/2" depth of cut •
Designed to run with a 2-1/4" diameter rub bearing (AP-90-036) •
Available in Pro-Line only •

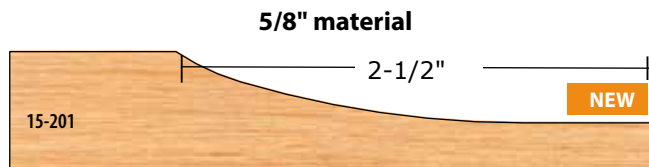
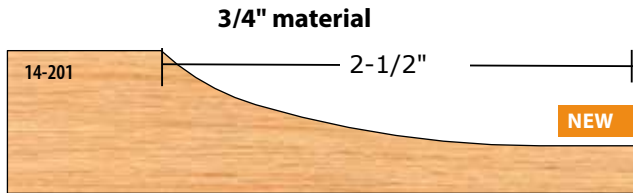

FREEBORN Door Edge Detail Shaper Cutters

All of these wood samples are full scale as shown. Whether it is a 30° back bevel, fingerpull, 3/8" offset, or flush overlay door, we offer a wide selection to choose from.

Counter clockwise rotation with wood fed face up.

For **opposite rotation**, add 20% to the price.

Wood samples shown actual size.

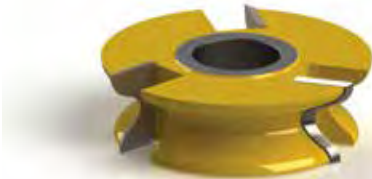

MINI-PRO cutters	PRO-LINE cutters
• 3 wing • 2-15/16" diameter • 3/4" bore • 1" wide tips	• 3 wing • 4" diameter • 1-1/4" bore • 1" wide tips

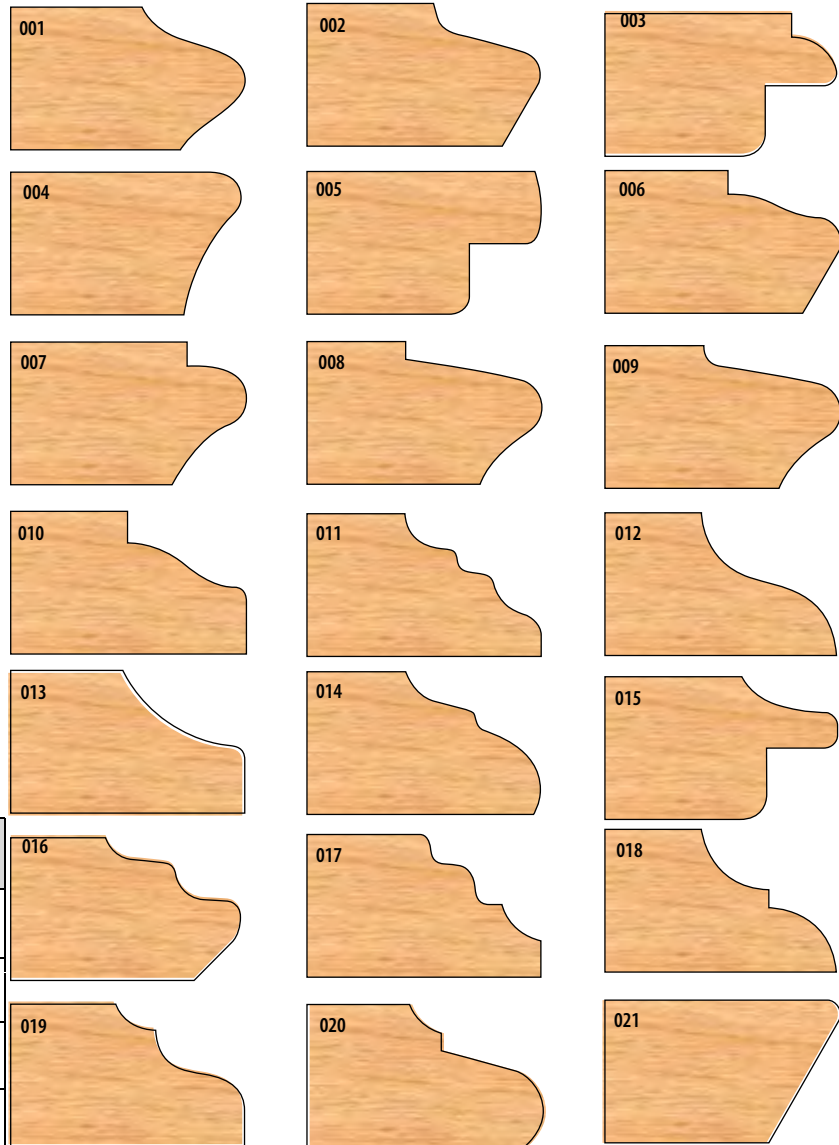

Part #	Price
MC-57-001 thru 032	\$173.40
PC-17-001 thru 032	\$204.00
PT-17-001 thru 032	\$224.40
MT-57-001 thru 032 (Limited Supply)	\$119.00

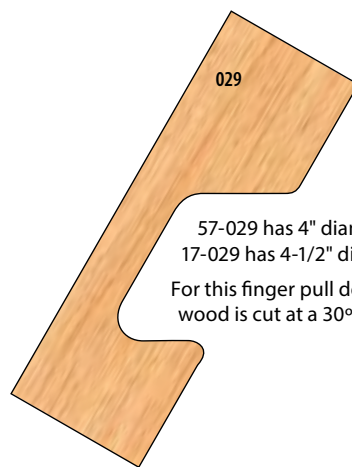
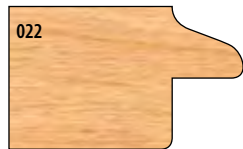

57-029 has 4" diameter
17-029 has 4-1/2" diameter
For this finger pull detail, the wood is cut at a 30° incline.

Similar to 002 profile
but .100 backout

FREEBORN

Door Edge Details

(32mm Hinge System)

Top Cutter Profiles

Part number is for top cutter only.

Manufactured with 15° SHEAR to produce optimum cuts both with and across grain.

Counterclockwise rotation with wood fed face up.

For **opposite rotation** add 20% to list price.

Any top cutter is designed to nest and run with any bottom cutter.

Wood samples shown actual size.



MINI-PRO cutters	PRO-LINE cutters
3-wing -2-1/16" minor diameter 3/4" bore	3-wing 3-1/16" minor diameter 1-1/4" bore
Major diameter varies with depth of cut	

3/4" to 7/8" material

Part #	Price
MC-57-101 thru 116	\$173.40
PC-17-101 thru 116	\$204.00
MT-57-101 thru 116 (Limited Supply)	\$119.00
PT-17-101 thru 116	\$224.40

Bottom Cutter Profiles

Bottom cutters for 32mm Hinge Systems are designed to nest and run with any top cutter listed.

Selection of bottom cutter should depend upon the distance of the bored hole for the hinge from the edge of the door.

Manufactured to the same specifications as all top cutters.

* Will not run with 32mm hinge system

* Will not run with 32mm hinge system

Part #	Price
MC-57-181 thru 185	\$136.85
PC-17-181 thru 185	\$161.50
MT-57-181 thru 185 (Limited Supply)	\$94.03
PT-17-181 thru 185	\$177.65

FREEBORN

Door Edge Details

(32mm Hinge System)

Top Cutter Profiles 7/8" to 1"

material Part number is for top cutter only.

PRO-LINE cutters	MINI-PRO cutters
3-wing 1-1/4" bore 1" wide tips	3-wing 3/4" bore 1" wide tips

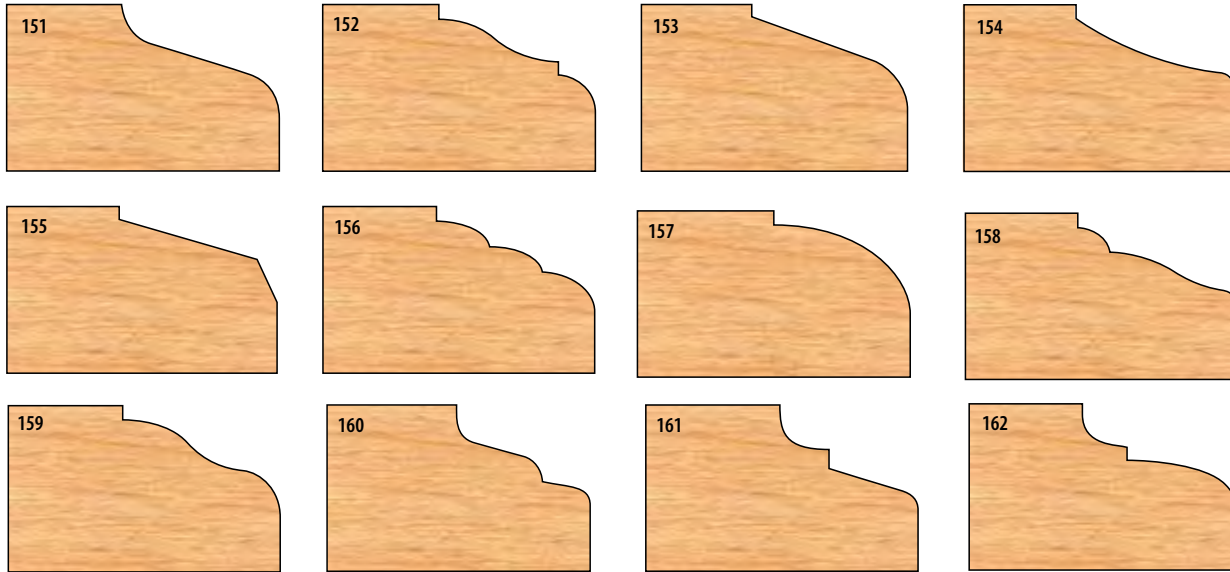

Part #	Price
MC-57-151 thru 162	\$173.40
PC-17-151 thru 162	\$204.00
MT-57-151 thru 162 (Limited Supply)	\$119.00
PT-17-151 thru 162	\$224.40

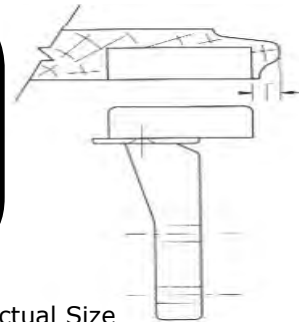

Not Actual Size

Door Edge Detail Bevel Cutters

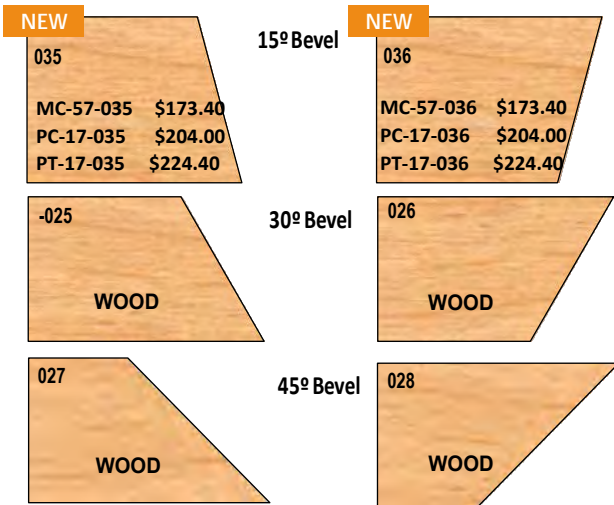

Wood samples shown actual size.

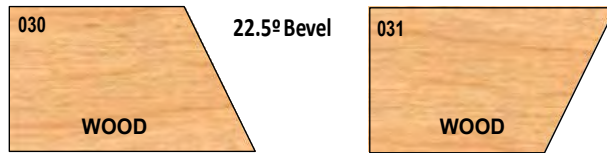

Part #	Price
MC-57-025, 026, 030, 031	\$141.10
PC-17-025, 026, 030, 031	\$165.75
MT-57-025, 026, 030, 031 (Limited Supply)	\$96.69
PT-17-025, 026, 030, 031	\$182.75
MC-57-027, 028	\$152.15
PC-17-027, 028	\$179.35
MT-57-027, 028 (Limited Supply)	\$104.66
PT-17-027, 028	\$197.20

FREEBORN Window Sill Cutters

Edge Detail cutters for up to 1" material.

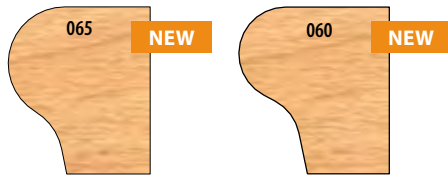

PRO-LINE cutters

3 wing • 4" diameter • 1-1/4" bore • 1-1/8" tips •

MINI-PRO cutters

3 wing • 2-15/16" diameter • 3/4" bore • 1-1/8" tips •

Part#	Price
MC-57-060 & 065	\$173.40
PC-17-060 & 065	\$204.00
PT-17-060 & 065	\$224.40

Reversible Glue Joint

Creates an incredibly strong joint by interlocking the glue surfaces.

MINI-PRO cutters

• 3 wing • 2-15/16" diameter • 3/4" bore • 1" wide tips • Cuts from 1/2" to 7/8" material

PRO-LINE cutters

• 3 wing • 2-15/16" diameter • 1-1/4" bore • 2" wide tips • Cuts from 1/2" to 1-7/8" material



Part #	Price
MC-58-001	\$182.75
PC-18-001	\$233.75
MT-58-001 (Limited Supply)	\$162.03
PT-18-001	\$259.25

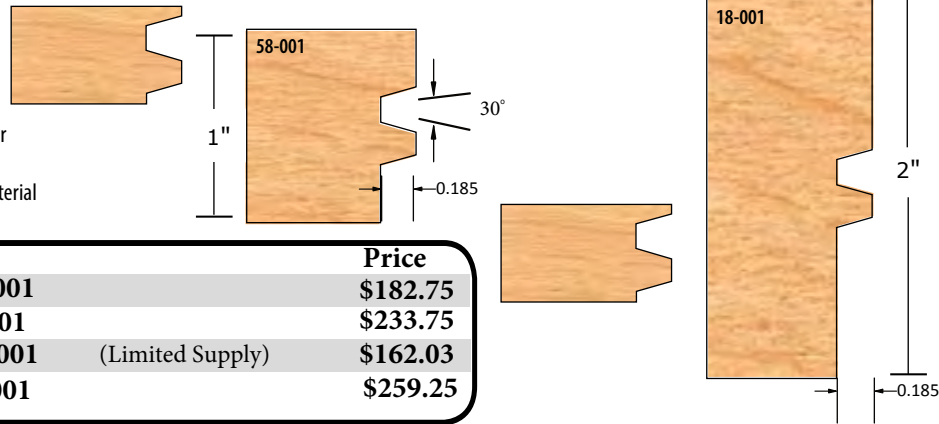

Wedge Tongue & Groove

MINI-PRO cutters

• 3 wing • 3/4" bore • 1" material

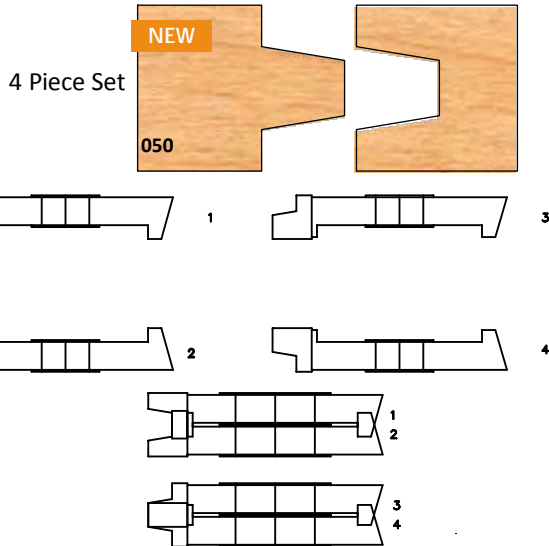

Part #	Price
MC-59-050	\$382.50
PC-19-050	\$437.75
PT-19-050	\$480.25

Comes with (4) AP-94-002 and (2) AP-94-004

PRO-LINE cutters

• 3 wing • 1-1/4" bore • 1" material

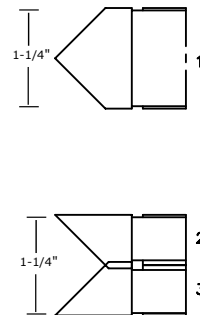

Edge Banding

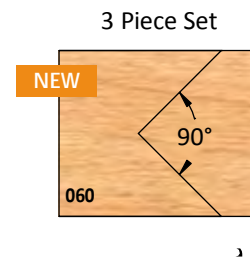

Part #	Price
MC-59-060	\$357.00
PC-19-060	\$378.25
PT-19-060	\$420.75

FREEBORN Bead Cutters

2-15/16 DIA

MINI-PRO cutters
3-wing
3/4" bore 1" wide tips

PRO-LINE cutters
3-wing
1-1/4" bore 1" wide tips **4" DIA**

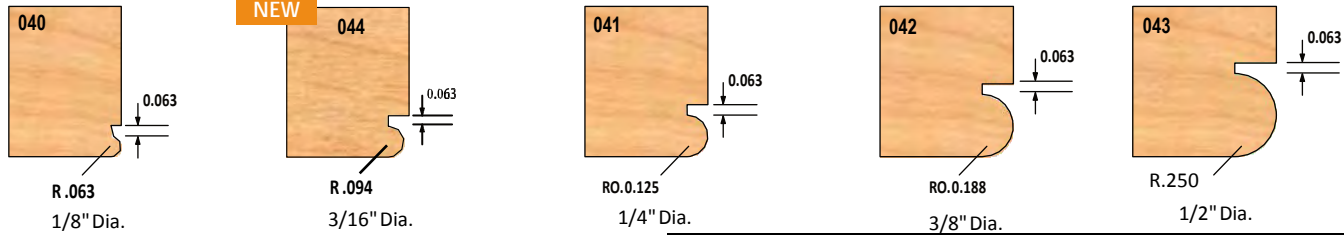

Part #	Price
MC-57-040, 044, 041	\$119.85
PC-17-040, 044, 041	\$141.10
MT-57-040, 044, 041 (Limited Supply)	\$82.88
PT-17-040, 044, 041	\$155.55

Part #	Price	Part #	Price
MC-57-042	\$128.35	MC-57-043	\$141.94
PC-17-042	\$151.30	PC-17-043	\$166.60
MT-57-042	\$78.09	MT-57-043	\$97.22
PT-17-042	\$166.60	PT-17-043	\$183.60

PRO-LINE cutters
3-wing
1-1/4" bore

Handrail Cutters (2 Piece Set)

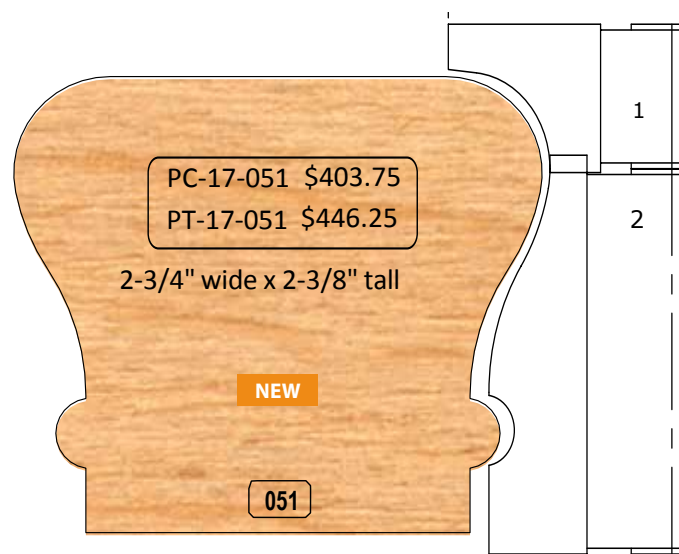
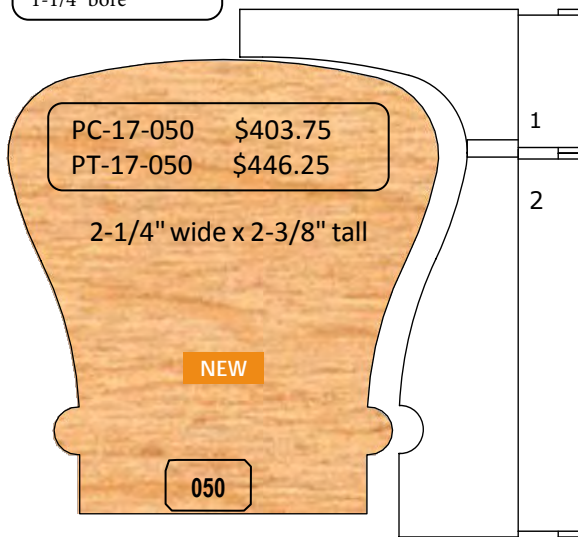
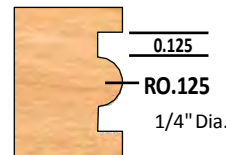
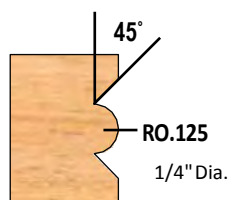

Table Saw Bead Cutters

- 6 wing Alternate Shear Face
- 5/8" bore
- 8" diameter



TSB-1 \$293.25

TSB-2 \$293.25

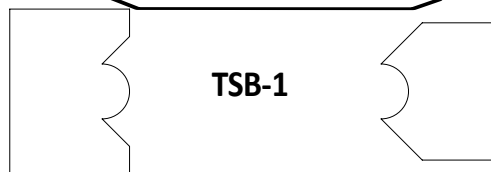

FREEBORN

V-Paneling Shaper Cutter Set

3/4" to 1" Material

PART	PRICE
MC-59-010	\$454.75
PC-19-010	\$535.50
MT-59-010 (Limited Supply)	\$312.96
PT-19-010	\$589.05

The V-Paneling set consists of 5 cutters and 1 spacer allowing you to perform the following 4 functions. **Counterclockwise rotation with wood fed face down.**



Cutter Stacking for V-Paneling Cutter Sets

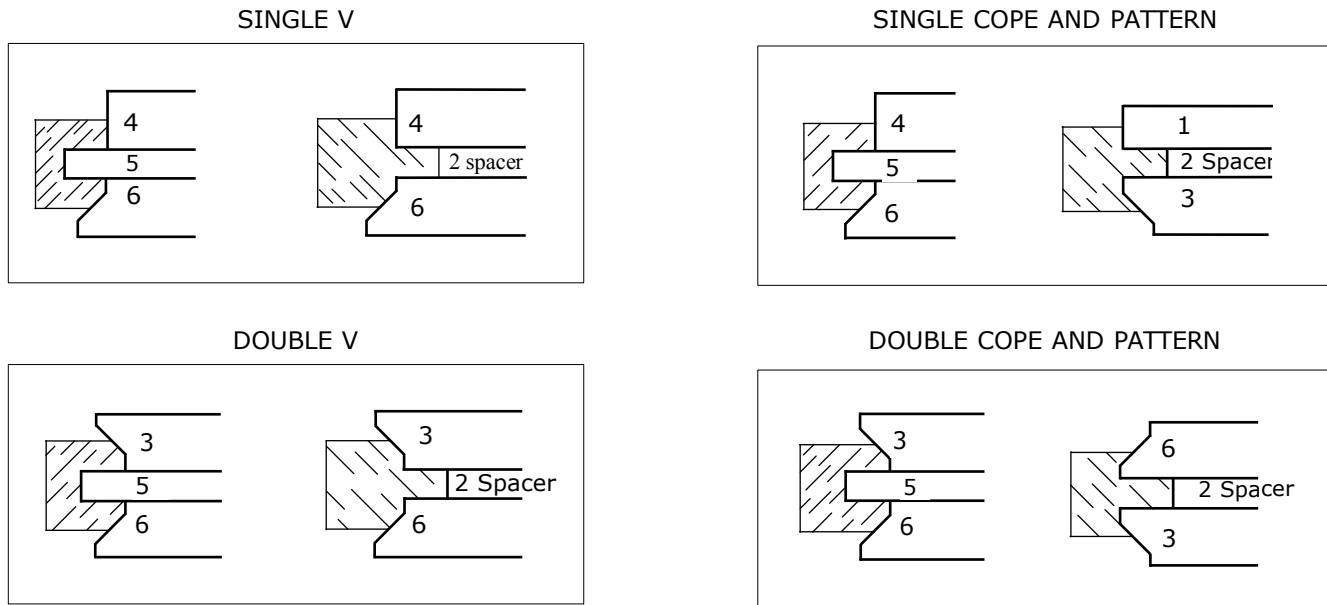

Freeborn Can Modify V-Panelling Set, So That Customers Could Use 2 Shapers with 3 Cutters On Each Shaper to Increase Production. Call For More Information

FREEBORN

5 Piece Flooring Set with Nail Slot

PART	PRICE
MC-59-030	\$454.75
PC-19-030	\$535.50
MT-59-030 (Limited Supply)	\$312.96
PT-19-030	\$589.05

This set includes 5 cutters to perform the cut as shown up to 1-1/8" material.

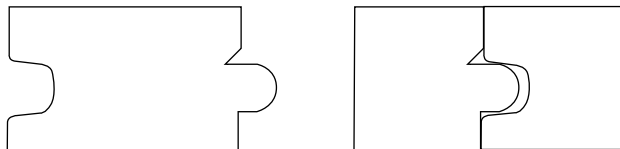
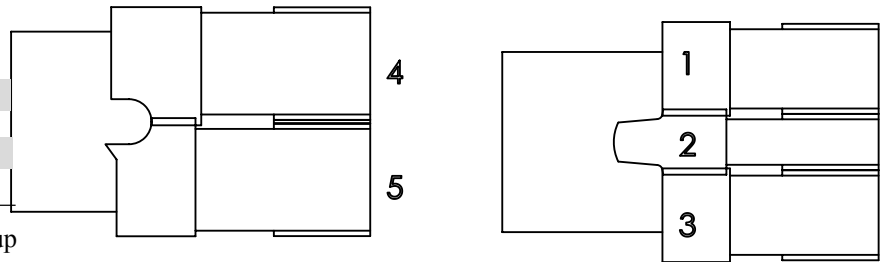

Diagram of Cutter Stacking for 5 Piece Flooring Sets.
Always check spindle and fence alignment. All cutters run counter-clockwise rotation with wood face down.

7 Piece Floor Set

ALL PROFILES ARE DESIGNED TO HAVE A .030" GAP

PART	PRICE
MC-59-020	\$454.75
PC-19-020	\$535.50
MT-59-020 (Limited Supply)	\$312.96
PT-19-020	\$589.05

The flooring set consists of 6 cutters and 1 spacer to perform these 5 functions. Cut provides a loose fit for wood expansion. Set up instructions included.

Mini-Pro Cutters: 3 wing, 2-15/16" diameter, 3/4" bore
Pro-Line Cutters: 3 wing, 4" diameter, 1-1/4" bore

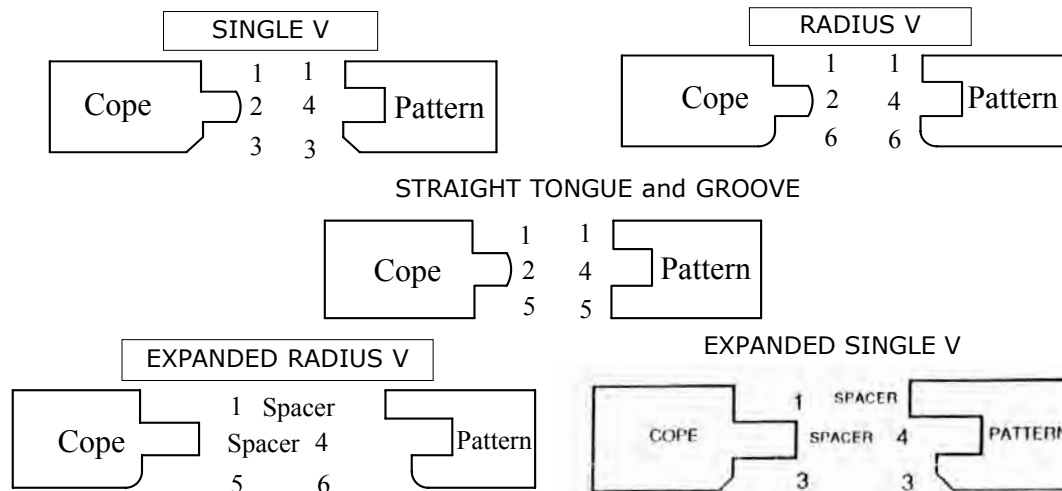
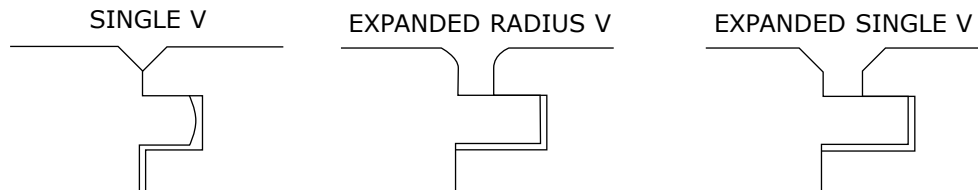
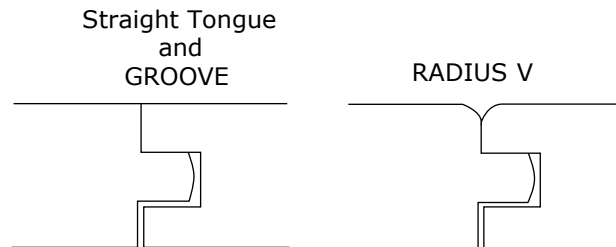

FREEBORN 8 Piece Floor Set for 1/2" Material

This 8 Piece Floor Set produces both profiles shown below, with their respective stacking instructions shown below.

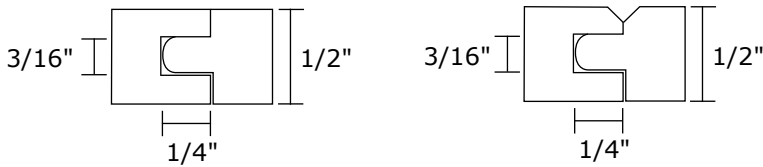

PART	PRICE
MC-59-040	\$454.75
PC-19-040	\$535.50
MT-59-040 (Limited Supply)	\$312.96
P T-19-040	\$589.05

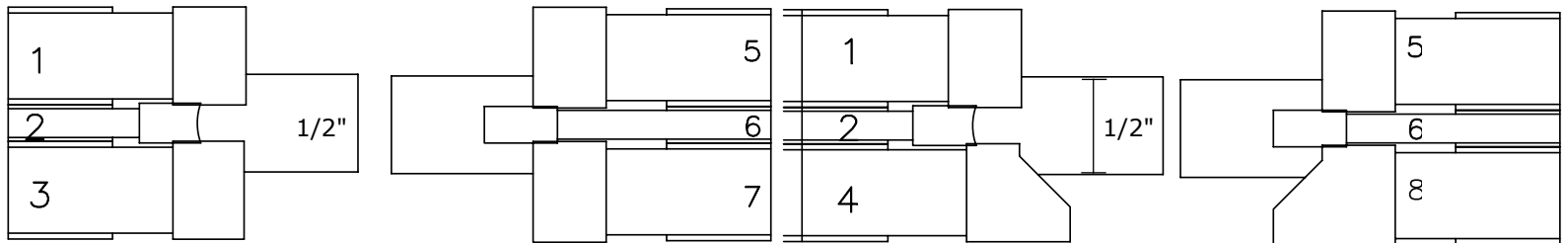

Window Sash Cutter Set (4 Piece Cutter Set)

PART	PRICE
MC-67-010 or 020	\$395.25
PC-27-010 or 020	\$494.70
MT-67-010 or 020 (Limited Supply)	\$272.00
PT-27-010 or 020	\$544.00

These window sash profiles are common in many older homes. The 4 cutter set is made to cut stock up to **1-3/4"**.

Counterclockwise rotation with wood fed face down.

MINI-PRO cutters

• 3 wing • 2-15/16" diameter
• 3/4" bore

PRO-LINE cutters

• 3 wing • 4" diameter
• 1-1/4" bore

010

1/4"

020

1/4"

Rabbet Depth is 1/4"

1-Piece Double Easing Cutters

Custom rub bearings available for these cutters.

MINI-PRO cutters

3 wing • 2-15/16" diameter • 3/4" bore •

PRO-LINE cutters

3 wing • 4" diameter • 1-1/4" bore •

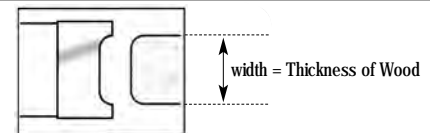

Part #	Price	Part #	Price	Part #	Price	Part #	Price	Width	Radius
MC 71-006	\$66.30	MT 71-006	\$82.88	PC 31-006	\$77.35	P T 31-006	\$85.85	3/8"	1/8"
MC 71-008	\$71.40	MT 71-008	\$89.25	PC 31-008	\$83.30	P T 31-008	\$91.80	1/2"	1/8"
MC 71-012	\$85.85	MT 71-012	\$106.78	PC 31-012	\$100.30	P T 31-012	\$110.50	3/4"	1/8"
MC 71-016	\$90.10	MT 71-016	\$112.63	PC 31-016	\$106.25	P T 31-016	\$117.30	1"	1/8"
MC 71-020	\$102.00	MT 71-020	\$128.03	PC 31-020	\$120.70	P T 31-020	\$132.60	1-1/4"	1/8"
MC 71-024	\$109.65	MT 71-024	\$137.60	PC 31-024	\$129.20	P T 31-024	\$142.80	1-1/2"	1/8"

FREEBORN

Quarter Cove Convex Cutters

PRO-LINE cutters

3 wing • 4" diameter • 1-1/4" bore •

MINI-PRO cutters

3 wing • 2-15/16" diameter • 3/4" bore •

Number	Price	Number	Price	Number	Price	Number	Price	Width
MC 60-002	\$60.35	MT 60-002	\$75.44	PC 20-002	\$70.55	PT 20-002	\$77.35	1/8"
MC 60-004	\$73.10			PC 20-004	\$85.85	PT 20-004	\$94.35	1/4"
MC 60-006	\$86.70	MT 60-006	\$107.85	PC 20-006	\$101.15	PT 20-006	\$111.35	3/8"
MC 60-008	\$96.05	MT 60-008	\$126.44	PC 20-008	\$113.05	PT 20-008	\$124.10	1/2"
MC 60-012	\$119.00	MT 60-012	\$153.00	PC 20-012	\$140.25	PT 20-012	\$154.70	3/4"

Counterclockwise rotation with wood fed face down.



Reversible Pattern Detail

PRO-LINE cutters

3 wing • 4" diameter • 1-1/4" bore • 1" wide tips •

MINI-PRO cutters

3 wing • 2-15/16" diameter • 3/4" bore • 1" wide tips •

Counterclockwise rotation with wood fed face up.

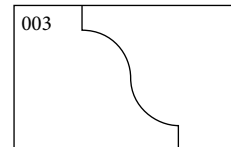
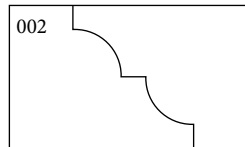
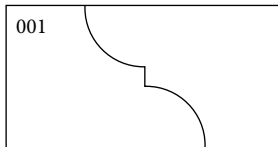

After machining two pieces of wood, one piece may be inverted and plugged into its mate, forming a matched joint.

Part #	Price
MC-61-001 thru 003	\$127.50
PC-21-001 thru 003	\$150.45
MT-61-001 thru 003 (Limited Supply)	\$159.38
PT-21-001 thru 003	\$164.90



Straight Top Groovers

PRO-LINE cutters

3 wing • 4" diameter • 1-1/4" bore • Designed for use with 4" diameter rub bearing for flush trim application

MINI-PRO cutters

3 wing • 2-15/16" diameter • 3/4" bore • Designed for use with 2-15/16" diameter rub bearing for flush trim application

Straight Top Groovers are ideal for cutting grooves, rabbets, and for flush trimming.

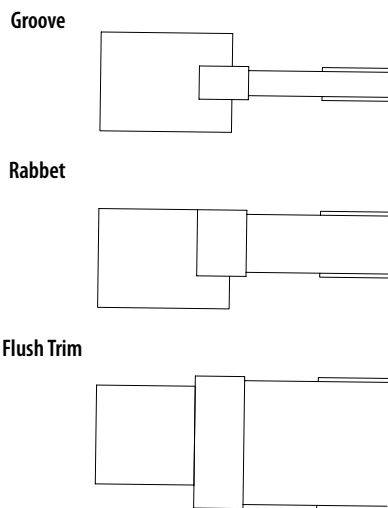

Number	Price	Number	Price	Number	Price	Number	Price	Width
MC 62-002	\$49.30	MT 62-002	\$61.09	PC 22-002	\$57.80	PT 22-002	\$63.75	1/8"
MC 62-003	\$49.30			PC 22-003	\$57.80	PT 22-003	\$63.75	3/16"
MC 62-004	\$49.30	MT 62-004	\$55.25	PC 22-004	\$57.80	PT 22-004	\$63.75	1/4"
MC 62-005	\$49.30	MT 62-005	\$58.44	PC 22-005	\$57.80	PT 22-005	\$63.75	5/16"
MC 62-006	\$49.30	MT 62-006	\$61.09	PC 22-006	\$57.80	PT 22-006	\$63.75	3/8"
MC 62-007	\$51.85	MT 62-007	\$64.28	PC 22-007	\$60.35	PT 22-007	\$66.30	7/16"
MC 62-008	\$53.55	MT 62-008	\$67.47	PC 22-008	\$63.75	PT 22-008	\$69.70	1/2"
MC 62-010	\$56.95	MT 62-010	\$70.66	PC 22-010	\$66.30	PT 22-010	\$73.10	5/8"
MC 62-012	\$58.65	MT 62-012	\$73.31	PC 22-012	\$68.85	PT 22-012	\$75.65	3/4"
MC 62-014	\$61.20	MT 62-014	\$76.50	PC 22-014	\$72.25	PT 22-014	\$79.05	7/8"
MC 62-016	\$63.75	MT 62-016	\$79.69	PC 22-016	\$74.80	PT 22-016	\$82.45	1"
MC 62-020	\$68.85	MT 62-020	\$86.06	PC 22-020	\$80.75	PT 22-020	\$89.25	1-1/4"
MC 62-024	\$75.65	MT 62-024	\$94.56	PC 22-024	\$89.25	PT 22-024	\$98.60	1-1/2"
MC 62-028	\$85.85	MT 62-028	\$106.78	PC 22-028	\$100.83	PT 22-028	\$110.50	1-3/4"
MC 62-032	\$92.65	MT 62-032	\$115.81	PC 22-032	\$108.80	PT 22-032	\$119.85	2"

FREEBORN

Half Round Convex Shaper Cutters

PRO-LINE cutters **MINI-PRO cutters**

3 wing • 4" diameter • 1-1/4" bore • 3 wing • 2-15/16" diameter • 3/4" bore •

Number	Price	Price	Price	Price	Width	Radius			
MC 63-002	\$53.55	MT 63-002	\$67.47	PC 23-002	\$63.75	PT 23-003	\$69.70	1/4"	1/8"
MC 63-003	\$58.65	MT 63-003	\$73.31	PC 23-003	\$68.85	PT 23-003	\$75.65	3/8"	3/16"
MC 63-004	\$66.30	MT 63-004	\$82.88	PC 23-004	\$77.35	PT 23-004	\$85.85	1/2"	1/4"
MC 63-006	\$73.10	MT 63-006	\$91.38	PC 23-006	\$85.85	PT 23-006	\$95.20	3/4"	3/8"
MC 63-008	\$92.65	MT 63-008	\$115.81	PC 23-008	\$108.80	PT 23-008	\$119.85	1"	1/2"

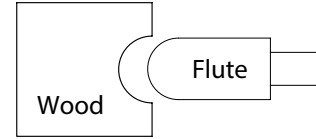

Half Round Concave Shaper Cutters

All Concave Cutters have .030" flare for easy bull nosing.

Number	Price	Price	Price	Price	Opening Width	Radius			
MC 64-002	\$66.30	MT 64-002	\$82.88	PC 24-002	\$77.35	PT 24-002	\$85.00	1/4"	1/8"
MC 64-003	\$70.55	MT 64-003	\$88.72	PC 24-003	\$83.30	PT 24-003	\$93.50	3/8"	3/16"
MC 64-004	\$78.20	MT 64-004	\$97.75	PC 24-004	\$89.25	PT 24-004	\$97.75	1/2"	1/4"
MC 64-006	\$108.80	MT 64-006	\$136.00	PC 24-006	\$165.75	PT 24-006	\$182.75	3/4"	3/8"
MC 64-008	\$129.20	MT 64-008	\$161.50	PC 24-008	\$208.25	PT 24-008	\$229.50	1"	1/2"
MC 64-009	\$134.30	MT 64-009	\$168.94	PC 24-009	\$216.75	PT 24-009	\$238.00	1-1/8"	9/16"
MC 64-010	\$153.00	MT 64-010	\$191.78	PC 24-010	\$233.75	PT 24-010	\$259.25	1-1/4"	5/8"
				PC 24-012	\$276.25	PT 24-012	\$306.00	1-1/2"	3/4"

Corner Rounding Shaper Cutters

Larger PRO-LINE Cutters exceed the standard 4" diameter (see chart).
R = CCW, wood face up

Counterclockwise rotation with wood fed face down.

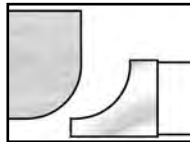

MINI-PRO cutters

• 3 wing • 2-15/16" diameter • 3/4" bore

PRO-LINE cutters

• 3 wing • 4" diameter (unless specified) • 1-1/4" bore

R=Opposite Rotation

Number	Price	Price	Price	Price	Radius	3/4" Bore Diameter	1-1/4" Bore Diameter			
MC 65-002	\$61.20	MT 65-002	\$76.50	PC 25-002	\$72.25	PT 25-002	\$79.05	1/8"	2-15/16"	4"
MC 65-002R	\$61.20	MT 65-003	\$86.06	PC 25-002R	\$72.25	PT 25-002R	\$79.05	1/8"	2-15/16"	4"
MC 65-003	\$68.85	MT 65-004R	\$91.38	PC 25-003	\$80.75	PT 25-003	\$89.25	3/16"	2-15/16"	4"
MC 65-004	\$73.10	MT 65-005	\$97.75	PC 25-004	\$85.85	PT 25-004	\$95.20	1/4"	2-15/16"	4"
MC 65-004R	\$73.10	MT 65-006	\$112.63	PC 25-004R	\$85.85	PT 25-004R	\$95.20	1/4"	2-15/16"	4"
MC 65-005	\$78.20	MT 65-006R	\$112.63	PC 25-005	\$91.80	PT 25-005	\$101.15	5/16"	2-15/16"	4"
MC 65-006	\$90.10	MT 65-008	\$112.63	PC 25-006	\$106.25	PT 25-006	\$117.30	3/8"	2-15/16"	4"
MC 65-006R	\$90.10	MT 65-008R	\$112.63	PC 25-006R	\$106.25	PT 25-006R	\$117.30	3/8"	2-15/16"	4"
MC 65-008	\$112.20	MT 65-010	\$146.63	PC 25-008	\$131.75	PT 25-008	\$145.35	1/2"	2-15/16"	4"
MC 65-008R	\$117.30	MT 65-012	\$158.31	PC 25-008R	\$131.75	PT 25-008R	\$145.35	1/2"	2-15/16"	4"
MC 65-010	\$126.65			PC 25-010	\$140.25	PT 25-010	\$151.30	5/8"	2-15/16"	4"
MC 65-012	\$230.35			PC 25-012	\$157.25	PT 25-012	\$164.05	3/4"	2-15/16"	4"
				PC 25-014	\$155.55	PT 25-014	\$170.85	7/8"	n/a	4-1/2"
				PC 25-016	\$164.05	PT 25-016	\$180.20	1"	n/a	4-1/2"
				PC 25-020	\$175.10	PT 25-020	\$192.95	1-1/4"	n/a	5"
				PC 25-024	\$206.55	PT 25-024	\$226.95	1-1/2"	n/a	5-1/2"
				PC 25-028	\$269.45	PT 25-028	\$295.80	1-3/4"	n/a	6-1/2"
				PC 25-032	\$377.40	PT 25-032	\$377.40	2"	n/a	6-1/2"

FREEBORN

Matched Drop Leaf

Counterclockwise rotation with wood face down. When running counterclockwise, cove cut is made by lowering shaper spindle to cut with the top half of the cutter. Bead cut is made by raising shaper spindle to cut with the bottom half of the cutter.

MINI-PRO cutters
 • 3 wing • 2-15/16" diameter
 • 3/4" bore

PRO-LINE cutters
 • 3 wing • 4" diameter
 • 1-1/4" bore

Part #	Price
MC-66-001	\$177.65
MT-66-001 (Limited Supply)	\$220.06
PC-26-001	\$210.80
PT-26-001	\$230.35

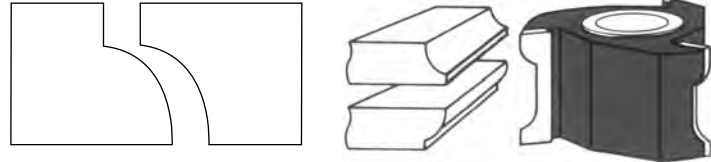

Drawer Lock Cutter

Run drawer front face up in horizontal position over the top of the cutter. Drawer sides are run on end in a vertical position against the shaper fence.

Made to cut up to 3/4" drawer sides.

Counterclockwise rotation only.

MINI-PRO cutters
 • 3 wing • 2-15/16" diameter
 • 3/4" bore

PRO-LINE cutters
 • 3 wing • 5" diameter
 • 1-1/4" bore

Part #	Price
MC-69-001	\$124.95
MT-69-001 (Limited Supply)	\$86.06
PC-29-001	\$147.05
PT-29-001	\$184.45

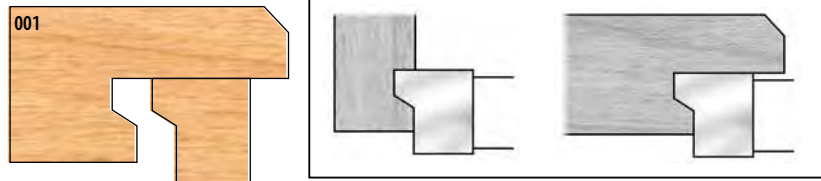

Two Piece Double Tongue & Groove Lock Miter Sets

NEW 2 Piece 3/4" - 1" material Set

PRO-LINE cutters
 • 3 wing
 • 1-1/4" bore
 • 5.19" diameter
 • 1-1/4" wide tips

Part #	Price
PC-28-025	\$335.75
PT-28-025	\$369.75

2 Piece Set

NEW 3/4" material

MINI-PRO cutters
 • 3 wing • 3/4" bore
 • 2-15/16" diameter
 • 1" wide tips

PRO-LINE cutters
 • 3 wing • 4" diameter
 • 1-1/4" bore
 • 1" wide tips

Part #	Price
MC-68-015	\$284.75
PC-28-015	\$335.75
PT-28-015	\$369.75

FREEBORN One Piece Double Tongue & Groove Lock Mitre Cutter



Counterclockwise rotation only. Mini-Pro is made to run only on 3/4" spindle.

Part B is run flat in horizontal position on shaper table.

Part A is run in a vertical position against the shaper fence.

1/2" material

MINI-PRO cutters

- 3 wing • 3/4" bore
- 2-15/16" diameter
- 3/4" wide tips

PRO-LINE cutters

- 3 wing • 1-1/4" bore
- 4" diameter
- 3/4" wide tips

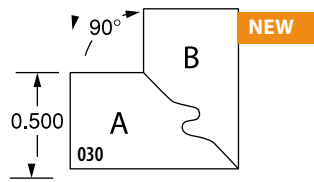

3/4" - 1" material

MINI-PRO cutters

- 3 wing • 3/4" bore
- 4.05" diameter
- 1-1/8" wide tips

PRO-LINE cutters

- 3 wing • 1-1/4" bore
- 5.05" diameter
- 1-1/8" wide tips

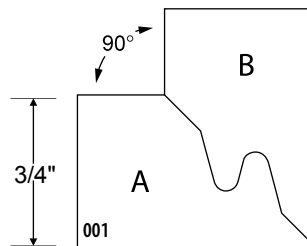

1-1/2" material

PRO-LINE cutters

- 1-1/4" bore • 6" diameter
- 3 wing • 1-3/4" wide tips

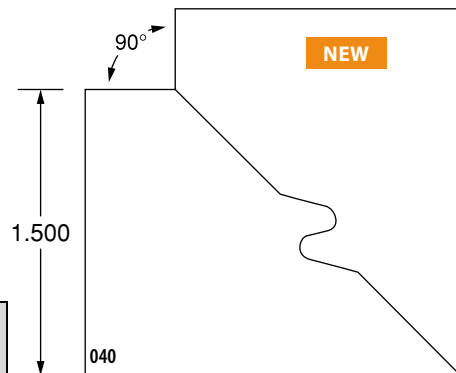

Part #	Price
MC-68-030	\$208.25
PC-28-030	\$245.65
PT-28-030	\$270.30

Part #	Price
MC-68-001	\$252.45
PC-28-001	\$297.50
PT-28-001	\$327.25

Part #	Price
PC-28-040	\$445.40
PT-28-040	\$489.60

Single Tongue & Groove Lock Miter Cutter (3 Piece Cutter Set)

Counterclockwise rotation only. Mini-Pro is made to run only on 3/4" spindle.

Material to 1-1/8".

Part A and B are both run flat in horizontal position on shaper table. Part B is run again on table saw to cut groove (see diagram).

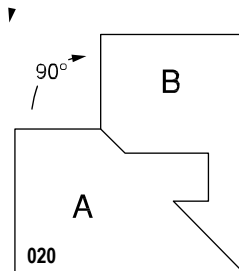

MINI-PRO cutters

- 3 wing • 5-3/8" diameter • 3/4" bore • Use on 3/4" spindles only

PRO-LINE cutters

- 3 wing • 4-5/16" diameter • 1-1/4" bore

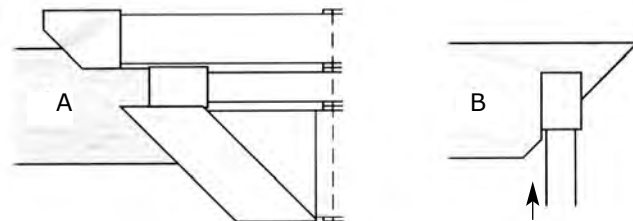

Part #	Price
MC-68-020	\$292.40
MT-68-020 (Limited Supply)	\$201.34
PC-28-020	\$344.25
PT-28-020	\$378.25

You can use a Dado set or groover on a table saw for this cut. Ask Ballew Saw & Tool for advice.

FREEBORN

Extended Corner Rounds

PART #	PRICE	PART #	PRICE	PART #	PRICE	PART #	PRICE
MC-73-002	\$87.55	MC-73-004	\$97.75	MC-73-006	\$108.80	MC-73-008	\$120.70
PC-33-002	\$103.70	PC-33-004	\$114.75	PC-33-006	\$127.50	PC-33-008	\$142.80
MT-73-002	\$109.97	MT-73-004	\$122.19	MT-73-006	\$136.00	MT-73-008	\$151.41
PT-33-002	\$113.90	PT-33-004	\$126.65	PT-33-006	\$141.10	PT-33-008	\$157.25

Mini-Pro Cutters: 3 wing, 2-15/16" diameter, 3/4" bore

Pro-Line Cutters: 3 wing, 4" diameter, 1-1/4" bore

Counterclockwise rotation with wood face down. For up to 1-1/4" material.

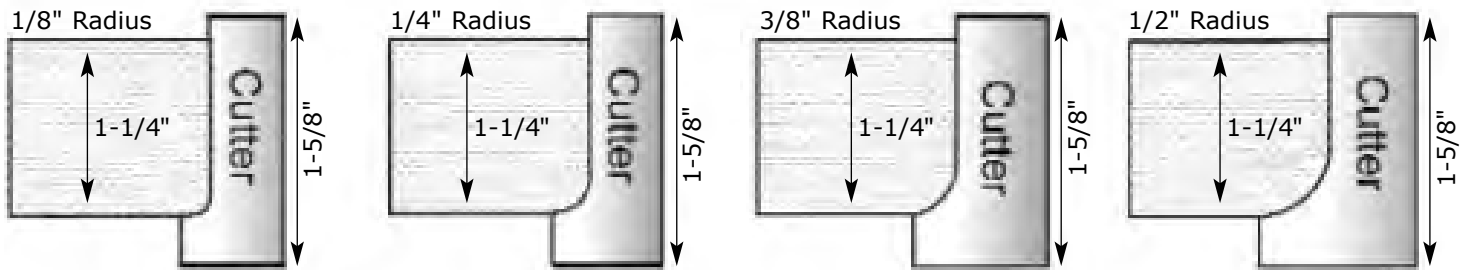

4-Piece Expandable Double Easing Set

PART	RADIUS	PRICE
MC-72-002	1/8	\$219.30
PC-32-002	1/8	\$257.55
MT-72-002	1/8	\$275.60
PC-72-002	1/8	\$283.05
MC-72-004	1/4	\$219.30
PC-32-004	1/4	\$272.00
MT-72-004	1/4	\$289.00
PT-32-004	1/4	\$299.20

MINI-PRO cutters

- 3 wing • 2-3/16" minor diameter
- 3/4" bore

PRO-LINE cutters

- 3 wing • 3" minor diameter
- 1-1/4" bore

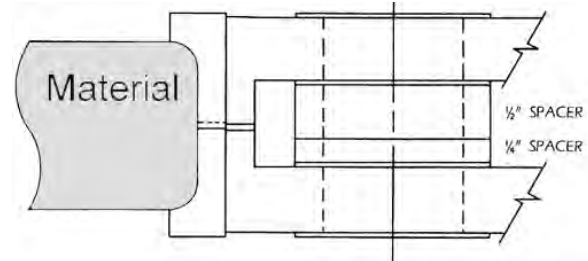

- 3 wing, 3" minor diameter 1-1/4" bore.
- Either Counterclockwise or Clockwise rotation.
- Each set includes 2 cutters with matched radii and 2 spacers.
- Cut 3/4", 1", 1-1/4", and radii can be interchanged.
- Cutter sets can also be shimmed for additional width variations.
- **M** Sets have 2-3/16" minor diameter.
- **P** sets have 3" minor diameter.

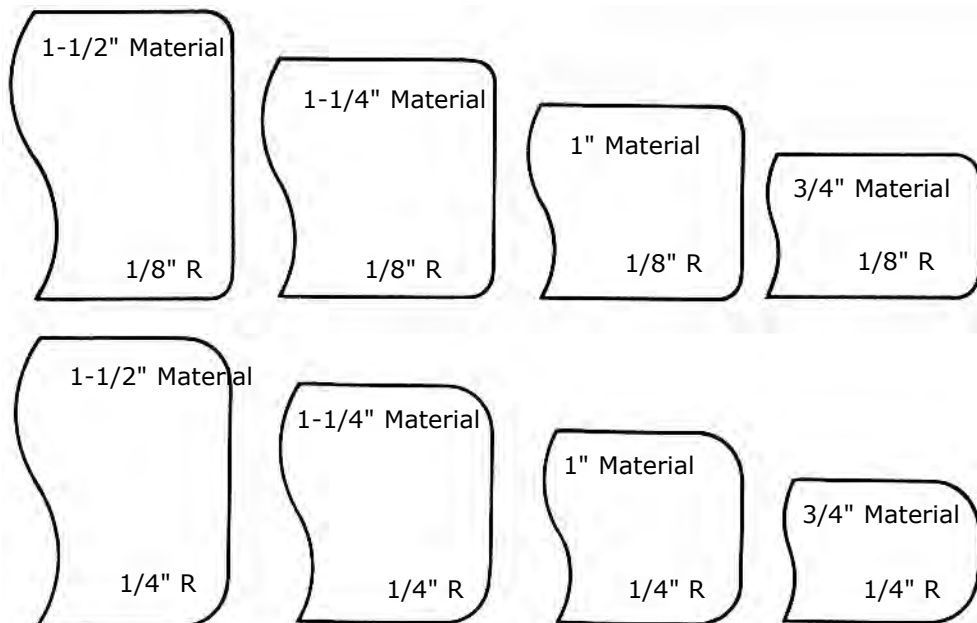

FREEBORN

Ball Bearing Rub Collars

Part #	Bore	Diameter	Thickness	Price
AM 90-026	3/4"	1-5/8"	7/16"	\$48.45
AM 90-027	3/4"	1-11/16"	7/16"	\$48.45
AM 90-033	3/4"	2-1/16"	7/16"	\$48.45
AM 90-035	3/4"	2-3/16"	7/16"	\$48.45
AM 90-039	3/4"	2-7/16"	7/16"	\$48.45
AM 90-047	3/4"	2-15/16"	7/16"	\$48.45

Part #	Bore	Diameter	Thickness	Price
AP 90-036	1-1/4"	2-1/4"	1/2"	\$52.25
AP 90-040	1-1/4"	2-1/2"	1/2"	\$55.25
AP 90-044	1-1/4"	2-3/4"	1/2"	\$55.25
AP 90-048	1-1/4"	3"	1/2"	\$55.25
AP 90-049	1-1/4"	3-1/16"	1/2"	\$55.25
AP 90-052	1-1/4"	3-1/4"	1/2"	\$55.25
AP 90-056	1-1/4"	3-1/2"	1/2"	\$55.25
AP 90-060	1-1/4"	3-3/4"	1/2"	\$55.25
AP 90-064	1-1/4"	4"	1/2"	\$55.25

Custom Ball Bearing Rub Collars are Available. 6" or less = **\$75.00**

Rub Spacers for Cope and Pattern Sets

PART	BORE	TONGUE	PRICE	PART	BORE	TONGUE	PRICE
AM-50-801	3/4	1/4 x 1/2	\$31.45 Each	AP-10-801	1-1/4	1/4 x 1/2	\$35.70 Each
AM-50-803	3/4	1/4 x 3/8	\$31.45 Each	AP-10-803	1-1/4	1/4 x 3/8	\$35.70 Each
AM-50-806	3/4	5.5mm x 3/8	\$31.45 Each	AP-10-806	1-1/4	5.5mm x 3/8	\$35.70 Each
AM-50-807	3/4	5.5mm x 1/2	\$31.45 Each	AP-10-807	1-1/4	5.5mm x 1/2	\$35.70 Each

Optional rub spacer available for **M-50** and **P-10** series cope and pattern sets. Replaces center cutter on cope side.

NOTE: Not a Ball Bearing Spacer



T-Bushings

Choose from

- **Long Style** - for 3 to 6 Cutter Sets. Consists of 1 long and 1 short T-Bushing.
- **Short Style** - for Single Cutters. Consists of 2 short T-Bushings.
- **Double Sided** - to run between Cutter and Bearing.

Number	Bore	Width	Price
AM 91-008	1/2"	3/4"	\$17.00
AX 91-012	3/4"	1"	\$17.00
AP 91-012	3/4"	1-1/4"	\$17.00
AP 91-016	1"	1-1/4"	\$17.00
AP 91-016 XL*	1"	1-1/4"	\$17.00
AP 91-017	30mm	1-1/4"	\$17.00
AP 91-018	1-1/8"	1-1/4"	\$17.00

*for use with double sided Cope and Pattern sets

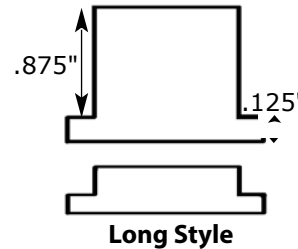

Number	Bore	Width	Price
AM 93-008	1/2"	3/4"	\$10.20
AP 93-008	1/2"	1-1/4"	\$10.20
AP 93-012	3/4"	1-1/4"	\$10.20
AP 93-016	1"	1-1/4"	\$10.20
AP 93-018	1-1/8"	1-1/4"	\$10.20

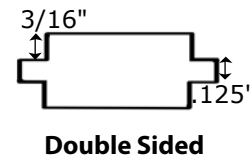

S-TB 1-1/2 Bore
1-1/4 Width **\$35.90**

S-TB-40 40 mm Bore
1-1/4 Width **\$35.90**

Number	Bore	Width	Price
AM 92-008	1/2"	3/4"	\$11.05
AX 92-012	3/4"	1"	\$11.05
AP 92-008	1/2"	1-1/4"	\$11.05
AP 92-012	3/4"	1-1/4"	\$11.05
AP 92-016	1"	1-1/4"	\$11.05
AP 92-017	30mm	1-1/4"	\$11.05
AP 92-018	1-1/8"	1-1/4"	\$11.05

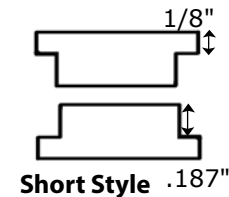

FREEBORN

Spacers and Shims

Spacers - Used in a wide range of woodworking applications.

These are expensive, but they are CNC precision lathe manufactured.

Spacers

Number	Bore	Width	Price
AM 94-002	3/4"	1/8"	\$20.40
AM 94-004	3/4"	1/4"	\$20.40
AM 94-006	3/4"	3/8"	\$20.40
AM 94-008	3/4"	1/2"	\$20.40
AM 94-010	3/4"	5/8"	\$20.40
AM 94-012	3/4"	3/4"	\$20.40
AM 94-016	3/4"	1"	\$20.40
AP 94-002	1-1/4"	1/8"	\$20.40
AP 94-004	1-1/4"	1/4"	\$20.40
AP 94-006	1-1/4"	3/8"	\$20.40
AP 94-008	1-1/4"	1/2"	\$20.40
AP 94-010	1-1/4"	5/8"	\$20.40
AP 94-012	1-1/4"	3/4"	\$20.40
AP 94-016	1-1/4"	1"	\$20.40

The Shaper Book By Lonnie Bird



With an emphasis on safety, this book is a step-by-step guide that will teach you all about the shaper: from basic setups to cutting curved molding profiles to designing shaper jigs that will expand your woodworking potential.

Shims - Sets of 48 color-coded plastic shims for various spacing needs.

Shims

Number	Bore	Price	Qty.	Color	Thickness	Qty.	Color	Thickness
AM 95-008	1/2"	\$49.30	6	Green	.003"	6	Black	.0125"
AM 95-012	3/4"	\$49.30	6	Blue	.005"	6	Pink	.015"
AP 95-016	1"	\$49.30	6	Matte	.0075"	6	Yellow	.020"
AP 95-018	1-1/8"	\$49.30	6	Brown	.010"	6	Coral	.030"
AP 95-020	1-1/4"	\$49.30						

Metal Shims

Part #	Bore	Price
C-470	1/2"	\$26.56
C471	3/4"	\$26.56
C472	1"	\$26.56
C473	1-1/8"	\$26.56
C474	1-1/4"	\$26.56

Each set contains 19 shims including one each of the following thickness: .001", .0015", .002", .003", .004", .005", .006", .007", .008", .010", .012", .015", .020", .025", .031", .047", .062", .093" and .125"

Shims - Sets of 20 metal shims in five thicknesses.

Metal Shims NEW





Number	Bore	Price	Qty.	Thickness
AM 95-012-M	3/4"	\$46.50	20	.003"(x4)
				.0005"(x4)
				.010"(x4)
				.015"(x4)
				.020"(x4)
AP 95-020-M	1-1/4"	\$46.50	20	.003"(x4)
				.0005"(x4)
				.010"(x4)
				.015"(x4)
				.020"(x4)

FREEBORN

"CO-ST" Cutters - Flute Cutters for use on Table Saws (4 Wing, 5/8" Bore)

All Cutters are 6-1/2" Diameter

Tilted 30° for continuous wood pull. Hand sand to break sharp edge.

3/4" Wide	5/8" Wide	1/2" Wide
		
35C	36C	37C
\$225.00	\$219.00	\$199.00
3/8" Wide	1/4" Wide	
		
37C-3/8	38C	
\$179.00	\$149.00	

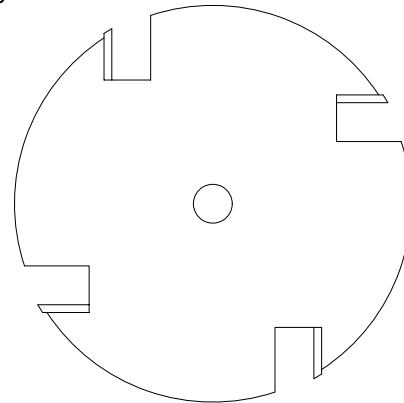

Setting Up a Lock Miter Set

This cutter makes a great joint in wood, but they can be a challenge to set up for a perfect fit. The reason is there are two factors that take place to ensure a proper fit. They are the cutter height and the fence position.

To begin the set-up, install the cutter onto the shaper so the middle height of the cutter and the middle height of the stock is approximately the same size vertically. It won't be perfect, but it is a good starting point. Using stock of the same thickness as you will in your project, run two pieces through horizontally, flip one piece 180 degrees and test fit them. If they are flush, your bit height is set correctly. If not, adjust the bit height by half of the distance that the fit was off. When you have got this step right, you can move on to adjusting the fence.

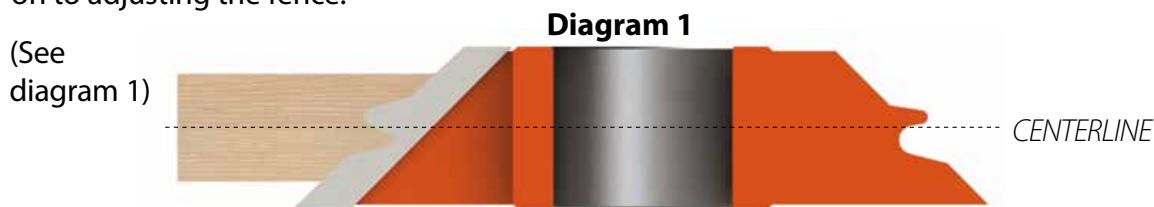

Start by running the test stock vertically against the face of the fence. Once the vertical pieces fit together flush, your set-up should be correctly set.

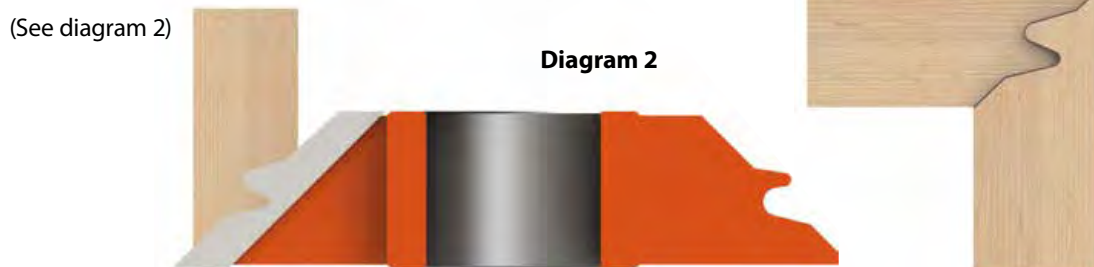

FREEBORN CLEARANCE - SIGNATURE SERIES

While Supplies Last

Although not as versatile as the Pro-Line and Mini-Pro series, you'll find the 2 wing Signature Series an exceptional value. Designed for 1/2" and 3/4" spindles, these carbide tipped shaper cutters were manufactured with the same precision you expect from Freeborn Tool Company. Many of our customers find them ideal for smaller jobs or hand-fed projects that require a high level of quality and exactness.

Straight Top Groovers

PART	IN STOCK	WIDTH	PRICE
SC-62-004	1	1/4	\$34.20
SC-62-006	2	3/8	\$36.00
SC-62-008	2	1/2	\$39.00
SC-62-012	2	3/4	\$43.20
SC-62-016	2	1	\$46.80
SC-62-024	1	1-1/2	\$55.20
SC-62-032	2	2	\$72.00

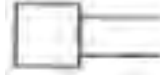

Signature Series: 2 wing, 2-15/16" diameter, 3/4" bore, Carbide-Tipped, designed to run with a 2-15/16" diameter run bearing (AM-90-047 \$40.50) for flush trim applications

Door Edge Detail Cutters

PART	IN STOCK	PRICE
SC-57-001	1	\$71.40

Door edge detail cutters have 1" wide tip.
Counterclockwise rotation with wood fed face up.

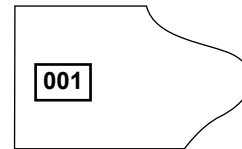

Signature Series: 2 wing, 2-15/16" diameter, 3/4" bore, Carbide-Tipped.

Rounding Cutters

HALF ROUND CONVEX				HALF ROUND CONCAVE				CORNER ROUNDING		
PART	WIDTH	RADIUS	PRICE	PART	OPENING	RADIUS	PRICE	PART	RADIUS	PRICE
SC-63-002**	1/4	1/8	\$39.00	SC-64-003**	3/8	3/16	\$54.00	SC-65-008**	1/2	\$82.20
SC-63-003**	3/8	3/16	\$42.60	SC-64-008*	1	1/2	\$97.80	SC-65-012**	3/4	\$94.80

*: One cutter remaining in stock
**: Two cutters remaining in stock



*: One cutter remaining in stock
**: Two cutters remaining in stock

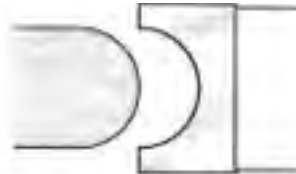

Half Round Concave Cutters have .030" flare for easy bull nosing.

*: One cutter remaining in stock
**: Two cutters remaining in stock



Rounding Cutters

Signature Series: 2 wing, 2-15/16" diameter, 3/4" bore, Carbide-Tipped

Reversible Glue Joint

PART	IN STOCK	PRICE
SC-58-001	1	\$94.80

Signature Series: 2 wing, 2-15/16" diameter, 3/4" bore, Carbide-Tipped

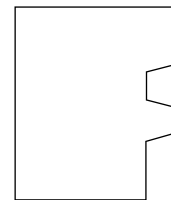

FREUD

Precision Shear Forstner Bits

PART	SIZE	PRICE
PB-001	1/4	\$6.97
PB-002	3/8	\$6.97
PB-003	1/2	\$8.02
PB-004	5/8	\$9.03
PB-005	3/4	\$10.05
PB-006	7/8	\$11.03
PB-007	1	\$13.02
PB-008	1-1/8	\$13.97
PB-009	1-1/4	\$14.98
PB-010	1-3/8	\$18.41
PB-011	1-1/2	\$22.47
PB-012	1-5/8	\$23.38
PB-013	1-3/4	\$25.17
PB-014	1-7/8	\$26.04
PB-015	2	\$28.35
PB-016	2-1/8	\$32.38
PB-107	7Pc Set Wooden Box	\$73.47
PB-107B	7Pc Set	\$63.98

Precision Shear High Speed Steel Forstner Bits feature a razor sharp serrated edge that slices throughout the rotation of the bit for less splintering and chipping, producing flawless flat-bottom holes.

Features Include: *Hardened Steel Body. Ultra Sharp Spur, Steep Angled Cutting Edges, Quality Forged Construction.*



Carbide-Tipped Precision Shear Forstner Bits

PART	SIZE	PRICE
FC-001	1/4	\$21.07
FC-002	3/8	\$21.07
FC-003	1/2	\$22.37
FC-004	5/8	\$23.94
FC-005	3/4	\$26.29
FC-006	7/8	\$28.49
FC-007	1	\$31.12
FC-008	1-1/8	\$32.83
PB-009	1-1/4	\$35.32
FC-010	1-3/8	\$36.68
FC-011	1-1/2	\$43.19
FC-012	1-5/8	\$46.13
FC-013	1-3/4	\$50.23
FC-014	1-7/8	\$55.09
FC-015	2	\$58.52
FC-016	2-1/8	\$67.45
FC-107	7Pc Set	\$179.06



FREUD



Safety Dado Sets SD300^{SERIES}

Features TiCo High Density Carbide Crosscutting Blend For Maximum Performance



Set Includes:

2 Blades, Shim Set, 5 Chippers

Caution: Carbide tips should never come into contact with each other. Always use both outside blades and never use chipper alone or with just one outside blade.

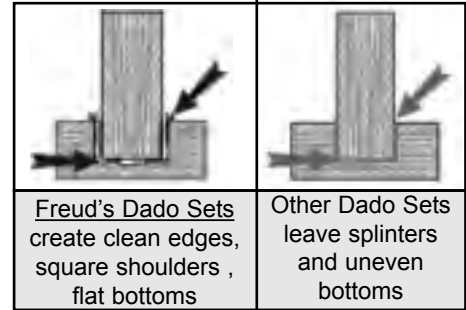

Freud's Dado Sets create clean edges, square shoulders, flat bottoms

Other Dado Sets leave splinters and uneven bottoms

Slot Width	Chippers Required	
	1/8"	3/32"
1/4"	0	0
5/16"	0	1
3/8"	1	0
7/16"	1	1
1/2"	2	0
9/16"	2	1
5/8"	3	0
11/16"	3	1
3/4"	4	0
13/16"	4	1

PART	DIA.	TEETH	ARBOR	CHIPPERS	PRICE
SD306	6	18	5/8	(4)1/8, (1)1/16	\$159.78
SD308	8	22	5/8	(4)1/8, (1)1/16	\$170.70

Pro Dado Sets SD200^{SERIES}

Features TiCo High Density Carbide Crosscutting Blend For Maximum Performance



Set Includes:

2 Blades, Shim Set, 5 Chippers

Caution: Carbide tips should never come into contact with each other. Always use both outside blades and never use chipper alone or with just one outside blade.

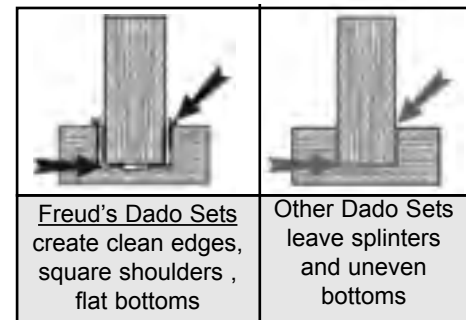

Freud's Dado Sets create clean edges, square shoulders, flat bottoms

Other Dado Sets leave splinters and uneven bottoms

Slot Width	Chippers Required	
	1/8"	3/32"
1/4"	0	0
5/16"	0	1
3/8"	1	0
7/16"	1	1
1/2"	2	0
9/16"	2	1
5/8"	3	0
11/16"	3	1
3/4"	4	0
13/16"	4	1

PART	DIA.	TEETH	ARBOR	CHIPPERS	PRICE
SD206	6	10	5/8	(4)1/8, (1)1/16	\$98.46
SD208	8	12	5/8	(4)1/8, (1)1/16	\$110.46

FREUD

Slot Width	of Chippers Required		
	1/8"	3/32"	
1/4"	0	0	0
5/16"	0	0	1
11/32"	0	1	0
3/8"	1	0	0
13/32"	0	1	1
7/16"	1	0	1
15/32"	1	1	0
1/2"	2	0	0
17/32"	1	1	1
9/16"	2	0	1
19/32"	2	1	0
5/8"	3	0	0
21/32"	2	1	1
11/16"	3	0	1
23/32"	3	1	0
3/4"	4	0	0
25/32"	3	1	1
13/16"	4	0	1
29/32"	4	1	1



Super Dado Sets SD500^{SERIES}

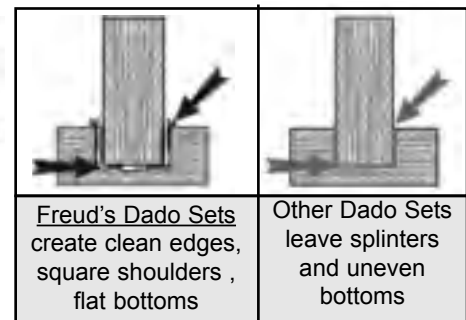

Freud's Dado Sets create clean edges, square shoulders, flat bottoms

Other Dado Sets leave splinters and uneven bottoms

Set Includes:
2 Blades, Shim Set, 5 Chippers

Caution: Carbide tips should never come into contact with each other. Always use both outside blades and never use chipper alone or with just one outside blade.

PART	DIA.	TEETH	ARBOR	CHIPPERS	PRICE
SD506	6	20	5/8	(4)1/8, (1)3/32, (1)1/16	\$208.50
SD508	8	24	5/8	(4)1/8, (1)3/32, (1)1/16	\$236.25



Set creates perfect 1/4", 3/8" Box Joints

BoxJoint Cutter Set SBOX8 Series

Features TiCo High Density Carbide Crosscutting Blend For Maximum Performance

PART	DIA.	TEETH	ARBOR	HOOK ANGLE	WIDTH OF CUT	PRICE
SBOX8	8	20	5/8	20°	1/4 Groove,	\$90.34

Set Includes: 2 Blades



Caution: Carbide tips should never come into contact with each other. Always use both outside blades

How It Works:

The set is easy to use. Simply install the two 8" diameter, 5/8" arbor blades on a table saw with the blades back to back for 1/4" box joints (A), or face to face for 3/8" box joints (B)

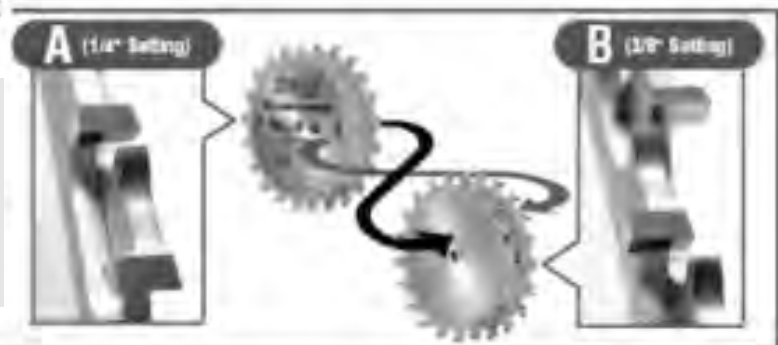

FREUD PLANER , JOINTER KNIVES

High Speed Industrial
Planer, Joiner Knives

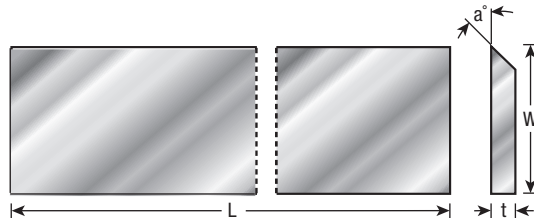

PART	L	W	H	QTY	FOR	PRICE
C310	4	5/8	1/8	3	--	\$17.12
C320	4	7/8	1/8	3	--	\$17.12
C330	4-3/8	11/16	1/8	3	--	\$19.53
C350	6	5/8	1/8	3	--	\$26.29
C351	6	5/8	1/8	4	--	\$34.44
C360	6	7/8	1/8	3	--	\$27.34
C370	6	1	1/8	2	--	\$20.69
C390	6-1/16	3/4	1/8	3	--	\$27.34
C400	6-1/8	11/16	1/8	3	--	\$27.34
C410	6-1/8	3/4	1/8	3	--	\$27.34
C420	6-1/2	1	1/8	3	--	\$28.49
C430	8	5/8	1/16	4	--	\$46.59
C440	8	5/8	1/8	4	--	\$46.59
C441	8	5/8	1/8	3	--	\$34.44
C460	8	3/4	1/8	3	--	\$33.44
C470	8	7/8	1/8	3	--	\$34.44
C480	8	1	1/8	3	--	\$34.44
C490	8-1/16	5/8	3/32	3	--	\$34.44
C491	8-1/16	5/8	3/32	4	--	\$46.59
C500	8-1/4	1-1/4	1/8	3	--	\$36.19
C600	10	1-3/8	1/8	2	Ryobi AP10	\$38.33
C510	12	5/8	1/8	3	--	\$50.44
C520	12	3/4	1/8	3	--	\$50.44
C010	12	7/8	1/8	1	--	\$17.12
C540	12	1	1/8	3	--	\$50.44
C550	12-1/4	5/8	1/8	3	--	\$53.13
C560	12-1/4	3/4	1/8	3	--	\$53.13
C570	12-1/4	1	1/8	3	--	\$53.13
C610	12-1/2	35MM	1/8	2	Makita 030N	\$49.25

PART	L	W	H	QTY	FOR	PRICE
C573	12-1/2	11/16	1/8	3	Foley/Bellsaw	\$53.13
C012	12	7/8	1/8	3	--	\$53.13
C020	12-1/2	15/16	1/8	1	--	\$18.27
C630	13-1/8	1	1/8	3	Delta RC33	\$74.03
C030	13-1/8	11/16	5/32	1	--	\$23.52
C045	15	1	1/8	3	--	\$63.91
C620	15-5/8	35mm	1/8	2	Makita 2040	\$60.27
C035	18	1-1/8	5/32	1	--	\$29.54
C593	18-1/2	11/16	1/8	3	--	\$78.47
C040	19	11/16	1/8	1	--	\$27.34
C050	20	1	1/8	1	--	\$28.49
C052	20	1-3/16	1/8	4	--	\$119.00
C055	20-1/2	11/16	1/8	3	--	\$85.37
C060	24	1-1/8	5/32	1	--	\$44.38
C070	24	1-1/2	5/32	1	--	\$53.13
C090	25	5/8	3/32	1	--	\$38.33
C100	25	5/8	1/8	1	--	\$38.33
C110	25	3/4	1/8	1	--	\$36.19
C120	25	1-1/4	1/8	1	--	\$37.27
C130	25	1-1/4	5/32	1	--	\$45.54
C583	25	11/16	1/8	3	--	\$112.98
C140	30	1-1/2	1/8	1	--	\$60.27
C150	37	1-1/8	1/8	1	--	\$58.66
C160	37	1-3/8	1/8	1	--	\$67.38
C170	37	1-3/8	5/32	1	--	\$84.95
C180	37	1-1/4	5/32	1	--	\$75.08
C190	37	1-1/2	5/32	1	--	\$89.39
C200	37	2	5/32	1	--	\$111.83

Solid Carbide Knives

PART	L	W	T	PRICE
BS458	4	5/8	1/8	\$19.00 /each
BS658	6	5/8	1/8	\$31.00 /each
BS634	6	3/4	1/4	\$35.00 /each
BS61	6	1	1/8	\$47.00 /each
BS56114	6	1-1/4	5/32	\$74.00 /each
BS858	8	5/8	1/8	\$42.00 /each
BS834	8	3/4	1/8	\$47.00 /each
BS878	8	7/8	1/8	\$55.00 /each
BS81	8	1	1/8	\$64.00 /each
BS58114	8	1-1/4	5/32	\$88.62 /each
BS1258	12	5/8	1/8	\$98.00 /each
BS1211	12	11/16	1/8	\$98.00 /each
BS1278	12	3/4	1/8	\$98.00 /each
BS121	12	7/8	1/8	\$98.00 /each
BS1278	12	1	1/8	\$98.00 /each
BS12	12-1/2	5/8	1/8	\$98.00 /each
BS1212	12-1/2	11/16	1/8	\$98.00 /each
BS129	12-1/2	3/4	1/8	\$98.00 /each
BS1214	12-1/2	7/8	1/8	\$98.00 /each
BS131	13-1/8	1	1/8	\$120.00 /each

FREUD

Double Flute



ROUTER BITS

DoubleFlute Straight Bits - Metric Version

PART	(D) OVERALL DIA.	(R) CARBIDE HEIGHT	(A) SHANK DIA.	(H) OVERALL LENGTH	PRICE
04-502*	2mm	5/32	1/4	1-1/2	\$12.85
04-508*	3mm	5/16	1/4	1-3/4	\$13.09
04-512*	5mm	1-5/32	1/4	2	\$13.41
04-520	10mm	1-1/4	1/4	2-3/8	\$19.92
04-524	12mm	3/4	1/4	2-1/64	\$19.46
04-528	12mm	1-1/4	1/4	2-3/8	\$19.92
04-532	15mm	3/4	1/4	2-1/4	\$19.60
04-536	15mm	1-1/4	1/4	2-5/8	\$23.17
04-540	16mm	3/4	1/4	2-1/4	\$19.74
04-544	16mm	1-1/4	1/4	2-5/8	\$23.24
04-548	18mm	3/4	1/4	2	\$19.92
04-552	20mm	3/4	1/4	2	\$22.33
12-520	10mm	1-1/4	1/2	2-3/4	\$21.04
12-530	12mm	1-1/4	1/2	2-3/4	\$22.33
12-544	16mm	1-1/4	1/2	2-3/4	\$23.38

*: Solid Carbide

Brick Molding Bit

PART	PROFILE DESIGN	OVERALL DIA. (D)	CARBIDE HEIGHT (h)	SHANK DIA. (A)	OVERALL LENGTH (H)	PRICE
99-460	Brick Molding 1180	3-1/2	1/2	1/2	3	\$92..26

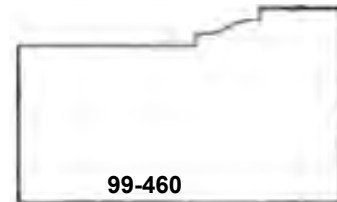

Below are bits that we have in stock and on special sale.

PART #	PRICE	PART #	PRICE	PART #	PRICE	PART #	PRICE
42-106	\$15.30	98-505	\$131.22	99-020	\$40.85	99-218	\$35.00
42-118	\$21.04	98-507	\$131.22	99-021	\$71.72	99-286	\$159.95
54-760	\$35.74	98-509	\$131.22	99-022	\$72.63	99-290	\$99.19
89-102	\$129.58	98-514	\$131.22	99-023	\$49.00	99-291	\$99.19
89-152	\$137.66	99-001	\$64.47	99-024	\$49.00	99-293	\$99.19
90-100	\$260.58	99-002	\$47.39	99-025	\$48.48	99-315	\$53.94
91-104	\$159.67	99-003	\$36.96	99-026	\$34.58	99-318	\$55.41
91-108	\$192.85	99-004	\$40.57	99-028	\$78.37	99-320	\$53.94
93-200	\$396.59	99-005	\$39.94	99-029	\$39.90	99-322	\$53.94
96-100	\$119.98	99-006	\$57.65	99-030	\$46.76	99-482	\$58.21
98-307	\$257.29	99-007	\$68.81	99-041	\$64.96	99-484	\$44.56
98-308	\$257.29	99-008	\$67.87	99-044	\$83.50	98-327	\$66.36
98-309	\$257.29	99-009	\$56.95	99-060	\$53.44	98-328	\$66.36
98-317	\$327.67	99-010	\$59.82	99-061	\$52.43	98-329	\$66.36
98-318	\$327.67	99-011	\$59.82	99-062	\$54.11	BC38MAA-9	\$14.56
98-319	\$327.67	99-019	\$40.88	99-214	\$70.63		

FREUD *Drawings Shown to Scale*

Casing Bits

PART	PROFILE DESIGN	(D)	(h)	(A)	(H)	PRICE
99-465	Casing #356	1-5/8	2-1/2	1/2	4	\$75.29
99-466	Casing #366	1-1/2	1-13/16	1/2	3-9/32	\$58.21
99-467	Casing #376	1-5/8	1-15/16	1/2	3-7/16	\$67.17
99-468	Casing #445	1-1/2	2-7/8	1/2	4-3/8	\$72.91

Base, Cap Bits

PART	PROFILE DESIGN	(D)	(h)	(A)	(H)	PRICE
99-480	Base Cap 1163	1-3/4	1-1/2	1/2	3	\$58.21
99-482	Base Cap 1166	1-11/16	1-1/2	1/2	2-7/8	\$58.21
99-484	Base Molding*	1-11/16	15/32	1/2	2-3/8	\$44.56

Chair Rail Bits

PART	PROFILE DESIGN	(D)	(h)	(A)	(H)	PRICE
99-475	Chair Rail #390	1-11/16	2-3/4	1/2	1-1/4	\$87.75
99-477	Chair #300, upper	2-1/4	1-1/2	1/2	3	\$56.63
99-478	Chair #300, lower	2-3/16	1-13/16	1/2	3-5/16	\$62.30

Beadboard Bit System

PART	DESCRIPTION	(D)	(h)	(A)	(H)	RADIUS (R)	PRICE
20-301	Radius 'V' Groove Bit	1/4	3/16	1/4	1-3/4	1/8	\$16.14
99-472	Beadboard Groove Bit	1-7/8	13/16	1/2	2-7/8	1/8	\$90.69

Table Edge, Handrail Bits

PART	(D)	BEARING Dia. (B)	(h)	LARGE Rad. (R1)	SMALL Rad. (R2)	(A)	(H)	PRICE
99-027	2-19/32	1/2	23/32	1-25/32	13/64	1/2	2-5/8	\$88.27
99-450	2-1/2	1/2	25/32	3/8	15/64	1/2	2-3/4	\$77.98
99-452	2-5/8	1/2	25/32	1-3/32	11/64	1/2	2-3/4	\$91.32

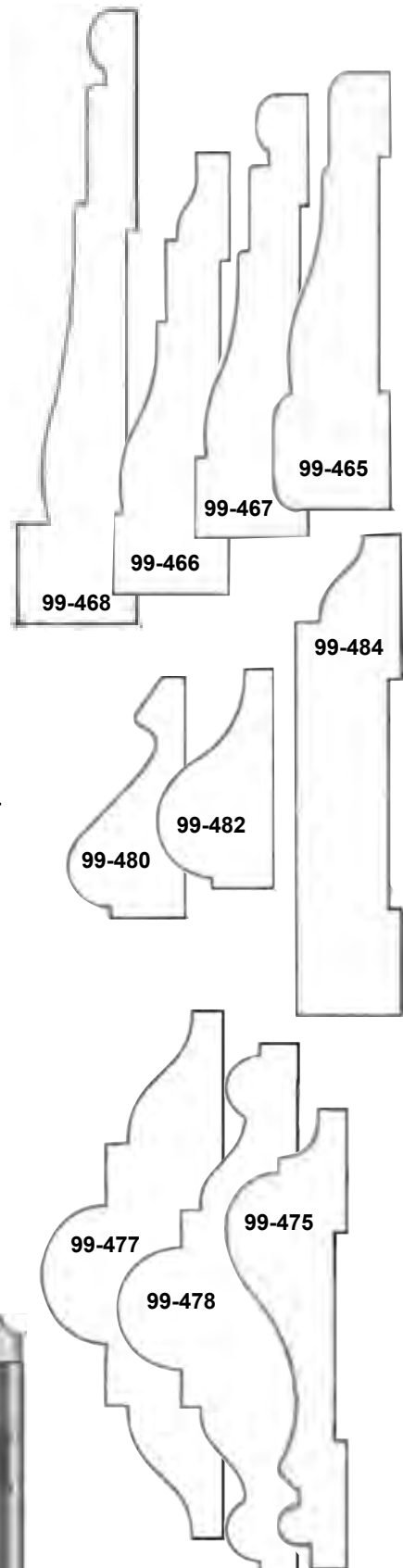
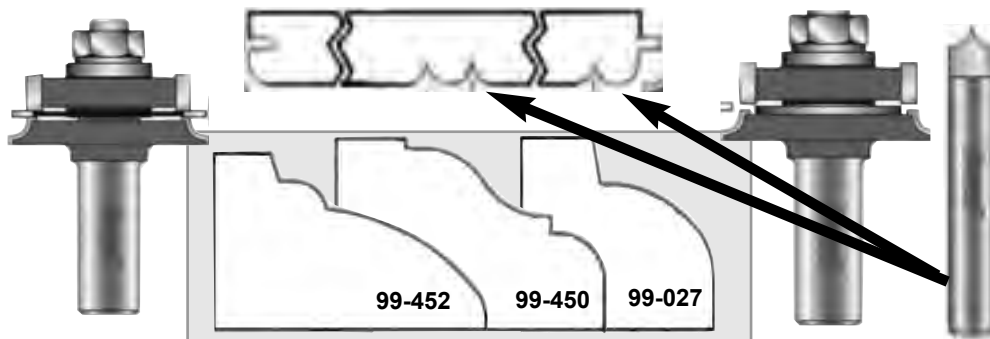

FREUD

One bit produces countless designs for face, corner and crown molding.

Multi-Profile Bits

PART	OVERALL DIA. (D)	SMALL DIA. (n)	CARBIDE HEIGHT (h)	MINOR HEIGHT (m)	(R1) RADIUS	(R2) RADIUS	(R3) RADIUS	SHANK DIA. (A)	OVERALL LENGTH (H)	PRICE
99-PK1	2-5/32	-	1-59/64	-	25/64	5/16	15/64	1/2	4	\$76.51
99-PK2	1-1/4	1-3/32	51/64	5/64	3/8	5/64	-	1/2	2-1/4	\$41.58
99-PK3	1-1/4	1-3/32	29/32	5/64	3/8	5/64	-	1/2	2-7/16	\$41.58
99-PK7	2-33/64	1-7/32	1-51/64	3/32	1/4	3/16	-	1/2	3-1/2	\$108.15
99-PKJ	1-1/2	-	1-7/64	-	7/32	3/16	1/8	1/2	3	\$61.81

Handrail Bits

PART	BEARING (D)	BEARING Dia. (B)	(h)	LARGE Rad. (R1)	SMALL Rad. (R2)	(A)	(H)	PRICE
99-442	1-3/16	5/8	1-1/2	1	3/8	1/2	3-1/2	\$62.51
99-444	1-3/16	5/8	1-1/2	1/2	3/8	1/2	3-1/2	\$62.51
99-446	1-3/8	1/2	1-1/2	1/8	-	1/2	3-1/4	\$73.01

Face Molding Bits

PART	(D)	(B)	MINOR HEIGHT (h)	(m)	(R1)	(R2)	(A)	(H)	PRICE
99-012	15/16	1/2	1-3/8	3/32	25/32	9/64	1/2	3-1/4	\$70.07
99-013	15/16	1/2	1-3/8	5/32	21/64	9/64	1/2	3-1/4	\$48.23
99-014	15/16	1/2	1-1/2	11/64	25/32	5/32	1/2	3-3/8	\$70.07
99-015	1-1/16	1/2	1-5/8	5/64	5/16	1/8	1/2	3-1/2	\$49.98
99-016	1	1/2	7/8	1/8	45/64	1/8	1/2	2-3/4	\$52.26

Reversible Wainscoting Bit

PART	(D)	(B)	MINOR HEIGHT (h)	(m)	(R)	(A)	(H)	PRICE
99-470	1-1/2	1/2	7/16	3/16	1/4	1/2	2-1/4	\$36.93

New Wide Crown Molding System

PART	PROFILE	(D)	(h)	(A)	(H)	PRICE
99-414	Upper 1	1-5/16	3	1/2	4-7/16	\$72.07
99-415	Lower 2	1-3/8	3-1/16	1/2	4-9/16	\$72.07
99-416	Upper 3	1-13/32	3	1/2	4-7/16	\$72.07
99-417	Lower 4	1-3/8	3-1/16	1/2	4-9/16	\$72.07
99-418	Upper 5	1-1/4	3	1/2	4-7/16	\$72.07
99-419	Lower 6	1-3/8	3-1/16	1/2	4-9/16	\$72.07
99-421	Bevel Cutter	2-3/8	1-3/8	1/2	2-13/16	\$72.07

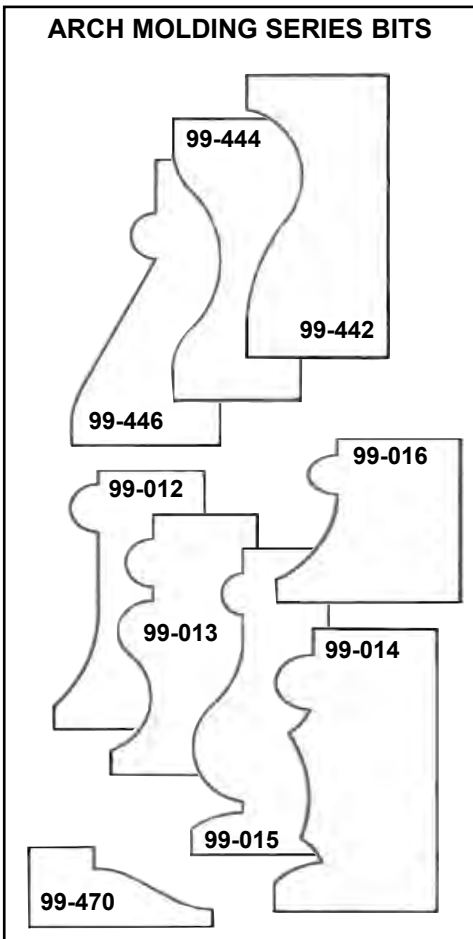

Wide Crown Molding Sets

PART	PROFILE	PRICE
98-505	99-414 & 99-415	\$131.22
98-507	99-414 & 99-417	\$131.22
98-509	99-415 & 99-416	\$131.22
98-514	99-417 & 99-418	\$131.22

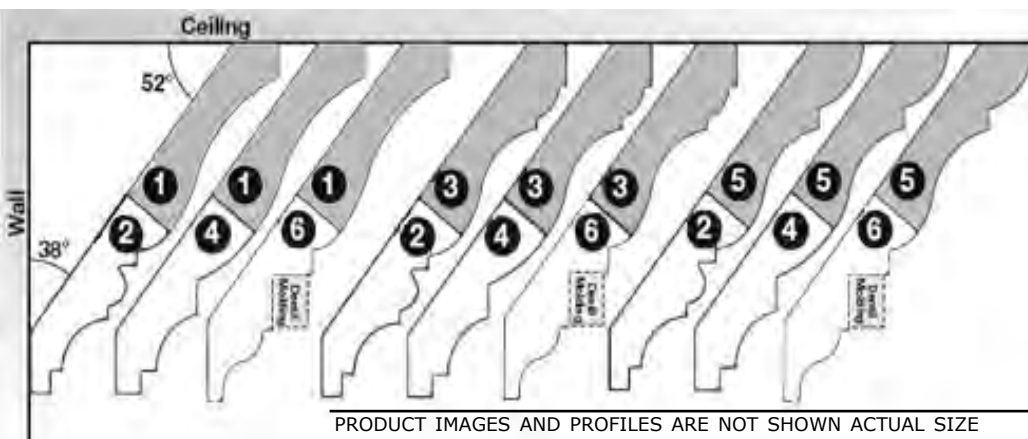

FREUD Crown Molding Bits

PART	(D)	(h)	(R1)	(R2)	(d)	(A)	(H)	PRICE
99-402	1-1/4	2-1/4	17/32	7/32	45°	1/2	3-3/4	\$61.81
99-404	1-1/4	2-1/4	43/64	15/32	45°	1/2	3-3/4	\$61.81
99-406	1-1/4	2-1/4	25/64	-	45°	1/2	3-3/4	\$61.81
99-408	1-1/4	2-1/4	1-1/4	-	45°	1/2	3-3/4	\$61.81
99-410	1-1/4	2-1/4	3/16	1/8	10°	1/2	3-3/4	\$61.81

Canoe Joint Bits

PART	(D)	(h)	(R)	(A)	(H)	PRICE
99-017	1-1/2	1/4	1/8	1/2	1-11/16	\$53.73
99-018	1-1/2	3/8	1/8	1/2	1-7/8	\$48.16

Reversible Glue Joint Bit

PART	(D)	(h)	(R)	(d)	(A)	(H)	PRICE
99-031	1-1/2	1-3/16	1-1/4	30°	1/2	2-3/4	\$71.47

Drawer Lock Bits

PART	(D)	(n)	(h)	(m)	(d)	(A)	(H)	PRICE
99-239	1-1/4	1-1/64	1/2	13/64	30°	1/4	1-3/4	\$36.33
99-240	2	1-3/4	33/64	5/32	30°	1/2		\$38.22

Lock Miter Bits

PART	(D)	(h)	(d)	(A)	(H)	PRICE
99-034	2-3/4	1-5/32	45°	1/2	2-5/8	\$95.41
99-035	2-11/64	7/8	45°	1/2	2-3/8	\$83.90
99-043	1-15/32	7/8	22-1/2°	1/2	2-3/8	\$99.19

Wedge Tongue, Groove Bits

PART	(D)	(n)	(h)	(m)	(d)	(A)	(H)	PRICE
99-032	1-1/4	1-1/64	1/2	13/64	30°	1/4	1-3/4	\$69.90
99-033	2	1-3/4	33/64	5/32	30°	1/2	2	\$61.18

Adjustable Tongue, Groove Bit Set

PART	BIT TYPE	(D)	(B)	(h)	(A)	(H)	PRICE
99-036	Tongue Bit	1-3/4	7/8	1-3/16 - 1-11/32	1/2	3-1/4	\$80.01
	Groove Bit	1-3/4	7/8	7/32 - 3/8	1/2	2-11/16	

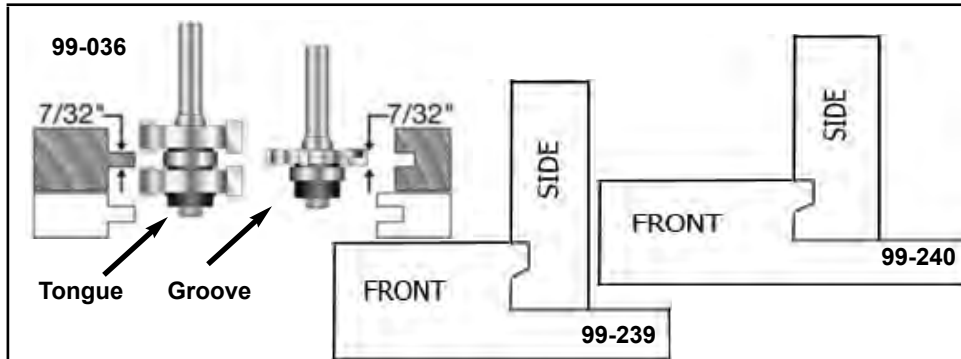

ARCH MOLDING SERIES BITS

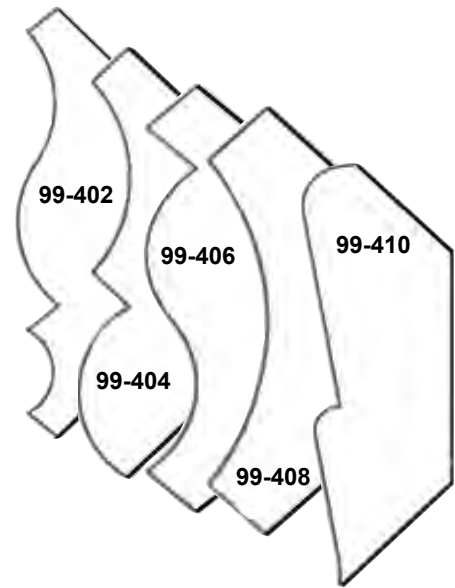

JOINERY BITS

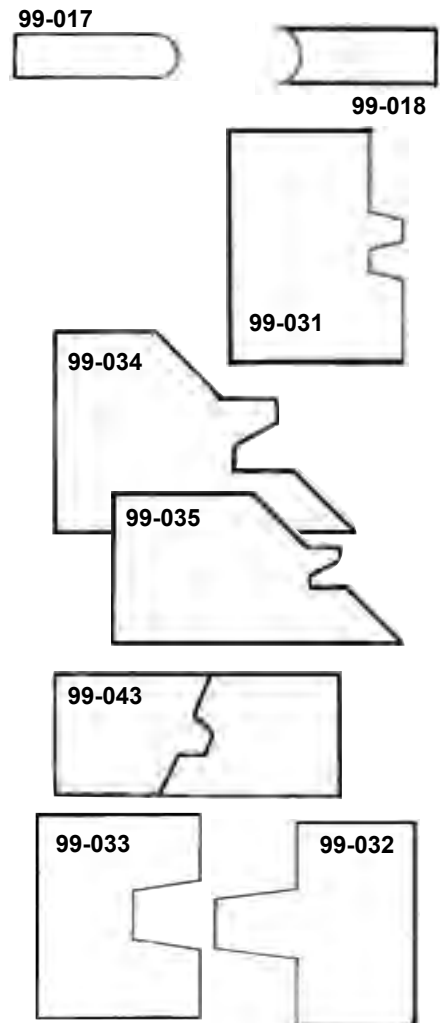

FREUD

JOINERY BITS

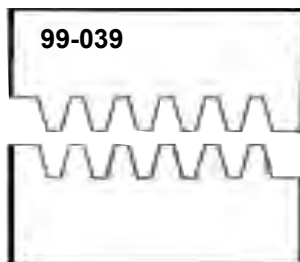
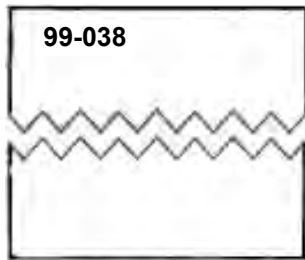

DOOR , WINDOW BITS

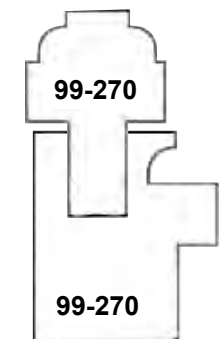
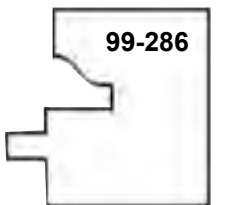
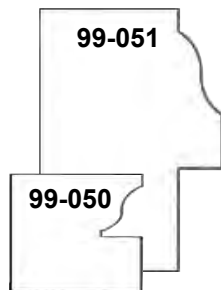
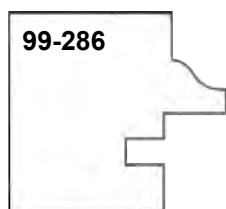

Raised Panel "V" Joint Bit

PART	(D)	(h)	(m)	(d)	(A)	(H)	PRICE
99-038	1-3/8	1-37/64	3/16	80°	1/2	3-1/16	\$93.35

Finger Joint Bit

PART	(D)	CUT DEPTH (C)	(h)	(m)	(A)	(H)	PRICE
99-037	1-3/8	5/16	1-9/16	21/64	1/2	3	\$108.29

Variable Height Finger Joint Bit

PART	(D)	CUT Dia.	(B)	(h)	(A)	(H)	PRICE
99-039	2	5/16	1-3/8 (35mm)	1-9/16	1/2	4-1/4	\$163.49

Replacement Cutters				
ITEM	(D)	BORE Dia.	(h)	PRICE
52-104	2	5/16	7/32	\$20.34
52-108	2	5/16	21/64	\$26.71

"V" Panel Bit Set

PART	(D)	(n)	(h)	MINOR HEIGHT		(d)	(A)	(H)	PRICE
				(m1)	(m2)				
99-191	1-11/64	1-37/64	1-1/8	5/32-5/16	25/64	45°	1/2	3-3/8	\$172.48

Window Sash , Rail Bits

PART	(D)	(B)	(h)	(R1)	(R2)	(A)	(H)	PRICE
99-050	1-1/2	-	39/64	1/16	1/4	1/2	2-1/16	\$50.54
99-051	1-11/32	22mm	1-25/64	17/32	1/4	1/2	3-7/16	\$84.18

Glass Panel Cabinet Door Bit Set

PART	(D)	(B)	(h)	(R1)	(R2)	(A)	(H)	PRICE
99-286	2	16mm	1-3/32	7/32	11/32	1/2	3-1/8	\$159.95

Glass Panel Molding Spine			
ITEM	Color	Roll Length	PRICE
GM005	Fruitwood (medium brown)	25'	\$15.44

Divided Lite Cabinet Door Bit Set

PART	(D)	(B)	(n)	(h)	(R)	(A)	(H)	PRICE
99-270	1-17/32	22mm	1-1/4	1-1/8	1/8	1/2	3-7/16	\$135.31

No Lip Door Edge Bit

PART	(D)	(h)	(R1)	(R2)	(A)	(H)	PRICE
99-063	1-3/4	5/8	9/32	5/64	1/2	2-5/8	\$53.45

FREUD

Recoverable Bead Glass Door Bit Sets

PART	(D)	(B)	(h)	(m)	(R)	(A)	(H)	PRICE
99-280	2-3/8	1-1/4	7/8	1/8	7/32	1/2	3	\$141.05
99-281	2-3/8	1-1/4	7/8	1/8	7/32	1/2	3	\$141.05
99-283	2-3/8	1-1/4	7/8	1/8	15/64	1/2	3	\$141.05

Entry, Interior Door Router System

PART	(D)	(n)	(h)	(m)	(R)	(A)	(H)	PRICE
99-267	1-11/16	1-5/16	11/16	15/64	7/32	1/2	3	\$224.25
99-268	1-11/16	1-19/32	23/32	15/64	13/64	1/2	3	\$224.25
99-269	1-11/16	1-19/32	3/4	15/64	9/32	1/2	3	\$224.25

Entry , Interior Door Bit Set

99-277	1-9/32	25/32	13/16	-	-	1/2	2-11/16	\$271.22
--------	--------	-------	-------	---	---	-----	---------	----------

2+2 Raised Panel Bits

PART	(D)	(n)	(h)	(m)	(R1)	(R2)	(A)	(H)	PRICE
99-510	2-3/4	-	5/8	7/32	35/64	1/8	1/2	2-1/2	\$90.93
99-511	2-3/4	1-1/8	5/8	15/64	-	-	1/2	2-1/2	\$90.93
99-512	2-3/4	1-1/4	5/8	17/64	13/64	-	1/2	2-1/2	\$90.93
99-513*	2-3/4	-	5/8	15/64	7/16	-	1/2	2-1/2	\$90.93
99-515	3-1/2	1-1/4	5/8	5/32	-	-	1/2	2-1/2	\$93.59
99-516	3-1/2	1-1/4	1/2	5/32	-	-	1/2	2-1/2	\$97.62
99-518	3-1/2	-	5/8	5/64	1-1/2	-	1/2	2-1/2	\$93.59
99-519	3-1/2	-	1/2	5/64	1-1/2	-	1/2	2-1/2	\$112.32
99-520	3-1/2	-	5/8	7/32	25/32	5/32	1/2	2-1/2	\$93.59
99-521	3-1/2	-	1/2	-	1-3/16	5/32	1/2	2-1/2	\$84.21
99-522	3-1/2	1-1/4	5/8	-	15/64	-	1/2	2-1/2	\$90.93
99-523	3-1/2	1-1/4	1/2	-	5/32	-	1/2	2-1/2	\$84.21

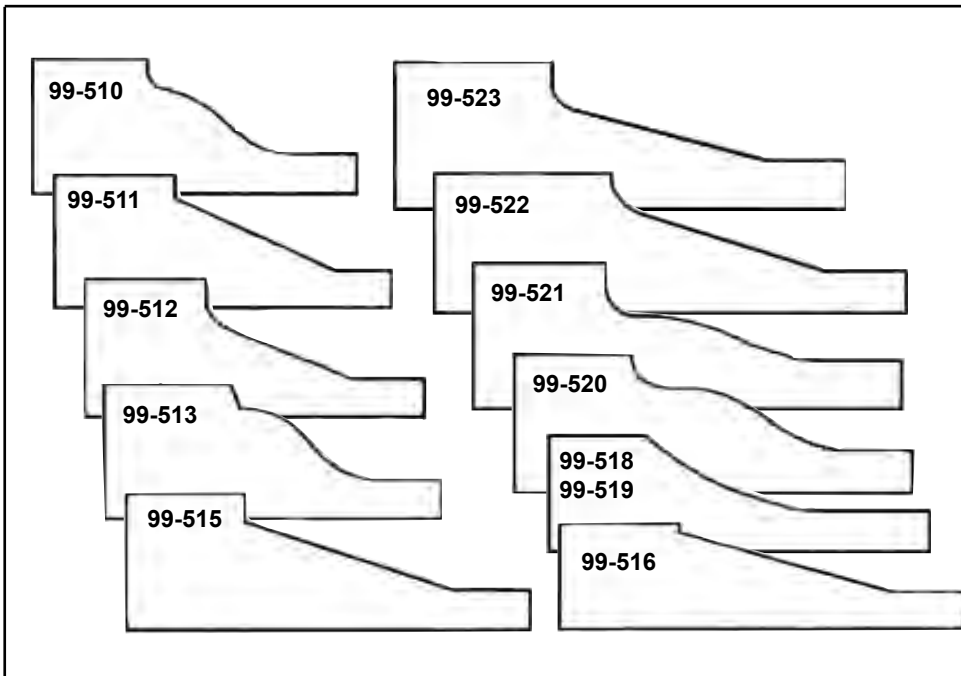

DOOR , WINDOW BITS

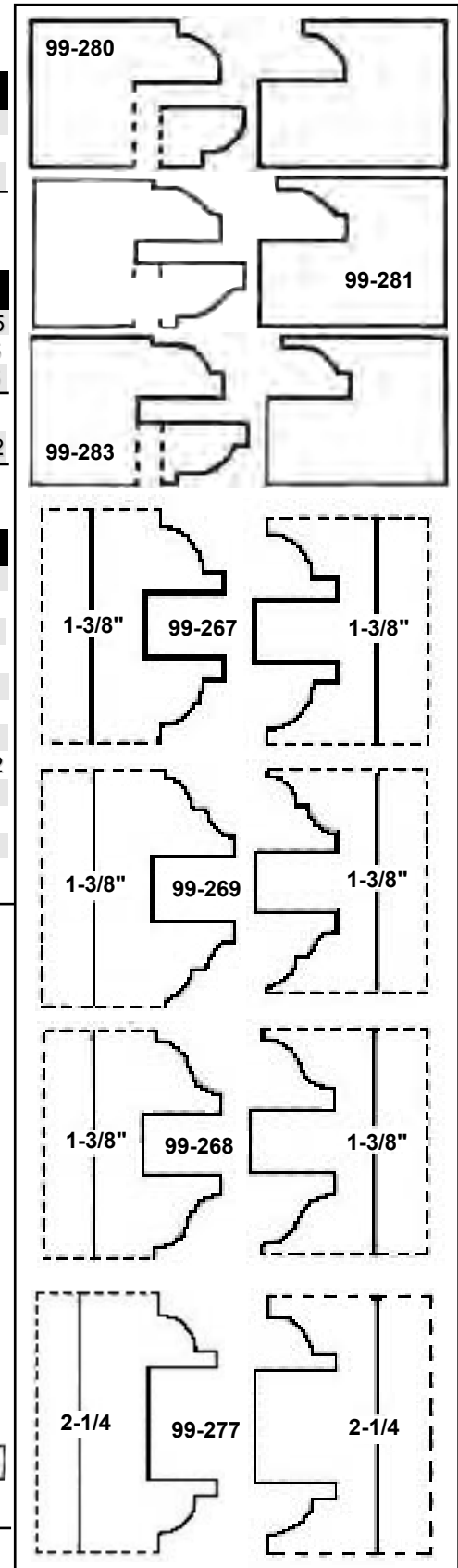

FREUD

2+2 Raised Panel Bits with Backcutters

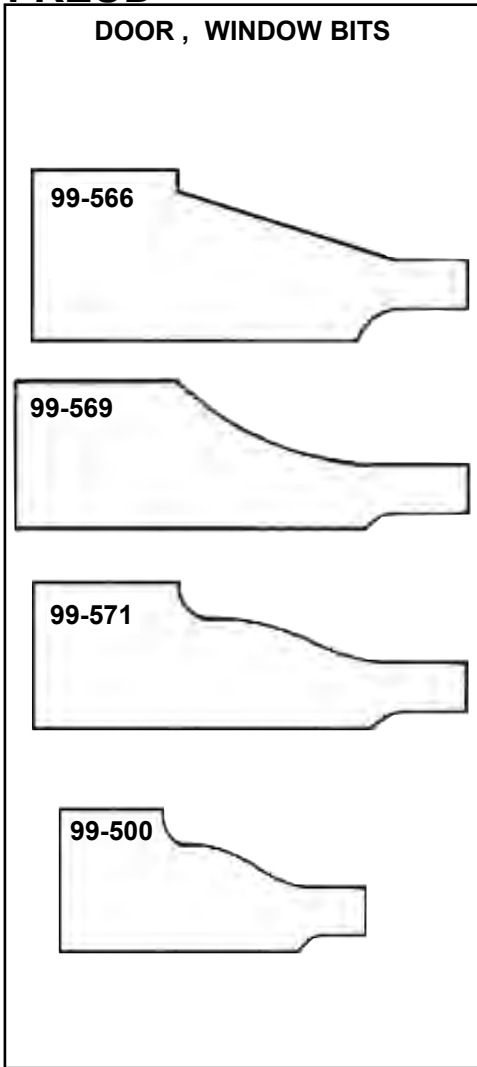

PART	(D)	(h)	(m)	(R1)	(R2)	(A)	(H)	PRICE
99-500	2-19/32	7/8	-	3/4	7/64	1/2	2-51/64	\$112.67
99-566	3-1/2	1	5/32	-	3/16	1/2	3	\$119.56
99-569	3-1/2	1	5/32	1-1/2	3/16	1/2	3	\$119.56
99-571	3-1/2	1	-	1-3/16	5/32	1/2	3	\$119.56

Finger Pull Door Lip Bit

PART	(D)	(n)	(h)	(R1)	(R2)	(d)	(A)	(H)	PRICE
99-064	1-3/4	5/8	1-3/16	9/32	3/32	-	1/2	2-5/8	\$51.77
99-065	2	3/4	1-1/4	1/4	-	25°	1/2	2-3/4	\$65.84

Drawer Front Bit

PART	(D)	(h)	(R)	(A)	(H)	PRICE
99-066	2	9/16	29/32	1/2	2-3/8	\$37.00

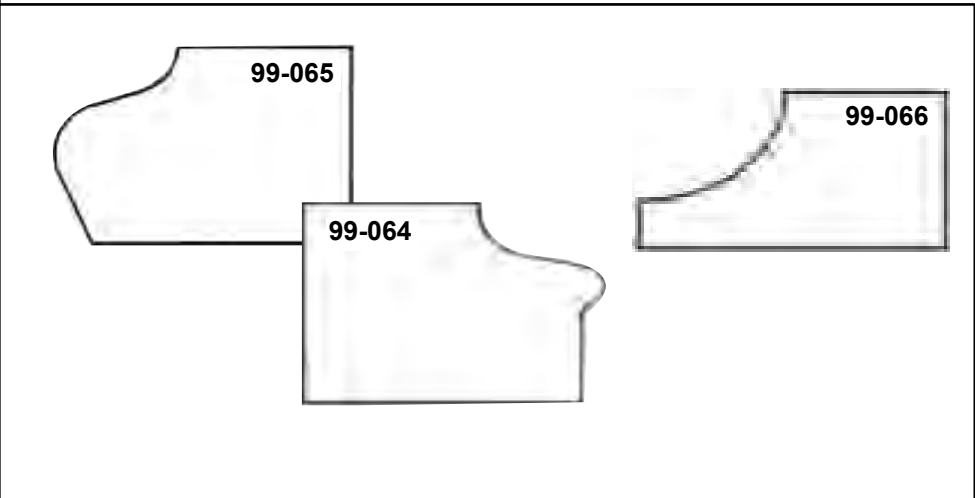

91-100

ROUTER BIT SETS 13 Piece Super Bit Set

BIT TYPE	PRICE
13 Piece Set Item 1 91-100 includes:	
Double Flute Straight Bit (12-100)	
Double Flute Straight Bit (12-116)	
Double Flute Straight Bit (12-152)	
Mortising Bit (16-110)	
Round Nose Bit (18-114)	
"V" Grooving Bit (20-108)	
Dovetail Bit (22-112)	
Cove Bit (30-114)	
Rabbeting Bit (32-102)	
Rounding Over Bit (34-124)	
Roman Ogee Bit (38-106)	
Chamfer Bit (40-114)	
Bearing Flush Trim Bit (42-110)	
All parts above are 1/2" shank	\$260.58

FREUD

ROUTER BIT SETS

3 Piece Door Construction Set

PART	BIT TYPE	PRICE
98-300	Roundover (99-267) Quadra-Cut™ Panel Bit (99-515)	\$312.66
98-302	Roundover (99-267) Quadra-Cut™ Panel Bit (99-518)	\$312.66

5 Piece Cabinet, Molding Bit Sets

PART	BIT TYPE	PRICE
95-100	Reversible Glue Joint Bit (99-031) Quadra-Cut™ Panel Bit (99-510) Multi-Profile Bit (99-PK1) Rail , Stile Bit Set	\$396.59

New Architectural Molding Set

PART	BIT TYPE	PRICE
93-200	Base Cap 1163 (99-480) Casing 1366 (99-466) Crown Bit, upper profile 11 (99-414) Crown Bit, lower profile 14 (99-417) Chair Rail 1300, upper bit (99-477) Chair Rail 1300, lower bit (99-478)	\$396.59

Advanced Cabinet Door Sets

PART	BIT TYPE	PRICE
95-200	Reversible Glue Joint Bit (99-031) Quadra-Cut™ Panel Bit (99-510) Drawer Lock Bit (99-240) Rail , Stile Bit Set	\$283.19



All Router Bit Sets listed in this section are packaged in an attractive wooden storage box with plastic covering and a template diagram on the front.

BALL BEARING REPLACEMENTS for ROUTER BIT SETS

Ball Bearings

PART	INSIDE DIA.	BEARING DIA.	BEARING HEIGHT	PRICE
62-100	1/8	3/8	5/32	\$5.29
62-102	3/16	3/8	1/8	\$6.41
62-103	1/4	1/2	3/16	\$6.41
62-104	3/16	1/2	3/16	\$5.08
62-105	10mm	9mm	7mm	\$9.80
62-106	1/4	3/4	9/32	\$6.41
62-107	5/16	7/8	9/32	\$6.86
62-108	8mm	22mm	7mm	\$5.29
62-109	15mm	35mm	11mm	\$3.01
62-110	3/16	3/4	1/4	\$6.41
62-111	15mm	32mm	9mm	\$6.41
62-112	1/4	5/8	3/16	\$5.99
62-113	3/16	5/8	3/16	\$5.99
62-114	1/2	1-1/8	5/16	\$6.41
62-116	1/2	1-3/8	7/16	\$6.86
62-118	10mm	26mm	8mm	\$6.41
62-120	5/16	1	10mm	\$11.27
62-121	5/16	1-1/4	10mm	\$11.48
62-122	5/16	1-1/2	10mm	\$11.83
62-124	5/16	26mm	7mm	\$11.20
62-128	5/16	30mm	7mm	\$11.20
62-136	17mm	2	10mm	\$18.17
62-139	1/2	1-1/2	5/16	\$14.98
62-144	3/16	3/4	12mm	\$6.41
62-146	3/16	7/8	12mm	\$5.99
62-148	3/16	1-1/8	12mm	\$6.13
62-150	3/16	1-3/8	12mm	\$6.41



FREUD

**Industrial Glue Line Rip Blades
(For Gang Ripping)**

PART #	DIA IN	DIA MM	KERF	PLATE	BORE	PIN HOLES	Z	GRIND	HOOK	APPLICATION	PRICE
LCL7M10038	12"	300	3.4	2.2	80	X	28	TC	20	Glue Line Rip	\$ 88.45
LCL7M10004	12"	305	3.2	2.2	1"	-	36	TC	20	Glue Line Rip	\$ 80.26
LCL7M10005	12"	305	3.2	2.2	3-1/8"	-	36	TC	20	Glue Line Rip	\$ 88.45
LCL7M10006	12"	305	4.3	2.8	50	-	36	TC	20	Glue Line Rip	\$ 88.45
LCL7M10007	12"	305	4.1	2.8	3-1/8"	-	36	TC	20	Glue Line Rip	\$ 88.45
LCL7M10008	12"	305	4.1	2.8	70	-	36	TC	20	Glue Line Rip	\$ 88.45
LCL7M10012	12"	305	4.1	2.8	1"	-	36	TC	20	Glue Line Rip	\$ 88.45
LCL7M10010	14"	355	4.3	3.0	3-1/8"	-	36	TC	20	Glue Line Rip	\$ 99.40
LCL7M10011	14"	355	4.3	3.0	70	-	36	TC	20	Glue Line Rip	\$ 99.40
LCL7M10013	14"	355	4.3	3.0	1"	-	36	TC	20	Glue Line Rip	\$ 99.40

Industrial Crosscutting Blades

PART #	DIA IN	DIA MM	KERF	PLATE	BORE	PIN HOLES	Z	GRIND	HOOK	APPLICATION	PRICE
LCL12108NF9	12"	305	3.0	2.5	5/8"	-	108	MTCG	-3	-	\$ 163.35
LCL129001UM	12"	305	3.0	2.5	1"	-	90	ATB+RKR	-3	-	\$ 147.77
LCL129002PM	12"	305	5/8"	2.5	5/8"	-	90	ATB+RKR	-3	-	\$ 147.77
LCL7M10045	12"	305	3.2	2.2	5/8"	-	100	4&1	10	Mitering Cut-off	\$ 156.24
LCL7M10047	14"	350	3.4	2.5	5/8"	-	100	4&1	10	Mitering Cut-off	\$ 168.53

Industrial Counter Top Cutting Blades

PART #	DIA IN	DIA MM	KERF	PLATE	BORE	PIN HOLES	Z	GRIND	HOOK	APPLICATION	PRICE
LCL7M10023	14"	355	4.4	3.0	1"	-	100	4&1	0	Counter Top	\$ 146.27
LCL7M10015	16"	406.4	4.4	3.0	1"	-	110	4&1	0	Counter Top	\$ 213.01

Industrial Counter Top Cutting Blads

PART #	DIA IN	DIA MM	KERF	PLATE	BORE	PIN HOLES	Z	GRIND	HOOK	APPLICATION	PRICE
LCL7M10016	14"	355	4.4	3.0	1"	-	84	MDTC	-3	Counter Top	\$ 125.62

**Specialty Blades
(for Cutting Non-Ferrous/ Plastics/ Corian)**

PART #	DIA IN	DIA MM	KERF	PLATE	BORE	PIN HOLES	Z	GRIND	HOOK	APPLICATION	PRICE
LCL7M10017	9"	220	3.2	2.2	30	X	64	MDTC	-3	Solid Surface	\$ 103.36
LCL7M10018	10"	254	3.2	2.2	1"	-	80	MDTC	-3	Solid Surface	\$ 111.30
LCL7M10019	10"	254	3.2	2.2	30	X	80	MDTC	-3	Solid Surface	\$ 111.30
LCL7M10021	12"	305	3.2	2.2	30	X	96	MDTC	-3	Solid Surface	\$ 120.09
LCL7M10022	12"	305	3.2	2.2	1"	-	96	MDTC	-3	Solid Surface	\$ 120.09
LCL7M10020	14"	355	3.5	2.5	30	X	108	MDTC	-3	Solid Surface	\$ 143.08

FREUD**Adjustable Scoring Blades
(for Sliding Table Saws)**

PART #	DIA IN	DIA MM	KERF	PLATE	BORE	PIN HOLES	Z	GRIND	HOOK	APPLICATION	PRICE
LI16MBA3	4"	100	2.8	3.6	20	-	12+12	Split Score		Schelling	\$ 97.13
LI16MBB3	4"	100	2.8	3.6	22	-	12+12	Split Score		Altendorf, Martin, Panhans	\$ 97.13
LI16MBC3	4"	100	2.8	3.6	3/4"	-	12+12	Split Score	11		\$ 89.25
LI16MAB3	5"	120	2.8	3.6	22	-	12+12	Split Score		Altendorf, Martin, Panhans	\$ 97.13
LI16MAC3	5"	120	2.8	3.6	3/4"	-	12+12	Split Score	11	SCMI	\$ 109.48
LI16MPF3	5"	120	2.8	3.6	50	Shimless (for RAPIDO)	12+12	Split Score	11	Altendorf, SCMI, Griggio-RAPIDO	\$ 95.80
LI76MDC3	5"	125	2.8	3.6	3/4"	-	12+12	Split Score	11		\$ 96.22

**Conical Scoring Blades
(for Horizontal Beam Saws)**

PART #	DIA IN	DIA MM	KERF	PLATE	BORE	PIN HOLES	Z	APPLICATION	PRICE
LI25M43FE3	5"	125	4.3-5.5	3.2	45		24		\$ 79.63
LI25M43KE3	6"	150	4.3-5.5	3.2	45	-	36	SCM	\$ 94.50
LI25M43LG3	6"	160	4.3-5.5	3.2	55	3/7/66+3/6/84	36	Gabbiani	\$ 96.22
LI25M47NE3	7"	180	4.7-5.9	3.5	45	-	36	Hol ma	\$102.34
LI25M43PA3	8"	200	4.3-5.5	3.2	20	-	36	Schelling	\$108.47
LI25M43PI3	8"	200	4.3-5.5	3.2	65	2/9/100+2/9/110	36	Selco	\$108.47
LI25M47PE3	8"	200	4.7-5.9	3.5	45	-	36	Hol ma	\$110.25
LI25M57PE3	8"	200	5.7-6.9	4.0	45		36	Hol ma	\$110.25

**Panel Sizing Blades
(for Horizontal Beam Saws)**

PART #	DIA IN	DIA MM	KERF	PLATE	BORE	PIN HOLES	Z	GRIND	HOOK	PRICE
LSB32001	12"	320	4.4	3.2	65	2/9/110	72	TCG	10	\$ 158.62
LSB35003	14"	350	4.4	3.2	30	2/10/1960	72	TCG	10	\$ 172.83
LSB35004	14"	350	4.4	3.2	60	2/14/100	72	TCG	10	\$ 173.67
LSB35005	14"	350	4.4	3.2	80	4/9/100+2/9/110+2/14+110	72	TCG	10	\$ 173.67
LSB35506	14"	350	4.4	3.2	80	4/13/80	72	TCG	10	\$ 177.00
LSB35504	14"	355	4.4	3.2	30	2/10/1960	54	TCG	10	\$ 173.67
LSB38004	15"	380	4.8	3.5	60	2/14/100	72	TCG	10	\$ 218.72
LSB40007	16"	400	4.4	3.2	30	2/10/1960	72	TCG	10	\$ 193.66
LSB40008	16"	400	4.4	3.2	75	4/15/105	72	TCG	10	\$ 195.34
LSB43009	17"	430	4.4	3.2	80	4/9/100+2/9/110+2/14+110	72	TCG	10	\$ 195.34
LSB45017	18"	450	4.8	3.2	60	2/14/125+2/17/100	72	TCG	10	\$ 273.84
LSB50011	20"	500	4.8	3.5	60	2/11/115	72	TCG	15	\$ 296.31
LSB60001	23"	600	5.8	4.0	60	2/11/115+2/19/120	60	TCG	15	\$ 352.24

Carbide Tipped Adjustable Scoring Blade for Scoring Coating on Double-Sided Laminate Panels

PART NUMBER	DIA IN	DIA MM	KERF	PLATE	BORE	PIN HOLES	Z	GRIND	HOOK	PRICE
LI16MBC3	4"	100	2.8	3.6	3/4"	-	12+12	Split Score	11	\$ 89.25
LI16MAC3	5"	120	2.8	3.6	3/4"	-	12+12	Split Score	11	\$109.48

FREUD **Vertical Panel Sizing Blades**
(Double Sided Melamine, Laminates, & Plywood Veneers)

PART #	DIA IN	DIA MM	KERF	PLATE	BORE	PIN HOLES	Z	GRIND	HOOK	PRICE
LU3A01	9"	220	3.2	2.2	30	2/7/42	64	Hi ATB	-5	\$ 100.63
LU3A02	10"	250	3.2	2.2	30	2/7/42+2/9/46.4+2/10/60	80	Hi ATB	-2	\$ 111.58
LU3A0203	10"	255	3.2	2.2	5/8"	-	80	Hi ATB	-2	\$ 92.54
LU3A03	12"	300	3.2	2.2	30	2/7/42+2/9/46.4+2/10/60	96	Hi ATB	2	\$ 141.96
LU3A06	12"	300	3.2	2.2	1"	-	96	Hi ATB	2	\$ 141.96
LU3A04	14"	350	3.5	2.5	30	2/9/46.4+2/10/60	108	Hi ATB	5	\$ 173.78

Vertical Panel Sizing Blades
(Hollow Face Ground)
(Double Sided Melamine, Laminates, & Plywood Veneers)

PART #	DIA IN	DIA MM	KERF	PLATE	BORE	PIN HOLES	Z	GRIND	HOOK	PRICE
LU3B01	9"	220	3.2	2.2	30	2/7/42	42	HG	10	\$ 86.70
LU3B02	10"	250	3.2	2.2	30	2/7/42+2/9/46.4+2/10/60	48	HG	10	\$ 104.93
LU3B03	12"	300	3.2	2.2	30	2/7/42+2/9/46.4+2/10/60	60	HG	10	\$ 128.03
LU3B04	14"	350	3.2	2.2	30	2/7/42+2/9/46.4+2/10/60	72	HG	10	\$ 158.24

Sliding Panel Sizing Blades
(Double Sided Melamine, Laminates, & Plywood Veneers)

PART #	DIA IN	DIA MM	KERF	PLATE	BORE	PIN HOLES	Z	GRIND	HOOK	PRICE
LU3D02	9"	220	3.2	2.2	30	2/7/42	64	TCG	5	\$ 92.37
LU3D04	10"	250	3.2	2.2	30	2/7/42+2/9/46.4+2/10/60	80	TCG	5	\$ 119.63
LU3D11	10"	250	3.2	2.2	30	2/7/42+2/9/46.4+2/10/61	60	TCG	10	\$ 100.14
LU3D13	12"	300	3.2	2.2	30	2/7/42+2/9/46.4+2/10/62	84	TCG	10	\$ 128.03
LU3D15	12"	300	3.2	2.2	30	2/7/42+2/9/46.4+2/10/61	96	TCG	10	\$ 153.69
LU3D21	12"	300	3.2	2.2	30	2/7/42+2/9/46.4+2/10/61	72	TCG	10	\$ 146.27
LU3D09	14"	350	3.5	2.5	30	2/9/46.4+2/10/60	108	TCG	5	\$ 173.29
LU3D17	14"	350	3.5	2.5	30	2/9/46.4+2/10/60	108	TCG	10	\$ 179.62

Vertical Panel Sizing Blades
(Double Sided Melamine, Laminates, & Plywood Veneers)

PART #	DIA IN	DIA MM	KERF	PLATE	BORE	PIN HOLES	Z	GRIND	HOOK	PRICE
LU3E03	12"	300	3.2	2.2	30	2/7/42+2/9/46.4+2/10/60	72	TCG	-6	\$ 92.23
LU3E04	14"	350	3.5	2.5	30	2/9/46.4+2/10/60	84	TCG	-6	\$ 117.64

Sliding & Vertical Panel Sizing Blades
(Double Sided Melamine, Laminates, Veneers & Plastics)

PART #	DIA IN	DIA MM	KERF	PLATE	BORE	PIN HOLES	Z	GRIND	HOOK	PRICE
LU3F01	9"	220	3.2	2.2	30	2/7/42	64	TCG	-3	\$ 88.27
LU3F02	10"	250	3.2	2.2	30	2/7/42+2/9/46.4+2/10/60	80	TCG	-3	\$ 103.36
LU3F03	12"	300	3.2	2.2	30	2/7/42+2/9/46.4+2/10/60	96	TCG	-3	\$ 128.77
LU3F04	14"	350	3.5	2.5	30	2/9/46.4+2/10/60	108	TCG	-3	\$ 162.16

FREUD**T.C.T. Ultra - Thin Kerf Sawblades**

PART #	DIA IN	DIA MM	KERF	PLATE	Z	BORE
LM08R1300	9"	225	1.7	1.2	36	65
LM08R1700	10"	250	1.7	1.2	36	40

T.C.T. Conical Scoring Sawblade

PART #	DIA IN	DIA MM	KERF	PLATE	Z	BORE
LI25M31BA3	4"	100	3.1-4.3	2.2	24	20
LI25M31DA3	4"	115	3.1-4.3	2.2	24	20
LI25M31EA3	5"	120	3.1-4.3	2.2	24	20
LI25M34EA3	5"	120	3.4-4.6	2.2	24	20
LI25M31FA3	5"	125	3.1-4.3	2.2	24	20
LI25M34FA3	5"	125	3.4-4.6	2.2	24	20
LI25M34FE3	5"	125	3.4-4.6	2.2	24	45
LI25M43FA3	5"	125	4.3-5.5	3.2	24	20
LI25M34HE3	5"	140	3.4-4.6	2.2	24	45
LI25M31KC3	6"	150	3.1-4.3	2.2	36	30
LI25M34KC3	6"	150	3.4-4.6	2.2	36	30
LI25M43KC3	6"	150	4.3-5.5	3.2	36	30
LI25M43NA3	7"	180	4.3-5.5	3.2	28	20
LI25M43NE3	7"	180	4.3-5.5	3.2	36	45
LI25M45NA3	7"	180	4.5-5.7	3.0	36	20

T.C.T. Adjustable Scoring Sawblades

PART #	DIA IN	DIA MM	KERF	PLATE	BORE	PIN HOLES	Z	GRIND	HOOK	PRICE
LI16MPF3	5"	120	2.8	3.6	3/4"	Shimless (for RAPIDO)	12+12	Split Score	11	\$ 95.80

T.C.T Sawblades to Cut Non-Ferrous Metals

PART #	DIA IN	DIA MM	KERF	PLATE	BORE	PIN HOLES	Z	GRIND	PRICE
LU5D06	8"	220	3.0		30	FT01	64	TCG	\$ 77.91
LU5B26	16"	420	3.5		30	2/11/70	120	TCG	\$ 205.91
LU5A21	18"	450	4.0		30	-	108	TCG	
LU5A25	20"	500	4.0		30	2/10,5/70	120	TCG	\$ 265.51
LU5C29	20"	500	4.0		32	2/11/63	120	TCG	\$ 258.37

Glue Line RIP

PART #	DIA IN	DIA MM	KERF	PLATE	BORE	Z	PRICE
LCL1M40003	15"	380	3.5		75	72	\$ 135.25

Carbide Tipped Panel Sizing Blade for Single or Multiple Panels

PART NUMBER	DIA IN	DIA MM	KERF	PLATE	BORE	Z	PRICE
LSB42001	16"	420	4.8	3.5	60	60	\$ 251.27
LSB30001	12"	300	4.4	3.0	30	60	\$ 143.64
LSB30003	12"	300	4.4	3.0	75	60	\$ 143.64
LSB30005	12"	300	4.4	3.0	30	72	\$ 147.77
LSB42002	16"	420	4.8	3.5	60	84	\$ 285.50
LSB45007	18"	450	4.4	3.2	30	72	\$ 255.43
LSB48004	19"	480	4.8	3.5	30	72	\$ 296.31
LSB52003	20"	520	4.8	3.5	60	72	\$ 330.54
LSB53001	21"	530	5.2	3.5	30	60	\$ 316.37
LSB60002	23"	600	5.8	4.0	60	72	\$ 375.66

FREUD

Industrial Thin Kerf Ultimate Cut-Off						Unique Slide Grind
LU74R - Perma-Shield Coating						
PART	DIA.	TEETH	ARBOR	KERF	PLATE	PRICE
LU74R008	8	64 ATB	5/8	.087	.063	\$57.47
LU74R010	10	80 ATB	5/8	.091	.071	\$73.47
LU74R012	12	96 ATB	1	.091	.071	\$107.24
LU74R014	14	108 ATB	1	.118	.087	\$117.32

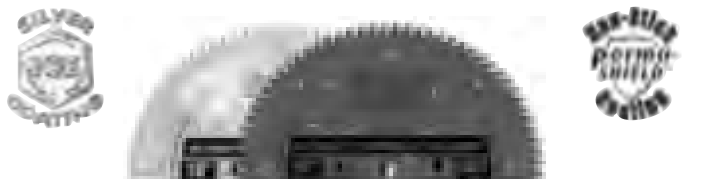



Premier Fusion General Purpose						HI-ATB Grind
Perma-Shield Coating, TiCo Carbide						
PART	DIA.	TEETH	ARBOR	KERF	PLATE	PRICE
P408	8	34 Hi-ATB	5/8	.126	.098	\$89.99
P410	10	40 Hi-ATB	5/8	.126	.098	\$99.99
P412	12	48 Hi-ATB	1	.126	.098	\$119.99
P414	14	54 Hi-ATB	1	.126	.098	\$144.99

Industrial Thin Kerf Fine Finish Crosscut						Thin Kerf
LU88R - Perma-Shield Coating						
PART	DIA.	TEETH	ARBOR	KERF	PLATE	PRICE
LU88R008	8	48 ATB	5/8	.083	.063	\$49.70
LU88R009	9	54 ATB	5/8	.090	.071	\$53.94
LU88R010	10	60 ATB	5/8	.090	.071	\$58.10
LU88R012	12	80 ATB	1	.094	.071	\$78.09

Ultimate Plywood , Melamine						HI-ATB Grind
LU80R - Perma-Shield Coating						
PART	DIA.	TEETH	ARBOR	KERF	PLATE	PRICE
LU80R010	10	80 Hi-ATB	5/8	.126	.087	\$94.71
LU80R012	12	96 Hi-ATB	1	.126	.087	\$143.71

Industrial Thin Kerf Sliding Compound Miter Saw						Negative Hook Angle
LU91M - Silver ICE Coating LU91R - Perma-Shield Coating						
PART	DIA.	TEETH	ARBOR	KERF	PLATE	PRICE
LU91M008	8.5	48 ATB	5/8	.090	.071	\$55.41
LU91M010	10	60 ATB	5/8	.090	.071	\$62.44
LU91M012	12	72 ATB	1	.090	.071	\$78.65
LU91R008	8.5	48 ATB	5/8	.090	.071	\$63.70
LU91R010	10	60 ATB	5/8	.090	.071	\$72.49
LU91R012	12	72 ATB	1	.090	.071	\$91.70

Thin Kerf Ultimate Plywood , Melamine						HI-ATB Grind
LU79 - Perma-Shield Coating						
PART	DIA.	TEETH	ARBOR	KERF	PLATE	PRICE
LU79R010	10	80 Hi-ATB	5/8	.098	.071	\$81.62
LU79R012	12	96 Hi-ATB	1	.098	.071	\$110.67

Industrial Cabinetmaker's Crosscut						ATB Tooth Design
LU73M- Silver ICE Coating with Precision Tensioning						
PART	DIA.	TEETH	ARBOR	KERF	PLATE	PRICE
LU73M008	8	48 ATB	5/8	.126	.087	\$63.00
LU73M009	9	54 ATB	5/8	.126	.087	\$70.07
LU73M010	10	60 ATB	5/8	.126	.087	\$69.93
LU73M012	12	72 ATB	1	.126	.087	\$98.25
LU73M014	14	84 ATB	1	.138	.098	\$120.61
LU73M016	16	96 ATB	1	.150	.110	\$144.80
LU73M018	18	108 ATB	1	.157	.118	\$231.04

Industrial Ultimate Cut-Off						Unique Slide Grind
LU85R- Perma-Shield Coating						
PART	DIA.	TEETH	ARBOR	KERF	PLATE	PRICE
LU85R008	8	64 ATB	5/8	.116	.098	\$73.71
LU85R009	9	72 ATB	5/8	.116	.098	\$87.05
LU85R010	10	80 ATB	5/8	.116	.098	\$90.16
LU85R012	12	96 ATB	1	.116	.098	\$136.85
LU85R014	14	108 ATB	1	.136	.118	\$150.08
LU85R015	15	108 ATB	1	.136	.118	\$150.08

FREUD

Thick Kerf		Industrial General Purpose				
		LU72M - Silver ICE Coating with Positive Hook Angle				
PART	DIA.	TEETH	ARBOR	KERF	PLATE	PRICE
LU72M008	8	34 ATB	5/8	.126	.087	\$54.95
LU72M009	9	36 ATB	5/8	.126	.087	\$58.87
LU72M010	10	40 ATB	5/8	.126	.087	\$58.66
LU72M012	12	48 ATB	1	.126	.087	\$79.98
LU72M014	14	54 ATB	1	.138	.098	\$95.62
LU72M016	16	60 ATB	1	.150	.110	\$117.01
LU72M018	18	66 ATB	1	.157	.118	\$183.54
LU72M020	20	72 ATB	1	.165	.126	\$206.22

Triple Chip Grind		Industrial Single Sided Laminate/Melamine				
		LU98R - Perma-Shield Coating with Positive Hook Angle				
HOOK						
PART	DIA.	TEETH	ARBOR	KERF	PLATE	ANGLE PRICE
LU98R007	7	56 TCG	5/8	.126	.087	5° \$85.75
LU98R008	8	64 TCG	5/8	.126	.087	5° \$91.98
LU98R009	9	72 TCG	5/8	.126	.087	5° \$102.73
LU98R010	10	80 TCG	5/8	.126	.087	5° \$107.21
LU98R012	12	96 TCG	1	.138	.098	5° \$126.88
LU98R014	14	108 TCG	1	.150	.110	7° \$149.24
LU98R016	16	120 TCG	1	.157	.118	10° \$201.99

Thick Plate		Industrial High-Production General Purpose				
		LU71M - Silver ICE Coating with Positive Hook Angle , Heavy Duty Thick Plate				
PART	DIA.	TEETH	ARBOR	KERF	PLATE	PRICE
LU71M014	14	42 ATB	1	.165	.118	\$96.60
LU71M016	16	48 ATB	1	.177	.118	\$115.36

Triple Chip Grind		Industrial Double Sided Laminate/Melamine				
		LU97R - Perma-Shield Coating LU97M - Silver ICE Coating				
PART	DIA.	TEETH	ARBOR	KERF	PLATE	PRICE
LU97M010	10	80 TCG	5/8	.126	.087	\$94.92
LU97R008	8	64 TCG	5/8	.126	.087	\$90.37
LU97R010	10	80 TCG	5/8	.126	.087	\$104.83
LU97R012	12	96 TCG	1	.126	.087	\$124.11
LU97R014	14	108 TCG	1	.138	.098	\$136.40

Large Gullets		Industrial Combination				
		LU84R - Perma-Shield Coating LU84M - Silver ICE Coating				
PART	DIA.	TEETH	ARBOR	KERF	PLATE	PRICE
LU84M008	8	40 COM	5/8	.126	.087	\$62.16
LU84M009	9	40 COM	5/8	.126	.087	\$64.75
LU84M011	11	50 COM	5/8	.126	.087	\$64.89
LU84M012	12	60 COM	1	.126	.087	\$98.25
LU84M014	14	70 COM	1	.157	.118	\$117.01
LU84M016	16	80 COM	1	.157	.118	\$132.27
LU84R008	8	40 COM	5/8	.126	.087	\$71.47
LU84R009	9	40 COM	5/8	.126	.087	\$74.48
LU84R011	11	50 COM	5/8	.126	.087	\$71.30
LU84R012	12	60 COM	1	.126	.087	\$112.98
LU84R014	14	70 COM	1	.157	.118	\$134.58
LU84R016	16	80 COM	1	.157	.118	\$158.27

T. C. G.		Industrial Thin Kerf Double Sided Laminate/Melamine				
		LU96R - Perma-Shield Coating				
PART	DIA.	TEETH	ARBOR	KERF	PLATE	PRICE
LU96R008	8	64 TCG	5/8	.083	.063	\$68.94
LU96R010	10	80 TCG	5/8	.091	.071	\$79.98
LU96R012	12	96 TCG	1	.091	.071	\$103.43

FREUD

Industrial Glue Line Ripping						
LM74M - Silver ICE Coating LM74R - Perma-Shield Coating						
PART	DIA.	TEETH	ARBOR	KERF	PLATE	PRICE
LM74M010	10	24 TCG	5/8	.118	.098	\$65.59
LM74R010	10	30 TCG	5/8	.118	.098	\$71.37
LM74R012	12	40 TCG	1	.118	.098	\$87.61
LM74R014	14	44 TCG	1	.138	.118	\$107.84

Industrial Heavy Duty Rip						
LM72M - Silver ICE Coating LM72R - Perma-Shield Coating with Extra Large, Flat Tooth Design						
PART	DIA.	TEETH	ARBOR	KERF	PLATE	PRICE
LM72M008	8	24 FLAT	5/8	.126	.087	\$51.49
LM72M010	10	24 FLAT	5/8	.126	.087	\$57.89
LM72M012	12	30 FLAT	1	.169	.118	\$77.74
LM72M014	14	30 FLAT	1	.169	.118	\$88.34
LM72M016	16	36 FLAT	1	.177	.118	\$107.63
LM72M018	18	36 FLAT	1	.126	.087	\$196.56
LM72R008	8	24 FLAT	5/8	.126	.087	\$57.47
LM72R010	10	24 FLAT	5/8	.126	.087	\$64.30
LM72R012	12	30 FLAT	1	.169	.118	\$86.84
LM72R014	14	30 FLAT	1	.169	.118	\$101.64
LM72R016	16	36 FLAT	1	.177	.118	\$123.76
LM72R018	18	36 FLAT	1	.126	.087	\$149.24

Industrial Thick Stock Rip						
LM71M - Silver ICE Coating with Heavy Duty Thick Plate						
PART	DIA.	TEETH	ARBOR	KERF	PLATE	PRICE
LM71M010	10	18 FLAT	5/8	.153	.118	\$65.21
LM71M012	12	20 FLAT	1	.165	.118	\$68.92
LM71M014	14	24 FLAT	1	.165	.118	\$83.06
LM71M016	16	28 FLAT	1	.177	.118	\$100.42

Industrial Thin Stock Non-Ferrous Metal						
LU90M - Silver ICE Coating with Freud-Made TiCo Carbide , 5° Positive Hook Angles						
PART	DIA.	TEETH	ARBOR	KERF	PLATE	PRICE
LU90M010	10	100 TCG	5/8	.110	.087	\$104.27
LU90M012	12	120 TCG	1	.118	.098	\$130.59

Industrial Thick Stock Non-Ferrous Metal - 7° Hook						
LU89M - Silver ICE Coating with Freud-Made TiCo Carbide						
PART	DIA.	TEETH	ARBOR	KERF	PLATE	PRICE
LU89M008	8	58 TCG	5/8	.122	.098	\$71.79
LU89M010	10	72 TCG	5/8	.122	.098	\$90.62
LU89M012	12	86 TCG	1	.122	.098	\$112.60
LU89M014*	14	100 TCG	1	.142	.118	\$135.07
LU89M015*	15	108 TCG	1	.142	.118	\$169.86
LU89M016*	16	114 TCG	1	.142	.118	\$191.38

*: Do Not Stock

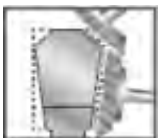
Industrial Plastic						
LU94M - Silver ICE Coating with -3° Hook Negative Angle						
PART	DIA.	TEETH	ARBOR	KERF	PLATE	PRICE
LU94M008	8	64 MTCG	5/8	.110	.087	\$61.25
LU94M010	10	80 MTCG	5/8	.110	.087	\$86.98
LU94M012	12	96 MTCG	1	.110	.087	\$130.52
LU94M014	14	108 MTCG	1	.110	.087	\$137.52

Industrial Solid Surface						
LU95R - Perma-Shield Coating LU95M - Silver ICE Coating						
PART	DIA.	TEETH	ARBOR	KERF	PLATE	PRICE
LU95M010	10	72 MTCG	5/8	.126	.087	\$117.92
LU95R010	10	72 MTCG	5/8	.126	.087	\$122.92
LU95R012	12	84 MTCG	1	.126	.087	\$130.73
LU95R014	14	96 MTCG	1	.138	.098	\$158.06

FREUD

Modified Triple Chip		Industrial Thick-Stock Laminate				
		LU92M - Silver ICE Coating with -6° Negative Hook Angles				
PART	DIA.	TEETH	ARBOR	KERF	PLATE	PRICE
LU92M008	8	48 MTCG	5/8	.126	.087	\$69.69
LU92M009	9	56 MTCG	5/8	.126	.087	\$84.67
LU92M010	10	60 MTCG	5/8	.126	.087	\$89.39
LU92M012	12	72 MTCG	1	.126	.087	\$108.68
LU92M014	14	84 MTCG	1	.138	.098	\$139.55

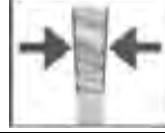
Thin Kerf		Thin Kerf Glue Line Rip				
		LM75R - Perma-Shield Coating with Freud-Made Ti-Co Carbide				
PART	DIA.	TEETH	ARBOR	KERF	PLATE	PRICE
LM75R010	10	30 TCG	5/8	.091	.071	\$59.18

Industrial Thin Kerf Rip		HI-ATB Grind				
		LU87R - Perma-Shield Coating with 20° Positive Hook Angle				
PART	DIA.	TEETH	ARBOR	KERF	PLATE	PRICE
LU87R008	8	22 FLAT	5/8	.087	.063	\$39.66
LU87R009	9	22 FLAT	5/8	.094	.071	\$43.09
LU87R010	10	24 FLAT	5/8	.094	.071	\$44.52

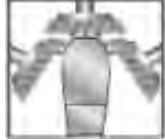
T. C. G.		Industrial Thin Kerf Non-Ferrous				
		LU77M - Silver ICE Coating with Freud-Made Ti-Co Carbide				
PART	DIA.	TEETH	ARBOR	KERF	PLATE	PRICE
LU77M008	8	64 TCG	5/8	.083	.063	\$62.30
LU77M010	10	80 TCG	5/8	.091	.071	\$77.04
LU77M012	12	96 TCG	1	.091	.071	\$92.82

Thin Kerf		Industrial Thin Kerf Combination				
		LU83R - Perma-Shield Coating				
PART	DIA.	TEETH	ARBOR	KERF	PLATE	PRICE
LU83R008	8	40 COM	5/8	.083	.063	\$50.23
LU83R010	10	50 COM	5/8	.091	.071	\$57.40
LU83R012	12	60 COM	1	.091	.071	\$73.54
LU83R015	15	80 COM	1	.102	.079	\$96.60

Thick Kerf		Industrial Thin Kerf General Purpose				
		LU86R - Perma-Shield Coating				
PART	DIA.	TEETH	ARBOR	KERF	PLATE	PRICE
LU86R008	8	34 ATB	5/8	.087	.063	\$41.06
LU86R010	10	40 ATB	5/8	.094	.071	\$46.17
LU86R012	12	48 ATB	1	.094	.071	\$54.81
LU86R014	14	54 ATB	1	.106	.079	\$74.31

	<i>Combination of unique design and special polymer filler reduces vibration above and beyond any other blade resulting in superior performance.</i>
---	--

T. C. G.		Industrial Heavy Duty Multi-Purpose				
		LU82M - Silver ICE Coating with Precision Tensioning				
PART	DIA.	TEETH	ARBOR	KERF	PLATE	PRICE
LU82M008	8	48 TCG	5/8	.126	.087	\$68.39
LU82M009	9	56 TCG	5/8	.126	.087	\$72.84
LU82M010	10	60 TCG	5/8	.126	.087	\$77.32
LU82M012	12	72 TCG	1	.126	.087	\$107.21
LU82M014	14	84 TCG	1	.169	.118	\$139.41
LU82M016	16	96 TCG	1	.177	.118	\$162.68

FREUD

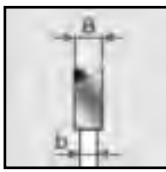
	Laminated Panels						
	LU3A - Silver ICE Coating with Variable Cutting Angle according to the diameter						
PART	DIA.	KERF	PLATE	BORE	TEETH	ANGLE	PRICE
LU3A01	220	3.2	2.2	30	64	-5	\$100.63
LU3A02	250	3.2	2.2	30	80	-2	\$111.58
LU3A06	300	3.2	2.2	25.4	96	2	\$141.96
LU3A03	300	3.2	2.2	30	96	2	\$141.96
LU3A04	350	3.5	2.5	30	108	5	\$173.78

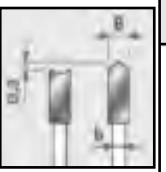
	Laminated Panels						
	LU3B - Silver ICE Coating with Concave Face and Positive Cutting Angle						
PART	DIA.	KERF	PLATE	BORE	TEETH	PRICE	
LU3B02	250	3.2	2.2	30	48	\$104.93	
LU3B03	303	3.2	2.2	30	60	\$128.03	

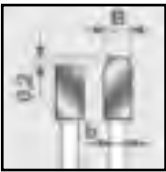
	Laminated Panels						
	LU3D - Silver ICE Coating with Positive Cutting Angle						
PART	DIA.	KERF	PLATE	BORE	TEETH	ANGLE	PRICE
LU3D02	220	3.2	2.2	30	64	5	\$92.37
LU3D04	250	3.2	2.2	30	80	5	\$119.63
LU3D06	300	3.2	2.2	30	96	5	\$153.69
LU3D11	250	2.2	--	30	60	10	\$100.14
LU3D21	300	3.2	2.2	30	72	10	\$146.27
LU3D15	300	3.2	2.2	30	96	10	\$153.96

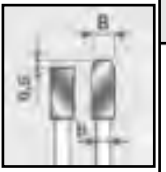
	Laminated Panels						
	LU3E - Silver ICE Coating with Negative Cutting Angle						
PART	DIA.	KERF	PLATE	BORE	TEETH	ANGLE	PRICE
LU3E02	220	3.2	2.2	30	56	--	\$75.57

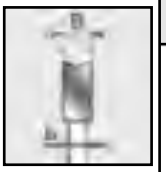
	Wood Panels						
	LU2B - Silver ICE Coating with Positive Cutting Angle						
PART	DIA.	KERF	PLATE	BORE	TEETH	PRICE	
LU2B03	300	3.2	2.2	30	96	\$57.54	

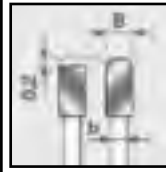
	Laminated Panels					
	LU3F - Silver ICE Coating with Negative Cutting Angle					
PART	DIA.	KERF	PLATE	BORE	TEETH	PRICE
LU3F01	220	3.2	2.2	30	64	\$88.27
LU3F02	250	3.2	2.2	30	80	\$103.36
LU3F03	300	3.2	2.2	30	96	\$128.77

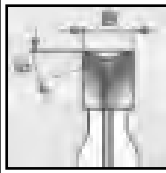
	Split Score					
	LI16M - Silver ICE Coating with Positive Cutting Angle					
PART	DIA.	KERF	BORE	TEETH	PRICE	
LI16MAA3	120	2.8-3.6	20	12+12	\$97.13	
LI16MBA3	100	2.8-3.6	20	12+12	\$97.13	
LI16MGA3	80	2.8-3.6	20	12+12	\$97.13	
LI16MBB3	100	2.8-3.6	22	12+12	\$97.13	
LI16MHA3	80	2.8-3.6	20	10+10	\$90.09	
LI16MEA3	125	2.8-3.6	20	14+14	\$99.72	
LI16MAB3	120	2.8-3.6	22	12+12	\$97.13	
LI16MFA3	125	2.8-3.6	20	12+12	\$97.13	
LI16MCA3	105	2.8-3.6	20	10+10	\$90.09	

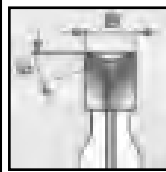
	Sizing Panels					
	LSB - Silver ICE Coating with Positive Cutting Angle					
PART	DIA.	KERF	PLATE	BORE	TEETH	PRICE
LSB35005	350	4.4	3.2	80	72	\$173.69
LSB38004	380	4.8	3.5	60	72	\$218.72
LSB35003	350	4.4	3.2	30	72	\$171.23
LSB35503	355	4.4	3.2	80	54	\$155.48
LSB35006	350	4.4	3.2	50	72	\$177.84
LSB35004	350	4.4	3.2	60	72	\$173.67
LSB38002	380	4.4	3.2	60	72	\$195.34
LSB35505	355	4.4	3.2	75	72	\$177.00
LSB35506	355	4.4	3.2	80	72	\$177.00
LSB32001	320	4.4	3.2	65	72	\$158.62



FREUD



Diablo Hi-Performance Saw Blades - For All Your Construction Needs

For Cutting Wood , Wood Composites							
PART	DIA.	MACHINE USE	APPLICATION	TEETH	ARBOR	KERF	PRICE
D0436X	4-3/8	Trim Saw (20mm , 3/8 Arbor)	Finish	36 ATB	20mm	.049	\$15.05
D0516X	5-3/8	Trim Saw (10mm Arbor)	Fast Framing	16 ATB	10mm	.049	\$12.57
D0524X	5-3/8	Trim Saw (10mm Arbor)	Framing	24 ATB	10mm	.049	\$14.49
D0536X	5-3/8	Trim Saw (10mm Arbor)	Finish	36 ATB	10mm	.049	\$17.36
D0620X	6	Porter Cable Saw Boss	Framing	20 ATB	1/2	.049	\$13.51
D0640X	6	Porter Cable Saw Boss	Finish	40 ATB	1/2	.049	\$17.26
D0624X/A	6-1/2	6-1/2 Circular Saw	Framing	24 ATB	5/8	.059	\$11.59
D0641X	6-1/2	6-1/2 Circular Saw	Finish	40 ATB	5/8	.059	\$19.81
D0724W	7-1/4	7-1/4 Worm Drive Circular Saw	Framing	24 ATB	5/8	.059	\$10.82
D0724X/A	7-1/4	7-1/4 Circular Saw	Framing	24 ATB	5/8	.059	\$11.38
D0740X/A	7-1/4	7-1/4 Circular Saw	Finish	40 ATB	5/8	.059	\$17.08
D0760X/A	7-1/4	7-1/4 Circular Saw	Ultra Fine Finish	60 ATB	5/8	.059	\$20.93
D0824X	8-8-1/4	8-1/4 Circular Saw	Framing	24 ATB	5/8	.094	\$18.10
D0840X	8-8-1/4	8-1/4 Circular Saw	Finish	40 ATB	5/8	.094	\$28.88
D0840S	8-1/2	8-1/2 Miter/ Slide Miter Saw	General Purpose	40 ATB	5/8	.094	\$33.01
D0860S	8-1/2	8-1/2 Miter/ Slide Miter Saw	Fine Finish	60 ATB	5/8	.087	\$45.92
D1024X	10	Table Saw	Ripping	24 ATB	5/8	.098	\$30.00
D1040X/A	10	10" Chop Miter Saw, Table Saw	General Purpose	40 ATB	5/8	.098	\$37.91
D1050X	10	10" Slide Miter Saw, Table Saw	Combination	50 ATB	5/8	.098	\$39.13
D1060S	10	10" Chop Miter Saw, Table Saw	Fine Finish	60 ATB	5/8	.087	\$51.77
D1060X	10	10" Chop Miter Saw, Table Saw	Fine Finish	60 Hi-ATB	5/8	.098	\$42.04
D1080X	10	10" Chop/Slide Miter Saw, Table Saw	Ultra Fine Finish	80 Hi-ATB	5/8	.098	\$56.32
D1040W	10-1/4	10-1/4" Beam Saw (BIGFOOT)	General Purpose Beam Cutting	40 ATB	5/8	.063	\$36.40
D1244X	12	12" Chop/Slide Miter Saw	General Purpose	44 ATB	1	.098	\$36.33
D1280X	12	12" Chop/Slide Miter Saw	Fine Finish	80 Hi-ATB	1	.118	\$59.85
D1484X	14	14" Chop Miter Saw	Fine Finish	84 ATB	1	.118	\$81.24
D1632X	16-5/16	16-5/16" Beam Saw	General Purpose Beam Cutting	32 ATB	1	.114	\$105.70
D1660X	16-5/16	16-5/16" Beam Saw	Fine Finish Beam Cutting	60 ATB	1	.114	\$130.97

Item Numbers ending in "X" are individually packaged. Item numbers ending with "A" are available in bulk packs of 10.
ATB=Alternate Top Bevel Tooth Design for a Superior Quality Finish. **Hi-ATB**=High Alternate Top Bevel Tooth Design for a Flawless Finish

For Cutting Non-Ferrous Metals, Plastics, Laminate , Laminate Flooring							
PART	DIA.	MACHINE USE	APPLICATION	TEETH	ARBOR	KERF	PRICE
D0756N	7-1/4	7-1/4 Circular Saw	Non-Ferrous Metals/Plastics	56 TCG	5/8	.106	\$42.84
D1080N	10	10" Chop/Slide Miter Saw Table Saw	Non-Ferrous Metals/Plastics	80 TCG	5/8	.094	\$59.15
D1084L	10	10" Chop/Slide Miter Saw Table Saw	Non-Ferrous Metals Laminate/Laminate Flooring	84 TCG	5/8	.098	\$61.43
D1296N	12	12" Chop/Slide Miter Saw	Non-Ferrous Metals/Plastics	96 TCG	1	.091	\$69.23
D1296L	12	12" Chop/Slide Miter Saw	Laminate/Laminate Flooring Plastics	96 TCG	1	.091	\$69.23

TCG=Triple Chip Grind Tooth Design for Superior Life in Abrasive Materials

FREUD



STEEL DEMON™

For Cutting Ferrous Metals (Mild Steel Only) Steel Studs, Angle Iron, Flat Bar, EMT Conduit, All-Thread

PART	DIA.	MACHINE USE	TEETH	ARBOR	MAX. CUT THICKNESS	PRICE
D0530F	5-3/8 / 137MM	5-3/8" Circular Saw - 10MM Arbor	30 TCG	10MM	1/8	\$29.23
D0530FM	5-3/8 / 137MM	For Panasonic , Similar Metal Cutting Saws	30 TCG	20MM	1/8	\$30.07
D0648F	6-1/2 / 165MM	6-1/2" Circular Saws - 5/8 Arbor	48 TCG	5/8	1/8	\$40.04
D0649F	6-3/4 / 172MM	6-3/4" Circular Saws - 20MM Arbor	48 TCG	20MM	1/8	\$40.04
D0738FM	7 / 180MM	For Evolution, Jancy, Morse , Similar Metal Cutting Saws	38 TCG	20MM	3/8	\$40.04
D0748FM	7 / 180MM	For Evolution, Jancy, Morse , Similar Metal Cutting Saws	48 TCG	20MM	1/8	\$42.00
D0770FM	7 / 180MM	For Evolution, Jancy, Morse , Similar Metal Cutting Saws	70 TCG	20MM	18 Ga. or thinner	\$50.72
D0738F	7-1/4" / 182MM	7-1/4" Circular Saw - 5/8 Arbor	38 TCG	5/8	3/8	\$40.04
D0748F	7-1/4" / 182MM	7-1/4" Circular Saw - 5/8 Arbor	48 TCG	5/8	1/8	\$42.00
D0756F	7-1/4" / 182MM	7-1/4" Circular Saw - 5/8 Arbor	56 TCG	5/8	1/8	\$47.60
D0770F	7-1/4" / 182MM	7-1/4" Circular Saw - 5/8 Arbor	70 TCG	5/8	18 Ga. or thinner	\$50.72
D0848F	8" / 203MM	8" Circular Saw	48 TCG	5/8	1/4	\$49.28
D1260F	12 / 305MM	12" Low RPM Metal Cutting Saws	60 TCG	1	1/4	\$100.91
D1472F	14 / 350MM	14" Low RPM Metal Cutting Saws	72 TCG	1	1/4	\$123.34

The Only Approved PCD Tipped HARDIE Blade.



HardieBlade™



James Hardie

The ONLY Approved PCD Tipped HardieBlade™

For Cutting All Types Fiber Cement Products

PART	DIA.	MACHINE USE	APPLICATION	TEETH	ARBOR	PRICE
D0706CH	7-1/4	7-1/4 Circular Saw	For Infrequent Use in James Hardie , Other Fiber Cement Products	6 TCG (TiCo)	5/8	\$17.15
D0704DH	7-1/4	7-1/4 Circular Saw	For Frequent Use in James Hardie , Other Fiber Cement Products	4 TCG (PCD)	5/8	\$56.35
D1006DH	10	10" Miter Saw, Table Saw	For Frequent Use in James Hardie , Other Fiber Cement Products	6 TCG (PCD)	5/8	\$93.73
D1208DH	12	12" Miter Saw	For Frequent Use in James Hardie , Other Fiber Cement Products	8 TCG (PCD)	1	\$125.93

*Dust generation does not necessarily correlate directly to exposure risk



FREUD

Unlimited Possibilities in Cabinet Door Making



2 pc. Premier Adjustable Rail and Stile Cutter Sets

The 2 piece Premier Adjustable Rail and Stile set allows you to create doors in a range of thicknesses and sizes with stub or extended tenons, plus variable groove thicknesses for panels. This set includes a wrench for adjusting the bits.

PART	BIT TYPE	PRICE
99-760	(1) Rail , (1) Stile Bit Round Over	\$123.90
99-761	(1) Rail , (1) Stile Bit Ogee	\$128.31
99-763	(1) Rail , (1) Stile Bit Round Over Bead	\$124.01
99-764	(1) Rail , (1) Stile Bit Bevel	\$124.01



3 pc. Premier Adjustable Cabinet Door Sets

This 3 piece cabinet door set includes the 2 piece Premier Adjustable Rail , Stile set plus an exclusive Quadra-cut Raised Panel Bit (either with or without a backcutter). There are 11 sets to choose from with the Adjustable Rail , Stile sets in either the Round over or Ogee profiles.

PART	BIT TYPE	PRICE
97-150	Round Over (99-760) Bevel (99-515)	\$201.60
97-152	Round Over (99-760) Cove (99-518)	\$201.60
97-154	Round Over (99-760) Ogee (99-520)	\$201.60
97-156	Round Over (99-760) Bevel w/Backcutter (99-566)	\$221.24
97-158	Round Over (99-760) Cove w/Backcutter (99-569)	\$221.24
97-250	Ogee (99-761) Bevel (99-515)	\$201.60
97-252	Ogee (99-761) Cove (99-518)	\$201.60
97-254	Ogee (99-761) Ogee (99-520)	\$201.60
97-258	Ogee (99-761) Cove w/Backcutter (99-569)	\$228.17
97-260	Ogee (99-761) Ogee w/Backcutter (99-571)	\$228.17
97-276	Ogee (99-761) Roman Ogee (99-513)	\$196.04



5 pc. Premier Adjustable Cabinet Door Sets

This 5 piece cabinet door set includes the 2 piece Premier Adjustable Rail , Stile set plus an exclusive Quadra-cut Raised Panel Bit, Door Lip Bit, and a Reversible Glue Joint Bit.

PART	BIT TYPE	PRICE
94-150	Rail , Stile Bits (2) Panel Bit (1) Reversible Glue Joint Bit (1) Door Lip Bit (1)	Round Over Ogee \$295.93

Add These Optional Cutters To Expand Your Possibilities



Optional Glass/Screen Panel Cutter

With the addition of this optional cutter to your basic 2 piece Premier Adjustable Rail , Stile set, you have the ability to create any shape and style of glass panel door with either traditional stub tenons or extended tenons for extra strength and durability. This set also gives you the capability to make screen doors.



PART	BIT TYPE	PRICE
54-760	Add-on cutter for making glass/screen panel doors	\$35.74



Optional Double Sided Profile Cutter

By adding this optional cutter set to your basic 2 piece Premier Adjustable Rail , Stile set, you can make double sided decorative profile doors in thicker stock. Ideal for woodworking projects such as media centers, libraries, and fine furniture.

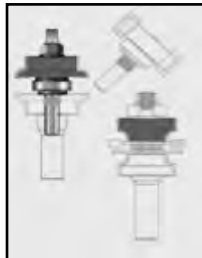

PART	BIT TYPE	PRICE
99-860	Rail Bit Cutter Stile Bit Cutter	RoundOver RoundOver \$91.74
99-861	Rail Bit Cutter Stile Bit Cutter	Ogee Ogee \$91.74
99-863	Rail Bit Cutter Stile Bit Cutter	Round Over Bead Round Over Bead \$91.74
99-864	Rail Bit Cutter Stile Bit Cutter	Bevel Bevel \$91.74

FREUD

Cabinet Door Making Sets

PART #	HEADS	GROOVERS	KNIVES	BORE	PRICE
RS1000	RS-S	RS-R	RS-L	1-1/4	\$374.36
	RS-K			1-1/4	
RS2000	RS-S	RS-K	RS-L	1-1/4	\$689.99
	RS-R		RS-A	1-1/4	
			RS-B		
			RS-C		
			RS-D		
			RS-E		
			RS-F		
			RS-G		
			RS-H		
			RS-I		



The End Of Splintering

Notice the eased over edges on the inside of the panel groove. Freud's specially designed cutter eliminates the possibility of splintering with oak and other popular woods. This feature also is an aid in finishing by preventing the finish build-up at the panel joint common with other rail and stile cutters.

Freud's revolutionary new system for making cabinet doors combines the flexibility of standard insert tooling with the performance of resharpenable Micro-grain Carbide knives. This gives cabinetmakers the ability to offer over 18 profiles of rail and stiles for cabinet doors at a fraction of the cost of fixed knife cutters. Plus, these cutters are packed with special features like: Eased panel slot edges to prevent splintering and improve finishing, zero down time to switch from the molding cut to the cope cut with matched reverse sets, and profiles that always match even after resharpening. Sets come with a sample of a rail and stile and complete manual for easy setup. Additional heads for multiple shaper operations are available.

Profile Knife RS-A for Glass Door Set - Up

DESCRIPTION	PRICE
RS-A Replacement knife Set (2 knives)	\$34.30

Uses: RS-A knife, RS-L knife with RS-R, RS-S Heads.

Use this set-up when a rabbeted groove is required to allow the insertion and removal of panel. Use small molding to hold glass in place. No shimming should be needed. For set-up, change the RS-S head to the bottom of the RS-R head, raise and lower spindle as indicated.

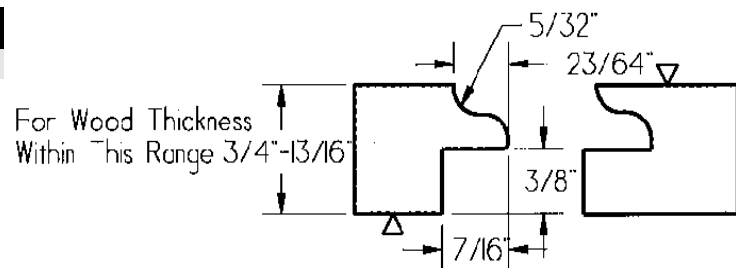

REPLACEMENT PROFILE KNIVES

RS-B REPLACEMENT KNIFE SET (2 knives)

Profile Knife RS-B for Glass Door Set-Up

USES

Knife: RS-B, RS-L
Head: RS-R, RS-S

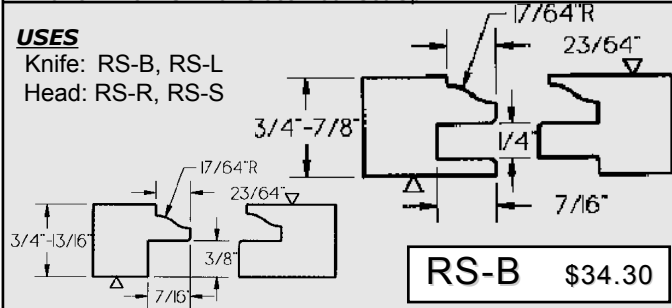

RS-C REPLACEMENT KNIFE SET (2 knives)

Profile knife RS-C for Glass Door Set-Up

USES

Knife: RS-C, RS-D, RS-L
Head: RS-R, RS-S

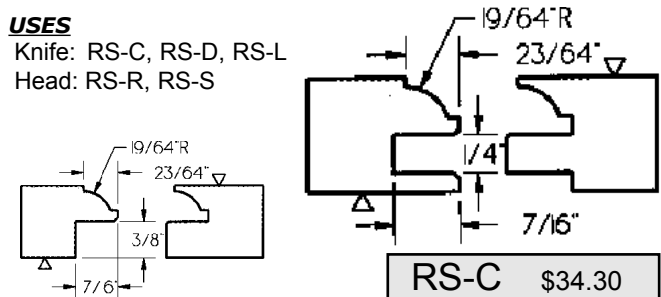

RS-D REPLACEMENT KNIFE SET (2 knives)

Profile knife RS-D for Glass Door Set-Up

USES

Knife: RS-D, RS-C, RS-L
Head: RS-R, RS-S

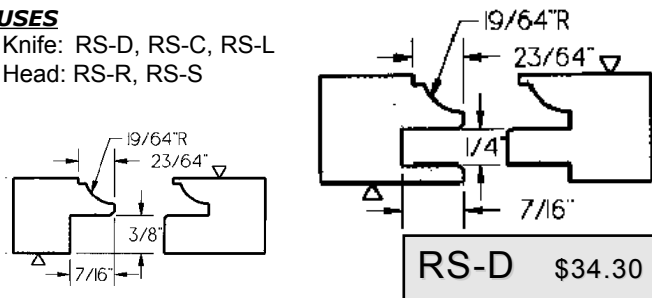

RS-E REPLACEMENT KNIFE SET (2 knives)

Profile knife RS-E for Glass Door Set-Up

USES

Knife: RS-E, RS-f, RS-L
Head: RS-R, RS-S

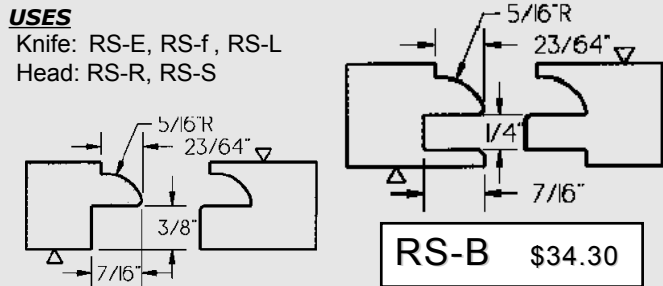

RS-F REPLACEMENT KNIFE SET (2 knives)

Profile knife RS-f for Glass Door Set-Up

USES

Knife: RS-F, RS-E, RS-L
Head: RS-R, RS-S

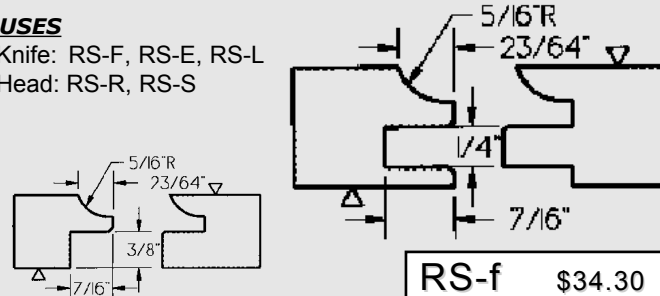

RS-G REPLACEMENT KNIFE SET (2 knives)

Profile knife RS-G for Glass Door Set-Up

USES

Knife: RS-G, RS-H, RS-L
Head: RS-R, RS-S

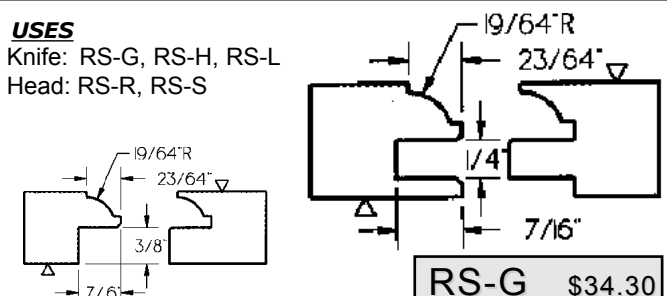

RS-H REPLACEMENT KNIFE SET (2 KNIVES)

Profile knife RS-H for Glass Door Set-Up

USES

knife: RS-f, RS-E, RS-L
Head: RS-R, RS-S

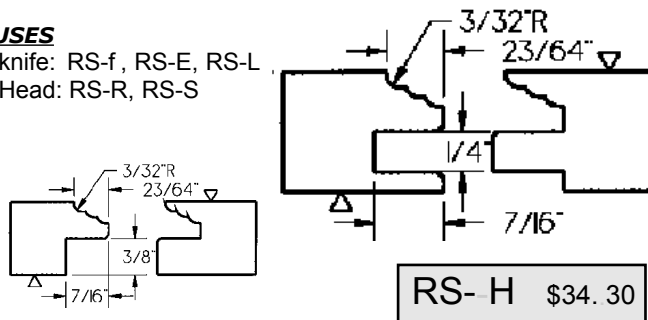

RS-I REPLACEMENT KNIFE SET (2 knives)

Profile knife RS-I for Glass Door Set-Up

USES

knife: RS-I, RS-L
Head: RS-R, RS-S

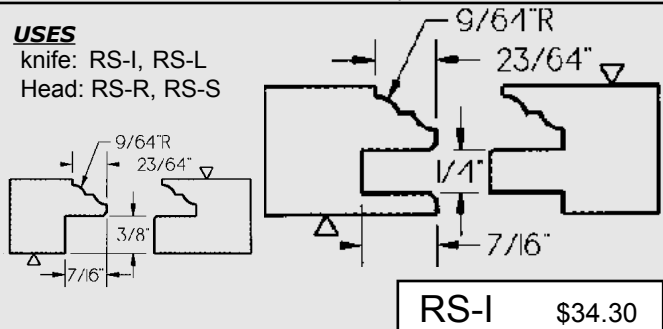

FREUD

Panel Raising Systems

PART	OVERALL DIA.	BORE DIA.	RUB COLLAR	PRICE
RP1000	5-1/2	1-1/4	RC101	\$160.44

Freud's revolutionary new system for making cabinet doors combines the flexibility of standard insert tooling with the performance of resharpenable Micro-grain Carbide knives. This gives cabinetmakers the ability to foer over 10 profiles of raised panels for cabinet doors at a fraction of the cost of fixed knife cutters. Plus, these cutters have a specially designed raised panel knife that will leave cross grain cuts as smooth and splinter free as

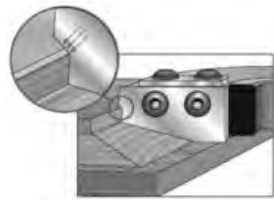

cuts with the grain. The head is manufactured out of a high grade aircraft aluminum, so weight is kept to a minimum while strength is maintained. Anti-Kickback Design of the head reduces the likelihood of kicbacks. All sets are packaged in a sturdy case for convnient storage.

Raised Panel Cutters

ITEM	BORE DIA.	PRICE
RP2000		\$352.98
Backcutter (RP-OPS)	1-1/4	\$21.46
knife (RP-A)	1-1/4	\$36.40
knife (RP-B)	1-1/4	\$36.40
knife (RP-C)	1-1/4	\$36.40
knife (RP-D)	1-1/4	\$36.40
knife (RP-E)	1-1/4	\$36.40

Typical raised panel cutters leave splinters when cuttin across the end grain. Freud's new cutter pushes down and shears off the wood fibers and leaves it splinter-free. This is a big time saver beacuse it reduces the mount of sanding required.



Raised Panel Profile Knives

These knives are designed for raising 5/8" thick panels with 1/4" tongue. Can be used for raising 3/4" panels when using optional back cutters RP-OPS or RP-OPB. Uses: Knife RP-A, and Head RP-1000.

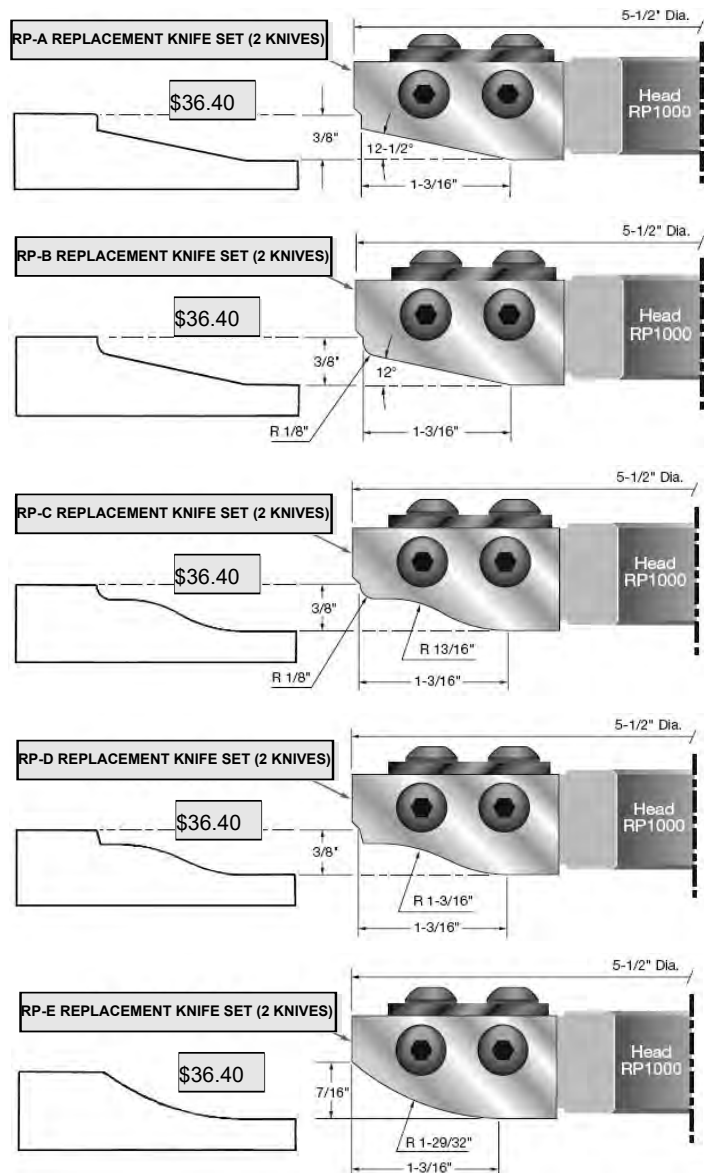

Back-Cutters for Performance System Raised Panel Cutters

Description	Price
RP-OPS Back Cutter	\$21.46

Designed to be used with knives RP-A, RP-B, RP-C, RP-D, RP-E on the RP1000 head. Allows the use of 3/4" to 13/16" thick panels while maintaining the 1-4" tongue.

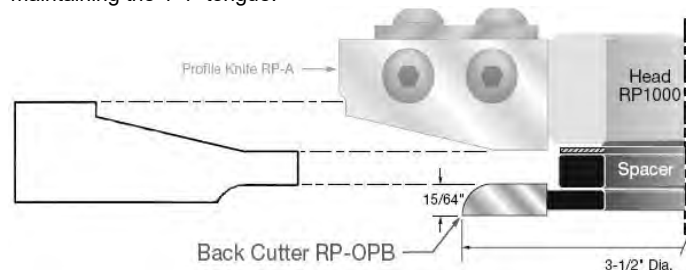

Description	Price
RP-OPB Back Cutter	\$21.46

Spacer included when purchasing back cutters. Raised Panel Cutter Not Included.

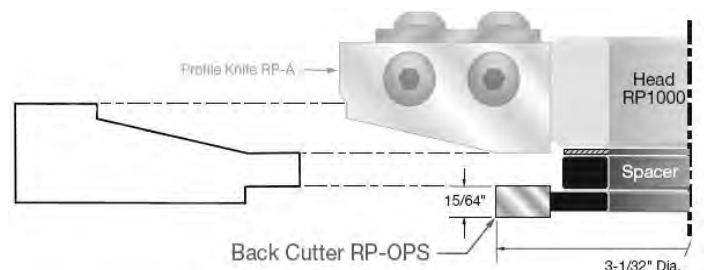

FREUD

DOOR EDGE PROFILE CUTTERS

Two Piece 32mm Door Edge top Profile Cutters

PART	DESCRIPTION	PRICE
DE32-A thru DE32-I	2 Repl. Profile knives	\$52.61
DE320-T	4-17/64" Diameter Head with 1-1/4" Bore	\$159.78
DE320-U	3-1/2" Diameter Head with 1-1/4" Bore	\$142.56

USES: Head DE320-T and Selected Profile Knives for door edge profile.

Examples Shown in Box are 1 :1 Scale

32mm Door Edge Bottom Profile Cutters

PART	DESCRIPTION	PRICE
DE32-J thru. DE32-M	2 Profile knives	\$39.45
DE-320-U	3-1/2" Diameter Head with 1-1/4" Bore	\$142.56

These profile knives are used with cutter head DE-320-U to provide a smooth edge treatment on cabinet doors. Pattern allows opening of cabinet doors and drawers without pulls.



Profile Knife RS-A Raised Panel Door System

DESCRIPTION	PRICE
RS-A Replacement knife Set (2 knives)	\$34.30

Uses: RS-A knife, RS-L knife with RS-R, RS-S Heads.

RS-A Set-Up

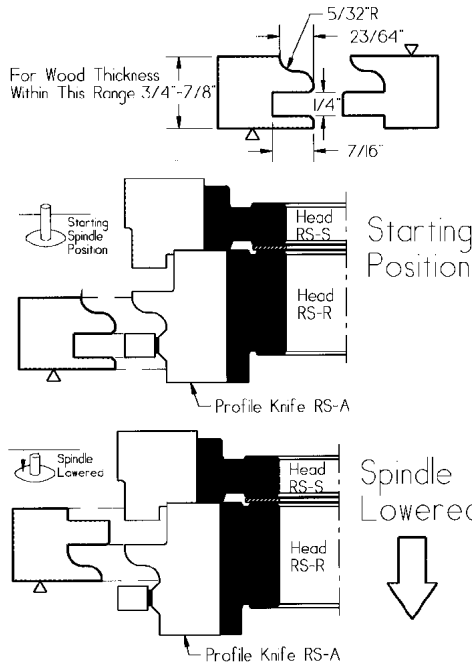

Use this set-up when constructing raised panel doors. Eased over edges on inside of panel groove provides less splintering, easier finishing, and easier insertion of panels. Shimming should be done between the cutter heads to achieve the fit required.

One Piece Door Edge Profile Cutters

PART	DESCRIPTION	PRICE
DE-A thru. DE-F	2 Profile knives	\$76.69
DE-1000	4" Diameter Head with 1-1/4" Bore	\$172.06

These profile knives are used with cutter head DE-1000 to provide a smooth edge treatment on cabinet doors. Pattern allows opening of cabinet doors and drawers without pulls.

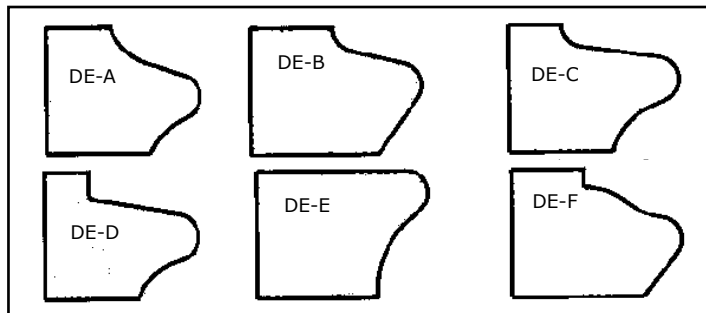

FREUD

FIXED WING CUTTERS

Straight Edge Cutters

PART	OVERALL DIA.	CARBIDE HEIGHT	BORE DIA.	RUB COLLAR	PRICE
EC140	2-7/8	1/4	3/4	RC-003	\$43.65
EC141	2-7/8	3/8	3/4	RC-003	\$48.06
EC142	2-7/8	1/2	3/4	RC-003	\$51.21
EC143	2-7/8	5/8	3/4	RC-003	\$56.00
EC144	2-7/8	3/4	3/4	RC-003	\$59.19
EC146	2-7/8	1	3/4	RC-003	\$63.14
UP140	3-9/16	1/4	1-1/4	RC501	\$72.52
UP141	3-9/16	3/8	1-1/4	RC501	\$77.67
UP142	3-9/16	1/2	1-1/4	RC501	\$80.78
UP143	3-9/16	5/8	1-1/4	RC501	\$82.85
UP144	3-9/16	3/4	1-1/4	RC501	\$90.09
UP145	3-9/16	7/8	1-1/4	RC501	\$96.32
UP146	3-9/16	1	1-1/4	RC501	\$102.52
UP147	3-9/16	1-1/4	1-1/4	RC501	\$114.91
UP148	3-9/16	1-1/2	1-1/4	RC501	\$123.20
UP149	3-9/16	1-3/4	1-1/4	RC501	\$128.42
UP150	3-9/16	2	1-1/4	RC501	\$137.73
UP151	3-9/16	2-1/4	1-1/4	RC501	\$147.00
UP152	3-9/16	2-1/2	1-1/4	RC501	\$155.33
UP153	3-9/16	3	1-1/4	RC501	\$170.87

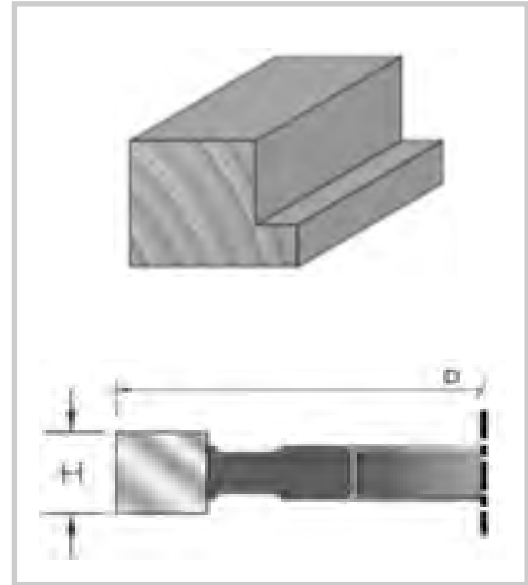

Groovers

PART	OVERALL DIA.	OF WINGS	CARBIDE HEIGHT	BORE DIA.	PRICE
UP170	4	6	1/8	1-1/4	\$93.31
UP171	4	6	1/4	1-1/4	\$102.52
UP172	4	6	3/8	1-1/4	\$109.80
UP173	4	6	1/2	1-1/4	\$120.12
UP174	4	6	3/4	1-1/4	\$129.43
UP175*	6	8	1/8	1-1/4	\$121.66
UP176*	6	8	1/4	1-1/4	\$137.31
UP177*	6	8	3/8	1-1/4	\$145.99
UP178*	6	8	1/2	1-1/4	\$155.33
UP179*	6	8	3/4	1-1/4	\$171.92
UP181**	8	12	1/4	1-1/4	\$196.74
UP182**	8	12	3/8	1-1/4	\$207.06
UP183**	8	12	1/2	1-1/4	\$217.46
UP184**	8	12	3/4	1-1/4	\$243.99

*: Cuts 1-5/8" Deep

** : Cuts 2-1/2" Deep

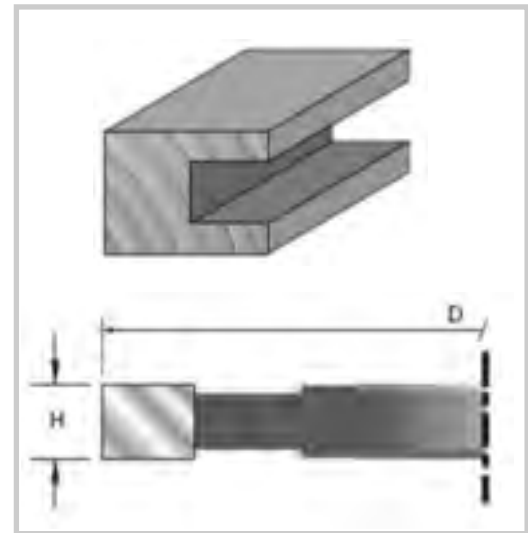

Reversible Glue Joint Cutters

PART	OVERALL DIA.	CUT DEPTH	CARBIDE HEIGHT	MINOR HEIGHT	MINOR ANGLE	BORE DIA.	PRICE
UP031	3-9/16	5/32	1-3/16	23/64	30	1-1/4	\$160.90

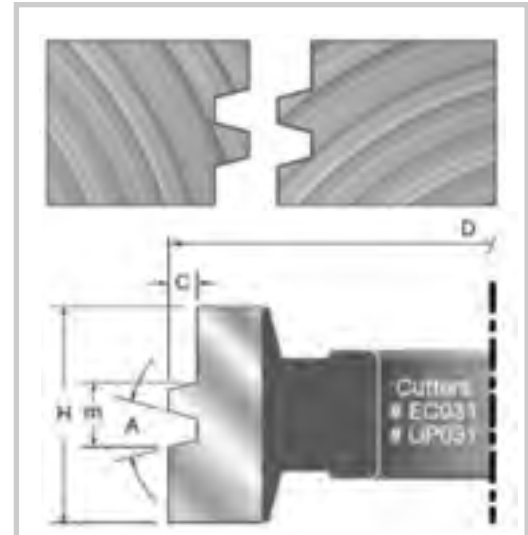

FREUD

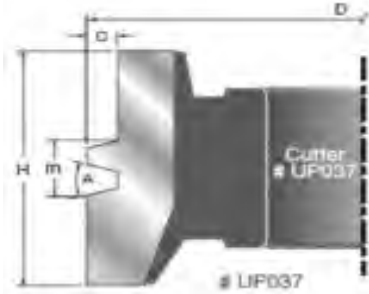

FIXED WING CUTTERS (continued)

Glue Joint Cutters

PART	OVERALL DIA.	CUT DEPTH	CARBIDE HEIGHT	ANGLE	MINOR HEIGHT	BORE DIA.	PRICE
UP035	3-9/16	13/64	23/8	32°	49/64	1-1/4	\$180.15
UP036	3-9/16	13/64	1-23/32	32°	49/64	1-1/4	\$165.66
UP037	3-9/16	13/64	1-23/32	32°	13/32	1-1/4	\$163.63

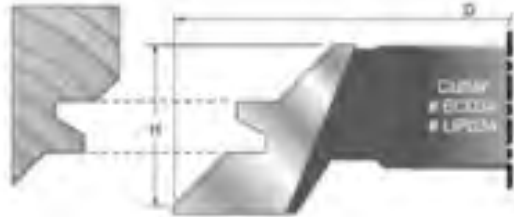

Tongue and Groove Lock Miter Cutters

PART	OVERALL DIA.	CARBIDE HEIGHT	BORE DIA.	PRICE
EC034	4-5/32	1-5/32	3/4	\$118.37
UP034	4-3/4	1-3/16	1-1/4	\$195.72

UP190

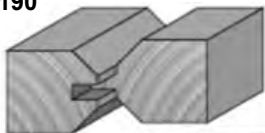

v-Paneling Cutter Sets

PART	OVERALL DIA.	CUT DEPTH	CARBIDE HEIGHT	MINOR HEIGHT	TENON THICKNESS	TENON LENGTH	BORE DIA.	PRICE
UP190	4-1/8	19/64	31/32-1-5/64	19/64	3/16-19/64	19/64	1-1/4	\$455.60
UP191	4-1/8	9/32	1-1/16-1-3/16	19/64	3/16-5/16	9/32	1-1/4	\$428.65

UP191



Drawer Lock Cutters

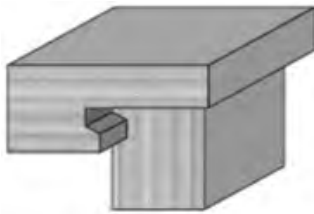

PART	OVERALL DIA.	CUT DEPTH	CARBIDE HEIGHT	MINOR HEIGHT	BORE DIA.	PRICE
EC240	2-7/8	1/8	33/64	5/32	3/4	\$63.95
UP240	3-15/16	1/8	33/64	5/32	1-1/4	\$98.39

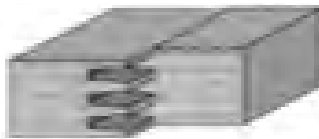

Finger Joint Cutter

PART	OVERALL DIA.	CUT DEPTH	CARBIDE HEIGHT	MINOR HEIGHT	ANGLE	BORE DIA.	PRICE
UP250	3-9/16	11/32	25/32	15/64	10°	1-1/4	\$157.39

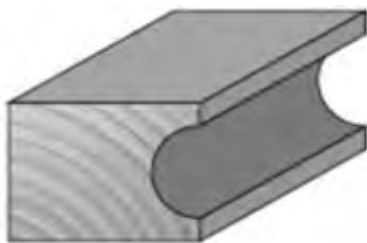

Convex Radius Cutters

PART	OVERALL DIA.	CARBIDE HEIGHT	LARGE RADIUS	BORE DIA.	PRICE
EC101	2-7/8	1/4	1/8	3/4	\$49.63
EC102	2-7/8	3/8	3/16	3/4	\$56.00
EC103	2-7/8	1/2	1/4	3/4	\$61.57
EC104	2-7/8	5/8	5/16	3/4	\$67.13
EC105	2-7/8	3/4	3/8	3/4	\$73.50
UP101	3-9/16	1/4	1/8	1-1/4	\$75.60
UP102	3-9/16	3/8	3/16	1-1/4	\$81.80
UP103	3-9/16	1/2	1/4	1-1/4	\$95.31
UP104	3-9/16	5/8	5/16	1-1/4	\$104.62
UP105	3-9/16	3/4	3/8	1-1/4	\$111.83
UP106	3-9/16	7/8	7/16	1-1/4	\$118.06
UP107	3-9/16	1	1/2	1-1/4	\$125.30
UP108	3-9/16	1-1/4	5/8	1-1/4	\$152.22
UP109	3-5/8	1-1/2	3/4	1-1/4	\$162.58
UP110	4	2	1	1-1/4	\$215.39



FREUD

FIXED WING CUTTERS (continued)

Concave Radius Cutters

PART	OVERALL DIA.	CARBIDE HEIGHT	LARGE RADIUS	BORE DIA.	PRICE
EC120	2-7/8	5/8	1/8	3/4	\$53.62
EC121	2-7/8	25/32	3/16	3/4	\$57.58
EC122	2-7/8	15/16	1/4	3/4	\$61.57
EC123	2-7/8	1-1/8	5/16	3/4	\$65.52
EC124	2-7/8	1-1/4	3/8	3/4	\$69.48
UP120	3-9/16	21/32	1/8	1-1/4	\$102.52
UP121	3-9/16	13/16	3/16	1-1/4	\$113.89
UP122	3-9/16	31/32	1/4	1-1/4	\$121.14
UP123	3-9/16	1-1/8	5/16	1-1/4	\$130.48
UP124	3-9/16	1-9/32	3/8	1-1/4	\$139.83
UP125	3-5/8	1-13/32	7/16	1-1/4	\$155.33
UP126	4	1-39/64	1/2	1-1/4	\$172.94
UP127	4-3/8	1-51/64	5/8	1-1/4	\$198.80
UP128	4-11/16	2-7/64	3/4	1-1/4	\$231.95
UP129	5-1/8	2-39/64	1	1-1/4	\$277.48

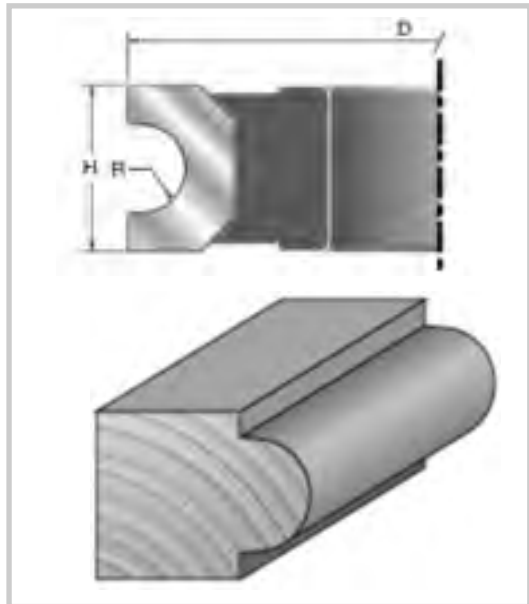

Combination Convex , Concave Cutters

PART	OVERALL DIA.	CARBIDE HEIGHT	LARGE RADIUS	BORE DIA.	PRICE
UP130	3-9/16	9/16	1/8	1-1/4	\$103.53
UP131	3-9/16	19/32	3/16	1-1/4	\$103.53
UP132	3-9/16	3/4	1/4	1-1/4	\$113.89
UP133	3-9/16	63/64	5/16	1-1/4	\$127.40
UP134	3-9/16	1-1/64	3/8	1-1/4	\$127.40
UP135	3-5/8	1-1/8	7/16	1-1/4	\$141.86
UP136	4-1/4	1-23/64	1/2	1-1/4	\$156.80
UP137	4-11/16	1-35/64	5/8	1-1/4	\$177.03
UP138	4-11/16	1-53/64	3/4	1-1/4	\$213.29
UP139	5-1/8	2-1/4	1	1-1/4	\$268.17

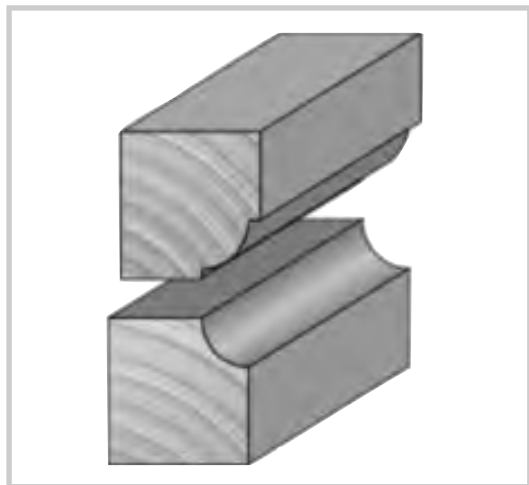

Roman Ogee Cutters

PART	OVERALL DIA.	CARBIDE HEIGHT	MINOR HEIGHT	LARGE RADIUS	BORE DIA.	PRICE
EC005	2-7/8	25/32	9/32	15/64	3/4	\$57.58
UP005	3-5/8	45/64	13/64	15/64	1-1/4	\$135.63

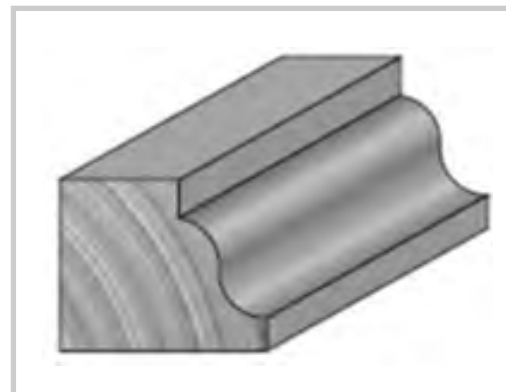

FREUD

FIXED WING CUTTERS (continued)

Matched Reverse Detail Cutters

PART	OVERALL DIA.	CUT DEPTH	CARBIDE HEIGHT	MINOR HEIGHT	LARGE RADIUS	ANGLE	BORE DIA.	PRICE
UP280	3-15/16	25/64	1-3/32	23/64	11/64	-	1-1/4	\$129.43
UP281	3-15/16	15/32	1-3/32	5/16	5/32	-	1-1/4	\$127.40
UP282	3-15/16	5/8	1-3/32	1/2	15/64	-	1-1/4	\$129.43
UP283	3-15/16	33/64	63/64	33/64	13/64	-	1-1/4	\$127.33
UP284	3-15/16	43/64	63/64	33/64	23/64	-	1-1/4	\$132.55
UP285	3-15/16	15/32	63/64	19/32	15/64	-	1-1/4	\$129.43
UP286	3-15/16	3/4	63/64	23/64	23/64	-	1-1/4	\$136.68
UP287	3-15/16	19/32	63/64	3/4	5/16	-	1-1/4	\$129.43
UP288	4-1/8	5/8	63/64	17/64	-	23°	1-1/4	\$134.61

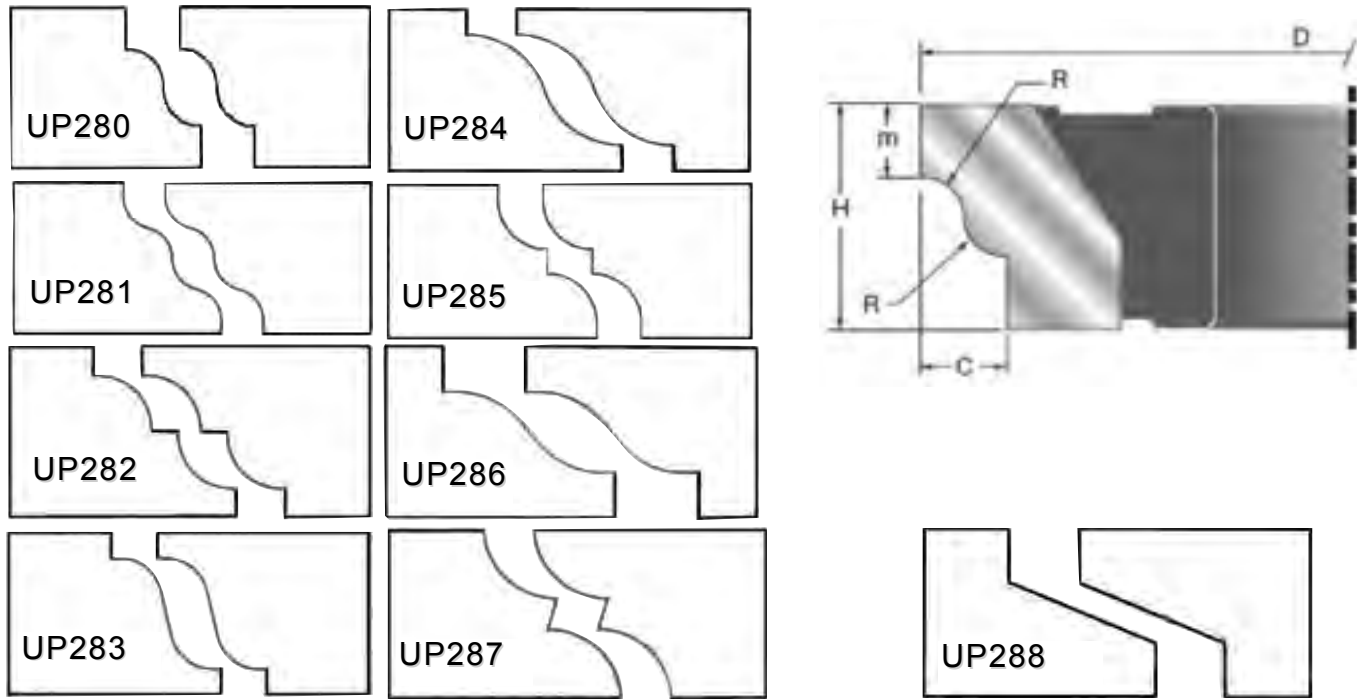

Multi-Proile Cutter

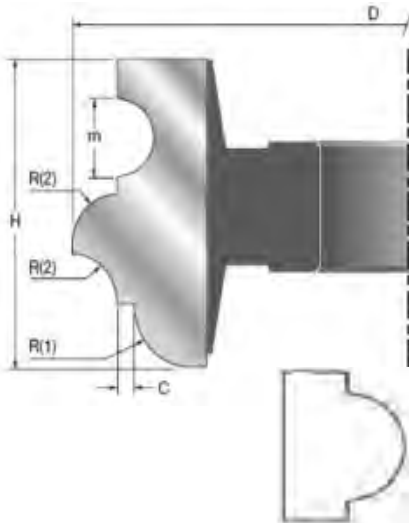

PART	OVERALL DIA.	CUT DEPTH	CARBIDE HEIGHT	MINOR HEIGHT	LARGE RADIUS	ANGLE	BORE DIA.	PRICE
Pk 1	3-3/4	1/8	1-15/16	1/2	25/64	5/16	3/4	\$178.92
Pk 2	4-23/32	1/8	1-15/16	1/2	25/64	5/16	1-1/4	\$189.49

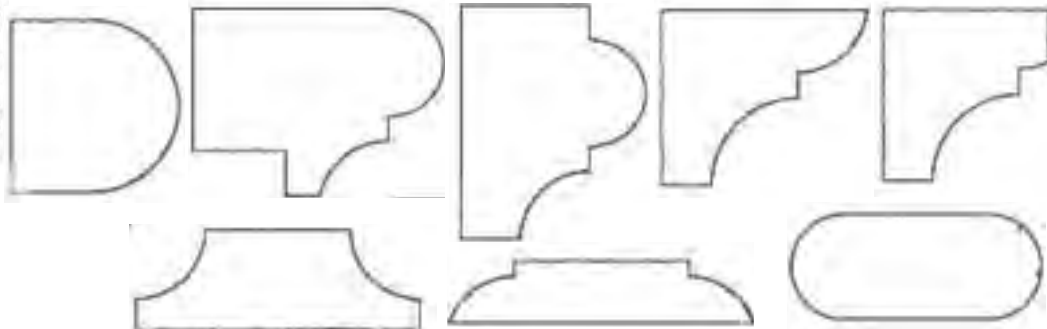

FREUD

Rail, Stile Cutters

3/4" Stock male, female Cabinet Door Cutter Sets

PART	OVERALL DIA.	CUT DEPTH	CARBIDE HEIGHT	TENON THICKNESS	TENON LENGTH	LARGE RADIUS	BORE DIA.	PRICE
EC260	2-7/16	15/64	1	15/64	7/16	15/64	3/4	\$242.38
UP260	3-9/16	15/64	1	15/64	7/16	15/64	1-1/4	\$372.33
EC261	2-11/16	11/32	1	15/64	7/16	9/32	3/4	\$242.38
UP261	3-9/16	11/32	29/32	15/64	7/16	9/32	1-1/4	\$372.33
UP262*	3-9/16	15/64	1-1/16	15/64	7/16	1/8	1-1/4	\$448.00
EC263	2-11/16	11/32	1	15/64	7/16	9/32	3/4	\$242.38
UP263	3-9/16	11/32	1	15/64	7/16	9/32	1-1/4	\$372.33
UP264	3-9/16	11/32	1	15/64	7/16	9/64	1-1/4	\$385.28
UP265*	3-9/16	15/64	63/64	15/64	7/16	13/64	1-1/4	\$430.12

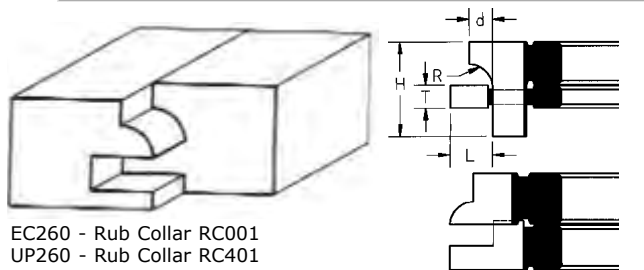

EC260 - Rub Collar RC001
UP260 - Rub Collar RC401

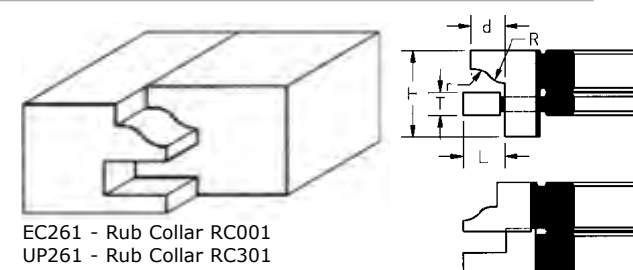

EC261 - Rub Collar RC001
UP261 - Rub Collar RC301

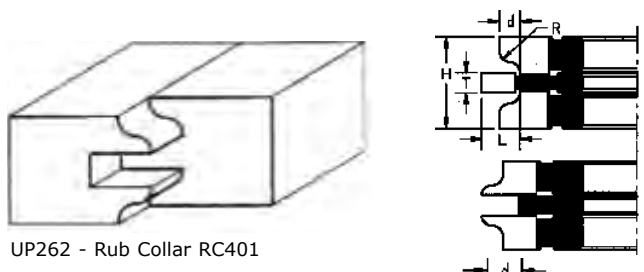

UP262 - Rub Collar RC401

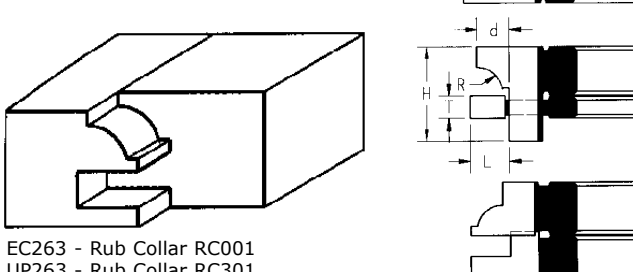

EC263 - Rub Collar RC001
UP263 - Rub Collar RC301

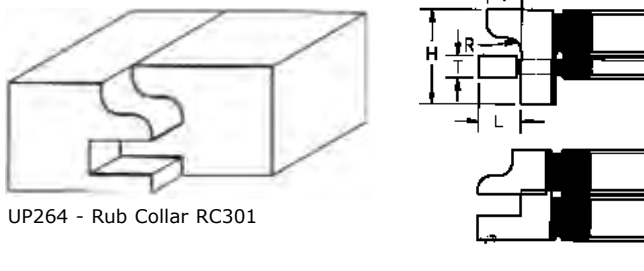

UP264 - Rub Collar RC301

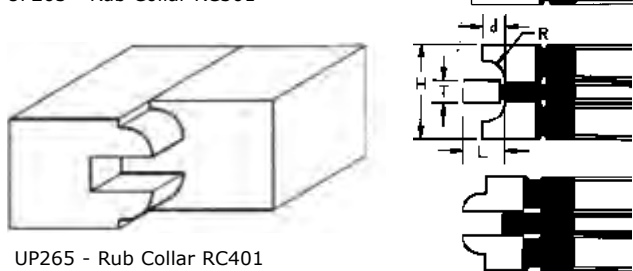

UP265 - Rub Collar RC401

1" Stock male, female Cabinet Door Cutter Sets

PART	DIA.	d	H	T	L	R	BORE	PRICE
EC266	2-27/32	15/64	1-3/16	15/64	7/16	15/64	3/4	\$275.77
UP266	3-9/16	15/64	1-3/16	15/64	7/16	15/64	1-1/4	\$451.99
UP267	3-9/16	11/32	1-11/32	15/64	7/16	9/32	1-1/4	\$466.94
UP268	3-9/16	23/64	1-3/16	15/64	7/16	5/32	1-1/4	\$470.89

d determines bore size. See Rub Collar Section.

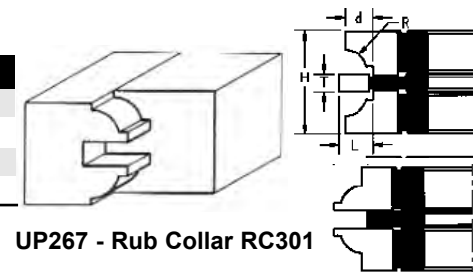

UP267 - Rub Collar RC301

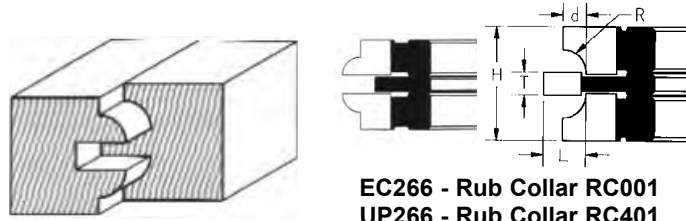

EC266 - Rub Collar RC001
UP266 - Rub Collar RC401

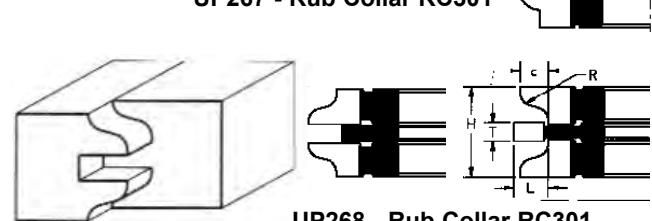

UP268 - Rub Collar RC301

FREUD

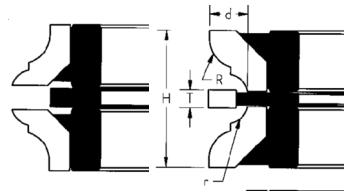
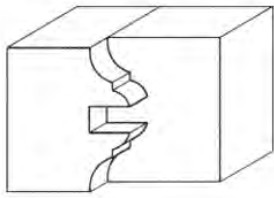

EC090 - Rub Collar RC001
UP090 - Rub Collar RC101

1-3/4" Stock male, female Exterior
Door Cutter Sets

PART	DIA.	d	H	T	R	r	BORE	PRICE
EC091	2-7/8	1/2	--	15/64	3/8	9/32	3/4	\$275.77
UP091	3-9/16	1/2	1-47/64	15/64	21/64	9/32	1-1/4	\$511.49

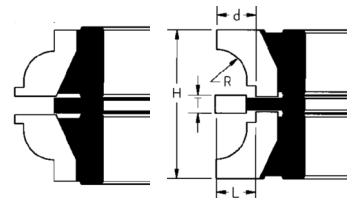
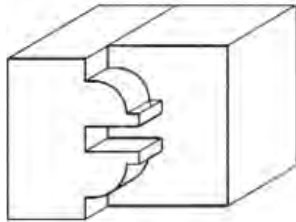

EC274 - Rub Collar RC001
UP274 - Rub Collar RC201

1-3/8" Stock male, female interior Door
Cutter Sets

PART	DIA.	H	h	T	L	R	BORE	PRICE
UP269	3-9/16	1-37/64	7/8	15/64	33/64	1/8	1-1/4	\$480.87
EC270	2-27/32	1-37/64	--	15/64	33/64	5/16	3/4	\$275.77
UP270	3-9/16	1-17/32	--	15/64	33/64	5/16	1-1/4	\$485.84
UP272	3-9/16	1-1/2	--	15/64	17/32	3/16	1-1/4	\$487.83

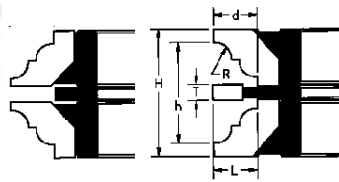
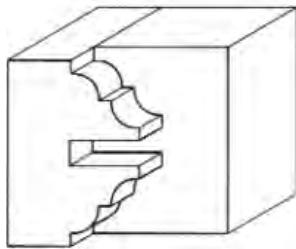

UP273 - Rub Collar RC201

PART	DIA.	d	H	h	L	R	BORE	PRICE
UP273	3-13/16	21/32	1-27/32	1-29/64	15/64	15/64	1-1/4	\$549.57
UP275	3-9/16	33/64	2-3/64	1-29/64	33/64	1/4	1-1/4	\$553.53

PART	DIA.	H	T	L	R	BORE	PRICE
EC274	2-27/32	1-31/32	15/64	nA	25/64	3/4	\$275.77
UP274	3-9/16	1-31/32	15/64	33/64	25/64	1-1/4	\$549.57

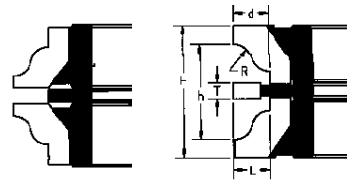
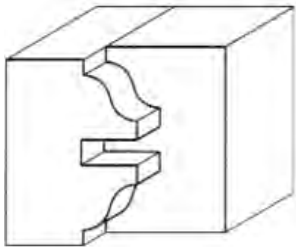

UP275 - Rub Collar RC201

PART	DIA.	d	H	h	T	R	BORE	PRICE
EC090	2-7/8	23/64	1-37/64	29/32	15/64	9/64	3/4	\$275.77
UP090	3-9/16	23/64	1-27/64	29/32	15/64	1/8	1-1/4	\$441.11

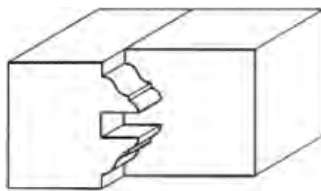

EC090
UP090

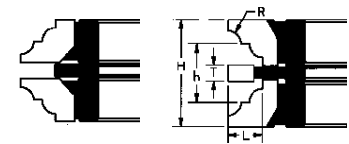
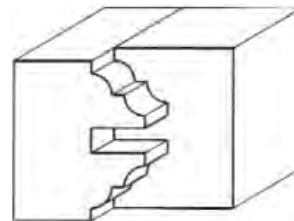
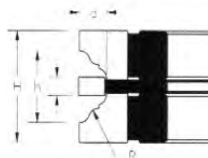

UP269

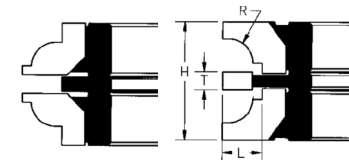
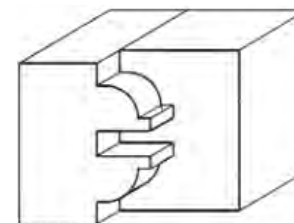

EC270 - Rub Collar RC001
UP270 - Rub Collar RC201

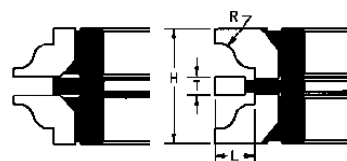
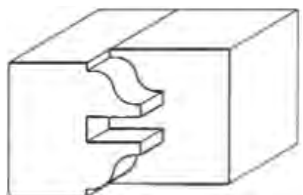

UP272 - Rub Collar RC201

FREUD

2 + 2 Raised Panel Cutter for 5/8" Stock

PART	DIA.	H	h	R	r	a°	BORE	RUB COLLAR	PRICE
UP200	5-1/2	5/8	15/64	1-29/32	--	--	1-1/4	RC101	\$149.14
UP201	5-1/2	5/8	23/64	nA	--	12°	1-1/4	RC101	\$149.14
UC202	4-15/16	33/64	--	1/8	--	12°	3/4	RC002	\$149.14
UP202	5-1/2	5/8	3/8	1/8	--	12°	1-1/4	RC101	\$149.14
UP203	5-1/2	5/8	3/8	1-9/16	1/8	--	1-1/4	RC101	\$149.14
UP204	5-1/2	5/8	5/32	9/16	--	7°	1-1/4	RC101	\$149.14
UP205	5-1/2	5/8	1/8	1/8	--	--	1-1/4	RC101	\$149.14
UP206	5-1/2	5/8	3/8	9/64	--	--	1-1/4	RC101	\$149.14
UP207	5-1/2	5/8	3/8	5/32	--	--	1-1/4	RC101	\$149.14
UP208	5-1/2	5/8	13/32	1-15/16	1-5/16	28°	1-1/4	RC101	\$149.14

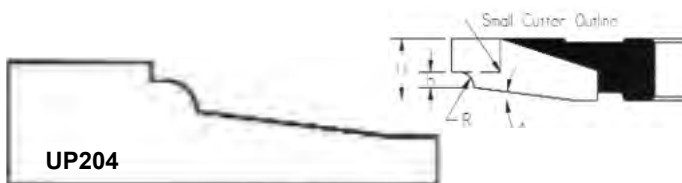
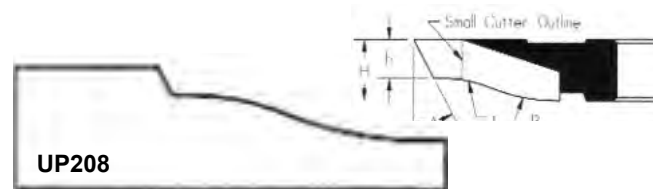
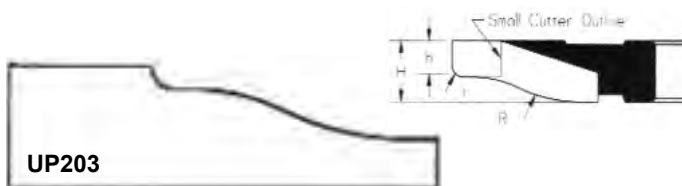
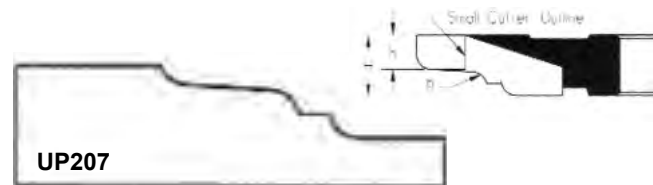
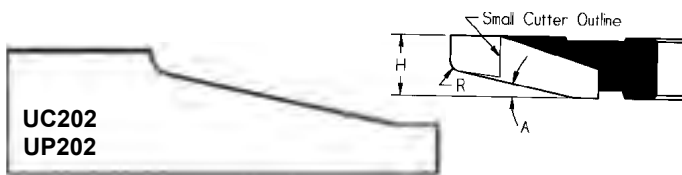
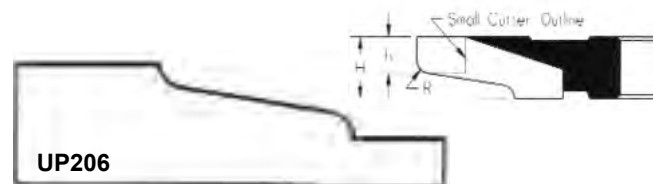
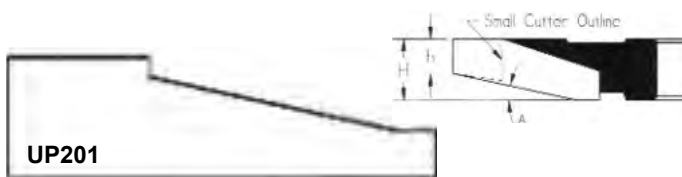
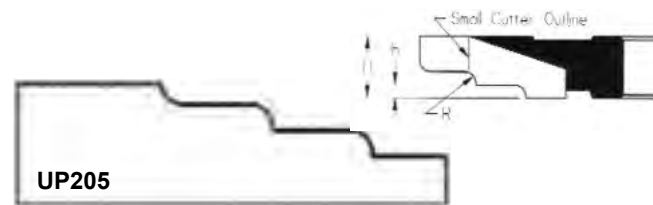
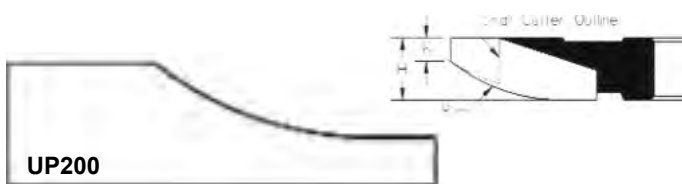

FREUD

2 + 2 Raised Panel Cutter for 3/4" Stock

PART	DIA.	H	h	R	r	a°	BORE	RUB COLLAR	PRICE
UC209	4-15/16	43/64	1/8	1-57/64	--	--	3/4	RC002	\$126.32
UP209	5-1/2	5/8	5/64	1-57/64	--	--	1-1/4	RC101	\$149.14
UC210	4-15/16	23/32	23/64	1-15/32	1/8	--	3/4	RC002	\$126.32
UP210	5-1/2	5/8	9/32	1-15/32	1/8	--	1-1/4	RC101	\$149.14
UC211	4-15/16	5/8	15/64	--	--	17°	3/4	RC002	\$126.32
UP211	5-1/2	5/8	15/64	--	--	17°	1-1/4	RC101	\$149.14
UC212	4-15/16	17/32	--	13/64	--	13°	3/4	RC002	\$126.32
UP212	5-1/2	5/8	--	13/64	--	13°	1-1/4	RC101	\$149.14
UC213	4-15/16	11/16	21/64	1-31/32	1-3/8	23°	3/4	RC002	\$126.32
UP213	5-1/2	5/8	9/32	1-31/32	1-3/8	23°	1-1/4	RC101	\$149.14
UP214	5-1/2	5/8	21/64	13/64	1/8	--	1-1/4	RC101	\$149.14
UP215	5-1/2	5/8	15/64	13/64	--	10°	1-1/4	RC101	\$149.14
UP216	5-1/2	5/8	1/4	9/64	--	--	1-1/4	RC101	\$149.14
UP217	5-1/2	5/8	15/64	11/64	9/64	7.5°	1-1/4	RC101	\$149.14
UP218	5-1/2	5/8	1/4	5/32	9/64	--	1-1/4	RC101	\$149.14

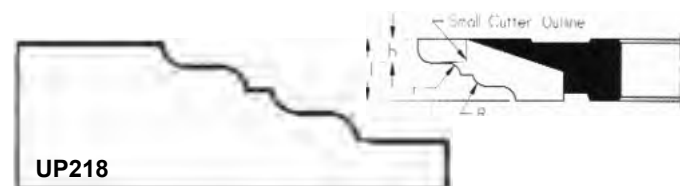
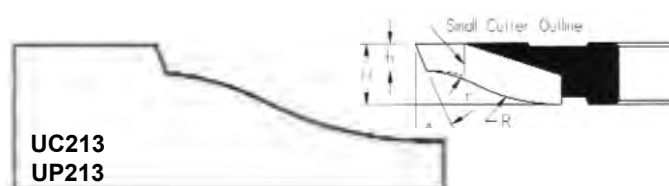
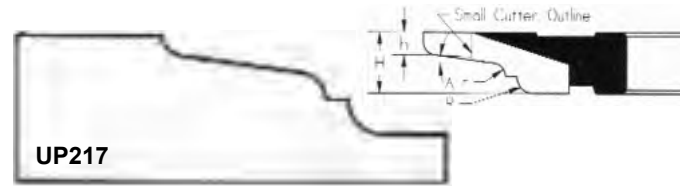
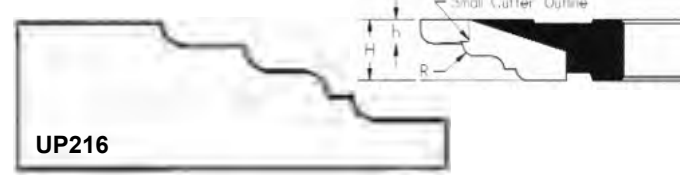
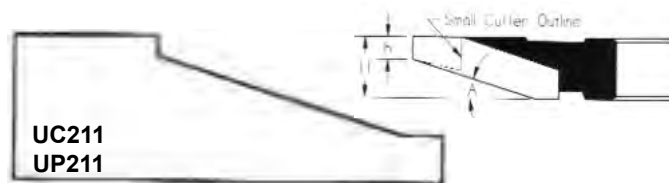
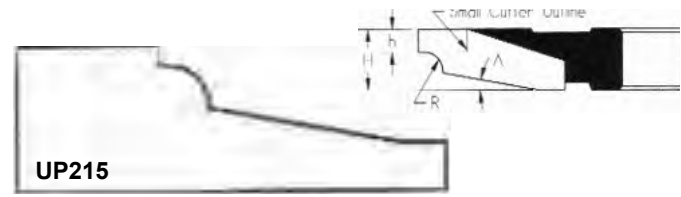
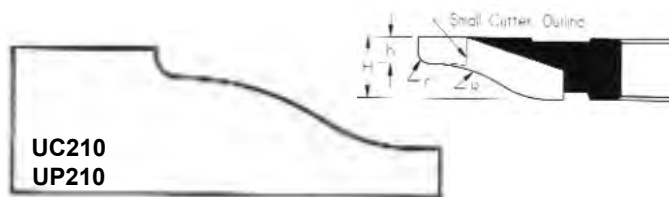
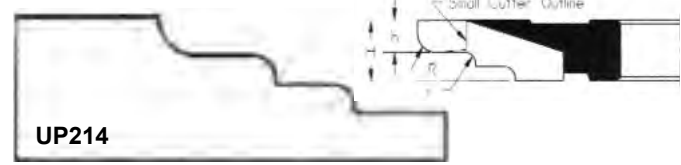
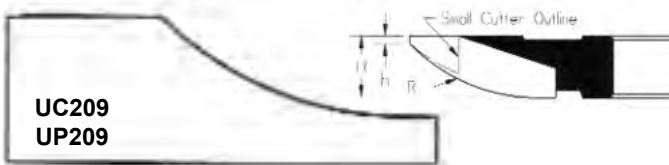

FREUD

2 + 2 Raised Panel Cutter for 3/4" Stock (cont.)

PART	DIA.	H	h	R	r	a°	BORE	RUB COLLAR	PRICE
UP219	5-1/2	5/8	9/32	1/8	--	--	1-1/4	RC101	\$149.14
UP220	5-1/2	5/8	15/64	9/32	5/32	--	1-1/4	RC101	\$149.14
UP221	5-1/2	5/8	15/64	9/64	1/8	4°	1-1/4	RC101	\$149.14
UP222	5-1/2	5/8	15/64	1/8	--	--	1-1/4	RC101	\$149.14
UP223	5-1/2	5/8	23/64	5/32	1/8	10°	1-1/4	RC101	\$149.14

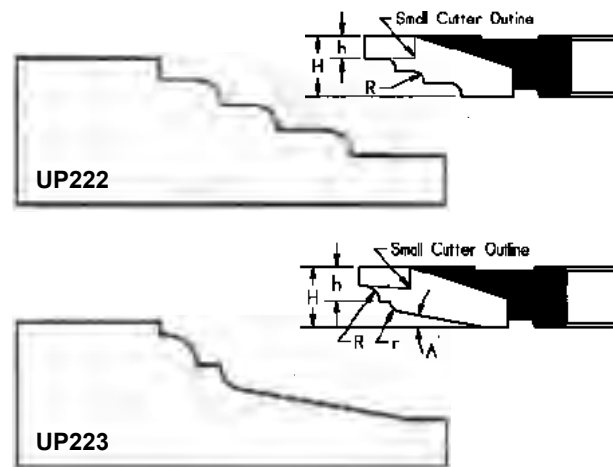
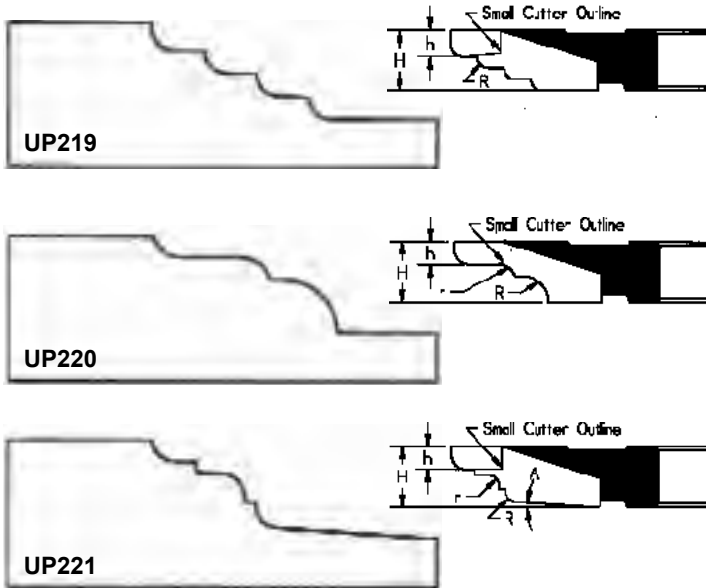

Back Cutters for Double Raised Panels

PART	DIA.	H	R	a°	BORE	PRICE
UP230	3-15/16	3/8	13/64	--	1-1/4	\$91.11
UP231	4-9/32	3/8	--	45°	1-1/4	\$95.31

Freud's back-cutters are designed to be used with Freud's 2+2 Raised Panel Cutters UP200 through UP208 when using 3/4" stock. These cutters leave a decorative groove on the back side of the panel making the panel flush with both the front and back of the rail and stiles.

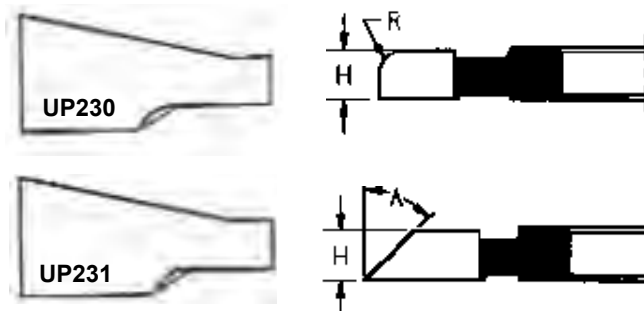

The "Duplex" Multi-Profile Raised Panel Cutter

PART	DIA.	d	H	h	R	r	a°	BORE	PRICE
FD72M	5-29/32	1-7/8	1-5/64	3/32	5/32	1/8	3.5°	1-1/4	\$248.54

The Duplex Raised Panel Cutter has the flexibility to allow you to create custom raised panel profiles with just one cutter. It can create eight different profiles using only one pass. Different profiles can be obtained by running the stock over or under the head and changing the height of the cutter. Three wing cutter.

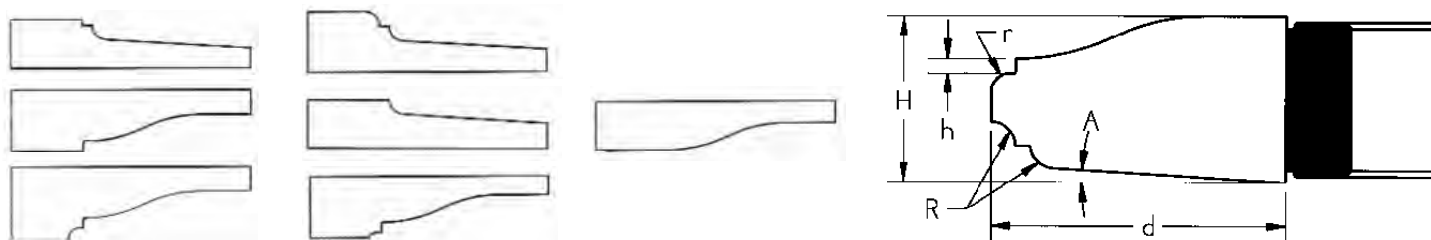

FREUD

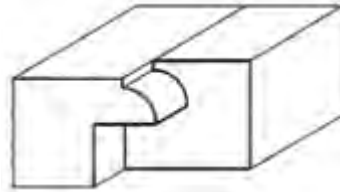
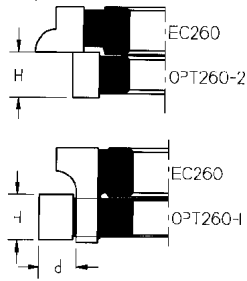

Glass Door Cutter for EC260, EC261, EC263

PART	DIA.	d	H	BORE	PRICE
OPT 260	2-53/64	7/16	15/32	3/4	\$71.89

Use this set of cutters with EC260, EC261, or EC263 to make rabbet required in the back of doors for glass panels. Secure glass in place with a small piece of molding. Three wing cutters. Profile cutters not included.



UC900 \$449.99

UC900 Raised Panel Door System

PART	TYPE	DIA.	CUT DEPTH	CARBIDE HEIGHT	TENON THICKNESS	TENON LENGTH	BORE
EC001	Door Lip	2-7/8	29/64	1-1/4	NA	NA	3/4
EC031	Glue Joint	2-7/8	5/32	1-17/64	NA	NA	3/4
UC210	Raised Panel	4-15/16	NA	23/32	15/64	NA	3/4
EC260	Stile , Rail	2-7/16	15/64	1	15/64	7/16	3/4

This one box contains all the cutters you need to make raised panel doors on your 3/4" shaper.

Included is a set of male and female rail and stile door cutters for making your rails and stiles, a door lip cutter for inset doors, a glue joint cutter for gluing up panels, and a 2+2 raised panel cutter with our most popular profile. All the cutters come packaged in a wooden storage case with necessary shims included.

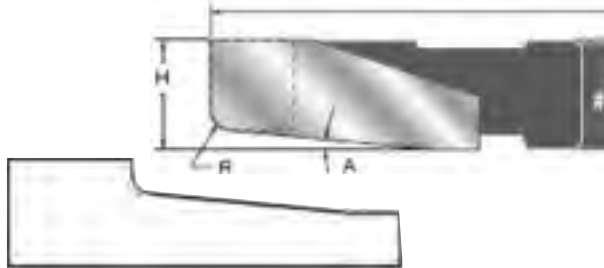

2+2 Raised Panel Cutter for Double-Sided Panels

PART	DIA.	d	H	ANGLE	BORE	PRICE
UP016	5-1/2	5/8	1/8	6°	1-1/4	\$146.79

The 2+2 Raised Panel cutter is ideal for double-sided raised panel interior and exterior doors.

Bearing Rub Collars

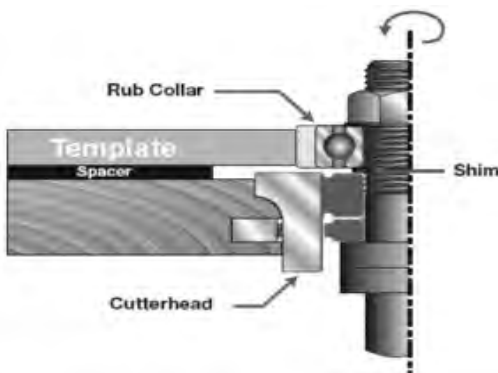



PART	OUTSIDE			PRICE
	DIA.	BORE		
RC401	3	1-1/4		\$57.82
RC501	3-1/2	1-1/4		\$57.82
RC601	3-1/4	3/4		\$51.17
RC701	4-9/16	1-1/4		\$66.78
RSC-3	85mm	1-1/4		\$60.83

PART	OUTSIDE			PRICE
	DIA.	BORE		
RC-001	48mm	3/4		\$51.17
RC-002	1-3/4	3/4		\$51.17
RC-003	72mm	3/4		\$51.17
RC201	2-1/2	1-1/4		\$57.82
RC301	2-3/4	1-1/4		\$57.82
RC302	2-3/4	1-1/8		\$56.70

FS TOOL STANDARD DADO SETS					
Standard set consists of two outside saw blades 1/8" kerf, one 1/4" chipper, two 1/8" chippers, and one 1/16" chipper.					
Part #	Diameter	Max. Width	Bore	Teeth	Price
53DL06	6"	13/16"	5/8"	24	\$233.55
53DL08	8"	13/16"	5/8"	24	\$234.94
53DL08-1	8"	13/16"	1"	24	\$234.94
53DL10	10"	13/16"	5/8"	24	\$335.77
53DL10-1	10"	13/16"	1"	24	\$335.77
53DL12	12"	13/16"	1"	24	\$452.67
53DL14	14"	13/16"	1"	40	\$652.78

FS TOOL SAFETY DADO SETS "Anti-Kickback" Design					
Standard set consists of two outside saw blades 1/8" kerf, one 1/4" chipper, two 1/8" chippers and one 1/16" chipper. Anti-kickback design reduces the risk of kickback.					
Part #	Diameter	Max. Width	Bore	Teeth	Price
53DL08S	8"	13/16"	5/8"	24	\$235.00

FS TOOL FINE DADO SETS					
Standard set consists of two outside saw blades 1/8" kerf, one 1/4" chipper, two 1/8" chippers, and one 1/16" chipper. Hook angle 0°.					
Part #	Diameter	Max. Width	Bore	Teeth	Price
54DL08	8"	13/16"	5/8"	40	\$326.38
54DL08-1	8"	13/16"	1"	40	\$326.38
54DL10	10"	13/16"	5/8"	60	\$414.60
54DL10-1	10"	13/16"	1"	60	\$414.60

SYSTI-MATIC STACKED DADO SETS							
		 <p>Chipper Blade</p>		<p>SYSTI-MATIC FINE DADO SET</p> <p>(2) 22T Outside Blades,</p> <p>(5) 2T Chipper Blades</p> <p>LIMITED TO STOCK ON HAND!!!</p>			
Part #	Diameter	Type	Teeth	Arbor	Chippers	Width	Price
10DS22 FINE 1	10"	DS-FINE	22	1"	(1) 1/16" (4) 1/8"	13/16"	\$205.97

FS Tool

SM6 30° XL4000 CHIP-FREE MELAMINE TRIM BLADES

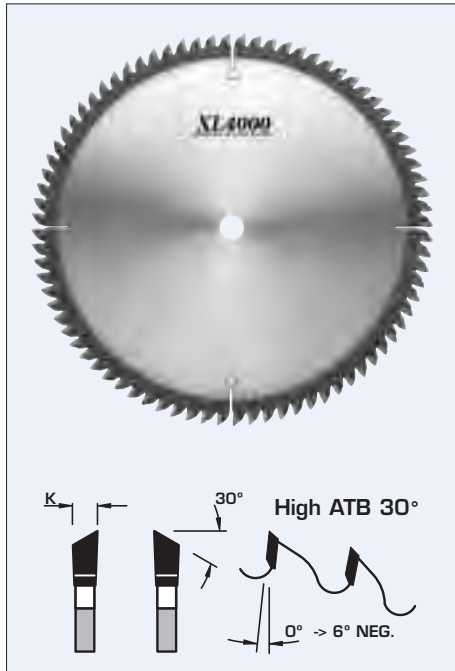

DESIGN:

- Tooth configuration: High ATB (30°)
- Cutting material: TC **XL4000**
- Expansion slots: Cu plugged

APPLICATION:

- For chip-free sizing cuts (on both sides) in melamine and wood veneered panels, without the need for pre-scoring
- For fine cross cuts in solid woods
- On table saws, sliding table saws, vertical panel sizing saws and cut-off saws

PART NO.	DIAM.	KERF	PLATE	BORE	TEETH	PRICE
SM6201	8"	.118"	.087"	5/8"	60	\$137.63
SM6221-H ▲	220mm	3.2mm	2.4mm	30mm	64	\$163.10
SM6251	10"	.118"	.087"	5/8"	80	\$165.58
SM6301-30 ●	300mm	3.2mm	2.4mm	30mm	100	\$205.20
SM6301	12"	.126"	.095"	1"	100	\$205.20
SM6352	14"	.150"	.118"	1"	100	\$230.00
SM6401	16"	.157"	.118"	1"	120	\$324.82

- ▲ Holz-Her, pin holes, 2/7/42
- Altendorf, Striebig

SM6 XL4000 MITRE JOINT SAW BLADES

DESIGN:

- Tooth configuration: 4 ATB & 1 raker
- Cutting material: TC **XL4000**
- Expansion slots: Cu plugged

APPLICATION:

- For mitre joint cuts in soft and hardwoods, painted mouldings, gesso and other high-gloss and pre-finished picture frames and furniture mouldings as well as P.V.C. substrates
- For aluminum cuts see L1A, L1B, L1C series page E36, E37
- On single or double cut-off mitre machines and radial arm saws

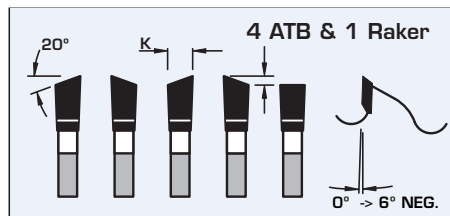

PART NO.	DIAM.	KERF	PLATE	BORE	TEETH	PRICE
SM6308 ▲	12"	.135"	.110"	5/8"	100	\$211.76

- ▲ Pistorius, CTD

FS Tool

SS1

XL4000 SOLID SURFACE SAW BLADES

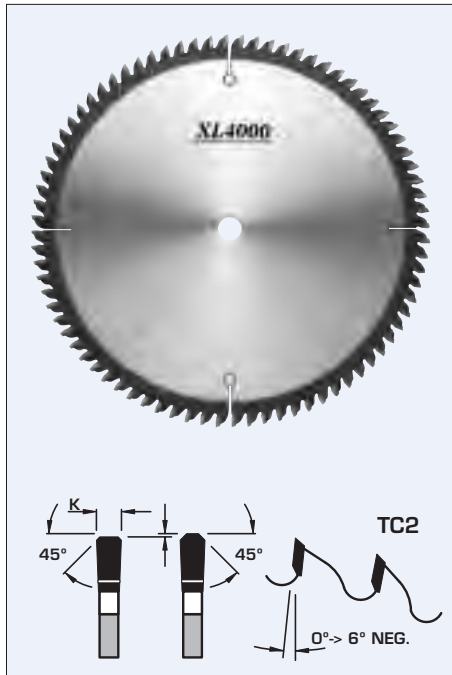

DESIGN:

- Tooth configuration: TC2
- Cutting material: TC *XL4000*
- Expansion slots: Cu plugged

APPLICATION:

- For fine sizing cuts in single or double laminated panels, plexiglass and solid surface materials such as Wilsonart® Gibraltar®, SSV®, Corian®, Surell®, Avonite®, Fountainhead®, etc.
- On table saws, sliding table saws, radial arm saws and vertical panel sizing saws

PART NO.	DIAM.	KERF	PLATE	BORE	TEETH	PRICE
SS1200	8"	.126"	.087"	5/8"	60	\$126.92
SS1220 ▲	220mm	3.4mm	2.4mm	30mm	64	\$163.10
SS1249	10"	.126"	.087"	5/8"	60	\$146.02
SS1250	10"	.126"	.087"	5/8"	80	\$165.92
SS1300-30 ●	300mm	3.4mm	2.4mm	30mm	100	\$199.54
SS1300	12"	.135"	.095"	1"	100	\$199.54
SS1350	14"	.158"	.118"	1"	100	\$240.60
SS1400	16"	.160"	.118"	1"	120	\$324.82
SS1450	18"	.185"	.138"	1"	120	\$398.10

- ▲ Holz-Her, pin holes 2/7/42
- Altendorf, Striebig

LNM

NON-MELT SAW BLADES

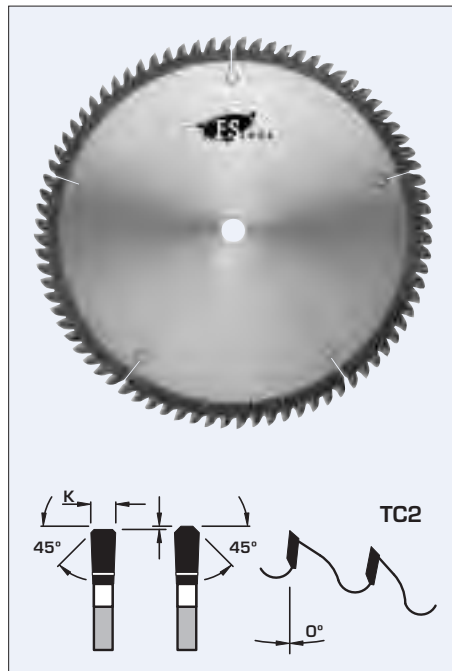

DESIGN:

- Tooth configuration: TC2
- Tooth geometry specifically designed to minimize "melting" of material
- Cutting material: TC
- Expansion slots: Cu plugged

APPLICATION:

- For "non-melt" fine cuts in acrylic sheets, selrins, ABS (cycolac), Styrenes and PVC
- On table saws, sliding table saws and vertical panel sizing saws

PART NO.	DIAM.	KERF	PLATE	BORE	TEETH	PRICE
LNM200	8"	.100"	.071"	5/8"	60	\$111.43
LNM250	10"	.100"	.071"	5/8"	80	\$156.80
LNM300	12"	.125"	.095"	1"	100	\$192.31
LNM350	14"	.145"	.118"	1"	100	\$231.41

- ▲ Holz-Her, pin holes 2/7/42

FS Tool

LM4/LM6 MITRE JOINT SAW BLADES

DESIGN:

- Tooth configuration: 4 ATB & 1 raker
- Cutting material: TC
- Expansion slots: Cu plugged

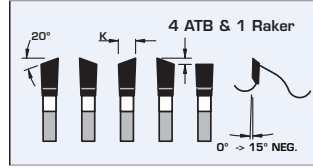

APPLICATION:

- For mitre joint cuts in soft and hardwoods, painted mouldings, gesso and other high-gloss and pre-finished picture frames and furniture mouldings as well as P.V.C. substrates
- For aluminum cuts see L1A, L1B, L1C series page E36, E37
- On single or double cut-off mitre machines and radial arm saws



PART NO.	DIAM.	KERF	PLATE	BORE	TEETH	PRICE
LM4250	10"	.116"	.087"	5/8"	60	\$116.13
LM6358 (b)	14"	.150"	.118"	5/8"	100	\$218.52

(b) Pistorius, CTD

LM6 30° CHIP-FREE MELAMINE TRIM BLADES

DESIGN:

- Tooth configuration: High ATB (30°)
- Cutting material: TC
- Expansion slots: Cu plugged

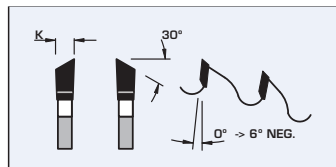

APPLICATION:

- For chip-free sizing cuts (on both sides) in melamine and wood veneered panels, without the need for pre-scoring
- For fine cross cuts in solid woods
- On table saws, sliding table saws, vertical panel sizing saws and cut-off saws

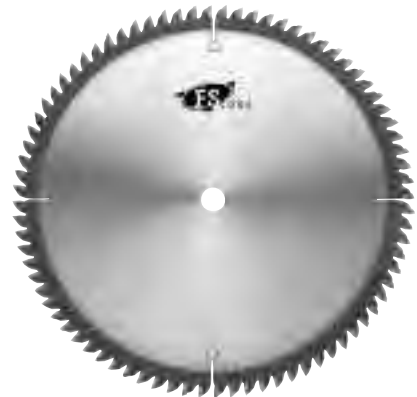

PART NO.	DIAM.	KERF	PLATE	BORE	TEETH	PRICE
LM6251	10"	.118"	.087"	5/8"	80	\$145.31
LM6301-30 ●	300mm	3.2mm	2.4mm	30mm	100	\$191.58
LM6301	12"	.126"	.095"	1"	100	\$180.17
LM6352	14"	.150"	.118"	1"	100	\$201.87

▲ Holz-Her, pin holes, 2/7/42 ● Altendorf, Striebig

5G GROOVING SAW BLADES

DESIGN:

- Tooth configuration: Flat Top
- Cutting material: TC

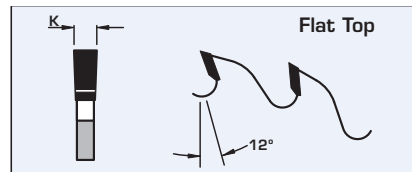

APPLICATION:

- For cutting grooves in solid wood, plywood, veneered and plastic laminated panels
- On table saws, sliding table saws, single or double end tenoners and CNC routers



PART NO.	DIAM.	KERF	PLATE	BORE	TEETH	PRICE
5G6014	6"	1/4"	.180"	5/8"	12	\$188.56

FS Tool

S06 XL4000 FINE CROSS CUT SAW BLADES

DESIGN:

- Tooth configuration: ATB
- Cutting material: TC *XL4000*
- Expansion slots: Cu plugged

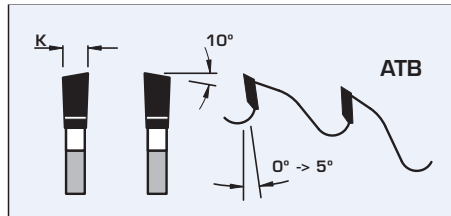

APPLICATION:

- For fine cut-off and trimming of soft and hardwoods, plywood, wood veneered and plastic laminated panel materials
- On table saws, sliding table saws and cut-off saws

PART NO.	DIAM.	KERF	PLATE	BORE	TEETH	PRICE
S06400CT ▲	16"	.160"	.118"	1"	120	\$284.57

▲ Specifically designed for cutting kitchen counter tops



S10 XL4000 FINE CROSS CUT SAW BLADES

DESIGN:

- Tooth configuration: TCG
- Cutting material: TC *XL4000*
- Expansion slots: Cu plugged

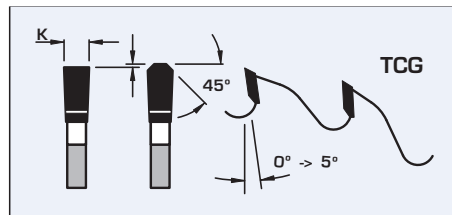

APPLICATION:

- For fine sizing cuts in single or double sided melamine panels, MDF, OSB and HDF panels
- On table saws, sliding table saws and vertical panel sizing saws

PART NO.	DIAM.	KERF	PLATE	BORE	TEETH	PRICE
S10220-H ▲	220mm	3.2mm	2.2mm	30mm	64	\$149.04

▲ Holz-Her, pin holes 2/7/42



S23 XL4000 STANDARD CROSS CUT SAW BLADES

DESIGN:

- Tooth configuration: TCG
- Cutting material: TC *XL4000*
- Expansion slots: Cu plugged

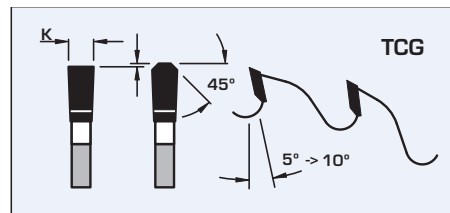

APPLICATION:

- For general cut-off and trimming of plastic laminated materials (single sided), or (double sided) using a pre-scoring unit
- On table saws, sliding table saws and cut-off saws

PART NO.	DIAM.	KERF	PLATE	BORE	TEETH	PRICE
S23350	14"	.150"	.110"	1"	80	\$200.27
S23302 ▲	300mm	3.4mm	2.4mm	30mm	72	\$174.43
S23300	12"	.135"	.095"	1"	80	\$172.52

▲ Altendorf, Omega, SCMI, Striebig



FS Tool

S22 XL4000 GLUE LINE RIP SAW BLADES

DESIGN:

- Tooth configuration: TCG
- Cutting material: TC *XL4000*
- Expansion slots: Cu plugged

APPLICATION:

- For glue line ripping dry soft and hardwoods
- Extra smooth cut for gluing applications
- On straight line rip saws, gang rip saws and table saws

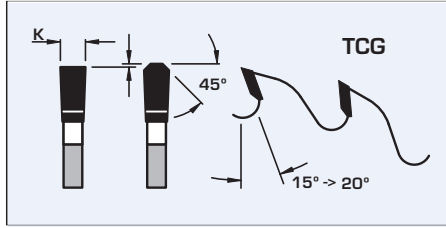

PART NO.	DIAM.	KERF	PLATE	BORE	TEETH	PRICE
S22306-2 ▲	12"	.160"	.110"	2"	36	\$148.26
S22350-2 ▲	14"	.169"	.118"	2"	36	\$167.05

▲ Diehl with 9/16" pin-hole

L1A SAW BLADES FOR NON-FERROUS METALS

DESIGN:

- Tooth configuration: TCG
- Cutting material: TC
- Expansion slots: Cu plugged

APPLICATION:

- For splitting and mitre jointing non-ferrous extrusions, sheets and light bars
- On mitre joint, splitting, trimming, double cross-cutting and sizing machines
- Material to be cut must be clamped firmly
- Use of spray lubrication recommended

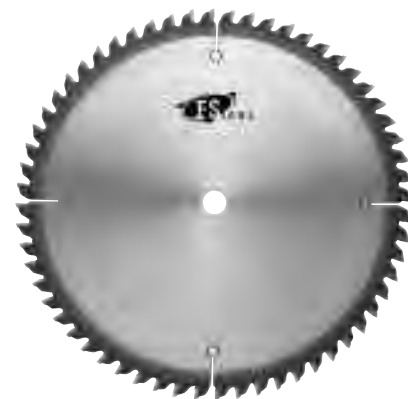
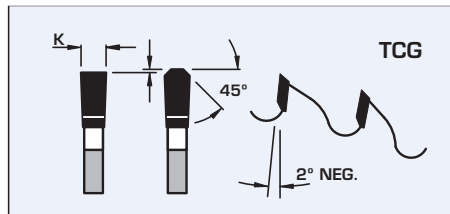

PART NO.	DIAM.	KERF	PLATE	BORE	TEETH	PRICE
L1A180	7"	.112"	.087"	5/8"	44	\$95.21

L1B SAW BLADES FOR NON-FERROUS METALS

DESIGN:

- Tooth configuration: TCG
- Cutting material: TC
- Expansion slots: Cu plugged

APPLICATION:

- For splitting and mitre jointing thin non-ferrous extrusions, thin sheets and light non-ferrous bars
- On mitre joint, splitting, trimming, double cross-cutting and sizing machines
- Material to be cut must be clamped firmly
- Use of spray lubrication recommended

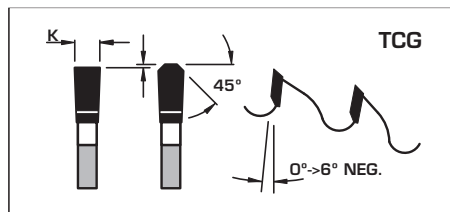

PART NO.	DIAM.	KERF	PLATE	BORE	TEETH	PRICE
L1B350	14"	.145"	.118"	1"	100	\$210.63
L1B500	20"	.174"	.138"	1"	120	\$352.57

FS Tool

527 XL4000 CONIC SCORING SAW BLADES

DESIGN:

- Tooth configuration: Conic
- Cutting material: TC *XL4000*
- Expansion slots: Cu plugged

APPLICATION:

- For pre-scoring in plastic laminated sheets
- On panel sizing saws with pre-scoring units

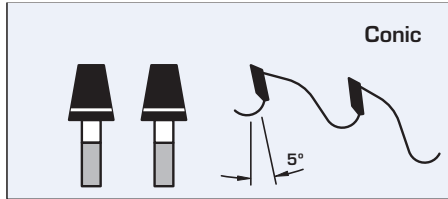

PART NO.	DIAM. mm	KERF mm	PLATE mm	BORE mm	TEETH	MACHINE	PRICE
52715003	150	4.4/5.4	3.0	30	24	Irion, Mayer	\$134.76
52715003-114	150	4.4/5.4	3.0	1-1/4"	24	SCMI	\$134.76
52716003	160	4.4/5.4	3.2	45 _{3PH}	28	Giben Prismatic	\$142.63
52720001-20	200	4.4/5.4	3.0	20	34	Schelling	\$154.05

528 SPLIT SCORING SAW BLADES

DESIGN:

- Tooth configuration: Flat Top
- Cutting material: TC
- Two piece unit adjustable to the kerf of the main saw blade with the use of shims

APPLICATION:

- For pre-scoring in plastic laminated sheets
- On table saws, sliding table saws and panel sizing saws with controllable pre-scoring units

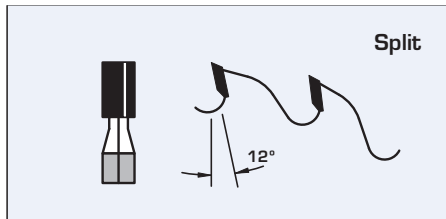

PART NO.	DIAM. mm	KERF mm	PLATE mm	BORE	TEETH	MACHINE	PRICE
528080001- 20	80	2.8/3.6	2.0	20	2x10	EMA Casadei, Minimax	\$119.70
52810001- 20	100	2.8/3.6	2.0	20	2x12	Schelling	\$119.70
52812001- 34	120	2.8/3.6	2.0	3/4"	2x12	SCMI	\$123.93
52812001- 20	120	2.8/3.6	2.0	20	2x12	SCM, Holz-Her	\$154.05
52812001-50 ▲	120	2.8/3.6	2.2	50	2x12	Altendorf - Rapido	\$139.99

▲ 50mm bore, 4 pin-holes counter-sunk, no shims required.
For Altendorf with RAPIDO adjustable flange

L01 FINE CROSS CUT SAW BLADES FOR PLASTIC

DESIGN:

- Tooth configuration: TC2
- Cutting material: TC
- Expansion slots: Cu plugged

APPLICATION:

- For fine sizing cuts in single or double laminated panels, plexiglass and solid surface materials such as Wilsonart® Gibraltar®, SSV®, Corian®, Surell®, Avonite®, Fountainhead®, etc.
- On table saws, sliding table saws, radial arm saws and vertical panel sizing saws
- "Non-Melt" saw blades see LNM series pg. E22

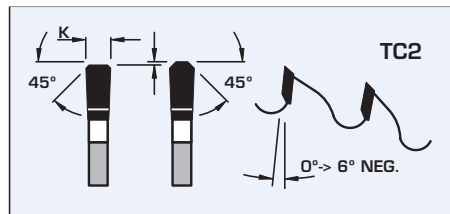

PART NO.	DIAM.	KERF	PLATE	BORE	TEETH	PRICE
L01250	10"	.126"	.087"	5/8"	80	\$145.31

FS Tool

L03 CROSS CUT SAW BLADES

DESIGN:

- Tooth configuration: ATB
- Cutting material: TC
- Expansion slots: Cu plugged

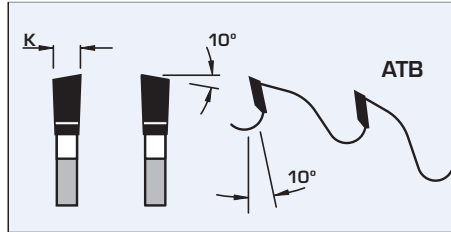

APPLICATION:

- For cross cutting and ripping dry soft and hardwoods, plywood, masonite and raw MDF panels
- On table saws, sliding table saws and cut-off saws



PART NO.	DIAM.	KERF	PLATE	BORE	TEETH	PRICE
L03250	10"	.125"	.087"	5/8"	40	\$88.84

L04 STANDARD CROSS CUT SAW BLADES

DESIGN:

- Tooth configuration: ATB
- Cutting material: TC
- Expansion slots: Cu plugged

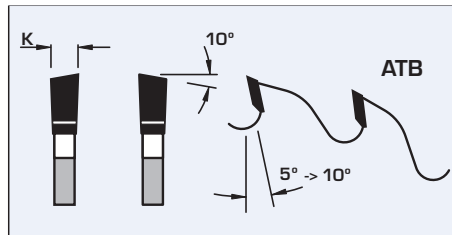

APPLICATION:

- For general cut-off and trimming of soft and hardwoods, plywood and composite panel materials, wood veneered (single sided), or (double sided) using a pre-scoring unit
- On table saws, sliding table saws and cut-off saws



PART NO.	DIAM.	KERF	PLATE	BORE	TEETH	PRICE
L04250	10"	.126"	.087"	5/8"	60	\$92.10
L04450	18"	.185"	.138"	1"	100	\$269.98
L04500	20"	.185"	.138"	1"	120	\$335.30

L06 FINE CROSS CUT SAW BLADES

DESIGN:

- Tooth configuration: ATB
- Cutting material: TC
- Expansion slots: Cu plugged

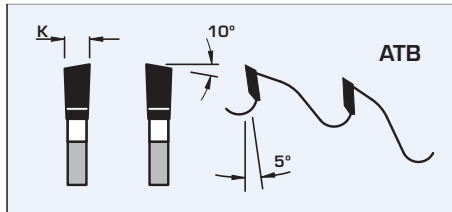

APPLICATION:

- For fine cut-off and trimming of soft and hardwoods, plywood, wood veneered and plastic laminated panel materials
- On table saws, sliding table saws and cut-off saws



PART NO.	DIAM.	KERF	PLATE	BORE	TEETH	PRICE
L06350	14"	.150"	.110"	1"	100	\$191.66

FS Tool

L09

CROSS CUT SAW BLADES

DESIGN:

- Tooth configuration: ATB
- Cutting material: TC
- Expansion slots: Cu plugged

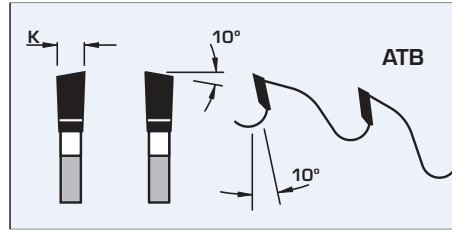

APPLICATION:

- For cross cutting and ripping soft and hardwoods, plywood, masonite and raw MDF panels
- On table saws, sliding table saws and cut-off saws

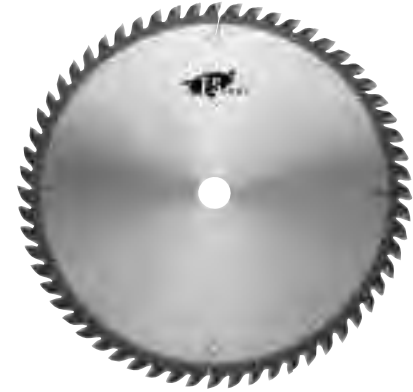

PART NO.	DIAM.	KERF	PLATE	BORE	TEETH	PRICE
L09200	8"	.125"	.095"	1"	40	\$93.26

L12

GANG RIP SAW BLADES WITH CHIP LIMITERS

DESIGN:

- Tooth configuration: Flat Top
- Cutting material: TC
- Expansion slots: Cu plugged
- Saw body with chip thickness limiters

APPLICATION:

- For ripping dry soft and hardwoods
- On gang-rip saws

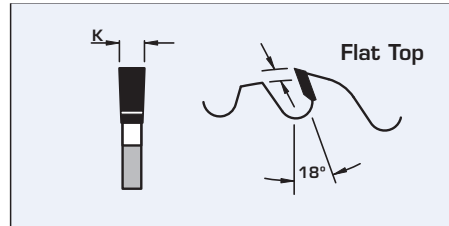

PART NO.	DIAM.	KERF	KEYWAY	BORE	TEETH	PRICE
L12300	300mm	3.2mm	2/20x5	70mm	28	\$120.87

Plate Thickness = 2.2mm

L21

STANDARD RIP SAW BLADES

DESIGN:

- Tooth configuration: Flat Top
- Cutting material: TC
- Expansion slots: Cu plugged

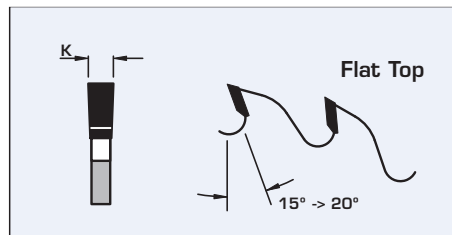

APPLICATION:

- For ripping dry soft and hardwoods
- On table saws or gang-rip saws with one or two shafts



PART NO.	DIAM.	KERF	PLATE	BORE	TEETH	PRICE
L21250	10"	.142"	.095"	5/8"	24	\$83.72

FS Tool

L23 STANDARD CROSS CUT SAW BLADES

DESIGN:

- Tooth configuration: TCG
- Cutting material: TC
- Expansion slots: Cu plugged

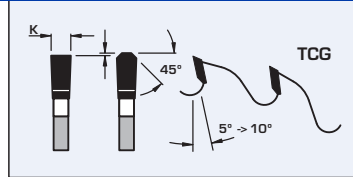

APPLICATION:

- For general cut-off and trimming of plastic laminated materials (single sided), or (double sided) using a pre-scoring unit
- On table saws, sliding table saws and cut-off saws

PART NO.	DIAM.	KERF	PLATE	BORE	TEETH	PRICE
L23250	10"	.126"	.087"	5/8"	60	\$94.12
L23302 ▲	300mm	3.4mm	2.4mm	30mm	72	\$151.52
L23408 ●	16"	.187"	.134"	1"	100	\$287.68
L23500	20"	.185"	.138"	1"	120	\$355.21

- ▲ Altendorf, Omega, SCMI, Striebig
- Midwest Automation

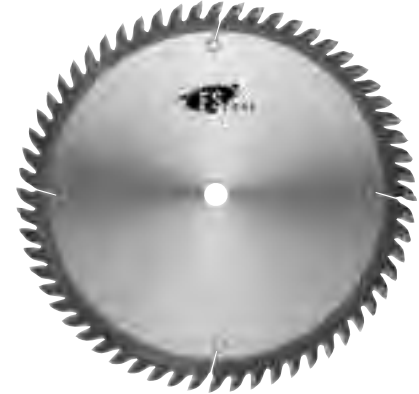

L42 HOLLOW FACE SAW BLADES

DESIGN:

- Tooth configuration: inverted "V" (face hollow-ground)
- Cutting material: TC
- Expansion slots: Cu plugged

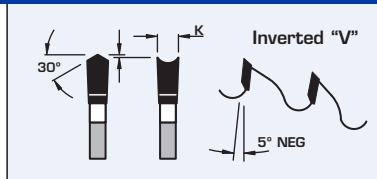

APPLICATION:

- For exceptionally smooth cuts (on both sides) in melamine and other laminated panels, without the need for pre-scoring
- For mitre cuts in wrapped styrene picture frames
- On table saws, sliding table saws, vertical panel sizing saws and mitre saws

PART NO.	DIAM.	KERF	PLATE	BORE	TEETH	PRICE
L42220-H ▲	220mm	3.2mm	2.2mm	30mm	42	\$145.67
L42300	300mm	3.2mm	2.2mm	1"	60	\$187.47

- ▲ Holz-Her, Striebig, pin holes 2/7/42

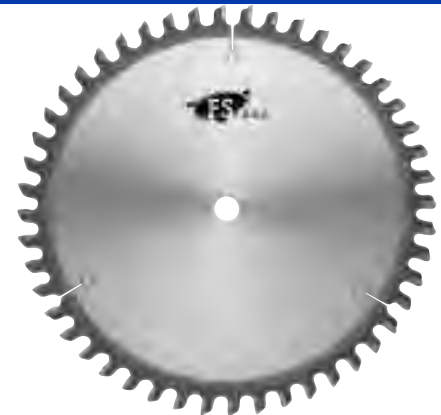

L50 XL4000 PANEL SIZING SAW BLADES

DESIGN:

- Tooth configuration: ATB
- Cutting material: TC **XL4000**
- Expansion slots: Cu plugged

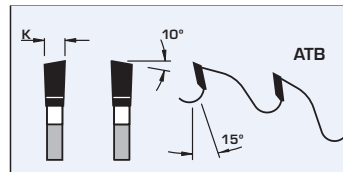

APPLICATION:

- For sizing cuts in veneered particleboard, hard fiberboard, raw MDF panels and high-density plywood in single sheets and stacks
- On panel sizing saws (Beam Saws)

PART NO.	DIAM. mm	KERF mm	PLATE mm	BORE mm	TEETH	MACHINE	PRICE
L5035072-30	355	4.4	3.0	30	72	SCM, Panhans, Mayer, Schelling	\$209.32



FS Tool

L55 COMBINATION SAW BLADES

DESIGN:

- Tooth configuration: 4 ATB & 1 Raker
- Cutting material: TC
- Four ATB teeth and one raker with deep gullet allow for deeper cuts and improved chip-flow

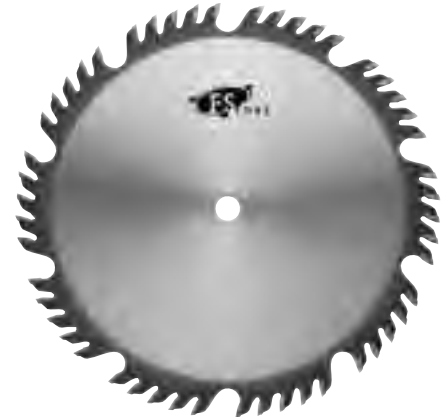
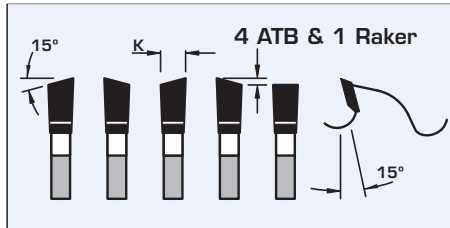

APPLICATION:

- For cross cutting and ripping soft and hardwoods, plywood and particleboard
- On table saws, sliding table saws and cut-off saws

PART NO.	DIAM.	KERF	PLATE	BORE	TEETH	PRICE
L55250	10"	.138"	.095"	5/8"	50	\$85.74

L52 XL4000 PANEL SIZING SAW BLADES

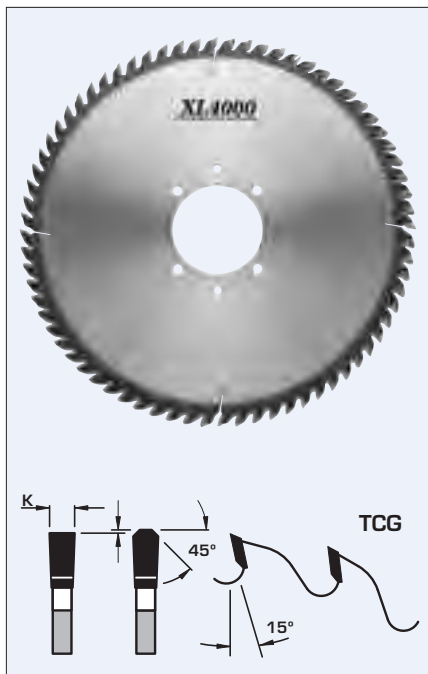

DESIGN:

- Tooth configuration: TCG
- Cutting material: TC **XL4000**
- Expansion slots: Cu plugged

APPLICATION:

- For sizing cuts in plastic laminated panels and plywood in single sheets and stacks
- On panel sizing saws (Beam Saws)

PART NO.	DIAM. mm	KERF mm	PLATE mm	BORE mm	TEETH	MACHINE	PRICE
L5230060-30	305	4.4	3.0	30	60	Mayer, Panhans	\$186.03
L5230072-80	300	4.4	3.0	80 _{2PH}	72	SCM Sigma 65	\$206.29
L5235072-30	355	4.4	3.0	30	72	SCM, Panhans, Mayer, Schelling	\$220.26
L5235072-114	350	4.4	3.0	1-1/4"	72	SCMI	\$220.26
L5235072-80	350	4.4	3.0	80 _{4/2PH}	72	Gabbiani Casadei	\$226.90
L5238072-60	380	4.4	3.2	60 _{2PH}	72	Holzma	\$252.44
L5240072-30	400	4.4	3.2	30	72	Schelling, Mayer, Irion	\$243.55
L5240072-75	400	4.4	3.2	75	72	Giben	\$243.55
L5240172-75	400	4.4	3.2	75 _{4PH}	72	Giben Prismatic-1	\$250.19
L5240072-80	400	4.4	3.2	80 _{4/2PH}	72	Gabbiani	\$250.19
L5250872-60	500	4.8	3.5	60	72	Holzma Type 22	\$342.60

GLOBAL

Planer & Jointer Knife Sets

Length	Width	Thickness	V2-HSS Set Price / Part #	Carbide Tipped Set Price / Part #	Knives in Set	Fits Planer / Jointer
4"	5/8"	1/8"	\$9.04 SVB4625125	\$46.58 SBC4625125	3	Atlas, Boice Crane, Old Craftsman, Jet JJ-4 & Similar Jointers
4-1/8"	11/16"	1/16"	\$29.70 SVB41256880625	N/A	3	Craftsman 113.21862
4-1/8"	7/8"	1/8"	\$40.26 SVB4125875125	N/A	2	Older Craftsman 149.236220, 149.236221, 149.236223 (3 Slotted Holes)
4-1/4"	3/4"	1/8"	\$11.63 SVB42575125	N/A	3	Older Craftsman Jointer
4-3/8"	5/8"	1/8"	\$11.63 SVB43756255125	N/A	3	Older Craftsman Jointer 103.23220
4-3/8"	11/16"	1/8"	\$13.20 SVB4375688125	\$53.89 SBC4375688125	3	Older Craftsman Jointer 103.20670, 103.21820, 103.23340
5-3/16"	7/8"	2mm	\$43.07 SVB519875078	N/A	2	Older Craftsman Jointer 149.236320 (3 Slotted Holes)
6"	5/8"	1/8"	\$12.56 SVB6625125	\$70.14 SBC6625125	3	Delta 6", TTL, Boice Crane, Craftsman, Rockwell, Jet JJ-6 Sunhill, Woodtek, Most Imports
6"	5/8"	1/8"	\$16.76 SVB6625125-4	N/A	4	Boice Crane
6"	16.5mm	2.7mm	\$23.50 PKH-14803	N/A	3	6" Delta 37-195, Delta 37-275X & Delta 37-190
6"	3/4"	1/8"	\$14.97 SVB675125	\$70.64 SBC675125	3	Powermatic 50, Crescent, Atlas
6"	1"	1/8"	\$19.85 SVB61125	\$71.41 SBC61125	3	Gri ly G6697
6-1/16"	5/8"	1/8"	\$12.90 SVB6-1/1662512	\$71.21 SBC6062625125	3	Older Powermatic 54A (No Holes), Jet JJ-6
6-1/16"	3/4"	1/8"	\$16.86 SVB6-1/1675125	\$70.64 SBC6-1/1675125	3	Delta, Walker-Tuner, Wallace
6-1/16"	13/16"	1/8"	\$16.45 SVB6062812125	\$71.41 SBC6062812125	3	Delta DJ-15, 37-154 & Similar 6" Jointers
6-1/16"	7/8"	5/64"	\$59.81 PKH-14813	N/A	3	6" Newer Powermatic 54A & Jet JJ-6CSDX (Double Edge, with Holes)
6-1/8"	5/8"	3/32"	\$12.95 SVB6125625093	N/A	3	Delta 37-658, 37-205, 37-220, 37-195, 37-190 Jointers, Rockwell 37-280
6-1/8"	5/8"	1/8"	\$12.95 SVB6125625125	N/A	3	Craftsman
6-1/8"	11/16"	1/8"	\$13.91 SVB6125688125	\$74.68 SBC6125688125	3	Jet, Ridgid JP0610
6-3/16"	7/8"	1/16"	\$20.36 PKH-14801	N/A	2	6" Delta 37-070 & Delta JT160 (with Holes)
6.22"	7/8"	0.070"	\$16.50 PKH-14815	N/A	2	6" Craftsman 351.217880 & 351.286300 (with Holes)
8"	5/8"	1/8"	\$17.72 SVB8625125	\$93.42 SBC8625125	3	Delta 8", TTL, Boice Crane, Rockwell, Powermatic 60, Jet JJ-8, Woodtek, Most Imports
8"	3/4"	1/8"	\$20.03 SVB875125	\$93.93 SBC875125	3	Jet JJ-8 Jointer, Powermatic 60, Pryor, Sunhill
8"	3/4"	1/8"	\$26.68 SVB875125-4	\$126.60 SBC875125B	4	Bridgewood, Gri ly 8"
8"	7/8"	1/8"	\$22.94 SVB8875125	\$94.45 SBC8875125	3	Older Powermatic 60
8"	1"	1/8"	\$26.57 SVB81125	\$94.96 SBC81125	3	Gri ly G6698, Oliver, Shop Fox W1684
8-1/16"	5/8"	3/32"	\$17.08 SVB80626093	N/A	3	Delta 37-315, ates, J-Line
8-1/16"	5/8"	1/8"	\$17.08 SVB8-1/16625125	N/A	3	Delta

GLOBAL Planer & Jointer Knife Sets

Length	Width	Thickness	V2-HSS Set Price / Part #	Carbide Tipped Set Price / Part #	Knives in Set	Fits Planer / Jointer
8-1/16"	3/4"	1/8"	\$20.31 SVB8-1/1675125	\$95.52 SBC8-1/1675125	3	Sunhill Machinery
8-1/16"	13/16"	1/8"	\$21.95 SVB8062812125	\$94.96 SBC8062812125	3	Delta DJ-20, 37-365 & Similar
10-1/4"	11/16"	1/8"	\$19.21 SVB10687125-2	N/A	2	Grizzly G0675, Central Machine S-6935
11-13/16" 300mm	25/32" 20mm	1/8" 3mm	\$48.84 SVB1278118	N/A	2	Logosol PH260
12"	5/16"	5/64"	\$44.35 PKH-12832	N/A	2	12" Makita Model 2012 (Double Edge)
12"	15/32"	1/16"	\$31.33 PKH-12804	N/A	2	12" Craftsman 21722, Central Machinery 95082 (Double Edge)
12"	3/4"	1/8"	\$29.96 SVB1275125	N/A	3	Grizzly G6700
12"	7/8"	1/8"	\$34.22 SVB12875125	\$141.54 SBC12875125	3	Powermatic 100, Parks, Woodtek
12"	1"	1/8"	\$39.72 SVB121125	\$142.56 SBC121125	3	Craftsman
12"	1-1/4"	1/8"	\$49.10 SVB12125125	\$144.11 SBC12125125	3	Northfield, Oliver, Powermatic 1285
12-1/4"	3/4"	1/8"	\$30.56 SVB122575125	N/A	3	Boice Crane, Reliant, Wilke
12-1/4"	7/8"	1/8"	\$35.10 SVB1225875125	\$144.11 SBC1225875125	3	Powermatic 100
12-1/4"	1"	1/8"	\$40.59 SVB12251125	\$145.40 SBC12251125	3	Parks, Boice, Most European Combo Machines
12-15/32"	3/4"	1/16"	\$45.44 PKH-12810	N/A	2	12" Delta 22-540 & TP300 (Double Edge)
12-1/2"	15/32"	1/16"	\$47.01 PKH-12803	N/A	2	12-1/2" Delta 22-560, 22-565, TP305, TP400LS, Ryobi AP-12, Craftsman 21758, Grizzly G0663, Performax 240-3749, Porter Cable PC305TP, Powertec PL1250 (Double Edge)
12-1/2"	5/8"	1/8"	\$26.22 SVB12562525	N/A	3	Boice Crane
12-1/2"	11/16"	1/8"	\$28.33 SVB1250687125	\$146.16 SBC1250687125	3	RBI Model 812, Foley-Belsaw, Woodmaster 712, Jet
12-1/2"	45/64"	1/8"	\$45.59 PKH-12818	N/A	2	12-1/2" Craftsman 233780, Wilton 99178 & 34463, Rockwell RK9018, Jet 708813, JWP-12DX (Double Edge)
12-1/2"	3/4"	1/8"	\$26.38 SVB125075125-2	\$97.76 SBC125075125-2	2	Jet 708522, JWP 12-4P, Craftsman 233780
12-1/2"	3/4"	1/8"	\$31.23 SVB125075125	\$146.65 SBC125075125	3	Jet, Grizzly G1195, Wilke, Reliant, & Most 12" Imports
12-1/2"	7/8"	1/16"	\$59.55 PKH-12801	N/A	3	12-1/2" DeWalt DW734 (Double Edge, with Holes)
12-1/2"	1-1/16"	1/8"	\$53.28 PKH-12809	N/A	2	12-1/2" DeWalt DW733 (with Holes & Slots)
13"	1/2"	1/16"	\$28.20 PKH-12806	N/A	2	13" Ryobi AP1300, Order 2 Sets for 3 Knife Craftsman Model 21748 & 3 Knife Masterforce Model 2400045 (Double Edge, with Holes)
13"	3/4"	1/16"	\$43.87 PKH-12807	N/A	2	13" Ridgid TP1300 (Double Edge)
13"	3/4"	1/16"	\$43.87 PKH-12826	N/A	2	13" Ryobi AP1301 (Double Edge)
13"	7/8"	1/16"	\$62.68 PKH-12800	\$170.94 PKH-12800-C	3	13" DeWalt DW735 (HSS is Double Edge, Carbide Tipped is Single Edge, with Holes)
13-1/16"	5/8"	1/8"	\$27.70 SVB13062625125	\$152.28 SBC13063625125	3	Jet
13.071" 332mm	0.866" 22mm	0.065" 1.66mm	\$47.01 PKH-13100	N/A	2	13" Craftsman 351.217130 & 351.275190 (Double Edge, with Holes)
13-1/8"	15/32"	1/16"	\$47.01 PKH-12802	N/A	2	13" Delta 22-580, Grizzly G0689 (Double Edge, with Holes)

GLOBAL Planer & Jointer Knife Sets

Length	Width	Thickness	V2-HSS Set Price / Part #	Carbide Tipped Set Price / Part #	Knives in Set	Fits Planer / Jointer
13-1/8"	15/32"	1/16"	\$63.95 PKH-12827	N/A	3	13" Delta 22-590, Steel City Model 40220 (Double Edge, with Holes)
13-1/8"	5/8"	3/32"	\$27.70 SVB13125625093	N/A	3	-
13-1/8"	11/16"	5/32"	\$36.86 SVB131251116152	N/A	3	Delta 22-401 (No slots in knife.)
13-1/8"	1"	1/8"	\$43.46 SVB131251125	\$155.88 SBC131251125	3	Delta RC-33 & DC-33 13" Planer, Rockwell
13-3/8"	15/32"	1/16"	\$40.01 PKH-12828	N/A	3	13" Rigid R4331 & R4330 (Double Edge, with Holes)
13-5/8" 346mm	25/32" 20mm	1/8" 3mm	\$55.77 SVB1278136	N/A	2	Baker 412
15"	1"	1/8"	\$49.71 SVB151125	\$178.15 SBC151125A	3	Delta DC-380, Gri lly G6701, Reliant, Woodtek, TLL, Powermatic 15, Jet 708529G, JWP-15CS, JWP-15HO, Jet Knife 708807, JWP15HI-K, Most 15" Imports
15-1/16"	1"	1/8"	\$49.95 SVB15-1/161125	N/A	3	Delta 22-677
15-1/2"	5/8"	1/8"	\$49.95 SVB155625125	N/A	2	Craftsman 351.217450
15-1/2"	0.7"	1/8"	\$59.40 SCV1207-15.5	N/A	3	RBI Model 616 (Corrugated Back Planer Knives)
15-3/4"	1-3/16" 30mm	1/8" 3mm	\$82.07 SVB15751187125	\$248.03 SBC15751187125	4	SCMI
16"	1"	1/8"	\$52.97 SVB161125	N/A	3	Jet JWP16
16"	1-1/8"	1/8"	\$78.82 SVB161125125	N/A	4	Bridgewood, Crescent, Gri lly 16"
16"	1-1/4"	1/8"	\$65.62 SVB16125125	\$192.21 SBC16125125	3	North eld 16HD
16-1/8"	7/8"	1/8"	\$36.25 SVB16125875125-2	N/A	2	Central Machine Auto Planer T39775
16-5/32" 410mm	25/32" 20mm	1/8" 3mm	\$64.76 SVB127816	N/A	2	Logosol PH260, Baker 412
16-3/16"	1-3/16" 30mm	1/8" 3mm	\$84.38 SVB161871187125	\$255.96 SBC161871187125	4	SCMI
16-1/4"	1-1/4"	5/32"	\$78.62 SVB1625125156	\$197.87 SBC1625125156	3	Powermatic 160
16-1/2"	11/16"	1/8"	\$49.53 SVB1650687125	\$255.19 SBC1650687125	4	RBI Model 816
18"	1-1/4"	5/32"	\$87.07 SVB18125156	\$218.84 SBC18125156	3	Powermatic
18-1/8"	1-1/8"	5/32"	\$78.97 SVB181251125156	\$212.70 SBC181251125156	3	Rockwell, Delta 22-212, ates J180
18-1/4"	1-1/4"	5/32"	\$88.24 SVB1825125156	\$221.91 SBC1825125156	3	Powermatic180
18-1/2"	11/16"	1/8"	\$41.60 SVB1825687125	\$216.03 SBC1825687125	3	Woodmaster 718
20"	1"	1/8"	\$65.74 SVB201125	\$238.29 SBC201125	3	Gri lly, Northwood
20"	1"	1/8"	\$87.60 SVB201125A	\$313.80 SBC201125A	4	Parks, TLL 20", Jet 208, Northstate, Gri lly G6702, Powermatic 209, Sunhill
20"	1-1/8"	1/8"	\$98.60 SVB201125125	\$315.08 SBC201125125	4	Delta 20x9 Crescent, Many European Machines
20"	1-3/16"	1/8"	\$103.79 SVB201187125	\$215.84 SBC201187125	4	Delta 20" Planer, Gri lly 20" H7269, Many Imports
20"	1-1/4"	1/8"	\$82.05 SVB20125125	N/A	3	Woodtek 20"
20-5/64" 510mm	25/32" 20mm	1/8" 3mm	\$82.01 SVB127820	N/A		Logosol PH360
20-3/16"	1-3/16"	1/8"	\$104.21 SVB201871187125	\$317.89 SBC201881187125	4	Delta DC-580
20-3/16"	1-3/8"	1/8"	\$116.37 SVB201871375125	\$319.95 SBC20188138125	4	Delta RC-51, 22-460, Phinero

GLOBAL Planer & Jointer Knife Sets

Length	Width	Thickness	V2-HSS Set Price / Part #	Carbide Tipped Set Price / Part #	Knives in Set	Fits Planer / Jointer
20-1/4"	1-1/4"	5/32"	\$97.98 SVB2025125156	\$247.25 SBC2025125156	3	Powermatic 221
20-1/2"	11/16"	1/8"	\$61.58 SVB2050687125	\$317.89 SBC2050687125	4	RBI Model 820
20-1/2"	0.7"	1/8"	\$82.48 SCV1207-20.5	N/A	3	RBI (Corrugated Back Planer Knives)
20-1/2"	1-3/16" 30mm	1/8" 3mm	\$105.44 SVB20501187125	\$323.52 SBC20501187125	4	SCMI 520, 550, 552
20-1/2"	1-3/8"	1/8"	\$122.89 SVB205138125	N/A	4	
22-1/8"	1"	1/8"	\$96.89 SVB221251125	N/A	4	Powermatic 201
24"	1-1/4"	5/32"	\$154.82 SVB24125156	\$382.90 SBC24125156	4	Powermatic & North eld
24-1/8"	1-3/16"	1/8"	\$124.13 SVB241251187125	\$379.83 SBC241251187125	4	Gri ly G6705
24-1/4"	1-1/8"	1/8"	\$89.83 SVB24251125125	\$289.48 SBC24251125125	3	Delta 22-470
24-1/4"	1-1/8"	1/8"	\$119.76 SVB24251125125-4	\$380.85 SBC24251125125-4	4	Cresent (Delta)
24-1/4"	1-1/4"	5/32"	\$156.75 SVB24125156-4	N/A	4	Powermatic 225
24-3/4"	1-1/8"	1/8"	\$91.62 SVB24751125125	\$295.37 SBC24751125125	3	Jet 24H
24-13/16"	1-3/8"	1/8"	\$140.46 SVB248121375125	\$399.81 SBC24813138125	4	Delta RC-63, 22-610
25"	11/16"	1/8"	\$87.62 SVB25687125	\$292.30 SBC25688125	3	Woodmaster 725
25"	1-1/4"	1/8"	\$141.39 SVB25125125	\$395.31	4	Powermatic
25"	1-3/8"	1/8"	\$144.34 SVB25138125	\$396.00	4	Pinheiro
25-13/16"	1-3/8" 35mm	1/8" 3mm	\$145.86 SVB251871375125	\$399.81 SBC25813138125	4	SCMI F630 & F535

GLOBAL

Portable Planer & Electric Handheld Planer Knife Sets



We now offer knife sets for common handheld electric power planers from Makita, Bosch, Hitachi, Freud, Metabo, Skil, DeWalt, and Black & Decker. These knives may fit in some handheld power planers not listed. Please contact us for any additions or corrections on planer compatibility.

Handheld Electric Planer Knife Sets							
Length	Width	Thickness	Part #	Price	Grade	Knives in Set	Fits Planer
3-1/4" 82mm	13/64"	3/64"	PKH-12831	\$11.62	Carbide	2	Makita 1100, 1900B, N1900B, 1902, 1902X7, 1923B, N1923B, KP0810, KP0800K, OEM # D16966. Black & Decker 7696, 7698, 7698K, BD6500, 7698L, 79-699. Bosch PA1202, 1560, 1593, 1594, 1594K, 3296, 3365, 53518, 53514, PL1682. Craftsman 900173700. DeWalt DW6654, DW677, DW678, DW680, D26677K. Metabo HO0882. Porter Cable 367 Type 1, 9125. Ryobi HPL50K-30, HPL51K. Skil HD1555. (Double Edged) <i>Note: Set Plates for Old Makita or Old DeWalt Planer conversion not included.</i>
3-1/4" 82mm	1-3/32"	1/8"	PKH-12833	\$9.44	HSS	2	Hitachi P20SBK, P20SB, (Single Edge)
3-1/4" 82mm	1-1/8"	1/8"	PKH-12834	\$9.44	HSS	2	Makita 1100, 1900B, N1900B, 1923B, N1923B, OEM # 731001-4, DeWalt DW6655, DW677, DW678, and DW680K. (Single Edge)
3-1/4" 82mm	1-1/8"	1/8"	PKH-12835	\$14.58	Carbide Tipped	2	Makita 1100, 1900B, N1900B, 1923B, N1923B, OEM # 793007-0, DeWalt DW6655, DW677, DW678, and DW680K. (Single Edge)
4-3/8"	1-1/8"	1/8"	PKH-12836	\$13.57	HSS	2	Makita 1002BA, 1911B, 1912B, 1805B, OEM #793008-8. (Single Edge)



We offer knife sets for common portable bench top planer and jointer machines from Craftsman, Delta, DeWalt, Ridgid, Ryobi, and more. PKH Knife dimension measurements shown in inches are approximates.

Portable Planer Knife Sets							
Length	Width	Thickness	Part #	Price	Grade	Knives in Set	Fits Planer
6"	16.5mm	2.7mm	PKH-14803	\$28.48	HSS	3	6" Delta 37-195, Delta 37-275X & Delta 37-190 (Single Edge)
6"	7/8"	1/16"	PKH-14801	\$24.68	HSS	2	6" Delta 37-070 & Delta JT160 (Single Edge)
12"	15/32"	1/16"	PKH-12804	\$37.98	HSS	2	12" Craftsman 21722, Central Machinery 95082 (Double Edged)
12-15/32"	3/4"	1/16"	PKH-12810	\$47.54	HSS	2	12" Delta 22-540 (Double Edged)
12-1/2"	15/32"	1/16"	PKH-12803	\$48.49	HSS	2	12-1/2" Delta 22-560, 22-565, TP305, TP400LS, Ryobi AP-12, Craftsman 21758, Grizzly G0663, Performax 240-3749, Porter Cable PC305TP, Powertec PL1250 (Double Edged)
12-1/2"	45/64"	1/8"	PKH-12818	\$47.63	HSS	2	12-1/2" Craftsman 233780, Wilton 99178 & 34463, Rockwell RK9018, Jet 708813, JWP-12DX (Double Edge)
12-1/2"	7/8"	1/16"	PKH-12801	\$56.09	HSS	3	12-1/2" DeWalt DW734 (Double Edged)
12-1/2"	1-1/16"	1/8"	PKH-12809	\$52.29	HSS	2	12-1/2" DeWalt DW733 (Single Edge)
13"	15/32"	1/16"	PKH-12802	\$48.49	HSS	2	13" Delta 22-580 & Delta TP300, Grizzly G0689 (Double Edged)
13"	1/2"	1/16"	PKH-12806	\$34.18	HSS	2	13" Ryobi AP1300, Order 2 Sets for 3 Knife Craftsman Model 21748 & 3 Knife Masterforce Model 2400045 (Double Edged)
13"	3/4"	1/16"	PKH-12807	\$46.59	HSS	2	13" Ridgid TP1300 (Double Edged)
13"	3/4"	1/16"	PKH-12826	\$46.59	HSS	2	13" Ryobi AP1301 (Double Edged)
13"	7/8"	1/16"	PKH-12800	\$57.99	HSS	3	13" DeWalt DW735 (Double Edged)
13"	7/8"	1/16"	PKH-12800-C	\$129.95	Carbide Tip	3	13" DeWalt DW735 (Single Edge)
13-3/16"	15/32"	1/16"	PKH-12827	\$58.74	HSS	3	13" Delta 22-590 (Double Edge)
13-3/8"	15/32"	1/16"	PKH-12828	\$44.25	HSS	3	13" Rigid R4331 & R4330 (Double Edge)

GLOBAL

We offer several dozen sizes of carbide insert knives for disposable knife insert cutterheads. Contact us for additional sizes not listed. Several grades of carbide also offered - C3 standard. Polished to a mirror finish for smoother cutting and longer tool life.

10% Discount On 500+ Pc Orders!

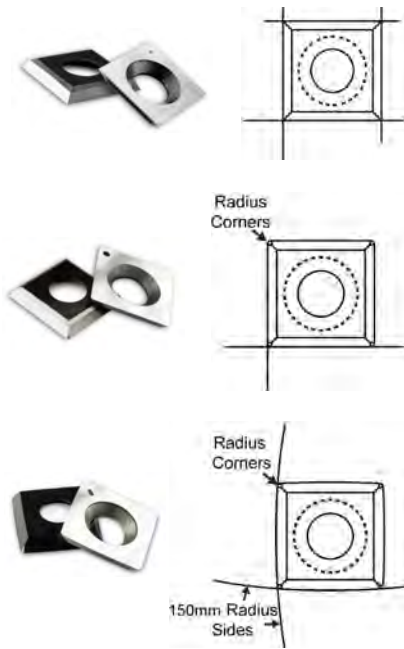

Square Carbide Insert Knives (ICK)						
Insert Size			Part #	Price Each		Cutting Edges
Length	Width	Thick		(10 per box)	Bevel	
12mm	12mm	1.5mm	IC-1512124	\$1.56	35°	4 Edges (Square Corners)
13mm	13mm	2.5mm	IC-2513134	\$2.81	35°	
14mm	14mm	2.0mm	IC-2014144	\$1.73	30°	
14mm	14mm	2.0mm	IC-2014144-RC	\$1.73	30°	4 Edges (Rounded Corners)
14.1mm	14.1mm	2.0mm	IC-20141141-JT	\$2.81	30°	4 Edges (Square Corners) *Fits Gri - ly - Marked JT
14.3mm	14.3mm	2.0mm	IC-2014142-SM	\$2.20	40°	2 Edges *Fits Steel City / ShinMax Heads
14.3mm	14.3mm	2.5mm	IC-25143143	\$2.81	35°	4 Edges (Square Corners)
14.6mm	14.6mm	2.5mm	IC-25146146	\$2.61	30°	
14.6mm	14.6mm	2.5mm	IC-25146146-RC	\$2.61	30°	4 Edges (Rounded Corners)
14.6mm	14.6mm	2.5mm	IC-25146146-8R	\$3.14	30°	4 Edges (8 Radius 4R Faces & 4R Corners)
15mm	15mm	2.5mm	IC-2515154-4	\$2.61	30°	4 Edges (Square Corners)
15mm	15mm	2.5mm	IC-2515154-4RC	\$2.61	30°	4 Edges (Rounded Corners)
15mm	15mm	2.5mm	IC-2515154-8R	\$2.61	30°	4 Edges (8 Radius 4R Faces & 4R Corners)
15mm	15mm	2.5mm	IC-2515154-4100	\$2.61	30°	100mm (4") Radius Faces *Fits Byrd
17mm	17mm	2.0mm	IC-2017174 (4mm Hole)	\$4.89	35°	4 Edges (Square Corners)
19mm	19mm	2.0mm	IC-2019194	\$4.67	35°	

Rectangular Carbide Insert Knives (ICK)								
Insert Size			Part #	Price Each		Holes	Bevel	Cutting Edges
Length	Width	Thick		(10 per box)				
7.5mm	12mm	1.5mm	IC-15127.5	\$1.26	1	35°	2 Edges	
9.6mm	12mm	1.5mm	IC-15129.6	\$1.39				
15mm	12mm	1.5mm	IC-151215	\$1.94				
18mm	12mm	1.5mm	IC-151218	\$2.37				
19.5mm	12mm	1.5mm	IC-1512204	\$2.50	1	35°	4 Edges	
20mm	12mm	1.5mm	IC-151220	\$1.94				
25mm	12mm	1.5mm	IC-151225-1	\$2.76	1	35°	2 Edges	
25mm	12mm	1.5mm	IC-151225-2	\$2.76				
29.5mm	12mm	1.5mm	IC-1512304	\$3.06	2	35°	4 Edges	
30mm	12mm	1.5mm	IC-151230	\$2.37				
30mm	12mm	2.5mm	IC-251230	\$3.56	2	35°	2 Edges	
30mm	12mm	2.5mm	IC-251230-BC	\$3.75				
40mm	12mm	1.5mm	IC-151240	\$3.22	2	35°	2 Edges	
49.5mm	12mm	1.5mm	IC-1512504	\$4.59				
50mm	12mm	1.5mm	IC-151250	\$3.59	2	35°	2 Edges	
60mm	12mm	1.5mm	IC-151260	\$3.98				
80mm	13mm	2.2mm	IC-221380	\$15.56				
100mm	13mm	2.2mm	IC-2213100	\$20.97				
120mm	13mm	2.2mm	IC-2213120	\$22.22				

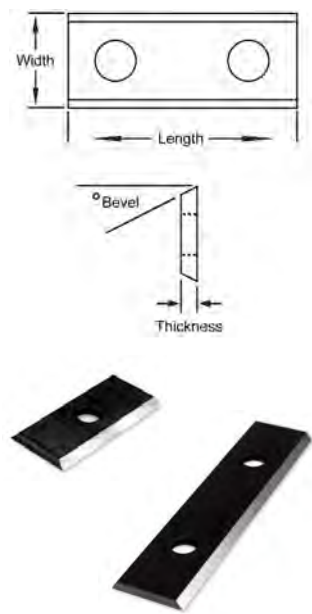

GLOBAL Spiral Insert Knife Surfacing Heads - No Sharpening Required

Quiet Cutting: Looking for a better surfacing head option? Spiral knife insert heads make constant contact with the material, offering reduced cutting noise - typically 20 decibels less. Each long-wearing carbide knife has four edges that can be dulled before replacement. These heads improve material finishes on cross grain, lower long-term tooling cost, and eliminate sharpening costs. Our spiral heads offer special radius edge inserts to reduce any chance of knife corners marking your material. Made from 7071-T6 high-strength aircraft aluminum. Heads include a set of carbide knives ready to run and a Torx wrench for turning and replacing the knives. Heads use 15 x 15 x 2.5 inserts.

Head prices include set of knives. Most heads in stock for immediate delivery.

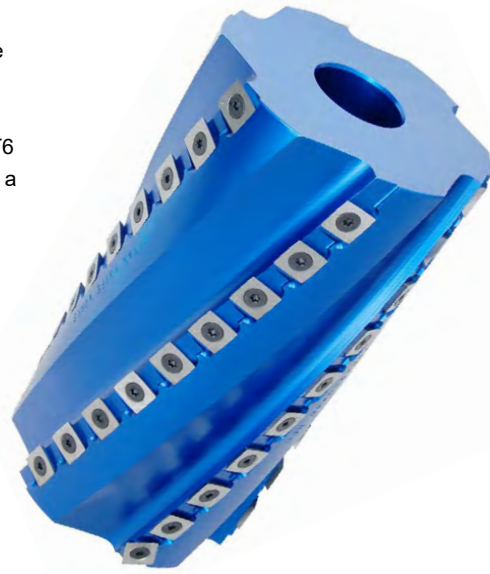

Spiral Insert Knife Surfacing Heads - 6 Row

Cutting Length	Rows of Knives	Body Diameter	Standard Bore	Part #	Price
2" (50mm)	6	100mm	1.25"	MS10042 *	\$290.00
4" (100mm)	6	100mm	1.25"	MS10044 *	\$368.00
6" (150mm)	6	100mm	1.25"	MS10046 *	\$449.00
2" (50mm)	6	125mm	40mm	MS12562	\$335.00
4" (100mm)	6	125mm	40mm	MS12564	\$463.00
6" (150mm)	6	125mm	40mm	MS12566	\$579.00
7" (180mm)	6	125mm	40mm	MS12567	\$675.00
8" (200mm)	6	125mm <td 40mm	MS12568	\$755.55	
9" (230mm)	6	125mm	40mm	MS12569	\$850.00
2" (50mm)	6	125mm	1.5"	MS12562-1.5	\$335.00
4" (100mm)	6	125mm	1.5"	MS12564-1.5	\$463.00
6" (150mm)	6	125mm	1.5"	MS12566-1.5	\$579.00
7" (180mm)	6	125mm	1.5"	MS12567-1.5	\$675.00
9" (230mm)	6	125mm	1.5"	MS12569-1.5	\$850.00
9.5" (240mm)	6	125mm	1.5"	MS12569.5-1.5	\$860.00
2" (50mm)	6	140mm	1-13/16"	MS14062	\$350.00
4" (100mm)	6	140mm	1-13/16"	MS14064	\$496.00
6" (150mm)	6	140mm	1-13/16"	MS14066	\$600.00
7" (180mm)	6	140mm	1-13/16"	MS14067	\$725.00
9" (230mm)	6	140mm	1-13/16"	MS14069	\$875.00
9.5" (240mm)	6	140mm	1-13/16"	MS14069.5	\$898.75
12.2" (310mm)	6	140mm	1-13/16"	MS1406310	\$1196.00

Spiral heads now come with face shear for smoother cutting.

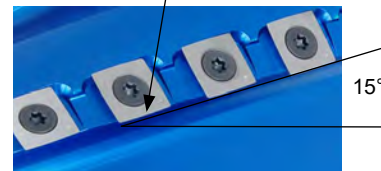

See page 22 for insert knife listings.

Product Description	Part #	Price
Spare Knives -15 x 15 x 2.5mm - 8 Radius	IC-2515154-8R	\$2.61 each
T20 Torx Wrench - 8"	MS-T20W	\$6.50 each
Spare Screws for Titan Spiral Heads		
M6-15 (Torque 4ft/lbs 50inch/lbs)	MS-KS615	\$0.88 each
Spare Screws for Byrd Journal Heads	MS-BS-S	\$0.50 each
Spare Screws for Weinig Spiral Heads	MS-NA-S	\$3.00 each
Spare Screws for Shinmax Spiral Heads	MS-KSSM	\$1.00 each

Custom heads also available including hydro bore and self-centering spiral heads.

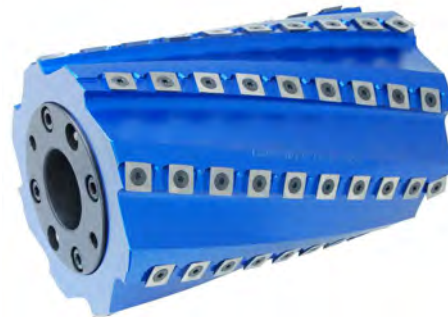

* Non-Shear Type

See page 36 for Reference Engravers.



GLOBAL Machinery

MOLDING STEEL ALL BARS 25" LONG

High Speed Steel Corrugated Knives 35° Bevel

PART	WIDTH	THICKNESS	CORRUGATIONS	PRICE
SCV2-25125	1-1/4	1/4	16-60	\$86.96
SCV2-25150	1-1/2	1/4	16-60	\$94.92
SCV2-25175	1-3/4	1/4	16-60	\$101.45
SCV2-25200	2	1/4	16-60	\$105.98
SCV2-25225	2-1/4	1/4	16-60	\$111.87
SCV2-25250	2-1/2	1/4	16-60	\$118.32
SCV2-31125	1-1/4	5/16	16-60	\$94.84
SCV2-31150	1-1/2	5/16	16-60	\$104.22
SCV2-31175	1-3/4	5/16	16-60	\$112.31
SCV2-31200	2	5/16	16-60	\$116.79
SCV2-31225	2-1/4	5/16	16-60	\$125.17
SCV2-31250	2-1/2	5/16	16-60	\$134.91
SCV2-31275	2-3/4	5/16	16-60	\$140.54
SCV2-31300	3	5/16	16-60	\$159.38

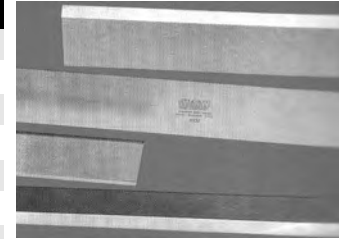

Lumber and wood working plants the world over specify M-2 High-Speed Steel knives to produce the finest finish cuts in planer, jointer, molder, and tenon operations. The consistent hardness and high molybdenum content give an excellent edge and allows for easy grinding. High-Speed Steel is ideal for medium to long runs.

Williams and Hussey Steel Plain and Corrugated

PART	WIDTH	THICKNESS	CORRUGATIONS	PRICE
SWHV-25175	1-3/4	1/4	Plain Back	\$102.74
SWHV-25200	2	1/4	Plain Back	\$105.38
SWHV-25225	2-1/4	1/4	Plain Back	\$113.13
SWHV-25250	2-1/2	1/4	Plain Back	\$119.93
SWHV-25200C	1-3/4	3/16	16-60	\$112.58
SWHV-25225C	2-1/4	1/4	16-60	\$120.34
SWHV-25250C	2-1/2	1/4	16-60	\$127.13

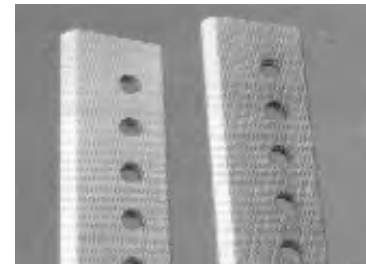

ALL BARS 25" LONG

High Speed Bevel Edge Shaper Steel - 30° Bevel

Part	Length	Width	Thickness	Price
41260	25"	1-1/2"	5/16"	\$ 153.02
41262	25"	1-3/4"	5/16"	\$ 197.15
41264	25"	2"	5/16"	\$ 197.15
41266	25"	2-1/4"	5/16"	\$ 236.26
41270	25"	2-3/4"	5/16"	\$ 249.00
41272	25"	3"	5/16"	\$ 249.00
41274	25"	3-1/4"	5/16"	\$ 249.00
41276	25"	3-1/2"	5/16"	\$ 249.00

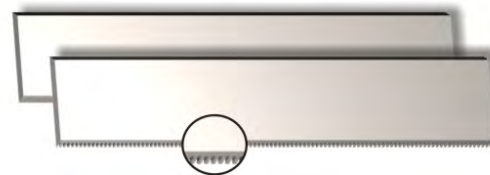

**CLOSEOUT PRICING ON
ABOVE BEVEL EDGE SHAPER
STEEL WHILE SUPPLIES LAST.**

**OTHER SIZES OF WKW STEEL
ARE ALSO AVAILABLE.**

AMV International High Speed Steel Circular Saw Blades

★ Sharpening Services Are Provided For
 All Sizes and Types Saw Blades.
 ★ Check Our Sharpening Section At
 Page XXX-XXX.

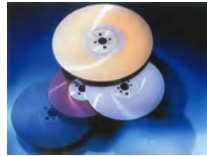
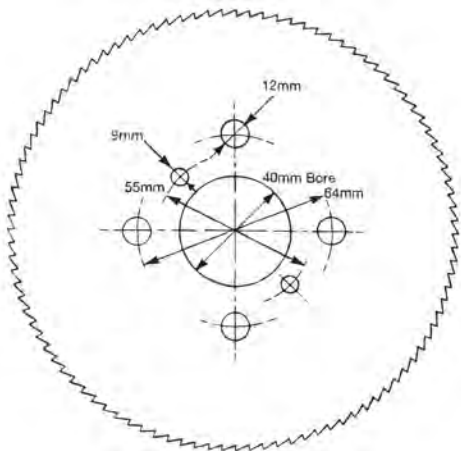

For ferrous metals it is common industry practice to provide multiple patterns on a blade to accommodate more than one machine.

- Most Popular Pinhole Patterns:
 32 mm Bore Pinhole Patterns are 2/8.5/45 & 2/12/64
 For: Brown, IBP, Amnada, Kalama oo, Pedra olli, Startrite, Scotchman, Brobo, Dake, Wilton
 32 mm Bore Pinhole Patterns are 1/8.5/50 & 1/9/60
 For: hydromat and Urbama
 32 mm Bore Pinhole Patterns are 4/9/50 and 2/12.5/75
 For: Wagner and Thomas
 38 mm Bore Pinhole Pattern is 2/9/55
 For: Brobo
 40 mm Bore Pinhole Patterns are 2/9/55 and 4/12/64
 For: Brobo, Eisele, Haberle, Doring, Scotchman, Trennjaeger
 50 mm Bore Pinhole Patterns are 4/15/80 and 4/14/85
 For: Katenbach, Kasto and Trennjaeger

Diameter	Thickness	Bore	Teeth	Price
250	2	32	220	\$ 78.43
250	2	32	200	\$ 78.43
250	2	32	180	\$ 78.43
250	2	32	120	\$ 78.43
275	2.5	40	220	\$ 96.32
300	2.5	38	380	\$ 121.94
300	2.5	32	220	\$ 121.94
300	2.5	32	180	\$ 121.94
300	2.5	32	150	\$ 121.94
315	2.5	40	150	\$ 128.57
315	2.5	40	180	\$ 128.57
315	2.5	40	150	\$ 128.57
315	2.5	40	140	\$ 128.57
315	2.5	32	180	\$ 128.57
350	3	40	280	\$ 170.68
350	3	40	220	\$ 170.68
350	3	40	180	\$ 170.68
350	3	40	150	\$ 170.68
350	3	40	120	\$ 170.68
350	3	32	280	\$ 170.68
350	3	32	220	\$ 170.68
350	3	32	180	\$ 170.68
350	3	32	160	\$ 170.68
350	3	32	140	\$ 170.68
350	3	40	120	\$ 170.68
350	2.5	40	180	\$ 159.54
350	2.5	40	150	\$ 159.54
350	2.5	32	320	\$ 159.54
350	2.5	32	120	\$ 159.54
400	3.5	50	220	\$ 263.46
400	3.5	40	90	\$ 263.46
400	3.5	40	180	\$ 263.46
450	3	50	250	\$ 357.07

We stock above blades, other sizes allow 1-2 weeks
 For Re-grinding Prices, See Sharpening Section.

Stark High Speed Steel Circular Saw Blades

For Cutting Non-Ferrous Metals

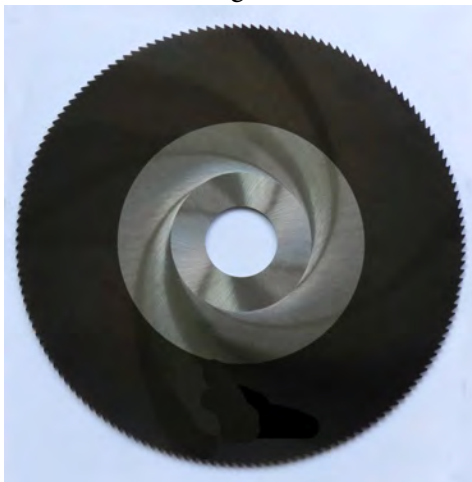

Machines for non-ferrous metals are usually 5/8" or 1" bore without pin holes except for Wagner machines which are 32 mm bore with 4/9/50.

We stock the following size blank saw plates. The number of teeth do not affect the price. We need 2-3 days to manufacture.

Diameter	Thickness	Bore	Price
10	1/16	5/8" or 1"	\$105.00
10	3/32	5/8" or 1"	\$105.00
12	1/16	1"	\$125.00
12	3/32	1"	\$125.00
13	3/32	1"	\$135.00
14	3/32	1"	\$145.00

HITACHI BAND SAW BLADES

HITACHI BAND SAW BLADE FOR CB75F
 This blade has Stellite on *EVERY* tooth.

Part #	Width	Gauge	Length	TPI	Hook	Kerf	Finish	Stellite	Price
939971	3"	.026	110.71"	1	22°	0.051	Very Smooth	Every Tooth	\$189.00

HITACHI BAND SAW BLADE FOR CB75F
 This blade has Stellite on *EVERY OTHER* tooth.

Part #	Width	Gauge	Length	TPI	Hook	Kerf	Finish	Stellite	Price
967701	3"	.026	110.71"	1	22°	0.051	Very Smooth	Every Other Tooth	139.00

NEED A CUSTOM SIZE BAND SAW BLADE?
 PLEASE GIVE US THIS INFORMATION AND WE CAN GET YOU A PRICE!!

- 1) Length_____
- 2) Width_____
- 3) # Teeth Per Inch_____
- 4) Style of Teeth_____
- 5) Thickness of Band Saw_____

ON ALL CUSTOM BLADES THERE IS A MINIMUM OF 3 BLADES PER SIZE. AND PLEASE ALLOW 1-3 WEEKS FOR DELIVERY!!

HITACHI CIRCULAR SAW BLADES (Carbide Tipped)

Part #	Diameter	# Teeth	Grind	Arbor	Kerf	Plate	Hook	Price
725206	10"	72	ATB	5/8"	0.098 in.	0.071 in.	15 Degrees	\$49.35

Hitachi



6-1/2-inch blade ensures complete cutting of 2-by material at 45-degree bevel
 Max cutting depth at 90 degrees is 2-1/4 inches, at 45 degrees is 1-9/16 inches
 Adjustable kerf indicator
 Durable nickel-plated cast-aluminum base
 No-load speed of 3,400 rpm

Includes:

Case

C6DC

18 Volt Cordless Circular Saw

\$159.00



\$119.00

DS14DMR

14.4V Cordless 1/2\"/>

High performance, fan-cooled, rare-earth magnet motor for optimal performance
 Class leading 450in/lbs of torque to power through the toughest jobs
 2-piece rare-earth magnet motor for greater durability and increased performance
 1/2" keyless chuck, offers tool-free convenience
 Heavy-duty aluminum clutch ring adds durability
 22-stage slip-clutch for precision screw driving
 Convenient 5-position belt hook features an integrated amber LED work light
 High capacity 2.0 Ah batteries allow for longer run time and fewer battery charges
 Externally accessible carbon brush for quick and easy brush changes
 Non-slip Elastomer grip handle, maximizes user comfort and control
 5.1lbs, lightweight and compact for maximum maneuverability
 Ergonomic nose-high design, adds balance and ease of use

Includes:

Two 2.0Ah NiCD Batteries (315129)
 Universal Charger (UC14 FA)
 Detachable Side Handle (323001)
 Driver Bit (983006)
 Injection molded carrying case (323230)



\$179.00

DS18DMR

**18-Volt Ni-MH 1/2-Inch
 Cordless Drill/Driver Kit**

High performance, fan-cooled, rare-earth magnet motor for optimal performance
 Class leading 550in/lbs of torque to power through the toughest jobs
 2-piece rare-earth magnet motor for greater durability and increased performance
 1/2" keyless chuck, offers tool-free convenience
 Heavy-duty aluminum clutch ring adds durability
 22-stage slip-clutch for precision screw driving
 Convenient 5-position belt hook features an integrated amber LED work light
 High capacity 3.0 Ah batteries allow for longer run time and fewer battery charges
 Externally accessible carbon brush for quick and easy brush changes
 Non-slip Elastomer grip handle, maximizes user comfort and control
 5.73lbs, lightweight and compact for maximum maneuverability
 Ergonomic nose-high design, adds balance and ease of use
 Rated #1 18V Cordless Drill on the market by a Leading Consumer Publication

Includes:

Two 3.0Ah NiMH Batteries (322877)
 Rapid Charger (UC24 J)
 Detachable Side Handle (323001)
 Driver Bit (983006)
 Injection molded carrying case (323230)

Hitachi



\$199.00

DV14DL
14.4-Volt Lithium Ion
Cordless Hammer Drill

Class leading 460in/lbs of torque to power through the toughest jobs
 High performance, fan-cooled, rare-earth magnet motor for optimal performance and overload protection during continuous operation
 Unique 2-step Save Mode switch lets the user select from 4 speed settings (0-200/400/850/1750 RPM) for ultimate control
 1/2" industrial grade keyless all metal chuck, with ratcheting lock mechanism prevents bit slippage offers tool-free convenience
 Externally accessible carbon brushes for easy replacement and prolonged tool life
 22-stage slip-clutch for precision screw driving with 2-modes of operation including drilling, and hammer drilling
 Equipped with Hitachi's patented 5-position belt hook with an integrated LED work light to conveniently illuminate dark work spaces
 A non-slip elastomer grip provides more control, comfort and absorbs vibration
 HXP Li-ion Technology

Includes:
 2 x 3.0Ah Li-ion 14.4V Batteries
 Cross-Compatible Charger (UC18 RL)
 Case (323230)

\$359.00

KC18DL
18V Pro-Grade Combo Kit



Includes:
 6-1/2" Circular Saw, C6DC2
 1/2" Driver Drill, DS18DMR
 Reciprocating Saw, the CR18DV
 18V Flashlight
 Super Charger
 2 High Capacity 3.0Ah Ni-MH Batteries
 Carrying Bag

Kit includes DS18DMR 18V 1/2" driver drill that offers an incredible 550in/lbs of torque
 Kit includes CR18DV 18V reciprocating saw with anti-vibration Elastomer grip
 Kit includes C6DC2 18V 6-1/2" circular saw
 Kit includes a powerful 18V flashlight with pivoting head and shoulder lanyard
 Kit includes two high capacity 3.0Ah NiMH batteries
 Kit includes new, revolutionary Super Charger that charges 9.6 to 18-Volt batteries and features an AC/DC converter that powers cordless tools
 Kit includes ballistic nylon carrying bag that allows for easy transport and storage



\$89.00

N3804AB3
1/4" Narrow Crown Stapler, 18 Gauge,
1/2-Inch to 1-1/2-Inch Staple Length

2.2 lbs, lightweight and compact for easy use in tight spaces
 New selective actuation switch lets the user easily select bump fire or sequential fire modes
 360 degree adjustable exhaust, can be directed away from user in any direction
 High-capacity magazine, holds up to 125 staples for maximum efficiency
 Tool-less, easy-to-clear nose, for quick and simple staple extraction
 Tool-less depth of drive, adjusts for flush or countersunk drives into varying material providing control and customization
 Small No-mar tip included to prevent work surface damage
 Elastomer grip adds comfort and security

Includes:
 Safety Glasses (875769)
 Case (885902)
 No-Mar Tipx2 (885969)

Hitachi



\$79.00

NT50AE2
18-Gauge 5/8-Inch to 2-Inch
Brad Nailer

NT50AE2 accepts 5/8" to 2" 18-gauge fasteners
 New selective actuation switch lets the user easily select bump fire or sequential fire modes
 At only 2.2 lbs, it is well balanced and lightweight to make finish work a breeze
 Elastomer grip adds comfort while preventing slippage
 Visual nail reload indicator located on the magazine, alerts the user when nail quantities are low so that blank drives are avoided
 Tool-less, easy-to-clear nose for quick and simple nail extraction should a nail jam during use
 Engineered with the safety behind the narrow nosepiece and short center height to allow for nail placement in hard to reach areas and corners
 Depth of drive dial allows the user to easily adjust the drive depth for a professional finish
 No-mar tip on the nose protects the work piece from markings
 360 degree adjustable exhaust port keeps dust, debris and oil off the finish project
 Lightweight aluminum body and composite magazine provide for a tool that reduces user fatigue

Includes

Safety Glasses (875769)
 Air Fitting
 Hex Bar Wrenches
 Carry Case (885902)
 No-Mar Tip



\$199.00

WH14DL
14.4-Volt Lithium Ion
Cordless Impact Driver

Class leading torque - 1,240 in-lbs to power through the toughest jobs with ease
 Industrial grade, two-piece motor with heavy gauge copper coils that make it the most powerful and long lasting
 Hitachi's unique Cool Flow system provides a steady stream of air to the motor, allowing the impact to run harder and longer, minimizing the risk of burnout
 Unique two-step speed switch lets the user select between Power Mode (0-2,600 RPM) or Save Mode (0-2,000 RPM) for ultimate control based on the application
 Externally accessible carbon brush and replaceable armature greatly prolongs tool life
 5-position belt hook, convenient for in between use, features an integrated LED work light to illuminate dark work spaces
 Compact and lightweight at only 6-3/8" in length and 3.3 lbs for maneuverability
 High power HXP Li-ion battery technology features extended run time, fade free power, 40% less weight and 3 times the power capacity of standard Ni-Cd/Ni-Mh batteries
 HXP Li-ion Technology

Includes:

2 x 3.0 Ah Batteries (326823)
 Universal Charger (UC18 RL)
 Carrying Case (324512)



\$99.00

WR12DMR
12V Cordless Impact Wrench

Class leading torque- 1,420 in-lbs to power through the toughest jobs
 High performance, fan cooled, 2-piece motor for greater durability and increased performance
 Externally accessible carbon brush and replaceable armature greatly prolongs the life of the tool
 Electronic feedback power control for equal torque and rpm in both forward and reverse
 5-position belt hook, convenient for in between use, features an integrated LED work light that illuminates dark work spaces
 High capacity 2.0Ah batteries allows for longer run time and fewer battery changes
 3.5 lbs, lightweight and compact for ease of use and easy maneuverability

Includes:

Two 2.0Ah EB1220BL Batteries (320386)
 Charger (UC14 FA)
 Carrying Case (322070)

Imperial Blades

Item #	Packs	Price	Description
IBOA120-1	1	\$ 8.95	ONE FIT 3/8" DETAIL WOOD HCS Detailed plunge cuts up to 1-5/8" depth in non-metal materials.
IBOA133-1	1	\$ 12.95	ONE FIT 1-1/4" DEEP WOOD HCS General purpose plunge cuts up to 2-5/8" depth in non-metal materials.
IBOA133-10	10	\$ 99.95	
IBOA200-1	1	\$ 9.95	ONE FIT 1-1/4" FAST WOOD HCS General pupose plunge cuts up to 1-5/8" depth in non-metal material.
IBOA200-10	10	\$ 79.95	
IBOA220-1	1	\$ 11.95	ONE FIT 1-1/4" JAPANESE PRECISION HCS Japanese teeth for precision cutting in hardwoods up to 1-5/8" depth.
IBOA220-10	10	\$ 89.95	
IBOA250-1	1	\$ 10.95	ONE FIT 2-1/2" FAST WOOD HCS General purpose plunge cuts up to 1-5/8" depth in non-metal materials.
IBOA250-10	10	\$ 89.95	
IBOA270-1	1	\$ 12.95	ONE FIT 2-1/2" JAPANESE PRECISION HCS Japanese teeth for precision cutting in hardwoods up to 1-5/8" depth.
IBOA270-10	10	\$ 99.95	
IBOA300-1	1	\$ 9.95	ONE FIT 1-1/4" WOOD W/NAI LS BM Bi Metal for longer life cutting in wood w/nail applications. 1-5/8" plunge depth.
IBOA300-10	10	\$ 79.95	
IOBA391-1	1	\$ 19.95	ONE FIT 2" 90 DEGREE PUNGE CUT BLADE Ideal for hard to reach applications such as cabinet toe kicks to remove flooring. 1" cutting depth.



Imperial Blades

Item #	Packs	Price	Description
IBOAT340-1	1	\$ 15.95	ONE FIT 1-1/4" UNIVERSAL BM TiN Titanium Enhanced Bi-Metal for longer life cutting in metal and wood applicatoins. 2-1/8" plunge depth.
IBOAT340-10	10	\$ 109.95	
IBOAT330-1	1	\$ 14.95	ONE FIT 1-3/4" UNIVERSAL BM TiN Titanium Enhanced Bi-Metal for longer life cutting in metal and wood applications. 2-1/8" plunge depth.
IBOAT330-10	10	\$ 99.95	
IBOAT336-1	1	\$ 13.95	ONE FIT 1-1/4" WOOD W/NAILS BM TiN Titanium Enhanced Bi-Metal for longer life cutting in wood w/nail applications. 1-5/8" plunge depth.
IBOAT336-10	10	\$ 84.95	
IBOAT337-1	1	\$ 14.95	ONE FIT 2-1/2" UNIVERSAL BM TiN Titanium Enhanced Bi-Metal for longer life cutting in wood w/nail application. 1-5/8" plunge depth.
IBOAT337-10	10	\$ 99.95	
IBOAT410-1	1	\$ 24.95	ONE FIT 3-1/8" SEGMENT HSS SAW TiN STORM BLADE Ideal for cutting wood, fiberglass and sheet metal.
IBOAT410-5	5	\$ 89.95	
IBOA730-1	1	\$ 44.95	ONE FIT SEGMENT BOOT DIAMOND High service life for removal of plaster, grout, porous concrete and concrete. Kerf, approx. 3/32".
IBOA500-1	1	\$ 9.95	ONE FIT RIGID SCRAPER BLADE For removal of stubborn paint, adhesive residue, tile adhesive, window putty. Great for cutting carpet and old laminate



Imperial Blades

Item #	Packs	Price	Description
MM100	1	\$ 12.95	1-1/4-Inch Fine Tooth Universal Oscillating Wood Blades 1-5/8 inch depth. 16 tpi. for precision wood applications
10MM100-10	10	\$ 89.95	
MM110	1	\$ 12.95	3/4-Inch Fine Tooth Universal Oscillating Wood Blades 1-5/8 inch depth, 16 tpi, for precision wood applications
10MM110-10	10	\$ 89.95	
MM120	1	\$ 12.95	3/8-Inch Fine Tooth Universal Oscillating Wood Blades 1-5/8 inch depth, 16 tpi, for precision wood applications
10MM120-10	10	\$ 89.95	
MM133	1	\$ 14.95	1-1/4-Inch Fine Tooth Universal Oscillating Plunge Blades 2-5/8 inch plunge, for precision wood applications
10MM133-10	10	\$ 99.95	
MM150	1	\$ 14.95	2-1/2 -Inch Fine Tooth Universal Oscillating Wood Blades 1-5/8 inch depth, 16 tpi, for precision wood applications
10MM150-10	10	\$ 99.95	



MM100



MM110



MM120



MM133



MM150

Imperial Blades

Item #	Packs	Price	Description
MM390	1	\$ 21.95	90 Degree Bi-Metal Universal Oscillating Reach Blade
MM500	1	\$ 9.95	2-Inch Rigid Universal Oscillating Scraper Blade
MMRSPK	1	\$ 14.95	4-Inch Round Oscillating Sanding Pad 60, 80, 120 & 180 Grits included, 4 of Each
MM510	1	\$ 8.95	2-3/4-Inch Flexible Universal Oscillator Scraper Blades 1-1/2 inch plunge depth
3MM510-3	3	\$ 24.95	
MM640	1	\$ 16.95	1-1/4-Inch Flush Cut Carbide Universal Oscillating Blades Made of crushed carbide, Arbor design is universal
3MM640-3	3	\$ 44.95	
MM410	1	\$ 34.95	3-1/8 inch High Speed Steel Segment Saw Blade 1-1/16 inch depth, 18 tpi, Arbor design is universal
5MM410-5	5	\$ 127.95	
MMT410	1	\$ 32.95	Titanium Enhanced 3-1/8 inch High Speed Steel Segment Saw Blade 1-1/16 inch depth, 18 tpi
5MMT410-5	5	\$ 132.95	



MM390



MM500



MM510



MM640

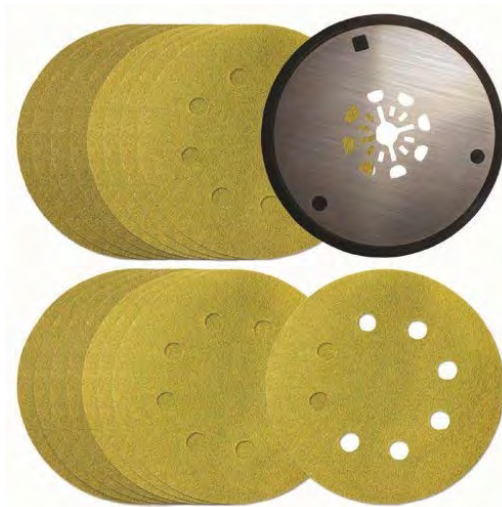

MMRSPK



MM410



MMT410

Kreg Tools Cutting and Measuring

Rip-Cut™

ITEM# KMA2675 \$34.99

SPECIFICATIONS

Materials	Aluminum Guide Rail Size:	Saw Sled Size:	Cut Width:
High-quality aluminum, impact-resistant plastic polymer	3" wide x 30" long (7.6mm x 76mm)	6½" x 8½" (165mm x 216mm)	Up to 24" (610mm)



The Rip-Cut™ features a simple yet durable design, that includes a solid-aluminum guide rail, an easy-to-read adjustable scale, and a reversible guide arm.

A The Rip-Cut™ quickly and easily connects to almost any circular saw—left or right blade. It's easy to use, whether you're left- or right-handed.

B No table saw? No problem. The Rip-Cut™ has a 24" capacity, meaning you can rip a 4'x8' sheet of plywood in half.



C The Rip-Cut™ guide arm supports your blade through 100% of the cut – reducing blade wander at the end of the cut.

D After you rip your sheet, you can use the Rip-Cut™ to break your material down into smaller pieces, too.

Shelf Pin Jig

ITEM# KMA3200 / KMA3220

KMA3200 - 1/4" (6mm) Bit \$34.99

KMA3220 - 5 mm Bit \$34.99

SPECIFICATIONS

Fence	Standard Hole Spacing
Dual-Position, Adjustable (1" & 2") (25mm or 50mm)	32 mm

DRILL GUIDES

Hardened steel drill guides ensure precise drilling. Accepts both ¼" (6mm) and 5mm bits.



LOCATING PIN

Locating pin lets you quickly reference last hole drilled.



JIG EXTENDER

Jig Extender connects two or more jigs together.



\$7.99

ITEM#
KMA3210
(¼") (6mm)

\$7.99

ITEM#
KMA3215
(5mm)

Drill Bits

Choose between ¼" (6mm) and 5mm bits. 5mm bit features stepped design that allows it to fit precisely inside the Shelf Pin Jig's drill guides. Both bits include depth collar and allen wrench.

Includes:

Shelf Pin Jig, locating pin, jig extender, drill bit, depth collar, hex wrench, instruction manual, and (4) shelf pins.

Kreg Tools Cutting and Measuring Crown-Pro™

ITEM# KMA2800 \$29.99

Includes:

(1) Crown-Pro™, double-sided Angle Finder, rubber feet, and Owner's Manual. You can also find a helpful crown-installation video online.



SPECIFICATIONS		
Size	Max Workpiece Width	Spring Angle Range
3.14" x 14.94" x 4.17" (80mm x 380mm x 106mm)(H x W x D)	5-1/2" w/ 12" Saw, 3-1/2" w/ 10" Saw 140mm w/ 305mm Saw, 89mm w/ 254 Saw	30°- 65°

Simple Steps to Perfect Crown:



Find Your Angles:

Use the Angle Finder to determine the correct spring angle of your crown molding, and the wall angle.

Set Your Angles:

Set your Crown-Pro™ to match your spring angle, and set your saw to match the wall angle.

Make Your Cuts:

Position your Crown-Pro™ on either side of your saw based on the type of joint, and then make cut.

Install Your Crown:

Position your crown on the wall and nail it securely into place. You'll get perfect results with the Crown-Pro™.

Square-Cut™ ITEM# KMA2600 \$11.99

ADJUSTABLE GUIDE ARM

The guide arm is adjustable, so you can set it to match the offset between the edge of the saw base and blade. Simply position the end of the guide arm on your cut line, and the Square-Cut™ will be automatically aligned to guide your saw through the cut.



MADE TO FIT MOST SAWS

The guide arm on the Square-Cut™ can be adjusted to fit most circular saws or jig saws. Adjustments take only a few seconds with the use of a Phillips-head screwdriver.



ANY MATERIAL UP TO 12" (305mm) WIDE

The Square-Cut™'s extended body allows it to work effectively with stock up to 12" (305mm) wide, making it perfect for use with siding, deck boards, and more. In addition, a built-in roof pitch layout tool makes quick work of cutting siding, fascia, and rafters on the job site.



Multi-Mark™ ITEM# KMA2900 \$14.99

HUNDREDS OF USES

The Multi-Mark™ doesn't know the meaning of the term 'single-purpose.' Thanks to three unique scale configurations, a built-in level, and more, the applications are nearly endless.



Lay Out Mitered Corners



Set 3/16" (5mm) Reveals



Transfer Measurements



Align / Square Your Projects



Set Bit / Blade Heights



Level Your Work



Kreg Tools Cutting and Measuring

Precision Trak & Stop Kit ITEM# KMS8000 \$124.00



Includes:

Four 2' (610mm) pieces of Trak, one Swing Stop™, one Production Stop, one 12' (3675mm) length of L-R reading self-adhesive tape, one 12' (3675mm) length of R-L reading self-adhesive tape, detailed instructions, and mounting hardware.

SPECIFICATIONS

Fence	Finish	Weight	Length	Measuring Tape
Aircraft-grade aluminum	Anodized for easy clean-up	7 lbs. (3.2kg)	(4) 2' sections for 8' of Trak length (610mm for 2440mm)	(1) 12' (3675mm) R to L Reading (1) 12' (3675mm) L to R Reading

A PRODUCTION STOP
Designed to stand up to the rigors of repetitive cuts in an industrial environment, the Production Stop mounts onto the top of the fence and features dual lens cursors for convenient use on either side of the blade.

B SWING STOP™
Our innovative Swing Stop™ features specially designed bushings that actively reduce 'play' in the stop, dramatically increasing accuracy. The stop itself easily sets the distance between the end of the board and the saw blade for cutting accuracy and repeatability... and flips out of the way when not in use.



C RIGID ALUMINUM FENCE
Incredibly strong and built to last, our anodized aluminum Trak features an L-shaped foot that makes alignment and mounting to any 3/4" (19mm) thick board a snap. Trak is designed with a groove across the top to accept the included self-adhesive measuring tape.

D SHOP-MADE SUPPORT WINGS
Build simple plywood or MDF extensions to match the height of your saw, then add a back fence that reaches 2 1/4" (57mm) above the saw height. Instructions and mounting hardware for the Trak are included.



Precision Miter Gauge

ITEM# KMS7102 \$139.00

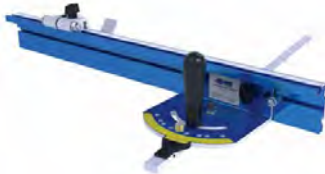

When you want to cut a different angle, the easy-to-use Vernier scale allows for fast adjustments to 1/10th of a degree.



Vernier Scale adjusts to 1/10th of a degree.

SPECIFICATIONS

Fence	T-Slot bar	Positive Stops at	Vernier Scale	Finish	Calibration	Weight
24" (610mm) aircraft-grade aluminum fence	24" (610mm) long, 3/8" (9mm) thick, 3/4" (19mm) wide	0, 10, 22 1/2, 30 & 45 degrees	Adjusts to 1/10th degree	Anodized for easy clean-up	Factory-calibrated right out of the box	6.5 lbs. 2.95 kg.

BUYING OPTIONS

Precision Miter Gauge System

Precision Miter Gauge, 24" (610mm) aluminum fence, and Swing Stop™.



\$139.00 ITEM# KMS7102

Precision Miter Gauge

Precision Miter Gauge only.



\$98.00 ITEM# KMS7101

FEATURES

A PRECISION LENS CURSOR
Similar to the type of lens found on a quality table saw rip fence, the clear lens features a high-visibility red line that makes it easy to set the Swing Stop™ for precise cuts, time after time.

B NO PLAY IN THE MITER SLOT
Our extremely straight 24" (610mm) anodized-aluminum bar is 3/8" (9mm) thick by 3/4" (19mm) wide and features five bar adjusters that eliminate "play" in the miter slot with the turn of a screw driver.



C SWING STOP™
Adds repeatable accuracy to your Miter-Gauge fence. This versatile Swing Stop™ holds your desired measurement precisely, and swings out of the way easily when you want to cut without it.

Kreg Tools Cutting and Measuring

Precision Band Saw Fence

ITEM# KMS7200 \$107.00

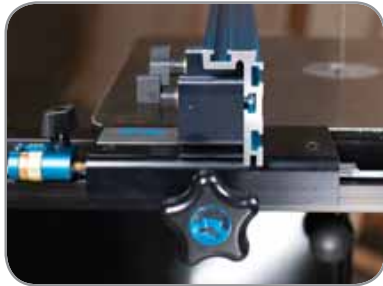

Compensate for blade drift by loosening two hex bolts and adjusting the angle of the fence.



Add a stop to the fence for repeat cuts to a set depth, such as cutting tenons.

SPECIFICATIONS

Fence	Precision Lens Cursor	Blade Drift	Dimensions	Finish	Weight	Adaptability
Aircraft-grade aluminum	Allows precise cuts	Two simple adjustments for blade drift	Mounting Rail is 26 (660mm) long Fence is 18 (457mm) long	Anodized for easy clean-up	8.75 lbs. (4 kg.)	Pre-drilled holes on the mounting rail fit most 14" (355mm) Band Saws

FEATURES

A RIGID DESIGN

The aluminum fence is incredibly strong, straight, and built to last for years. The face and top edge of the fence contain T-slots for adding stops, resaw guides, and more.

B EASY TO REMOVE

When you don't need the fence, remove it in seconds – no tools required!
Just loosen the locking knob and lift the fence from the mounting rail. The rail sits below your table's surface to stay out of the way.

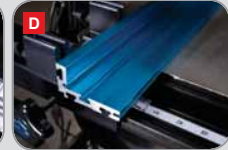

C PRECISION LENS CURSOR

Magnified and easy-to-read for even the smallest adjustments, the thin red line on the Precision Lens Cursor lets you accurately set up the fence for cutting veneer, tenons, and more.

D ADJUSTABLE IN 2 DIMENSIONS

This fence adjusts to set up perfectly square to your table and blade. Two simple adjustments allow you to set the fence to match blade drift, greatly enhancing cutting accuracy.

RECOMMENDED ACCESSORIES



\$15.99
ITEM# KMS7215

Precision Micro-Adjuster Add enhanced precision to every cut.



\$18.99
ITEM# KMS7213

4.5 Resaw Guide (114mm) Adjust for blade drift as you cut.



\$21.99
ITEM# KMS7214

7 Resaw Guide (178mm) Adjust for blade drift as you cut with wide workpieces.

Precision Stops



PRODUCTION STOP
ITEM# KMS7800 \$22.99

Built for rugged use. Dual lens cursors allow for use on either side of the blade. Fits on top of the Top Trak and Heavy-Duty Trak. Can be removed and repositioned easily.



SWING STOP™
ITEM# KMS7801 \$29.99

Add repeatable accuracy to your miter saw, band saw, table saw fence, router table, and more with this versatile Swing Stop.

Measuring Tapes

Imperial 12' Self-Adhesive Tape (3658mm)

#KMS7723 Tape (12' R-L reading) (3658mm) \$7.49

#KMS7724 Tape (12' L-R reading) (3658mm) \$7.49

Metric 3.5-Meter Self-Adhesive Tape (3500mm)

#KMS7728 Tape (3.5-meter, R-L reading) (3500mm) \$7.49

#KMS7729 Tape (3.5-meter, L-R reading) (3500mm) \$7.49

Trak Components

Jig and Fixture Bar (30") (762mm)

#KMS7303 \$23.99

Combo-Trak 48" (1219mm)

#KMS7448 \$39.99

Mini Trak 48" (1219mm)

#KMS7509 \$18.99

Top Trak

#KMS7712 (2' length) (610mm) \$21.99

#KMS7714 (4' length) (1219mm) \$34.99

Heavy-Duty Trak

#KMS7704 (4' length) (1219mm) \$59.99

Trak Klamp

#KMS7511 \$5.99

Kreg Jig® K4 ITEM# K4 \$99.00



Includes:

Kreg Jig® K4, 3/8" (10mm) stepped drill bit, 6" (152mm) square driver, starter Kreg® screw set, starter pocket-hole plug set, and owner's manual.

SPECIFICATIONS

Body Material	Number of Drill Guides	Drill Guide Spacings	Clamping Method	Workpiece Thickness Settings
Glass-Filled Nylon	3	9/16", 7/8" and 1-7/16" (14mm, 22mm, 36mm)	Toggle clamp for benchtop applications. Works with a variety of common clamps for repair applications.	1/2, 5/8, 3/4, 7/8, 1, 1 1/8, 1 1/4, 1 3/8, 1 1/2 (12mm, 16mm, 19mm, 22mm, 25mm, 29mm, 31mm, 35mm, 38mm)

FEATURES

3-HOLE DRILL GUIDE



LARGE CLAMPING RECESS



REMOVABLE DRILL GUIDE



MAKE IT A MASTER SYSTEM

Kreg Jig® K4MS
ITEM# K4MS \$139.00

- Kreg Jig® K4
- Stepped Drill Bit & Stop Collar
- 6" Square-Drive Bit
- Starter Screw & Plug Set
- Face Clamp
- Portable Base
- Material Support Stop
- Dust Collection Attachment



Material Support Stop



Dust Collection



Face Clamp



Portable Base

Kreg Tools Joining

Kreg Jig® K5 **ITEM# K5** **\$129.00**

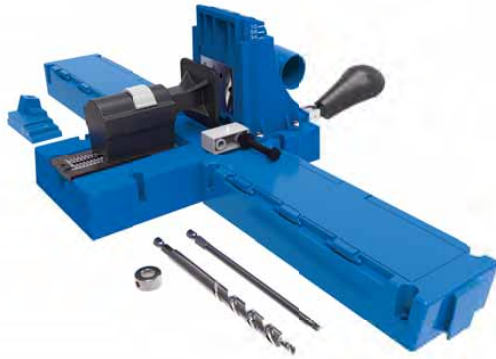

Includes:

Kreg Jig K5 base with ratcheting front-side clamp, extension wings, swiveling dust-collection port, drill guide block, spacer block, workpiece stop, drill bit setup block, stepped drill bit, 6" (152mm) driver bit, stop collar, Hex wrench, starter Kreg screw set, starter pocket-hole plug pack, owner's manual, online SkillBuilder videos, and three downloadable project plans.

SPECIFICATIONS

Body Material	Number of Drill Guides	Drill Guide Spacings	Clamping Method	Workpiece Thickness Settings
Glass-Filled Nylon	3	9/16", 7/8", 1-7/16" (14mm, 22mm, 36mm)	Ratchet Clamp on Benchtop Base	1/2", 5/8", 3/4", 7/8", 1", 1-1/8", 1-1/4", 1-3/8", 1-1/2" (12mm, 16mm, 19mm, 22mm, 25mm, 28mm, 31mm, 35mm, 38mm)

MAKE IT A MASTER SYSTEM

Kreg Jig® K5MS

ITEM# K5MS **\$159.00**

- Kreg Jig® K5
- Extension Wings with Storage
- Adjustable Workpiece Stop
- Stop-Collar Setting Block
- Stepped Drill Bit & 6" Square-Drive Bit
- Screw Selection Chart
- Starter Screw & Plug Set
- Automaxx® Face Clamp
- Portable Base
- Downloadable Project Plans



Portable Base



3 Downloadable Project Plans

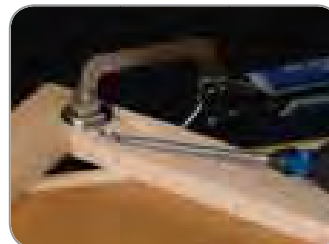

Automaxx® Face Clamp

Kreg Tools Joining

Kreg Jig® R3
ITEM# R3 \$39.00

SPECIFICATIONS

Body Material	Number of Drill Guides	Drill Guide Spacings	Clamping Method	Workpiece Thickness Settings
Glass-Filled Nylon	2	3/4 (19mm)	Works with a variety of common clamps. Clamp Pad Adapter accepts any Kreg Face Clamp.	1/2", 5/8", 3/4", 7/8", 1", 1-1/8", 1-1/4", 1-3/8", 1-1/2" (12mm, 16mm, 19mm, 22mm, 25mm, 29mm, 31mm, 35mm, 38mm)

FEATURES



Includes:
Kreg Jig R3, clamp adapter, stepped drill bit, 6" (152mm) driver bit, depth collar, Allen wrench, starter Kreg Screw set, starter pocket-hole plug set, and owners manual, all inside of a compact and durable carrying case.

A CLAMP PAD ADAPTER

The Kreg Jig® R3 can be secured to your workpiece with any standard bar clamp or C-clamp. In addition, the R3's Clamp Pad Adapter allows the jig to be attached directly to any Kreg® Face Clamp for faster and more-repeatable pocket holes.

B MATERIAL THICKNESS SETTINGS

From thin drawer boxes and craft projects to stout 2x4s, this jig can handle just about anything. Independent positioning sliders feature nine depth settings, allowing you to easily join materials from 1/2" (12mm) to 1-1/2" (38mm) thick in 1/8" (3mm) increments.



C ORGANIZED CARRYING CASE

The R3 comes in a durable carrying case to keep materials organized and to make sure that you always have the tools you need on hand. As a bonus, we've molded a depth setup gauge into the case for handy reference.

D EASY-PRESS™ POSITIONING SLIDERS

To properly set the jig, simply position the sliders on the side of the jig and move the sliders so that your material thickness is aligned with the arrow on the jig body to set your drilling depth.

Kreg Jig® HD

ITEM# KJHD \$59.00

SPECIFICATIONS

Body Material	Number of Drill Guides	Drill Guide Spacings	Workpiece Thickness Settings
Glass-Filled Nylon	2	1-7/16" (36mm)	1 1/2" (38mm)



Includes:
HD Drill Guide, stop block, 1/2" (12mm)-diameter HD stepped drill bit, 6" (152mm) HD driver bit, stop collar, Hex wrench, starter Kreg Screw set, and owner's manual.



Heavy-Duty Screws:
The Kreg Jig® HD works with 2x4s and larger stock. It utilizes heavy-duty #14 hardened-steel screws that offer incredible shear-resistance and have three anti-corrosion layers for long-term corrosion resistance.

It Works Wherever You Do:



Whether you're framing walls, building deck railings, backyard furniture, fences, benches, or any other large project, you always want the strongest joint possible. This is where the Kreg Jig HD excels in strength.

Kreg Tools Joining

Kreg Jig® Mini

ITEM# MKJKIT \$19.00



Includes:
Kreg Jig Mini, stepped drill bit, depth collar, and Allen wrench.

SPECIFICATIONS

Body Material	Number of Drill Guides	Clamping Method	Workpiece Thickness Settings
Glass-Filled Nylon	1	Works with a variety of common clamps or any Kreg Face Clamp.	1/2" (12mm) to 1 1/2" (38mm)



PLUG-SETTING FEATURE
The Mini's plug setting feature is fast, easy, and safe.



UNLIMITED MATERIAL THICKNESS
The Kreg Jig Mini has a fenceless design that allows you to make precise angle and stock-depth adjustments as needed.

Kreg Jig® Accessories

Kreg System Organizer

ITEM# KTC55 \$39.99



Durable construction
with impact-resistance



Generous size
to keep all accessories close at hand



Transparent lid
for easy visual inventory



Removable section
for storage versatility

Micro-Pocket™ Drill Guide

ITEM# KJD/MICROBIT \$16.99



Includes:
Micro-Pocket™ Drill Guide, Kreg® Micro drill bit, stop collar, hex wrench, and sample pocket-hole screws.

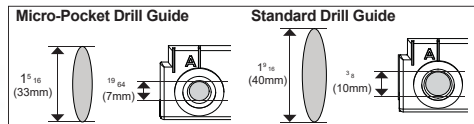

SPECIFICATIONS

Body Material	Number of Drill Guides	Drill Guide Spacings	Workpiece Thickness Settings
Glass-Filled Nylon	3	9/16", 7/8", 1 1/16" (14mm, 32mm, 36mm)	1/2", 5/8", 3/4", 7/8", 1", 1 1/8", 1 1/4", 1 3/8", 1 1/2" (12mm, 16mm, 19mm, 22mm, 25mm, 28mm, 31mm, 35mm, 38mm)



Endless Applications



Perfect for 1/2" (12mm) Stock



Perfect for Narrow Stock



Compatible with the Kreg Jig® K3, K4, and K5

Deck Jig™

ITEM# KJDECKSYS \$79.00

With the Kreg Deck Jig and a few simple tools you already own, you can create a beautiful, functional deck surface that is completely free of exposed fasteners and painful splinters. Concealed-decking systems utilize awkward steel fasteners or thin plastic clips to hold your deck boards in place. The Kreg Deck Jig utilizes a more straightforward approach, creating an incredibly strong wood-to-wood bond through precisely-placed self-tapping screws.

Includes:

Deck Jig, instructional DVD, 100 Protec-Kote deck screws, 6" (152mm) Deck Jig drill bit, 6" (152mm) KTX square driver bit, (3) 5/16" (8mm) Deck Jig™ spacer rings, (3) 1/4" (6mm) Deck Jig spacer rings, (2) stop collars, hex wrench, and a durable carrying case.



FEATURES

FUNCTIONAL

An oversized, ergonomic, easy-grip handle gives you a secure hold and complete control over each and every hole you drill.



PRECISE

Three hardened-steel Kreg drill guides keep the specialized stepped drill bit and driver bit at the precise, optimal angle.



ACCURATE

Six handy spacer rings—three 1/4" (6mm) and three 5/16" (8mm)—ensure accurate deck board spacing for proper drainage and a longer deck life.



HOW IT WORKS

DRILL.

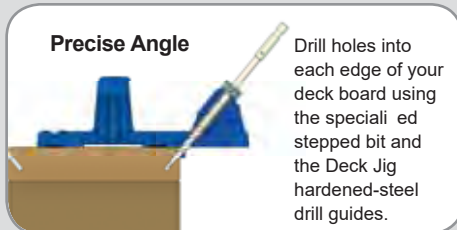

DRIVE.

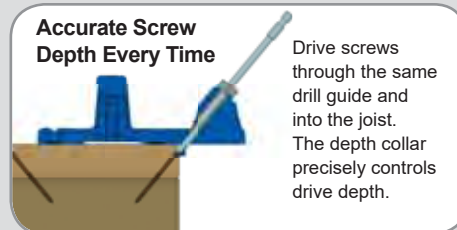

DONE!

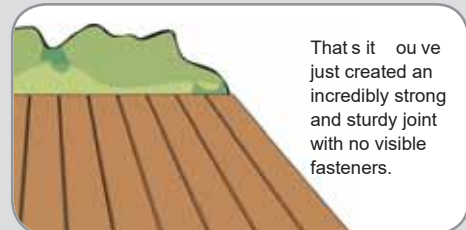

RECOMMENDED ACCESSORIES



ITEM#
KJD/DECKBIT
\$16.99 and
DECKDRIVER
\$4.99

Deck Jig™ Drill Bit / Driver Bit The Deck Jig drill bit and driver bit both feature hardened-steel construction and Quick-Change compatible hex shanks. Both bits are designed to work exclusively with the Kreg Deck Jig and come complete with a depth collar and hex wrench to help control your plunge depth.



#DECKSPACER-BLUE
\$9.99
#DECKSPACER-RED
\$9.99

Deck Jig™ Spacer Rings Ensure a consistent spacing 5/16" (8mm) or 1/4" (6mm) between your deck boards while you drive your screws to secure the board. Rings feature a large handle for quick placement. Works with the Kreg Deck Jig. Available in two sizes: 5/16" (8mm) (blue) or 1/4" (6mm) (red). Set of 12.



ITEM# KJHD
\$59.00

Kreg Jig® HD
If you build a lot of outdoor projects and work with 2x4s and larger stock, this is the Kreg Jig for you. The Kreg Jig HD has a bigger bit and utilizes bigger 14 screws, so that you can build bigger and stronger projects. See page 18.

Kreg Jig® Accessories

Kreg Jig® Portable Base

\$19.99



Accepts your Kreg Jig Drill Guide Block and connects to most Kreg Face Clamps for portable pocket holes. Allows your jig to be used as two tools in one: a sturdy benchtop jig and a portable jig for work on the go.

ITEM# KPDGB



Material Support Stop

This handy Kreg Jig accessory can be positioned any distance from your Kreg Jig to repeat the same pocket holes. Can also be swung out of the way to serve as a support for large panels.



\$9.99

ITEM# KJSS

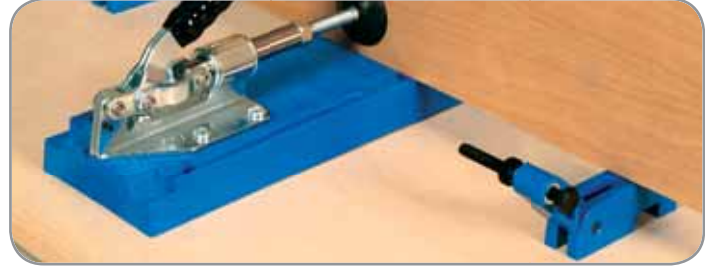

Dust Collection Attachment

\$9.99



This handy attachment connects any standard 1/4" (32mm) vacuum hose to your Kreg Jig for faster drill strokes and a cleaner shop. Only for use with the Kreg Jig K3, K4, and Kreg Jig K4 Master System.

ITEM# KJDCA



Drill Guide Spacer Blocks

Drill Guide Spacer Blocks make it quick and easy to compensate for additional material thickness in 1/4" (6mm) increments. Works with the Kreg Jig K3, K4, K4MS, K5 and K5MS. Set of 3.



\$9.99

ITEM# KDGADAPT



Drill Bits

Kreg drill bits feature a one-piece design that eliminates clogging and provides a much smoother, faster drilling stroke than the drill bits with replaceable center drills. The KJD Bit for our manual Kreg Jigs is made of high-speed steel, while the DKDB machine bit is made of cobalt-steel to increase bit life. Because the DKDB bit is 3/8" (10mm) in diameter, it can be used in any manual Kreg Jig as a premium replacement. Be sure to order the left-handed drill bit (LH-DKDB) for the center spindle of the DK3100 fully-automatic machine.

- #DKDB \$34.99** For DK1100, DK3100, and DK5100
- #LH-DKDB \$39.99** For DK3100 Center Spindle (Left Hand)
- #KJD \$16.99** For Kreg Jigs®
- #KJDHD \$19.99** For Kreg Jig® HD (not shown above)
- #KJSC/D \$2.49** Depth Collar / Allen Wrench (not shown above)
- #KJSC/MICROBIT \$2.49** Micro-Pocket Depth Collar / Allen Wrench

Quick-Change Drill Bit

ITEM# QUIK-BIT \$17.99

Designed specifically for Kreg Joinery™. Standard 1/4" (6mm) Hex Shank works with any standard quick-change chuck.

Quick-Change Kit **ITEM# QUIK-KIT \$29.99**

This simple kit provides everything you need to switch from drilling pocket holes to driving pocket screws in just seconds.

Includes:

- Quick-Change chuck
- 2 square driver
- Hex shank pocket hole bit
- Depth collar / Allen wrench



Drivers

Kreg square-drive bits have deep tips that greatly reduce cam-out when driving screws. 2 drivers (for all except HD screws) come in 3" (76mm) and 6" (152mm) lengths. The 6" length is easiest to use in most applications, while the 3" is perfect for working in tight spots. The 3 HD (Heavy Duty) driver comes in 6" length.

- #DDS \$4.49** 3" (76mm) & 6" (152mm), #2 Square Driver Set (2)
- #D6X2 \$5.49** 6" (152mm), #2 Square Driver Set
- #D6HD \$5.99** 6" (152mm), #3 Square Driver for Kreg Jig® HD
- #D6HT \$3.75** 6" (152mm), #2 Square Driver With Hardened Tip
- #D3HT \$2.75** 3" (76mm), #2 Square Driver With Hardened Tip

Kreg® Screws

Kreg screws are built with specialized features that work together to ensure the strongest joint possible. They also make driving easy and help to reduce wood splitting. Choosing Kreg Screws will give you the best results possible. To get these great results, you need to choose the best Kreg screw for your particular project. Choosing the right screw is easy once you understand the features of each screw type and how these features will impact the success of your project.

Head Style

Unlike basic drywall screws with wedge-shaped heads prone to wood-splitting, Kreg screws have large flat heads that are designed to seat firmly in the bottom of pocket holes. This dramatically improves overall joint strength and prevents your wood from splitting. Kreg screws are available in two head styles:



MAXI-LOC
These washer-head screws are recommended for the majority of applications. The large head provides maximum bearing surface, helping to ensure the strongest joint possible.



PAN-HEAD
The smaller head of pan-head screws makes them the preferred choice for extremely hard woods and 1/2" stock. These screws also feature a smaller shank diameter, which reduces the chance of wood-splitting. Work with Kreg standard and Micro Drill Guides.

Thread Style

Kreg Screws are available in three different thread styles, all of which feature a self-tapping tip. This allows the screw to drill its own hole while being driven, eliminating the need to drill a pilot hole in the adjoining workpiece. This feature also works to prevent your wood from splitting.



FINE THREAD Fine-thread screws are the preferred choice for hardwoods.
Ash | Maple | Hickory | Mahogany | Oak | Walnut | Cherry | Birch



COARSE THREAD Coarse-thread screws are the preferred choice for softwoods.
Plywood | Particle Board | MDF | Melamine | Pine | Cedar | Fir | Spruce | Basswood | Butternut | Aspen

Composition

Durable case-hardened steel ensures that you get the strongest joint possible, and that your screw will spin out in the hole before the head ever breaks off. Kreg Screws are available in three finishes:



Our zinc-coated screws are recommended for a wide variety of indoor projects where exposure to moisture is not a significant concern.



Blue-Kote screws feature three anti-corrosion layers, perfect for indoor and outdoor projects. They provide rust-resistance up to 400% greater than zinc-plated screws and work with pressure-treated material.



Our stainless screws are specially designed for high-moisture applications, excessive exposure to water, and other exceedingly corrosive environments, such as ACQ-treated lumber.

Length

Selecting the correct screw length is the most important part of choosing the right screw for your application. As a general rule, we suggest using the screw lengths shown when joining like material thicknesses, such as 3/4" (19mm) to 3/4" (19mm) material.

The fully-threaded design of most standard screws can push workpieces apart as they are being tightened. The unique design of Kreg Screws eliminates this problem and ensures that the joint pulls tightly together.

Watch an online video at kregtool.com for help choosing the best screw for your application.

Material Thickness	1/2" (12mm)	1/2" (12mm)	5/8" (16mm)	3/4" (19mm)	7/8" (22mm)	1" (25mm)	1 1/8" (29mm)	1 1/4" (32mm)	1 3/8" (35mm)	1 1/2" (38mm)
Screw Length	3/4" (19mm)	1" (25mm)	1" (25mm)	1 1/4" (32mm)	1 1/2" (38mm)	1 1/2" (38mm)	1 1/2" (38mm)	2" (51mm)	2" (51mm)	2 1/2" (64mm)

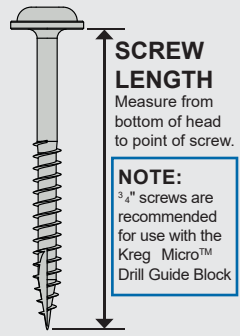

SCREW LENGTH
Measure from bottom of head to point of screw.

NOTE:
3/4" screws are recommended for use with the Kreg Micro™ Drill Guide Block

Item Number Key

SML-F125-100

Head Style	Thread Type	Length	Quantity
SML Maxi-Loc	F Fine	1 1" (25mm)	50
SPS Pan Head	C Course	125 1 1/4" (32mm)	100
		150 1 1/2" (38mm), etc.	etc.

Your **KREG®** projects demand **KREG®** Screws.

Learn why at kregtool.com/kreg screws

5 Reasons Kreg Screws Give you the Best Results

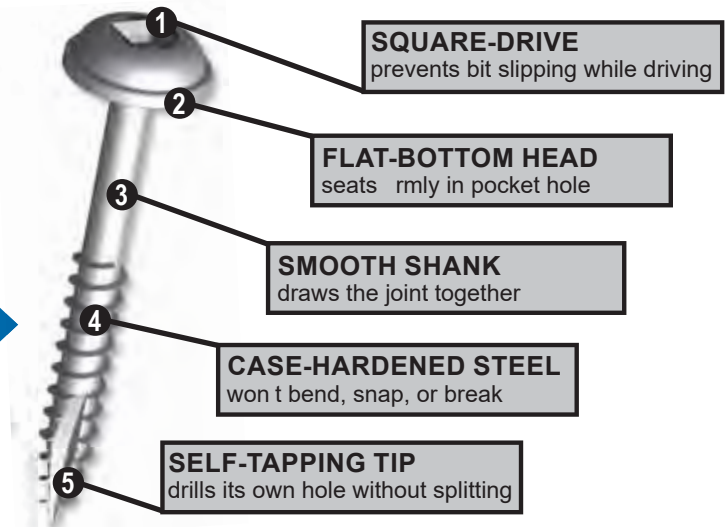

Part#	Thread	Length	Head Style	Qty. & Price	Diameter
SML-C1	Coarse	1" (25mm)	Maxi-Loc™	100, 500, 1000 (\$4.49, \$17.99, \$26.99)	#8
SPS-C1	Coarse	1" (25mm)	Pan Head	100, 500, 1000 (\$4.99, \$17.99, \$26.99)	#6
SML-C125	Coarse	1¼" (32mm)	Maxi-Loc™	100, 500, 1000, 5000 (\$4.69, \$18.89, \$27.99, \$74.99)	#8
SML-C150	Coarse	1½" (38mm)	Maxi-Loc™	100, 500, 1000 (\$5.19, \$20.99, \$31.49)	#8
SML-C2	Coarse	2" (51mm)	Maxi-Loc™	50, 250, 3000 (\$3.69, \$16.69, \$64.99)	#8
SML-C250	Coarse	2½" (64mm)	Maxi-Loc™	50, 250, 2000 (\$5.19, \$18.89, \$59.99)	#8
SPS-F075	Fine	¾" (19mm)	Pan Head	100, 500, 1000 (\$4.19, \$16.79, \$26.99)	#6
SPS-F1	Fine	1" (25mm)	Pan Head	100, 500, 1000 (\$4.49, \$17.99, \$26.99)	#6
SML-F125	Fine	1¼" (32mm)	Maxi-Loc™	100, 500, 1000, 5000 (\$4.69, \$18.89, \$27.99, \$74.99)	#7
SPS-F125	Fine	1¼" (32mm)	Pan Head	100, 500, 1000, 5000 (\$4.69, \$18.89, \$27.99, \$74.99)	#6
SML-F150	Fine	1½" (38mm)	Maxi-Loc™	100, 500, 1000 (\$5.19, \$20.99, \$31.49)	#7
SPS-F150	Fine	1½" (38mm)	Pan Head	100, 500, 1000 (\$5.19, \$20.99, \$31.49)	#6



Part#	Thread	Length	Head Style	Qty. & Price	Diameter
SML-C125S5	Coarse	1¼" (32mm)	Maxi-Loc™	100 (\$18.99)	#8
SML-C150S5	Coarse	1½" (38mm)	Maxi-Loc™	100, 1000 (\$20.99, \$136.49)	#8
SML-C250S5	Coarse	2½" (64mm)	Maxi-Loc™	50, 250, 2000 (\$25.99, \$104.99, \$417.99)	#10
SML-F125S5	Fine	1¼" (32mm)	Maxi-Loc™	100 (\$19.99)	#7

Part#	Thread	Length	Head Style	Qty. & Price	Diameter
SML-C2X250	Coarse	2½" (64mm)	Maxi-Loc™	30, 125 (\$5.49, \$19.99)	#14



Part#	Thread	Length	Head Style	Qty.	Diameter
SML-C125B	Coarse	1¼" (32mm)	Maxi-Loc™	100, 1000 (\$6.29, \$37.89)	#8
SML-C150B	Coarse	1½" (38mm)	Maxi-Loc™	100, 1000 (\$6.79, \$136.49)	#8
SML-C2B	Coarse	2" (51mm)	Maxi-Loc™	50, 250, 3000 (\$4.49, \$16.79, \$74.99)	#8
SML-C250B	Coarse	2½" (64mm)	Maxi-Loc™	50, 250, 2000 (\$5.79, \$20.99, \$64.99)	#8

Screw Kit

This kit contains five of the most popular self-tapping screw sizes for Kreg Joinery in a durable, easy-to-carry case.



ITEM# SK03
\$29.99

Included:	QTY.
SPS-F1	150
SPS-C1	150
SML-F125	150
SML-C125	150
SML-C250B	75

Blue-Kote™ Screw Kit

This kit contains four of the most popular, weather-resistant screws in a durable, easy-to-carry case. Perfect for outdoor use.



ITEM# SK03B
\$39.99

Included:	QTY.
SML-C125B	100
SML-C150B	100
SML-C2B	100
SML-C250B	150





Pocket-Hole Plugs

For those times when pocket holes won't be hidden on the backside of your project or you want to highlight them decoratively, use Kreg Pocket-Hole Plugs. Plugs are offered in seven solid wood species, and five plastic plug colors for use on laminated surfaces.

Wood Plugs

Available in Quantities of:

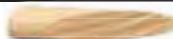
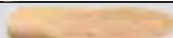
Price

P-MAP		MAPLE	50	\$6.99
P-WAL		WALNUT	50	\$6.99
P-OAK		OAK	50	\$6.99
P-PIN		PINE	50	\$6.99
P-CHE		CHERR	50	\$6.99
P-CDR		CEDAR	50	\$6.99
P-PNT		PAINT GRADE	50	\$4.99

Plastic plugs

Plastic Plugs are great for laminated surfaces and come in five colors.

Available in quantities of: Price

CAP-BRN		BROWN	50	\$6.99
CAP-BLK		BLACK	50	\$6.99
CAP-WHT		WHITE	50	\$6.99
CAP-ALM		ALMOND	50	\$6.99
CAP-LTB		LIGHT BROWN	50	\$6.99

Deck Screws



How many screws will you need?

# of Screws	Size of Deck
700 Screws	10 x 20 Deck (3mx6m)
1,400 Screws	20 x 20 Deck (6mx6m)
2,100 Screws	20 x 30 Deck (6mx9m)

*Based on 16" joist spacing.



Stainless 2" (50mm) Deck Screws

To provide the ultimate protection, choose stainless. Stainless screws provide the best protection against corrosion in the long-term. Available in 100 ct. and 700 ct. packages.

100 ct.
ITEM# SDK-C2SS-100
~~\$17.99~~

700 ct.
ITEM# SDK-C2SS-700
~~\$109.99~~
(Driver Bit included)



Protoc-Kote™ 2" (50mm) Deck Screws

These 2"-long Protoc-Kote deck screws are designed for use with 4/4 and 5/4 decking material, and work with the Kreg Deck Jig. Protoc-Kote features three anti-corrosion layers that are chemically combined to provide strong protection against rust and corrosion in many common outdoor applications. Perfect for ACQ-treated lumber. Available in 100-count and 700-count packages.

100 ct.
ITEM# SDK-C2W-100
~~\$7.49~~

700 ct.
ITEM# SDK-C2W-7003
~~\$49.99~~
(Driver Bit included)



Protoc-Kote™ 2 5/8" (67mm) Deck Screws

These deck screws are designed for use with the Kreg Deck Jig and 2x decking, or as a general fastener for a wide variety of deck projects. Protoc-Kote features three anti-corrosion layers chemically-combined to provide strong protection against rust and corrosion in many common outdoor applications. Perfect for ACQ-treated lumber. Available in 100-count and 525-count packages.

100 ct.
ITEM# SDK-C262W-100
~~\$11.99~~

525 ct.
ITEM# SDK-C262W-525
~~\$59.99~~
(Driver Bit included)



Looks Better

Get the deck you want, without unsightly exposed fasteners. Kreg screws are driven at an angle into the edge of your deck boards so they stay hidden from view.

Lasts Longer

Seasonal changes can force traditional fasteners out of place with time. Kreg Deck Screw heads stay safely below the surface, for a longer-lasting deck.

More Comfortable

Bare feet Don't worry. By coupling the Kreg Deck Jig with composite decking, you'll get a deck free of cracks, splinters, and "pop-out" fasteners.

Kreg Tools Pocket-Hole Machines

Foreman

ITEM# DB210 \$399.00

SPECIFICATIONS

Motor	Drill Bits	Cycle Time	Material Clamping Capacity	Hole Centering Capacity	Weight	Dimensions	Warranty
110-volt	Comes with standard Kreg stepped drill bit. Also accepts Kreg Micro and HD drill bits.	1 second	1 1/2 (38mm)	1/2 (12mm) material to 1 1/2 (38mm) material	approx. 20 lbs.	Tabletop: 14" (355mm) x 23 1/2" (597mm) Entire Unit: 15"H x 19"L x 29.5"D (380mm)H x (482mm)L x (750mm)D	1 year Limited Warranty

FEATURES



Includes:

Foreman Pocket-Hole Machine, adjustable fence with spring-loaded stops, dust-collection attachment, Kreg stepped drill bit and drill guide, drill bit setting block, 6" (152mm) square-drive bit, and owner's manual.

RECOMMENDED ACCESSORIES

Kreg Screws & Plugs

Use genuine Kreg® Screws for great results. Kreg® has the Standard, Micro-Pocket™, and HD (Heavy-Duty) Screws you need to get the job done. Then, fill your pocket holes with Kreg® pocket-hole plugs, which are available in seven wood species and in five colors of plastic.

Standard Foreman Bit

Keep a standard replacement bit on hand, just like the 3/8" (10mm) diameter one that comes with your Foreman.

Standard Replacement Bit without Drill Guide
ITEM# QUIK-BIT \$17.99



DRILLS ALL 3 KREG® JOINTS

The all-new Foreman is the first Kreg® Pocket-Hole Machine that can drill all three types of Kreg Joints™: Standard for materials from 1/2" (12mm) to 1 1/2" (38mm) thick, Micro-Pocket™ to create more compact pocket holes in thinner stock, and HD (Heavy-Duty) for creating strong joints in 1 1/2" (38mm) and thicker stock.



ADJUSTABLE FENCE & STOPS

To ensure perfect pocket-hole placement, the Foreman features a tool-free adjustable fence that positions your workpiece for precise pocket depth, and a pair of adjustable, spring-loaded stops that provide repeatable accuracy.



POWERFUL MOTOR & QUICK-CHANGE CHUCK

One pull of the handle starts the powerful 110-volt motor for fast drilling, and a quick-change chuck allows fast, tool-free bit changes. Easily switch from Kreg® Standard, Micro-Pocket™, and HD (Heavy-Duty) bits for different project needs.

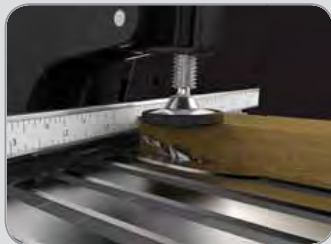

PERFECT POCKET-HOLE PLACEMENT

Foreman users will be amazed at how quickly and easily they can drill perfect pocket holes time and time again. Because the drill bit enters the workpiece from below, it stops at the precise pocket depth each time.



STRAIGHTFORWARD OPERATION

Simply pull the handle to start the powerful 120-volt motor, clamp your workpiece securely in place, and drill perfect pocket holes. Innovative features and straightforward operation give you a versatile, affordable, high-speed solution for pocket-hole construction.



BUILT-IN STORAGE & DUST COLLECTION

A handy dust collection attachment will keep your work area clean. Once you're ready to get to work, the cast-aluminum tabletop offers ample work space. Plus, underneath the tabletop is a built-in storage tray—the perfect place to store extra bits and accessories.

HD Accessories

HD the accessory to have when you want to BUILD BIG. You can build outdoor projects, construct strong deck rails, and even frame walls. Coated 14 screws create super-strong joints. You'll need the bit and drill guide to get started. Replacement bit is also available.



HD Drill Bit with Drill Guide #DB210-HDBB

\$31.99



HHD Replacement Bit without Drill Guide ITEM# DB210-HDB

\$19.99

Micro Accessories

Micro great when you want the smallest pocket joint possible. Perfect for adding detail, building cabinet frames, doors and drawers, and for smaller projects. You'll need the bit and drill guide to get started. Replacement bit also available.



Micro Drill Bit with Drill Guide \$26.99

ITEM# DB210-MBB

Kreg Tools
Clamping Tools
Automaxx® Face Clamps

Automaxx® Face Clamp
 has a 3" (76mm) reach and handles materials up to 27/8" (73mm) thick.



ITEM #KHC-1410 \$29.99

Automaxx® Large Face Clamp
 has a 6" (152mm) reach and handles materials up to 4 1/4" (108mm) thick.



ITEM #KHC-1420 37.99



Automaxx® Bench Klamps™ &
Automaxx® Bench Klamp System™



Automaxx® Bench Klamp™
 has a 3" (76mm) reach and handles materials up to 2 1/2" (64mm) thick.



ITEM # KKS1120
\$37.99

Automaxx® Large Bench Klamp™
 has a 6" (152mm) reach and handles materials up to 4 1/4" (108mm) thick.



ITEM # KKS1140
\$43.99

Automaxx® Bench Klamp System™
 This 360° Auto-Adjust bench-top clamping station includes a 3" (76mm) Bench Klamp™ & Klamp Plate™.



ITEM # KKS1110
\$49.99

Automaxx® Heavy-Duty Bench Klamp System™
 includes a 10" (254mm) x 10" (254mm) x 1/4" (6mm) steel plate, Bench Klamp™, mounting hardware, and rubber feet.



ITEM# KKS-1115
\$64.99

Klump Table™ with Automaxx®
ITEM# KKS2100 \$399.00

SPECIFICATIONS

- **Large 21-34" (552mm) x 33-3/4" (857mm) clamping surface.
- **Replaceable, glue-resistant melamine surface.
- **Klump Trak™ on two sides of the table provides endless exhibility.
- **Klump Blocks™ allow for fast, accurate, and consistent registration of work pieces
- **Can be used for a variety of woodworking functions, including sanding, routing, and layout

Multi-Purpose Shop Stand

- Heavy-duty 12- & 16-gauge steel
- Adjustable: 29" (737mm) to 35" (889mm)
- Four stable leveling feet
- Highly durable powder-coated steel
- Fast and easy assembly



ITEM# KKS2100
\$399.00



ITEM# KKS1500
\$249.00



ITEM# KRS1035
\$149.00



ITEM# PRS3090
\$59.99

Klump Table™ and Steel Stand Combo with Automaxx®

The Klump Table™ with Automaxx® combines several of our Klump System™ components into one amazing clamping station.

Klump Table™ with Automaxx®

The Klump Table™ with Automaxx® is the ultimate clamping solution for Kreg Joinery™, and works with the entire family of Klump System™ components.

Multi-Purpose Shop Stand

The Kreg® Multi-Purpose Shop Stand is the perfect foundation for all Kreg table top solutions, including the Klump Table™ and the Precision Router Table Top.

Heavy-Duty Casters

Add mobility to your Multi-Purpose Shop Stand. Includes four heavy-duty casters. Dual-locking mechanism protects against caster roll and pivot. Weight capacity is 150 lbs. each. Includes all necessary hardware.

Kreg Tools Clamping Tools

Klamp Vise™ with Automaxx®
ITEM# KKS1160 \$59.99



Includes:

Automaxx Bench Klamp, Klamp Vise Plate, 2 Klamp Blocks, 2 Bench Dogs, 2 Bench Brakes, installation hardware and instructions.



Strong and secure hold.
Up to 400 pounds of pressure.



Quickly remove or reposition your Automaxx® Bench Klamp™.



Fast and easy clamping – just grip and release.

RECOMMENDED ACCESSORY



ITEM# KKS1070 \$7.99

Bench Dogs

Two Bench Dogs are included. Made from ultra-durable, glass-reinforced nylon. Built-in painter's points for finishing applications.

Bench Brakes

Ultra-sticky rubber bumpers keep your workpieces from slipping, sliding, and shifting. Attach Bench Brakes to the top of your Bench Dogs or directly to your work surface.

KlampSystem™ Components



ITEM# KBK-IP \$12.99

Klamp Plate™

Add a clamping station almost anywhere you need one. Includes plate and mounting hardware. Compatible with standard Kreg Bench Klamps and Automaxx Bench Klamps.



ITEM# KKS1020 \$44.99

Klamp Trak™

The Klamp Trak lets you turn an entire workbench or sawhorse into a clamping station. Includes one 33³/₄" (857mm) aluminum extrusion. Compatible with standard Kreg Bench Klamps and Automaxx Bench Klamps.



ITEM# KKS1030 \$14.99

Klamp Blocks™

The Klamp Block Set lets you quickly and accurately register your workpieces and align your project for quick and easy squaring. Especially useful for face-frame construction. Made from durable, impact-resistant plastic. Includes 5 plastic blocks and mounting hardware.

Face Clamps™



Face Clamp™

Best for the majority of pocket-screw applications. 3" (76mm) reach will handle workpieces up to 2-3/4" (70mm) thick.



ITEM# KHC-PREMIUM \$22.99

Large Face Clamp™

Good for applications where a longer reach is needed. 6" (152mm) reach will handle workpieces up to 5" (127mm) thick.



ITEM# KHC-LARGE \$31.99

Kreg Tools Clamping Tools

Universal Clamp Trak™ Kits

Features:

- Heavy-duty anodized aluminum construction
- .695" (17mm) thickness allows Trak™ to sit just below a 3/4" (19mm)-thick surface
- Works with Automaxx Bench Klamps
- Works with Standard Bench Klamps
- Works with Klamp Blocks



Cutting



Routing



Pocket-Hole Construction



Sanding



General Hold Down

BUYING OPTIONS

27" x 45" (686mm x 1143mm) Universal Clamp Trak™ Kit

Item KKS2745 **\$99.99**

- Fits workbenches 30" x 48" (762mm x 1219mm) and larger
- Note: Kit is compatible with Kreg Universal Bench (page 50)—20" x 44" (508mm x 1117mm) or 28" x 44" (711mm x 1117mm)

System Includes

- (1) 27" (686mm) Trak™
- (1) 45" (1143mm) Trak™
- Mounting Hardware
- Installation Instructions

27" x 69" (686mm x 1752mm) Universal Clamp Trak™ Kit

Item KKS2769 **\$139.99**

- Fits workbenches 30" x 72" (762mm x 1829mm) and larger
- Note: Kit is compatible with Kreg Universal Bench (page 50)—20" x 64" (508mm x 1625mm) or 28" x 64" (711mm x 1625mm)

System Includes

- (1) 27" (686mm) Trak™
- (1) 69" (1143mm) Trak™
- Mounting Hardware
- Installation Instructions

Right Angle Clamp

ITEM# KHC-RAC

\$28.99



90° Corner Clamp

ITEM# KHC-90DCC

\$36.99



FEATURES

A CLAMP USING THE POCKET-HOLE

The steel pin on one arm of the clamp is shaped to fit snugly into a pocket hole, securely anchoring one workpiece against the other for easy assembly. Just drive a screw in an adjacent pocket hole while the Right Angle Clamp holds the pieces for you.

B SWIVEL PAD

On the arm opposite the pin, this clamp features a pad capable of swiveling to adjust to the dimensions of your material, so you can count on solid clamping without a chance of the joint shifting.

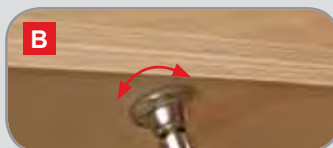

C ULTRA WIDE REACH

Whether you're joining two thin drawer sides or thicker materials to frame an outdoor project, the Right Angle Clamp opens wide to get the job done.

D USE TWO CLAMPS

Many woodworkers find it handy to use two Right Angle Clamps when assembling large workpieces. Place a clamp on each end to hold the parts while you drive screws in the remaining pocket holes.

Kreg Tools

Precision Routing Systems

Precision Benchtop Router Table

ITEM# PRS2100 \$229.00



SPECIFICATIONS

Insert Plate Dimensions	Table Surface	Fence Length	Fence material	Overall Dimension	Weight
9 ¹ / ₄ " (235mm) x 11 ³ / ₄ " (298mm) x 3 ⁵ / ₈ " (9mm) with Level-Loc Reducing Rings	16" x 24" x 1" (406mm x 609mm x 25mm)	24" (610mm)	Aircraft-grade aluminum Anodized for easy cleanup	20" H x 28 ¹ / ₄ " W x 20 ¹ / ₄ " D (508mm)H x (717mm)W x (514mm)D	26 lbs. (12kg)

FEATURES

A EASY-SLIDE™ ROUTER TABLE TOP

This router's tabletop features the same Easy-Slide skin, made from the same impact-resistant, high-pressure laminate that is used on our full-size router table. This skin allows workpieces to glide across the table's surface easily.

B BUILT FOR INDUSTRY PROFESSIONALS ON-THE-GO

This portable router table is built to withstand years of heavy use on the job site. It features a rugged steel foundation, four hard-wearing rubber feet, a tough tabletop made from impact-resistant surface, and a rigid aluminum fence, that are all built with mobile professionals in mind.



C BUILT-IN JOINTER

Fully-independent fence faces and depth-setting rods quickly turn your portable router table into a vertical jointer. Depth rods are stored on the fence and can be positioned behind the faces, allowing for jointing depth adjustments of 1/16" (2mm) and 1/32" (.80mm).



D FULL-SIZE LEVEL-LOC INSERT PLATE & LEVELERS

This full-size insert plate is the same one used in the large Kreg router table, which means you never have to compromise on functions or features. The plate is equipped with Level-Loc Reducing Rings that simply twist into place and lock in level and flush with the plate surface every time. Three rings are included: 1" (25mm), 1 3/16" (20mm) (for use with universal-style guide bushings), and 2 5/8" (16mm). The plate is mounted using Kreg Precision Insert Plate Levelers, making it easy to set the plate exactly flush with the table surface.

Precision Router Table System

ITEM# PRS1045 \$499.00

System Includes:

- Multipurpose, Self-Squaring Router Table Fence System
- High-Performance Table Top with Kreg's Precision Insert-Plate System
- Heavy-Duty, Adjustable Steel Stand



FENCE FEATURES

A TABLE SAW FUNDAMENTALS

Table saw-style T-square adjustment system that ensures the fence will always stay parallel to the miter-gauge slot. The fence adjusts easily with just one hand, and locks firmly in place with dual locks.

B UNPARALLELED PRECISION

Magnified measuring system with an adjustable measuring scale allows accurate setup with any bit. Included Micro-Adjuster allows you to dial in precision measurements exactly.

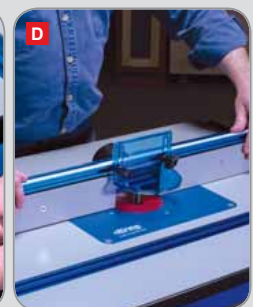

C BUILT-IN JOINTING FEATURE

Two jointing rods included with system. Just slide them into position behind the outfeed fence face, and the fence doubles as a jointer for putting perfect edges on boards.

D INDEPENDENT ADJUSTABLE FACES

Sliding fence faces can be positioned exactly where needed to provide workpiece support close to the bit, and to maximize chip collection into the fence's built-in dust port.

Kreg Tools

Precision Router Table System

ITEM# PRS1045 \$499.00

SPECIFICATIONS

Plate Opening Dimensions	Table Surface	Fence Length	Fence material	Overall Dimension	Weight	Multi-Purpose Shop Stand
3/8" x 9 1/4" x 11 3/4" (609mm x 235mm x 298mm)	24" x 32" (609mm x 813mm) with a 1"-thick (25mm) core	36 (914mm)	Heavy-duty anodized aluminum	36 1/2" H x 37 1/2" W x 25 1/2" D (927mm)H x (952mm)W x (648mm)D	85 lbs. (39kg)	Heavy 12- & 16-gauge steel construction Adjustable height: 29 (737mm) to 35 (889mm) 4 stable leveling feet Durable powder-coated finish Fast and easy assembly

TABLE FEATURES

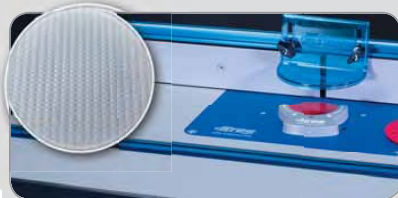

LOW-FRICTION EASY-SLIDE™ SURFACE

Durable, high-pressure laminate skin offers a low-friction Easy-Slide™ surface. Thick edgebanding protects the top against bumps and abrasions. Top is predrilled for holes for the Precision Insert-Plate Levelers.

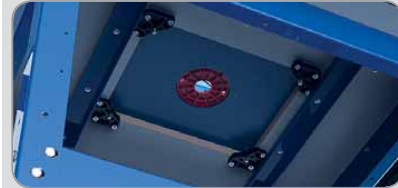

PRECISION COMBINED WITH DURABILITY

Four Precision Insert Plate Levelers allow you to set the plate flush for smooth, accurate routing. Steel reinforcing struts keep the 1" (25mm)-thick MDF table flat, even under the weight of heavy routers and lifts.



VERSATILE COMBINATION TRAK

Multipurpose trak works with standard 3/8" (10mm) x 3/4" (19mm) miter gauge guide bars. It also accepts Featherboards and other accessories, and is made from durable anodized aluminum.

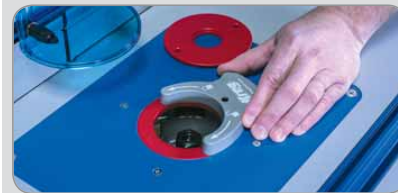

FEATURE-PACKED INSERT PLATE

Heavy-duty 3/8" (10mm) x 9 1/4" (235mm) x 11 3/4" (298mm) insert plate handles large routers with ease. Level-Loc Reducing Rings lock in level and flush with the plate surface using the included ring wrench. A brass starter pin ensures controlled bit contact during freehand routing.

BUYING OPTIONS



Multi-Purpose Shop Stand

Includes four (4) leveling feet and assembly hardware.
20" (508mm) x 28" (711mm)

#KRS1035 \$149.00



Precision Router Table Top

This 24" x 32" table top has a 1"-thick MDF core that absorbs vibration and offers mass to help create a stable router table.

ITEM# PRS1025 \$179.00



Precision Router Table Fence

This anodized-aluminum fence features a table saw-style T-Square adjustment system that ensures the fence will always stay parallel to the miter-gauge slot.

ITEM# PRS1015 \$199.00

Routing Accessories

Precision Router Table Stop

ITEM# PRS7850 \$24.99



The included Precision Lens Cursor gives you a clear and accurate view of the fence's tape.

Multi-Purpose Router Table Switch

ITEM# PRS3100 \$34.99



This switch makes a perfect companion to our Precision Router Table and Precision Benchtop Router Table.

Level-Loc Reducing Rings 5-Piece Set

ITEM# PRS3050 \$24.99



This five-piece set of Level-Loc Reducing Rings is the Precision Router Table Insert Plate, allowing you to customize the size of the opening around the bit.

Precision Router Table Setup Bars

ITEM# PRS3400 \$44.99



This set includes seven setup bars stored in a portable protective case. Sizes: 1/8" (3mm), 3/16" (4mm), 1/4" (6mm), 5/16" (8mm), 3/8" (10mm), 7/16" (11mm), 1/2" (12mm).

Predrilled Router Table Insert Plates

ITEM# PRS3034 \$59.99

ITEM# PRS3036 \$59.99



Make it easier than ever to mount your Triton, Bosch, or Porter-Cable router with a predrilled insert plate.

Heavy-Duty Casters

#PRS3090 \$59.99



Precision Router Table Insert Plate Levelers

#PRS3040 \$19.99



Kreg Tools

Precision Routing Systems

True-FLEX™ Featherboard



ITEM# PRS3010
\$19.99

True-FLEX™ Featherboard
Single Featherboard. Comes with Wedge-Lock hardware that works in T-slots or miter slots on table saws, router tables, and band saws.



ITEM# PRS3020
\$36.99

True-FLEX™ Featherboard Twin Pack
Comes with an extended version of the Wedge-Lock hardware, perfect for stacking. When used together, they provide additional support for tall workpieces, resulting in higher-quality cuts.

Precision Router Table Insert Plate



\$59.99

PRS3034 - Insert Plate for Triton TRA001 & MOF001 (also fits Porter-Cable 7500 series with slight modifications)

\$59.99

PRS3036 - Insert Plate for Porter-Cable 690/890 series & Bosch 1617

\$59.99

PRS3038 - Insert Plate, Non-Drilled

FEATURES

A LEVEL-LOC REDUCING RINGS

Change the size of the opening around your bit easily using these rings that simply twist into place and lock-in level and flush with the plate surface every time. Includes three rings: 1" (25mm), 1 3/8" (30mm) (for use with universal-style guide bushings), and 2 5/8" (67mm).

B WORKS WITH ANY ROUTER

This 9 1/4" (235mm) x 11 3/4" (298mm) x 3/8" (10mm) thick plate is designed to easily accept any router, and is built tough to resist sagging, with even the largest, heaviest routers.

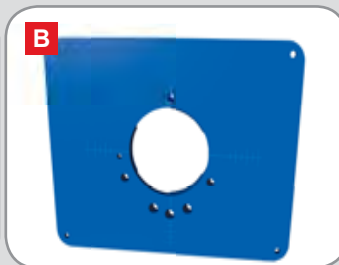

C ENGRAVED ROUTER ALIGNMENT MARKS

The undrilled Insert Plate (PRS3038) comes without pre-drilled holes, unlike so-called "universal" plates. Instead, it has laser-engraved alignment marks on the underside that make it extremely easy to center and mount your router.

D REMOVABLE BRASS STARTING PIN

This removable brass starting pin gives you the safety and control you need while routing freehand without a fence to guide the workpiece past the bit by providing a surface to rest your workpiece against before you pivot the workpiece against the bit.

Level-Loc Reducing Rings, 5-Piece Set

ITEM# PRS3050 **\$24.99**



The set includes rings with 3/4" (19mm), 1 3/8" (35mm), 1 5/8" (41mm), and 2 1/8" (54mm) openings, plus one "blank" ring that you can use to create your own custom-sized or zero-clearance ring.

The set comes with a molded storage tray that has slots to hold all five Level-Loc Reducing Rings, plus slots to hold the three rings that come with the Precision Router Table Insert Plate or Precision Router Table Lift. Each slot is marked with the opening size, making it easy to keep the rings organized.

Kreg Tools Precision Routing Systems

Precision Beaded Face-Frame System System

ITEM# PRS1200 \$379.00

System Includes:

The system comes complete with a Kreg 1/4" (6mm) x 1 1/2" (38mm) notching bit, Kreg 1/4" standard beading bit, Kreg 1/4" precision setup bar, and everything else you need to get started. Additional accessories, including unique beading bits and notching bits, are available for a wide variety of projects.



How It Works:



1) Use the control arm and smooth sliding base to plunge the stiles into the special notching bit.



2) Use the Precision Router Stop to ensure perfectly placed notches on the rails.



3) Switch to your standard routing fence and included beading bit to apply a decorative bead.



4) Use Kreg Joinery™ to secure the rails to the notched stiles. Glue is optional.



5) Done Now it's time to sit back and enjoy the beauty custom-made beaded face frames bring to your home.

FEATURES

A SLIDING BASE

The sliding base of the Precision Beaded Face-Frame System features 20 internal stainless steel ball bearings that guarantee smooth operation over the long haul.

B CONTROL ARM

The handle can be connected to the Precision Beaded Face-Frame System with or without the Control Arm. The arm provides improved control, smooth operation, and reduces the force necessary to plunge the workpiece into the bit.

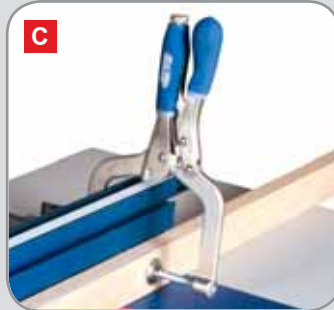
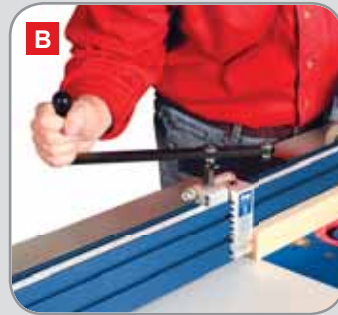
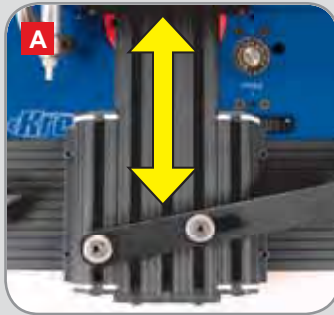

C INTEGRATED CLAMP

This heavy-duty clamp holds your workpieces firmly in place. Features a quick-release handle and adjustability for stock thickness.



D ROUTER TABLE STOP

The included Precision Router Table Stop lets you repeat cuts at the exact same measurement again and again. It features a Precision Lens Cursor for magnified accuracy and can be conveniently flipped out of the way when not in use.

OPTIONAL PROFILES

Searching for a more unique look? We have all the profiles you need to get the job done right. These special bits are designed for use with the Precision Beaded Face-Frame System.

Each bit features high quality 1/2" shank construction along with high-grade carbide tips for extreme durability. Above are our three beading bits and four standard notching bits. Contact customer service at 1-800-447-8638 or visit www.kregtool.com for more information.

Beading Bits

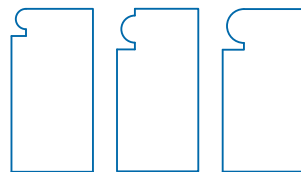

PRS4250 1/4" (6mm) Bit \$34.99	PRS4255 3/8" (8mm) Bit \$34.99	PRS4260 1/2" (10mm) Bit \$34.99
--	--	---

Notching Bits

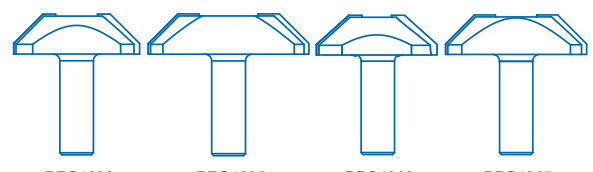

PRS4200 1/4" x 1 1/2" (6mm x 38mm) \$54.99	PRS4205 1/4" x 2" Bit (6mm x 50mm) \$59.99	PRS4210 3/8" x 1 1/2" (10mm x 38mm) \$54.99	PRS4215 3/8" x 2" (10mm x 50mm) \$59.99
---	---	--	--

LRH Designs

Carbide Tipped Raised Panel Shaper Cutters for 3/4" Stock

For Arch, Cathedral and Eyebrow type doors, a ball bearing guide is required. By raising or lowering the shaper spindle you can increase or decrease the thickness of the tongue. All panel cutters have 15° shear face.

Any Cutter, Any Bore, Any Diameter
\$449.00

For 3/4" Stock

Non-Stock Cutters Must Be Custom Made
Allow 10-12 Working Days.
Can Be Made FaceUp or FaceDown

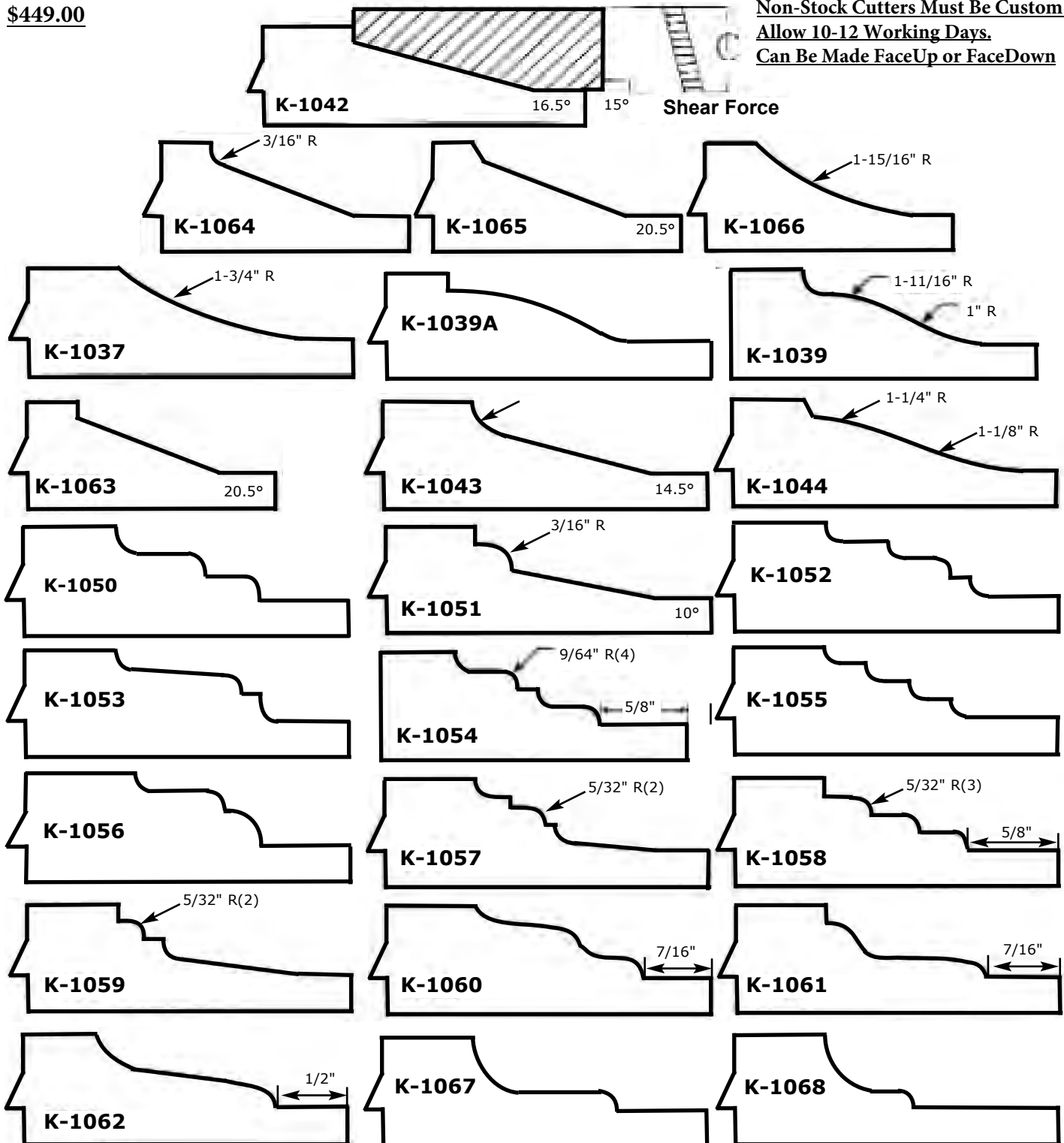

LRH Designs

Any Cutter, Any Bore, Any Diameter **\$449.00**

Carbide Tipped Raised Panel Shaper Cutters for 3/4" Stock

For Arch, Cathedral and Eyebrow type doors, a ball bearing guide is required. By raising or lowering the shaper spindle you can increase or decrease the thickness of the tongue. All panel cutters have 15° shear face.

Non-Stock Cutters Must Be Custom Made
Allow 10-12 Working Days.
Can Be Made FaceUp or FaceDown

Any One of These 9 Parts is \$499.00

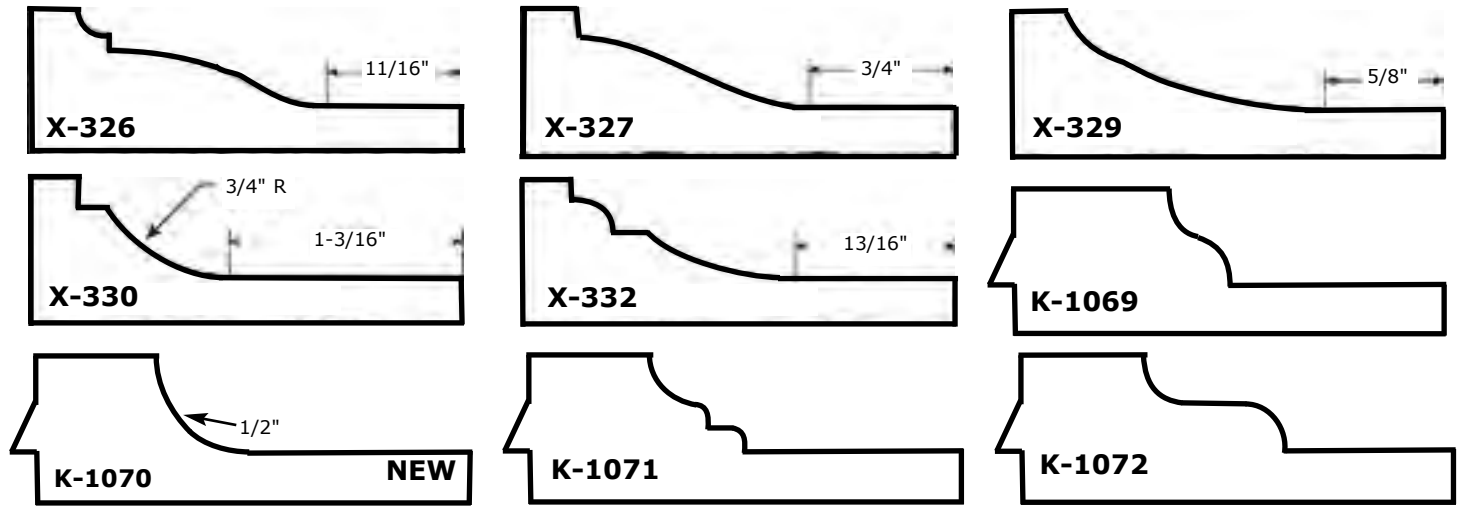

Full Double Raised Panels for 3/4" to 1 1/8" Material

Set "A" consists of using only one cutter running and run stock through shaper twice. Set "B" consists of having two cutters and spacer with only one pass through shaper. Set "BB" is the same as Set "B" and comes with a bearing. All come with standard steel spacer to cut 1/4" thick tongue. All panel cutters have 15° shear face.

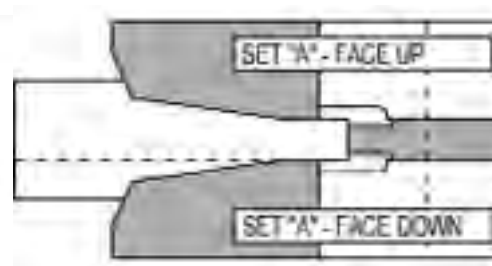
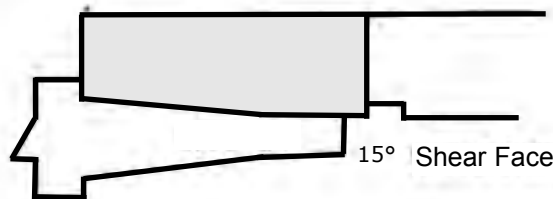
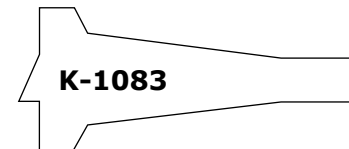
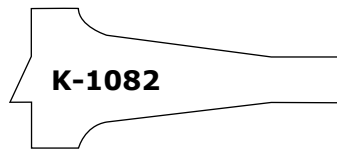
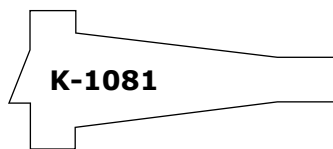

- 3/4" material shown.
- Both cutters with a spacer equals Set "B."
- Both cutters with a bearing in the middle equals Set "BB."

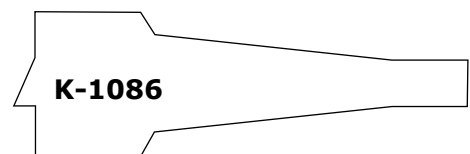
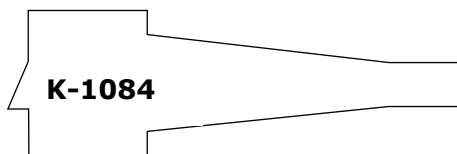

LRH Designs

Any Cutter, Any Bore, Any Diameter **\$449.00**

Carbide Tipped Raised Panel Shaper Cutters for 5/8" Stock

For Arch, Cathedral and Eyebrow type doors, a ball bearing guide is required. By raising or lowering the shaper spindle you can increase or decrease the thickness of the tongue. All panel cutters have 15° shear face.

Non-Stock Cutters Must Be Custom Made
Allow 10-12 Working Days.
Can Be Made FaceUp or FaceDown

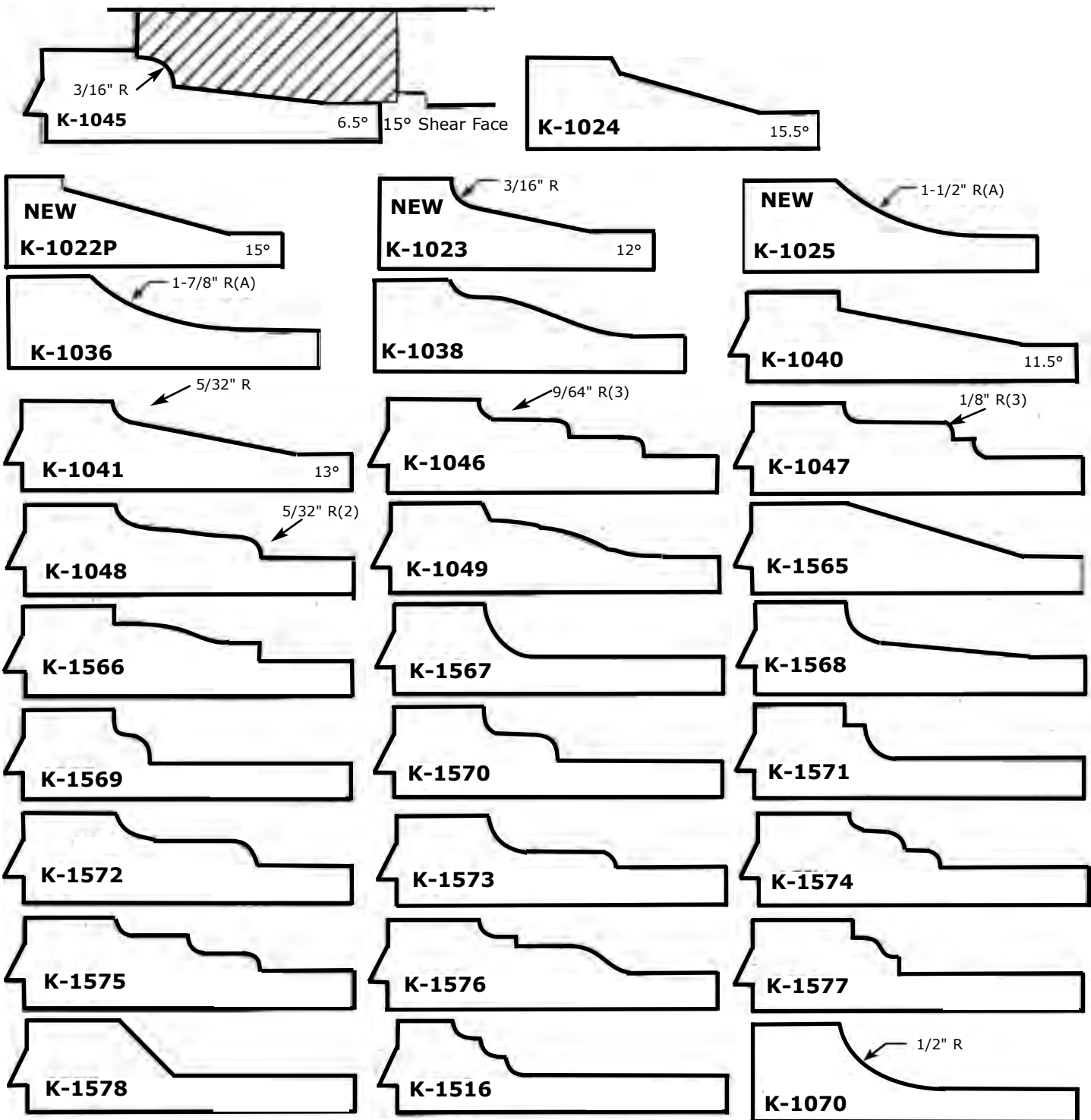

LRH

6 Piece" Component" Cope & Stick Cutter Sets

Sets are for 3/4" to 1-1/8" material, and wood samples are shown face up.
 The Outside Diameters for 1-1/4" bores are 3-5/8" and 3/4" bores are 3-1/8".

Note: Unless indicated as **Stock**, cutter will be manufactured, requiring 7-10 working days.

PR-752-FU
PR-752-FD

Last Set of LRH Cutters

FU Material Face Up **FD** Material Face Down

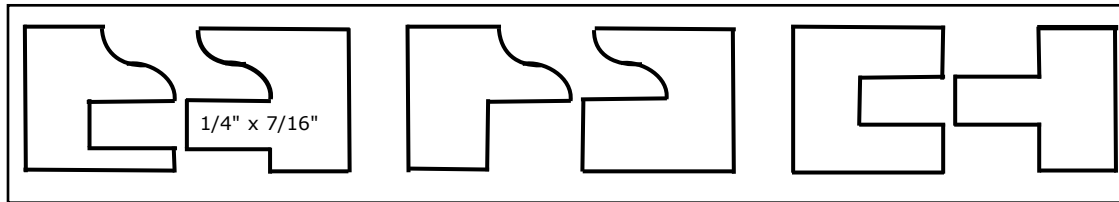

Stacking Instructions

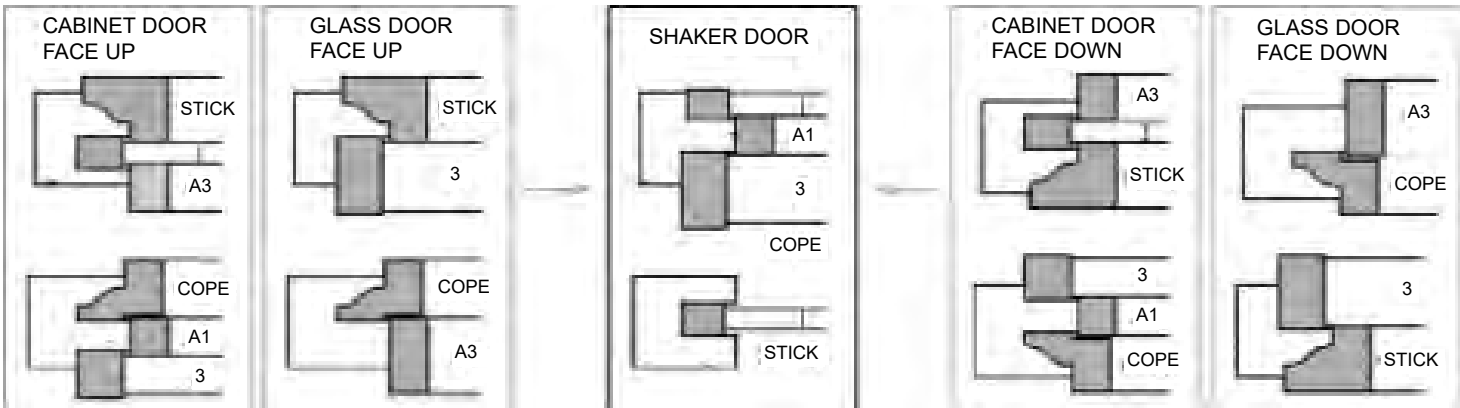

Double Detail Sets for 1" to 1-1/8" Material

Available Bearings: C-885 (3/4" Bore), C-891 (1-1/4" Bore)

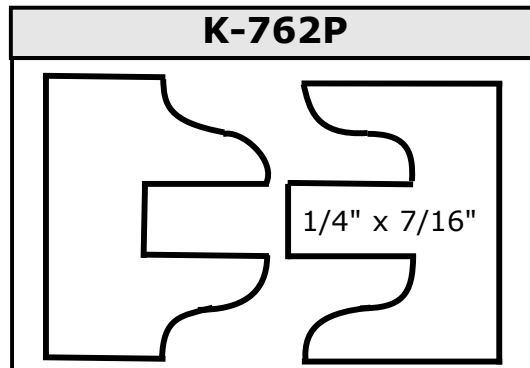

LRH Old Designs

Tongue & Groove Doors and Shaker Door

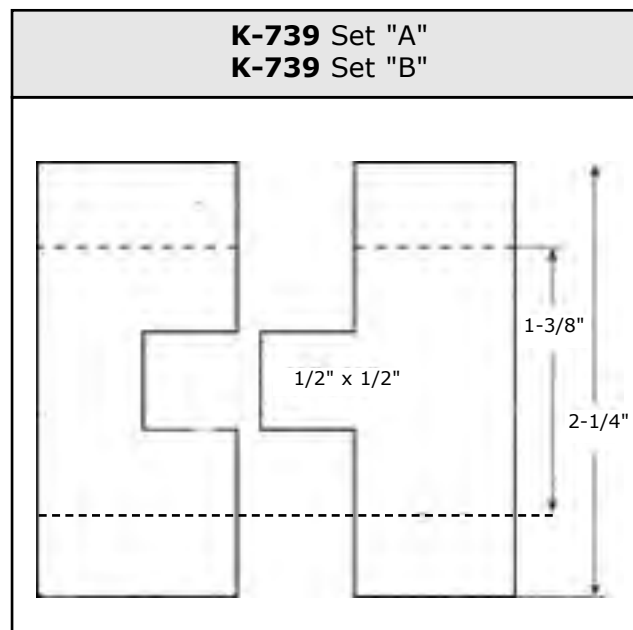
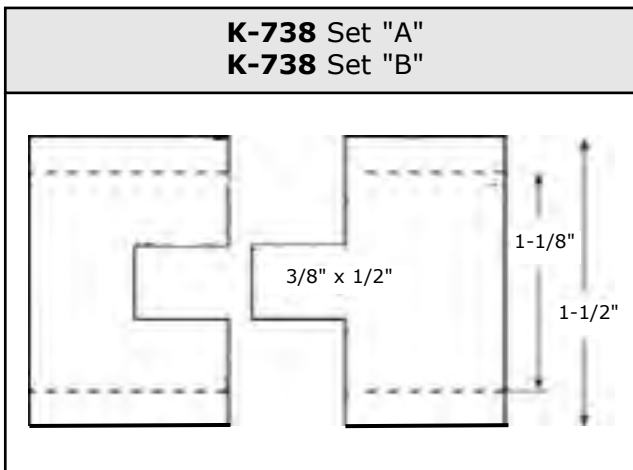
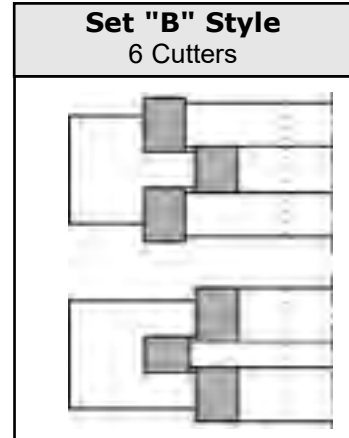
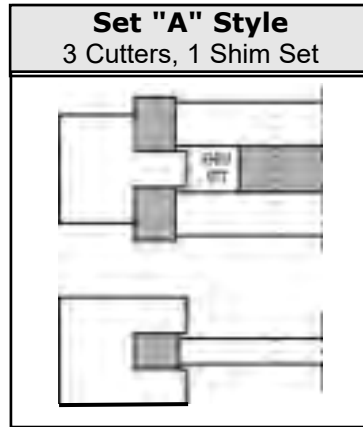
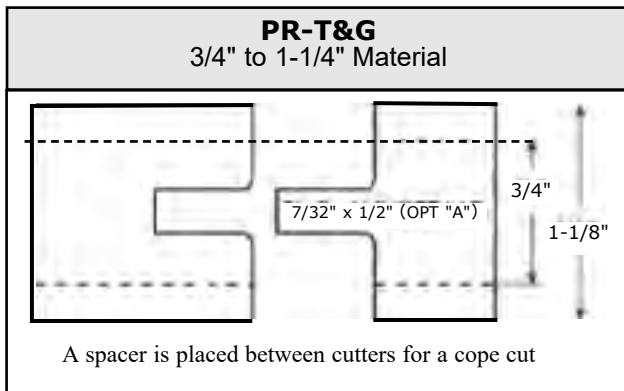
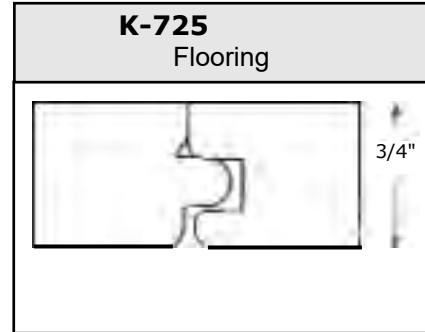
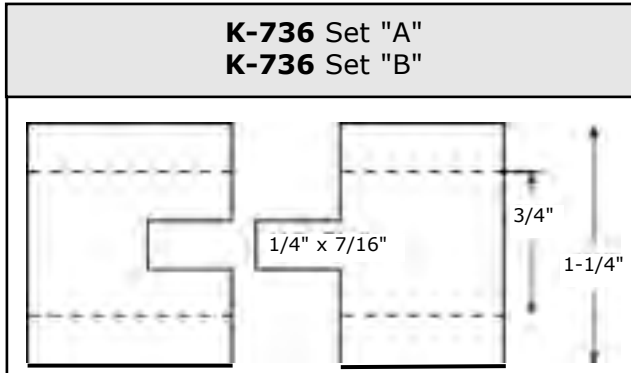

LRH Old Designs

1-3/4" Material (1/4" & 1/2" Wide Tongue and Groove)

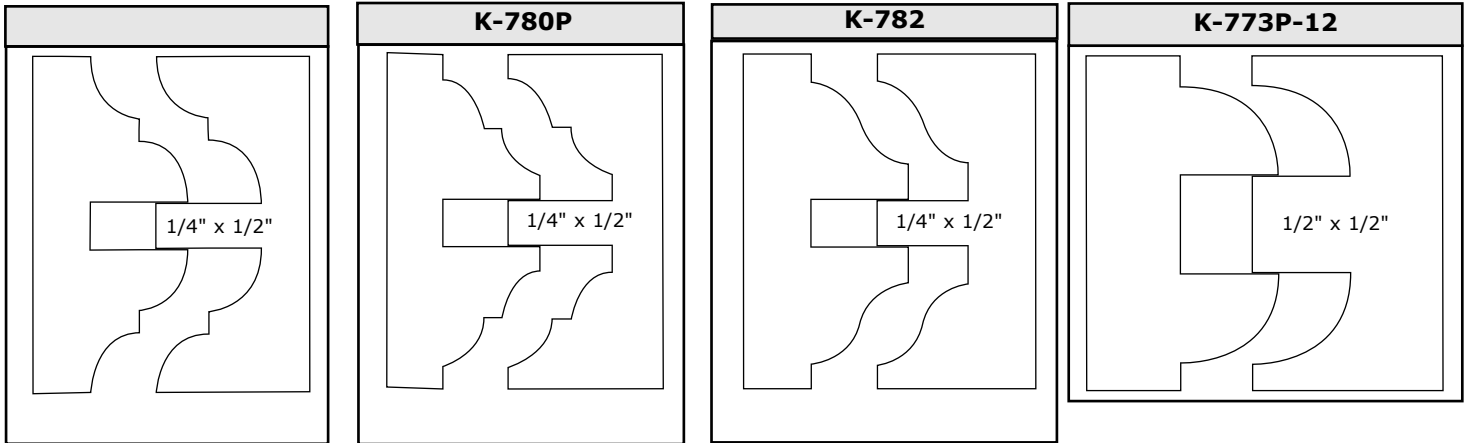

2" Material (1/2" Wide Tongue and Groove).

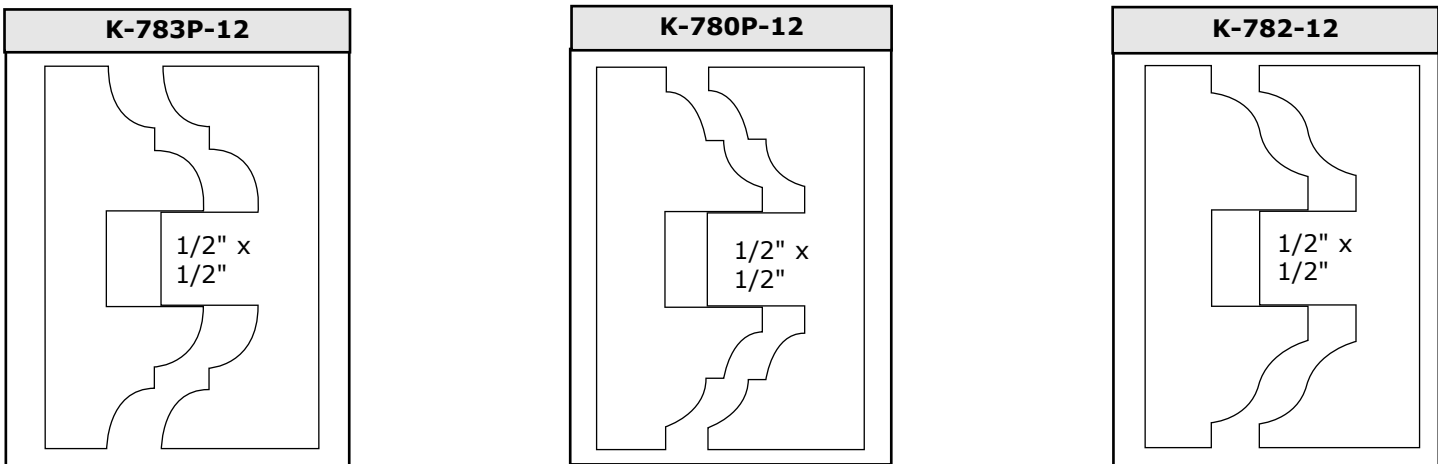

2-1/4"
Material
(5/8" Wide
Tongue and
Groove)

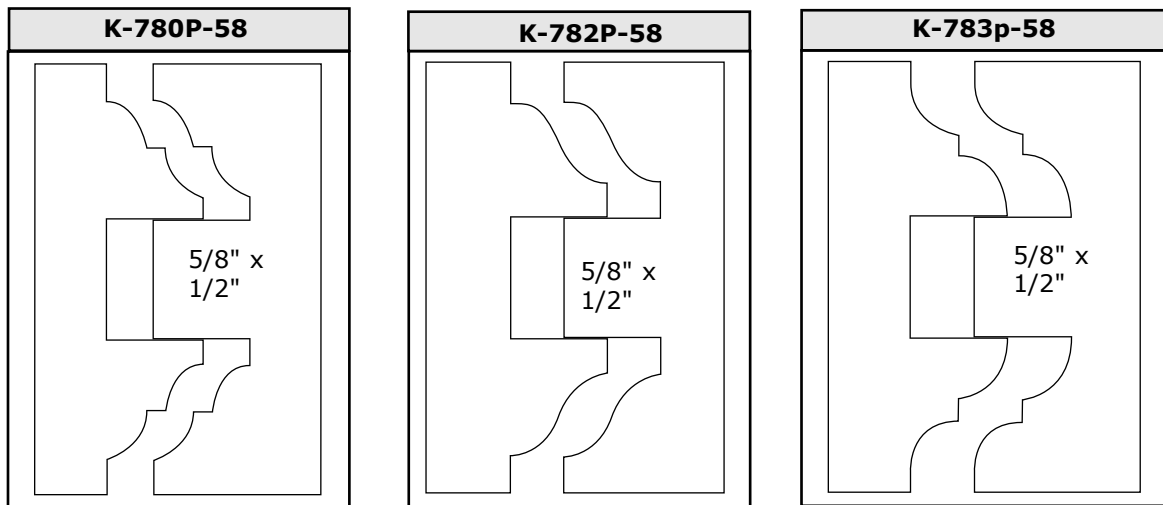

LRH Old Designs

1-3/8" to 1-3/4" Material (Glass Door)

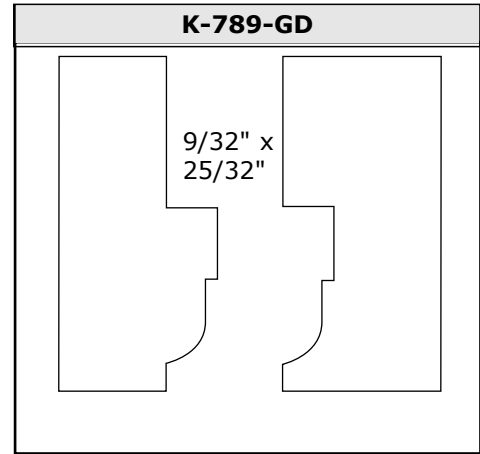
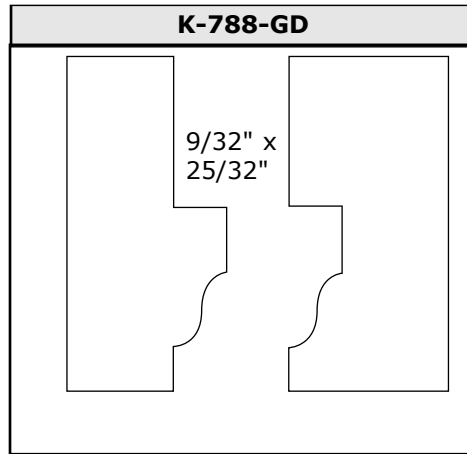
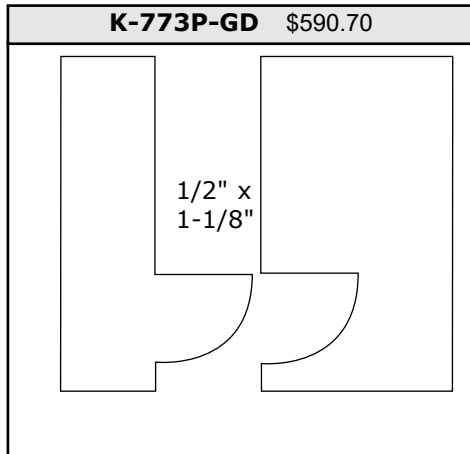

1-3/4" to 2-1/4" Material (Glass Door)

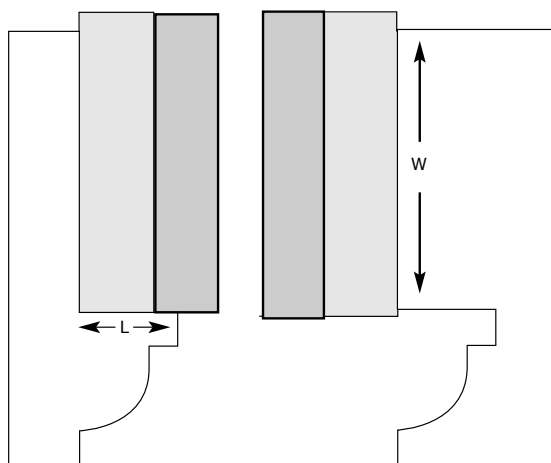
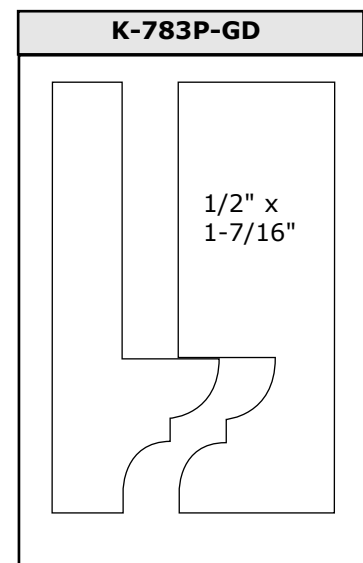
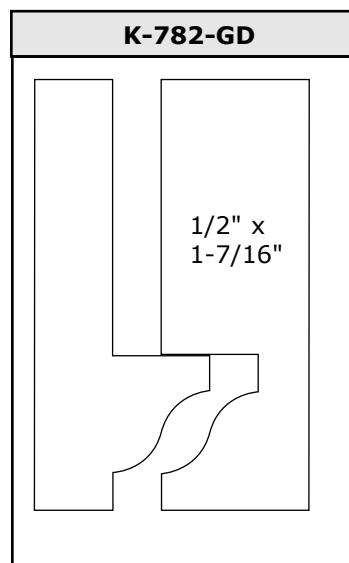
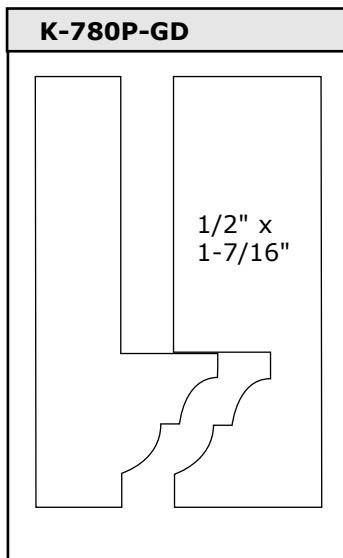

"King Cutter" Option "B" Sets (Glass Door)

Note: Unless indicated as **Stock**, cutter will be manufactured, requiring 7-10 working days.

PART		LENGTH	WIDTH
K-OPT-BP	Stock	1/2	1-7/16

- K-OPT. "B" Sets consist of two straight cutters, which are only sold as a set. There is no Match-A-Cut available.



LRH Old Designs

"King Cutter" Option "C" Sets (Tongue and Groove Cutters)



PART	LENGTH	WIDTH	OUTSIDE DIAMETERS	
			3/4 ARBOR	1 and 1/4 ARBOR
K-OPT-C-3/8	1/2	3/8	3-1/4	3-3/4
K-OPT-C-3/4	1/2	3/4	3-1/4	3-3/4

- K-OPT. "C" sets are two straight cutters and only sold as a set.

How to Set Up "Component" Door Lip Cutters

Shims are placed between the top and bottom cutters to acquire desired cut for various material sizes.

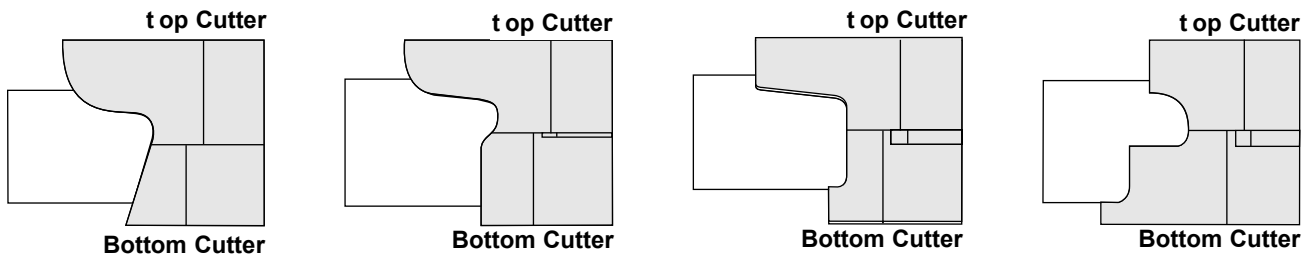

- All Top and Bottom Detail Door Lip Cutters are compatible with each other.
- Refer to the this page for examples of how to set up "Component" Door Lip Cutters.
- Match-A-Cut is available for Top Detail Door Lip Cutters but not for Bottom Detail Door Lip Cutters.

"Component" Bottom Door Lip Cutters

Each bottom cutter includes a few shims for adjustability. To achieve a greater adjustability, see the Accessories Section of the catalog for shim sets. All Bottom Door Lip Cutters will match with "Component" Top Door Lip Cutters in the previous section.



C-1-CP	C-3-S	C-3-SeP	C-4
C-1-CeP	C-1	C-3P	C-2

LRH Old Designs

All cope and sticks have a 1-3/4" outside diameter and a 22mm inside diameter.

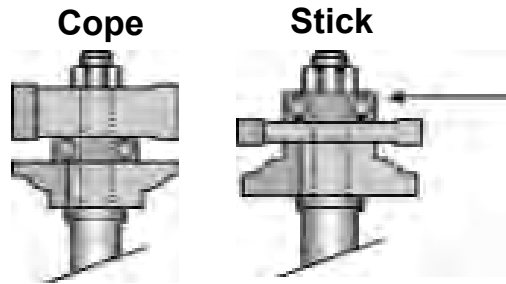

The bearing can be replaced with an H-A3 if a cutter is needed.

Cabinet Door Sets

PART	
H-48-S	H-48-C
H-49-S	H-49-C
H-750-S	H-750-C
H-752-S	H-752-C

Each cope & stick set will produce the three following wood samples: cabinet door, glass door, and shaker door.

STICK	COPE	EXAMPLE
H-48-S	H-48-C 1/4" x 7/16"	
H-49-S	H-49-C 1/4" x 7/16"	
H-750-S	H-750-C 1/4" x 7/16"	
H-752-S	H-752-C 1/4" x 7/16"	

LRH Old Designs

MDF Raised Panel Door System for Ritter & Other Panel Systems

PART	DESCRIPTION
R-1475-Set A	(2) R-1475-1, (1) R-1475-2 and (1) R-1475-3
R-1475-Set B	(1) R-1475-4 and (1) R-1475-5
R-1475-Set AB	(2) R-1475-1, (1) R-1475-2, (1) R-1475-3 (1) R-1475-4 and (1) R-1475-5

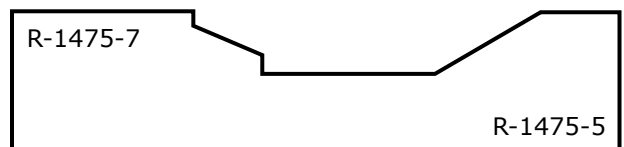
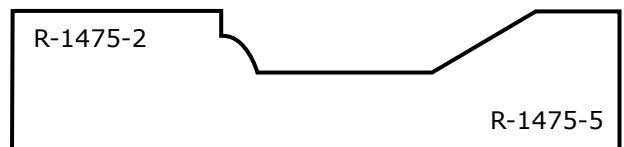
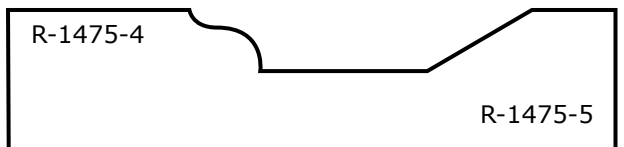
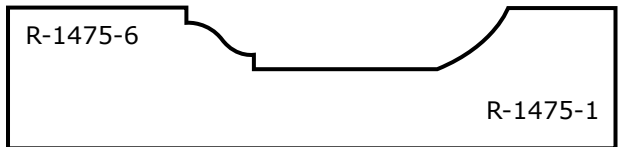
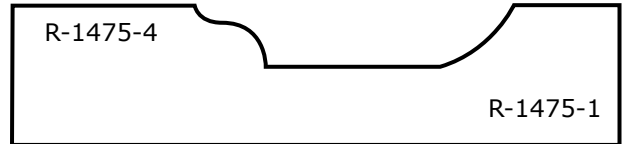
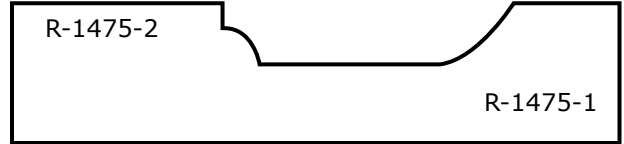
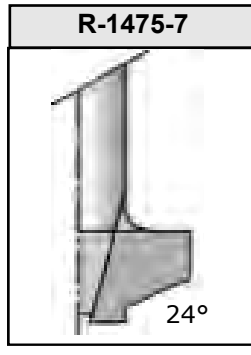
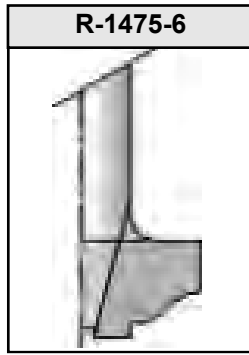
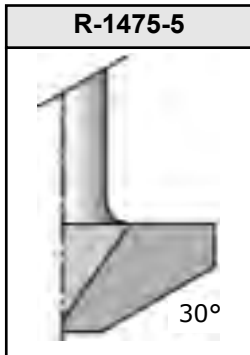
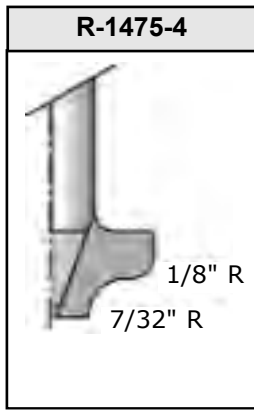
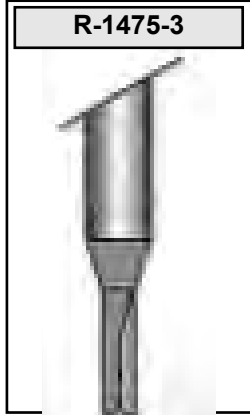

PART	OUTSIDE DIAMETERS
H-757	2-1/16



When properly positioned, these router bits will cut "A" and "B" matching joints without changing the vertical adjustment of the fence.

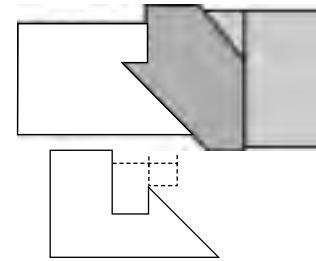
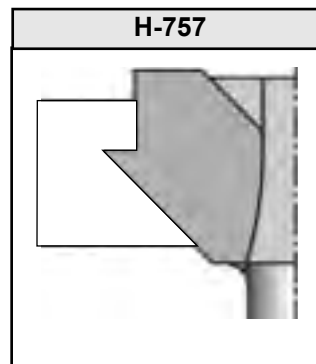

Both "A" and "B" are run flat on the router table. Part "B" is run again on the table saw to cut the groove.

Hand Rails

PART	INSIDE DIAMETERS	OUTSIDE DIAMETERS
H-1884A	3/4	2

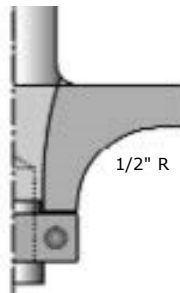

LRH Old Designs King Cutters

Carbide-Tipped Detail "Shaper" Cutter for 3/4"

Standard 1pc. cutter heads. Standard Bore is 3/4" or 1-1/4".

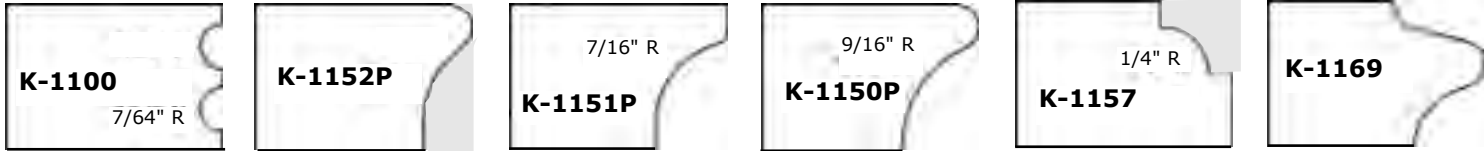
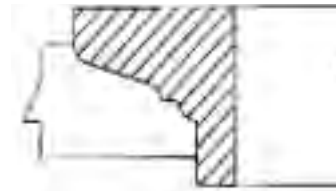

Carbide-Tipped Detail "Shaper" Cutter for

3/4" Standard 1pc. cutter heads. Standard Bore is 3/4", or 1-1/4".

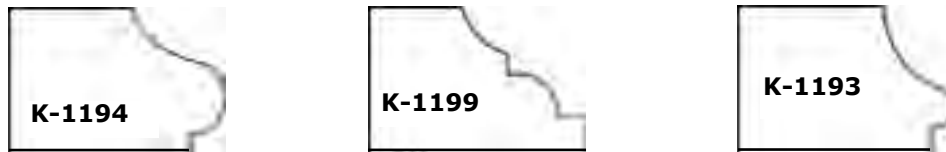
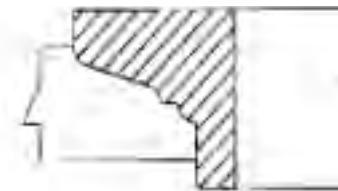

V-Panel Set

PART	INSIDE DIAMETERS	OUTSIDE DIAMETERS
H-729-S	22mm	1-3/4
H-729-C	22mm	2-1/4

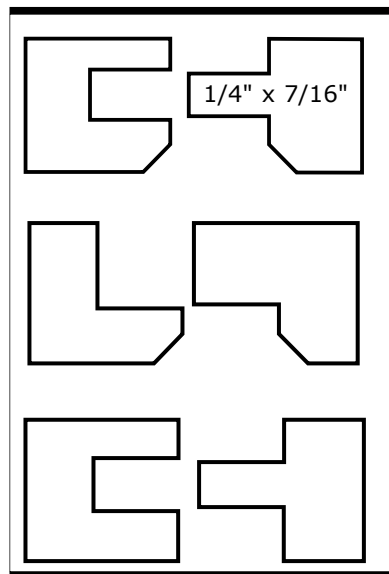
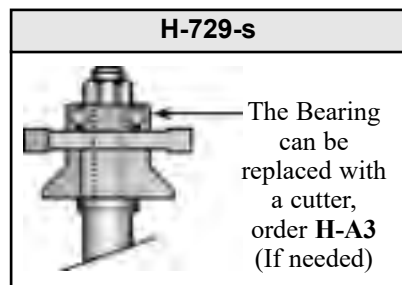
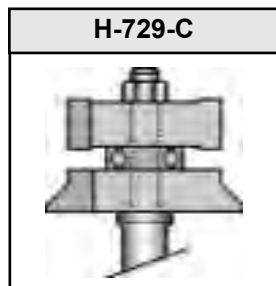

Window Sash Set

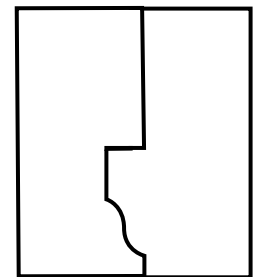
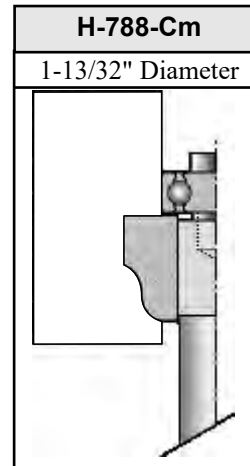

Edge Details

PART#	INSIDE DIAMETERS	OUTSIDE DIAMETERS
H-2012	1/2	1-5/8

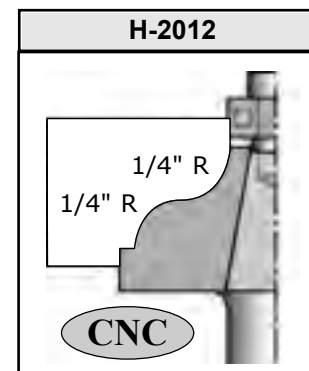

LRH Old Designs

"CO-ST" Cutters- Male and Female Stile & Rails Sets for Wood

set #1C	1C	
<ul style="list-style-type: none"> • 2-5/8" Cutting Diameter • 2 Wing • 3/4" Bore Only 		
set #4C	4C	
<ul style="list-style-type: none"> • 2-5/8" Cutting Diameter • 2 Wing • 3/4" Bore Only 		

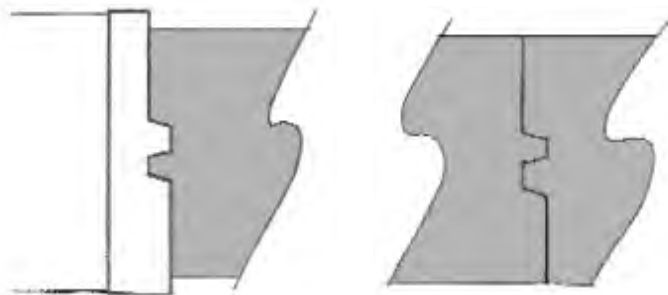

"CO-ST" Cutters
Glue Joint Cutter
(Flip Over Material for Mate)

8C
• 2-5/8" O.D.

"CO-ST" Cutters
Reversible Profiles (Flip Over Material for Mate)

9C
• 3-1/8" O.D.

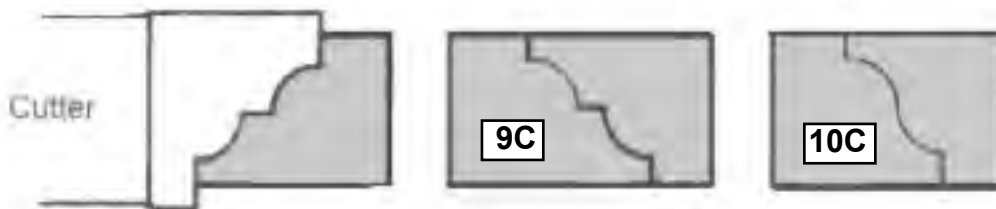

10C
• 2-7/8" O.D.

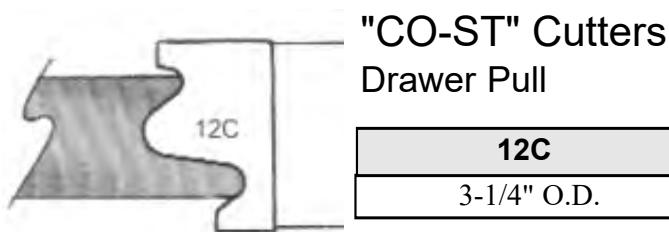

"CO-ST" Cutters
Drawer Pull

12C
3-1/4" O.D.

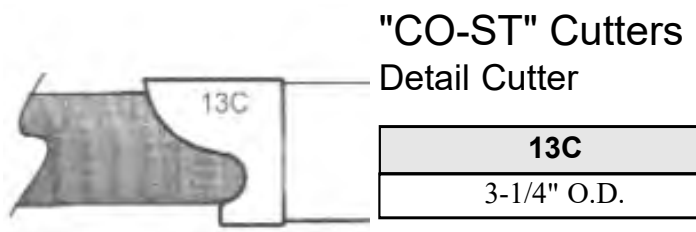

"CO-ST" Cutters
Detail Cutter

13C
3-1/4" O.D.

LRH Old Designs

"CO-ST" Cutters

Horizontal & Vertical Raised Panel



19C

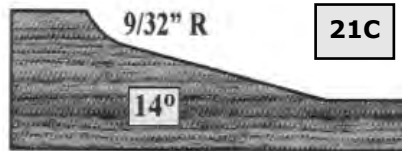

21C

19C
• 4-5/8" O.D.

21C
• 4-5/8" O.D.

"CO-ST" Cutters
Single/Partial Double
Panel Cutters



23C

Spacer Included

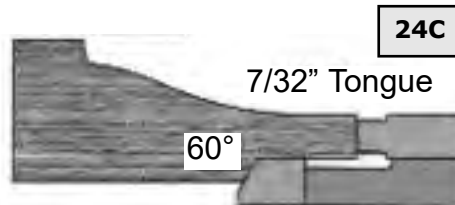

24C

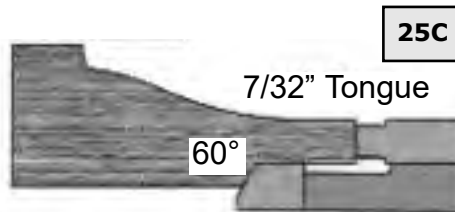

25C

23C
• 4-5/8" O.D.

24C
• 2-5/8" O.D.

25C
• 2-7/8" O.D.

"CO-ST" Cutters
Stair Tread Nose

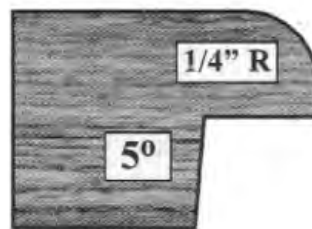

29C

- Rabbet Edge
- 2-7/8" O.D.

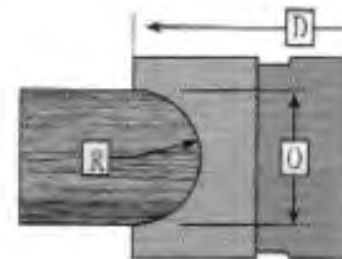

34C

- 3" O.D.

"CO-ST" Cutters Casing



40C

- 4-3/4" O.D.

"CO-ST" Cutters Moulding

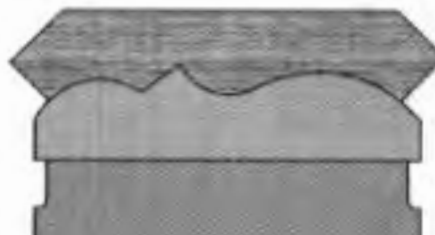

39C

- 2-3/4" O.D.

"CO-ST" Cutters Brick Mold

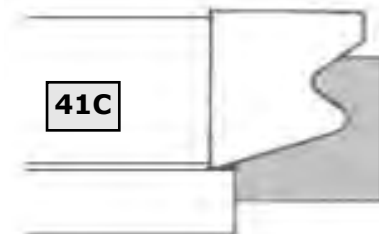

41C

41C

- 3-3/8" O.D.

LRH Old Designs

"CO-ST" Cutters-Straight Cutters (2-5/8" O.D., 2-Wing and 3/4" Bore)

Straight, Jointing, Groove & Rabbet Cutters (Matched Diameters: 2-5/8")

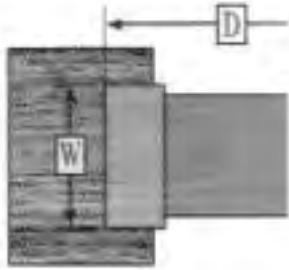

PART	WIDTH OF CUT
44C	1/4
45C	3/8

PART	WIDTH OF CUT
49C	1
50C	1-1/4
51C	1-1/2

QUARTER ROUND CONCAVE

PART	RADIUS	O.D.
58C	1/4	2-1/2
60C	1/2	3
61C	3/4	3-1/2
62C	1	4

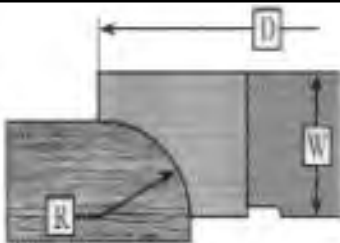

QUARTER ROUND CONCAVE

PART	RADIUS	O.D.
53C	1/4	2-1/2
57C	1	4

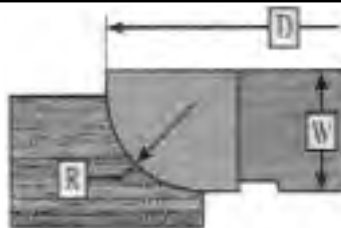

HALF-ROUND CONCAVE

PART	WIDTH	RADIUS	O.D.
63C	1/4	1/8	2-1/4
64C	3/8	3/16	2-3/8
65C	1/2	1/4	2-1/2
66C	3/4	3/8	2-3/4
67C	1	1/2	3

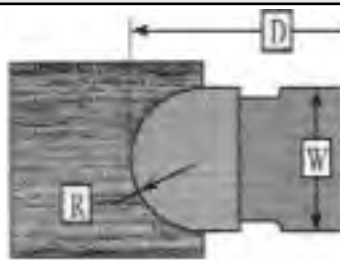

HALF-ROUND CONCAVE

PART	WIDTH	RADIUS	O.D.
68C	1/4	1/8	2-1/2
69C	3/8	3/16	2-3/8

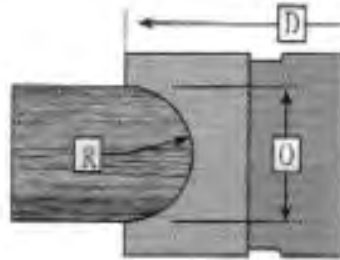

"CO-ST" Cutter Matching Shaper Cutter (2-Wing, 3/4" Bore)

74C
• 2-5/8" O.D.

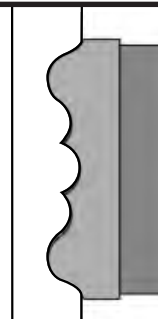

"CO-ST" Cutters - Flute Cutters for use on Table Saws (4-Wing, 5/8" Bore)

Tilted 30° for continuous wood pull. Hand sand to break sharp edge.



37C-3/8	38C	37C
\$179.00	\$149.00	\$199.00

3/4" Wide 5/8" Wide

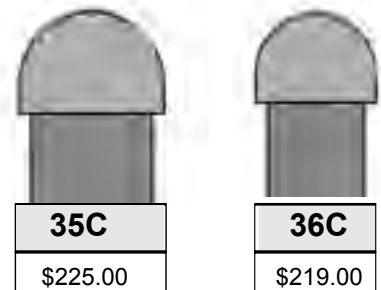

"CO-ST" Cutters Inlay Rosette Cutters (2-Wing, 1/2" Shank)

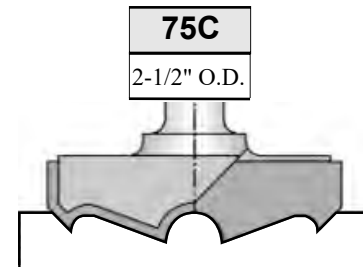
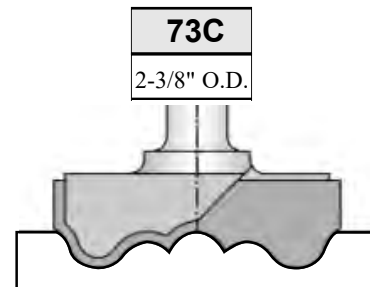

We Also Have The Following LRH Cutters In Stock. Please Call Us For Specifications and Special Prices.

30C	A-1-1*1/4	K-1044-1-1/4	C-1-3*4
32C	A15*5*3/4	K-1090A-F.D-3/4	C-1-1
43C	A-20-1	K-1090B	C-1-1*1/4
47C	A-20-1"	K-1111-1*1/4	C-1203-1
52C	A-2-1*1/4	K-1156-1	C-1203-1*1/4
	A-3069-1*1/4	K-1156-1*1/4	C-1203-3/4
IH-3080	A-3081A-1	K-1156-3/4	C-1205-1
1HM-735C	A-3081B-1	K-1172-1*1/4	C-1205-1*1/4
IH-1090	A3-1	K-1203-3/4	C-1205-3/4-FU
IH-1165	A-5-1*1/4	K-1408-1*1/4	C-1-3/4
IH-70-6	C-10-1*1/4	K-1410-3/4	C-13-3/4
IH-725	C-A10-1*1/4	K-1412-1	C-1618-1
IH-735-STICK		K-1415-1*1/4	C-1619-1*1/4
IH-736	PR-IH-1703-CIC	K-1418-1*1/4	C-1619-3/4FD
IH-C-Cutter	PR-5H-C-CUTTER	K-1420-1*1/4	C-1-E-1
IH-GD-428	PR-IH-1030	K-1421-3/4	C-1-E-1*1/4
IH-GD-48FD	PR-IH-1038	K-1423-3/4	C-1-E-3/4
IH-RP-58	PR-IH-1040	K-1432-1*1/4FU	C-21
	PR-IH-1049	K-1437-1	C-3P-1
K-OPT-B-1*1/4	PR-IH-1090A	K-1439-1*1/4	C-3P-1*1/4
	PR-IH-1619-CIC	K-1441-1*1/4	C-3P-3/4
Arbor 3/4*1/2 Nut	PR-IH-1702-C3S	K-144-3/4 Bore	
	PR-IH-1703-C3S	K-1449-3/4	
C-Spacer-1-1/4	PR-IH-1703-CES	K-1460-1 (OPPO SET)	
C-CUTTER-1-1/4	PR-IH-1703-CIC	K-1461-3/4	
	PR-IH-619C	K-1919-1	
SC-MM-SCREW	PR-IH-C-Cutter	K-2012-1	
		K-735 SET B-1	

We Still have Some of the Original LRH Insert Tool Holders.

**We Can Also Get Some of the Less Popular or Custom Inserts
for the LRH Insert Tool Holders**

**If You Do Not See What You Need, Please Give Us A Call for
More Information.**

Parts Number	Price	Parts Number	Price
KI-48-C-FD	\$ 34.77	KI-1038-FU	\$ 34.77
KI-48-S-FD	\$ 34.77	KI-1039-FU	\$ 34.77
KI-49-C-FD	\$ 34.77	KI-1040-FU	\$ 34.77
KI-49-S-FD	\$ 34.77	KI-1041-FU	\$ 34.77
KI-54-C-FD	\$ 34.77	KI-1042-FU	\$ 34.77
KI-54-S-FD	\$ 34.77	KI-1043-FU	\$ 34.77
KI-750-C-FD	\$ 34.77	KI-1044-FU	\$ 34.77
KI-750-S-FD	\$ 34.77	KI-1049-FU	\$ 34.77
KI-752-C-FD	\$ 34.77	KI-1090A	\$ 27.77
KI-752-S-FD	\$ 34.77	KI-1090B	\$ 27.77
KI-232-C-FD	\$ 40.46	KI-1215-C1C	\$ 35.77
KI-232-S-FD	\$ 40.46	KI-1215-C3S	\$ 35.77
KI-233-C-FD	\$ 40.46	KI-1702-C1C	\$ 35.77
KI-233-S-FD	\$ 40.46	KI-1702-C3S	\$ 35.77
KI-234-C-FD	\$ 40.46	KI-1703-C1C	\$ 35.77
KI-234-S-FD	\$ 40.46	KI-1703-C3S	\$ 35.77
KI-242-C-FD	\$ 40.46	KI-1619-C1C	\$ 36.66
KI-242-S-FD	\$ 40.46	KI-1619-C3S	\$ 36.66
KI-735-C	\$ 34.77	KI-1165	\$ 31.20
KI-735-S	\$ 34.77	KI-717-P	\$ 41.54
KI-736-C	\$ 41.54	KI-749	\$ 40.46
KI-736-S	\$ 41.54	KI-725-C	\$ 33.10
KI-1036-FU	\$ 34.77	KI-725-S	\$ 33.10
KI-1037-FU	\$ 34.77		

INSERT TOOLING

Universal Designated Cabinet Door Sets With 5/8" x 5.5 mm Tongue

Two Piece Set of Heads Below (without tips) \$754.25.

LRH style insert heads are still available.

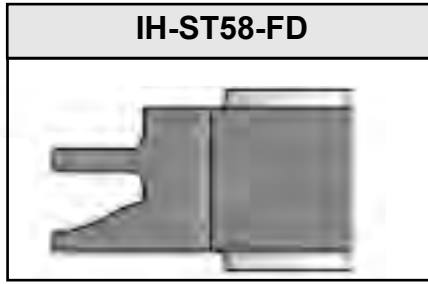
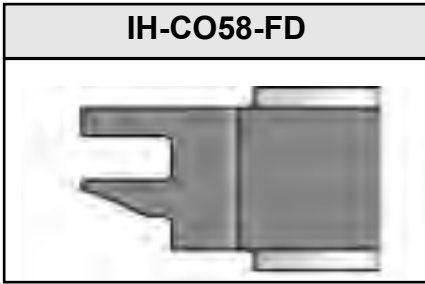

NOTE: Unless indicated as **Stock**, cutter will be manufactured, requiring 7-10 working days.

The **NEW** "Repeater Sets" are produced in a 1-1/4" bore only. The tip diameter on each set is 4-1/4" and all tips will cut 3/4" to 15/16" material. The Stick tips will only work with IH-ST58-FD heads and all Cope tips are only compatible with IH-CO58-FD heads.

*COMPLETE SETS BELOW
(Price Includes 2 Insert
Heads and 6 Insert Tips)
\$949.00*



Insert tips may be purchased individually for \$40.46 each.

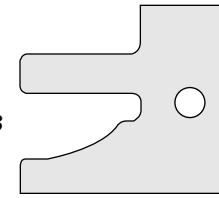
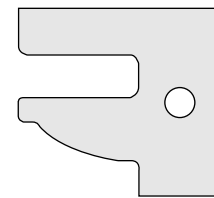
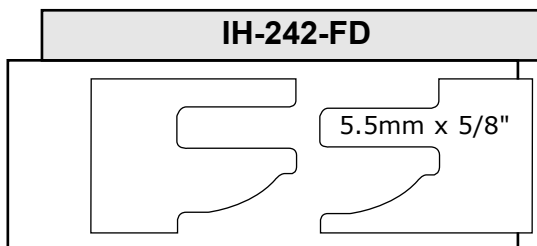
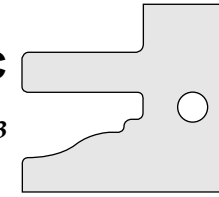
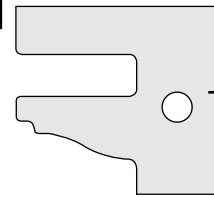
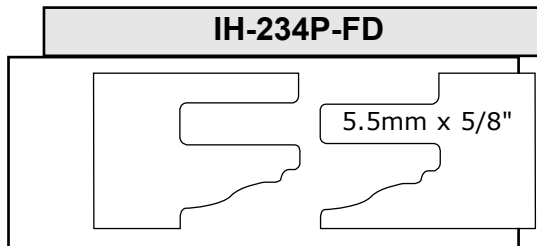
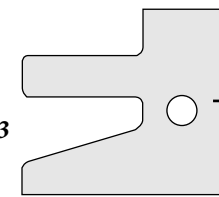
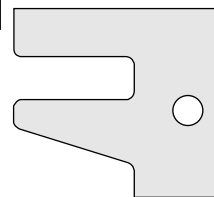
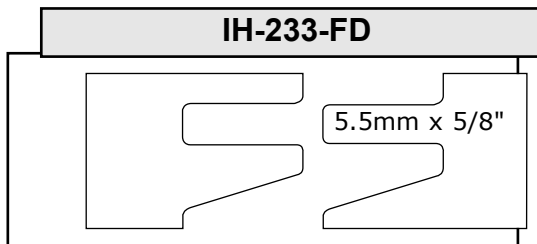
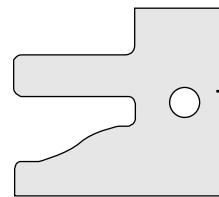
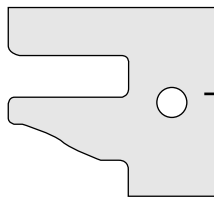
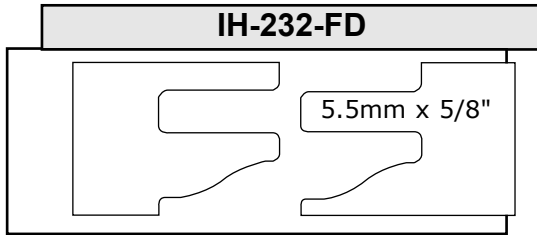

INSERT TOOLING

Universal Designated Cabinet Door Set

LRH style insert heads are still available.

NOTE: Unless indicated as **Stock**, cutter will be manufactured, requiring 7-10 working days.

The "Original Repeater Sets" are produced in a 1-1/4" bore only. The tip diameter on each set is 3-7/8", and all tips will cut 3/4" to 15/16" material. The Stick tips will only work with IH-STICK-FD heads and all Cope tips are only compatible with IH-COPE-FD heads. Will work on unique machines.

Complete Sets \$818.66. Set Includes 2 Insert Heads and Your Choice of 6 Insert Tips.

Two Piece Insert Head Set (without tips) \$642.86.

Insert Tips may be purchased individually for \$34.77 each.

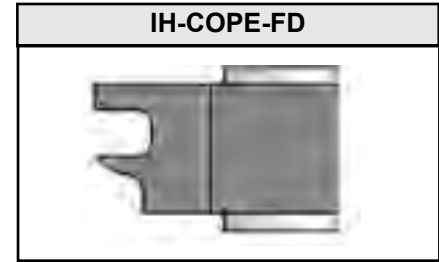
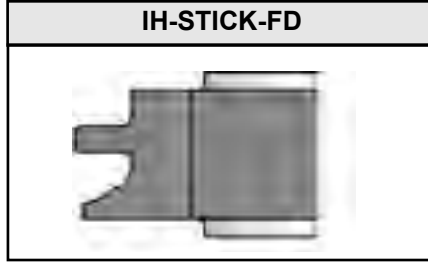

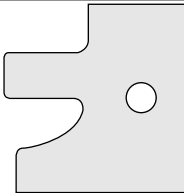
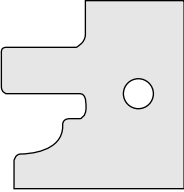
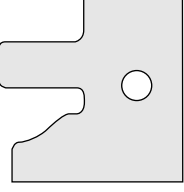
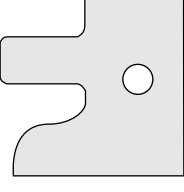
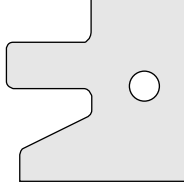
	STOCK KI-48-S \$104.31/set of 3
	STOCK KI-49-S \$104.31/set of 3
	STOCK KI-750-S \$104.31/set of 3
	STOCK KI-752-S \$104.31/set of 3
	STOCK KI-54-S \$104.31/set of 3

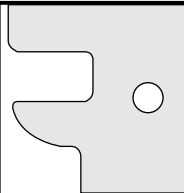
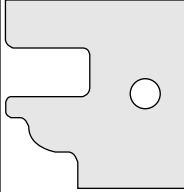
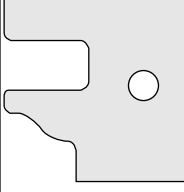
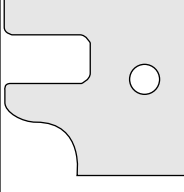
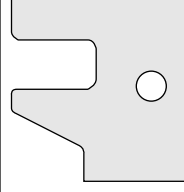
	STOCK KI-48-C \$104.31/set of 3
	STOCK KI-49-C \$104.31/set of 3
	STOCK KI-750-C \$104.31/set of 3
	STOCK KI-752-C \$104.31/set of 3
	STOCK KI-54-C \$104.31/set of 3

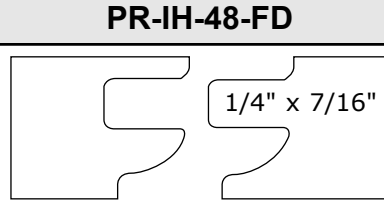
	1/4" x 7/16"
--	--------------

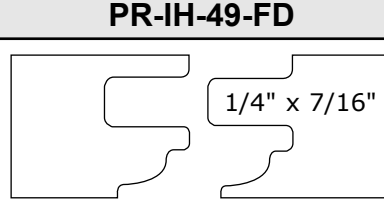
	1/4" x 7/16"
---	--------------

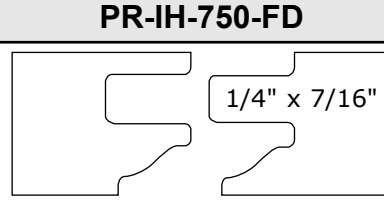
	1/4" x 7/16"
---	--------------

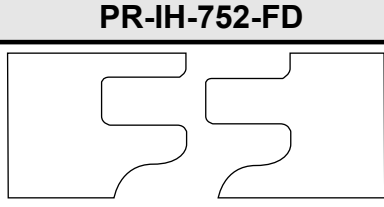
	
---	--

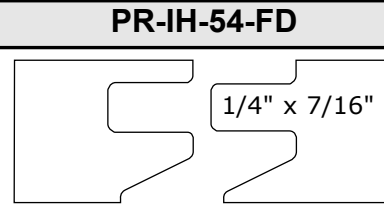
	1/4" x 7/16"
---	--------------

INSERT TOOLING

Universal Designated Raised Panel Cutters for 5/8" Material **Body Only for \$299.00**

The Universal Designated Raised Panel Cutter is made with three wings, a 1-1/4" bore, and a 10° sheared face. This tool is designed to run face-up and counterclockwise. The tip diameter is 6", and the body diameter is 6-1/2". These heads are recessed for bearing or IH-C Cutter.

The Universal Designated design of the IH-RP58 head allows the use of all five of the following profiles with one head. The tips produce a 1-5/8" deep profile.

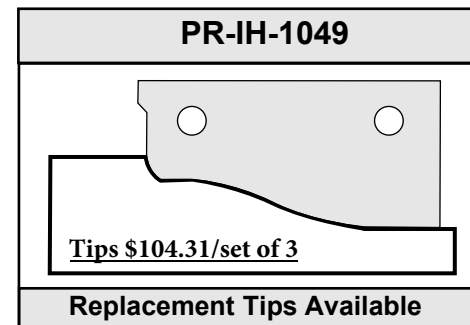
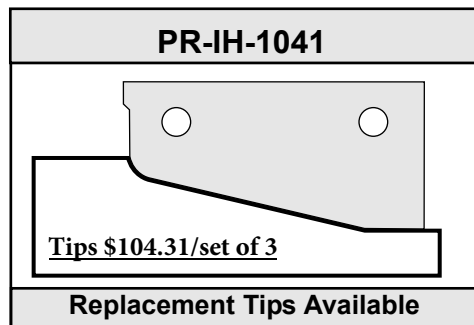
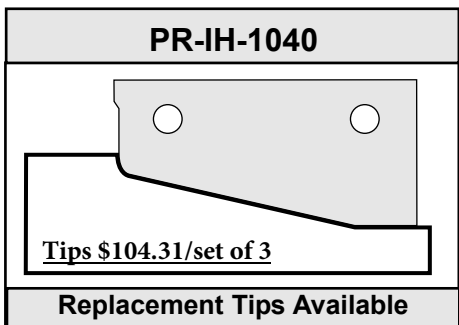
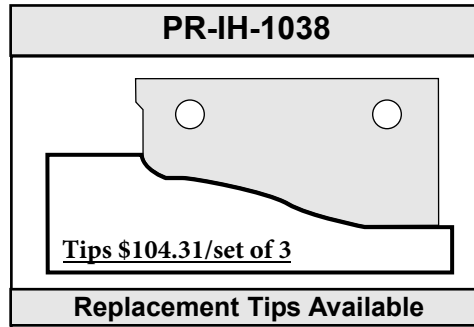
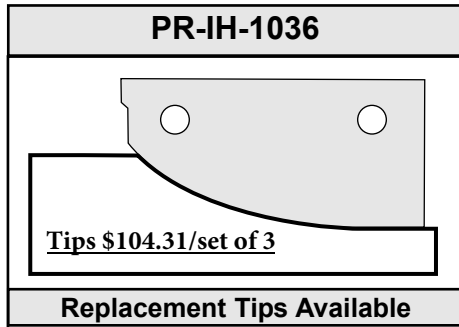

Partial Double Raised Panels for 5/8" Material

The Partial Double Raised Panel Head will accommodate both the KI-1090A and KI-1090B tips. The head is made with three wings and a 1-1/4" bore. It is designed to run face-up and counterclockwise. Tongue Trimmer Cutter available for these 2 cutters.

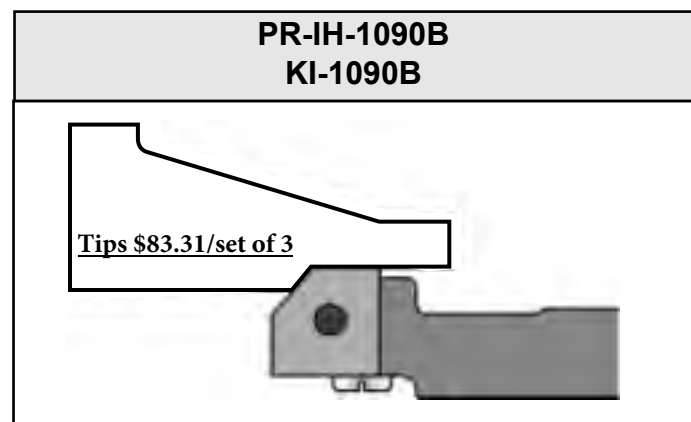
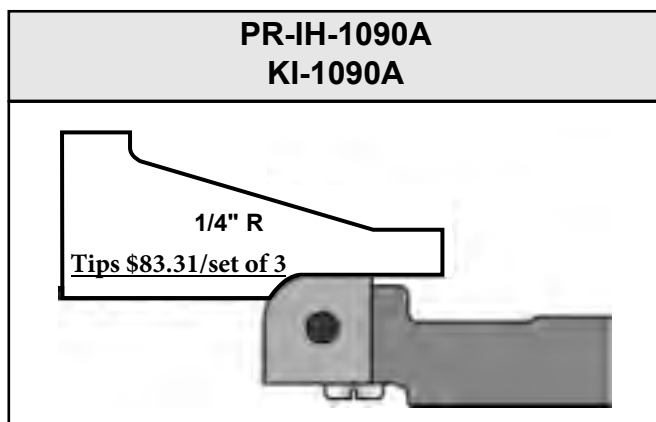

INSERT TOOLING

Door Edge Details

The following IH-DE2 Head will accommodate all of the following six profiles. It has three wings, a 1-1/4" bore, and a 4-1/4" diameter. It will cut material from 3/4" to 1-1/8". Any profile replacement insert: \$35.77 each.

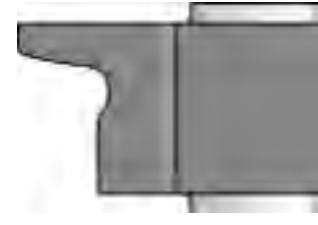
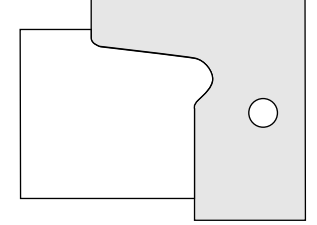
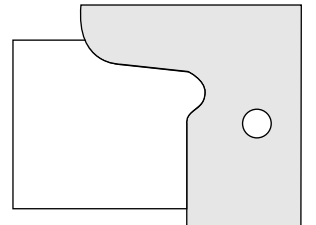
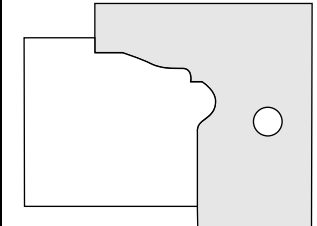
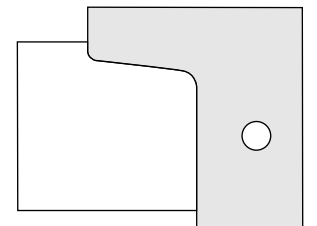
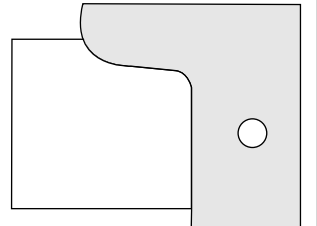
<p><i>IH-DE2</i> head only for \$299.00</p> <p>Replacement Tips are \$35.77/each</p>	<p>IH-DE2</p> 	<p>KI-1703-C1C</p> 	<p>KI-1215-C1C</p> 
	<p>KI-1702-C1C</p> 	<p>KI-1703-C3S</p> 	<p>KI-1215-C3S</p> 



The following IH-DE head will accommodate both the KI-1619-C3S and the KI-1619-C1C tips. It has three wings, a 1-1/4" bore, and a 4-1/2" diameter. It will cut from 3/4" to 1-1/8" material.

Head only for
\$299.00

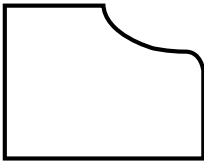
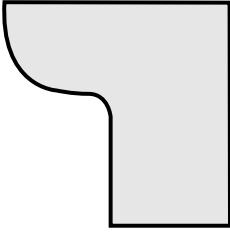
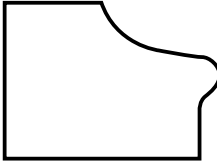
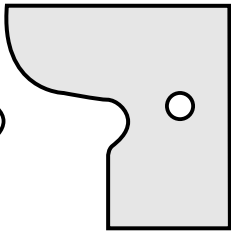

KI-1619-C3S	\$36.66	KI-1619	\$36.66
PR-IH-1619-C3S	\$350.00	PR-IH-1619-C1C	\$350.00
 		 	

IH-C-CUTTER	
HeAD	 <p>The IH-C-CUTTER is made with three wings, a 1-1/4" bore, and a 2-3/4" tip diameter. It runs with 2-1/32" shims to produce a 1/4" tongue. For a 5.5mm tongue, remove one shim.</p>
KI-C	
tIP	

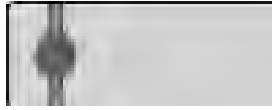
C-891	
	<p>The C-891 has a 1-1/4" bore and a 2-3/4" diameter. The bearing matches the inside diameter of the Raised Panel Set. Shims are included for adjustability.</p>

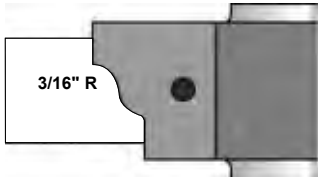
KI-178	
 <p>tIP 3/16" R</p>	
IH-178	
<p>Head (Price does not include inserts)</p> <p>The IH-178 has three wings, a 1-1/4" bore, and a 3-3/4" diameter.</p>	

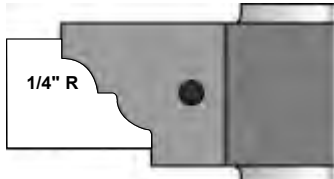
KI-182	
 <p>tIP 1/4" R</p>	
IH-182	
<p>Head (Price does not include inserts)</p> <p>The IH-182 has three wings, a 1-1/4" bore, and a 4-1/4" diameter.</p>	

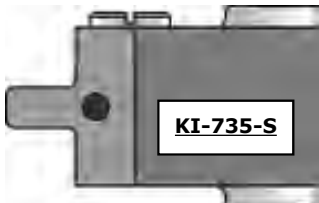
IH-735-S	
IHM-735-S	
 <p>KI-735-S</p>	

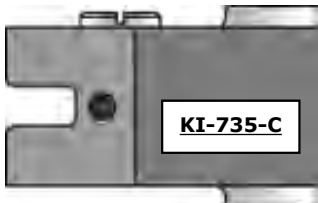
IH-735-C	
IHM-735-C	
 <p>KI-735-C</p>	

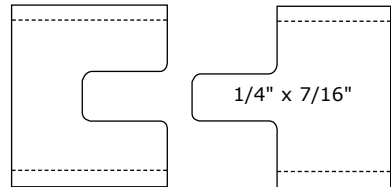
IH-735	
IHM-735	
 <p>1/4" x 7/16"</p>	

IH-736-S	
IHM-736-S	
 <p>KI-736-S</p> <p>IN STOCK</p>	

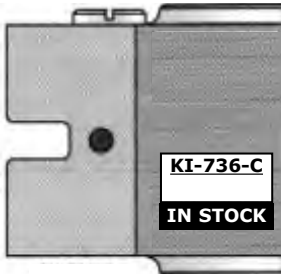
IH-736-C	
IHM-736-C	
 <p>KI-736-C</p> <p>IN STOCK</p>	

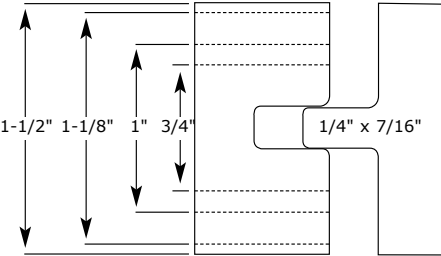
IH-736	
IHM-736	
 <p>1-1/2" 1-1/8" 1" 3/4" 1/4" x 7/16"</p>	

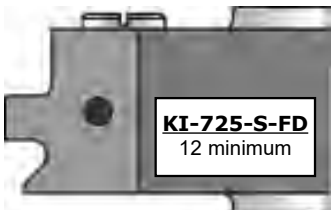
IH-725-S-FD	
IHM-725-S-FD	
 <p>KI-725-S-FD</p> <p>12 minimum</p>	

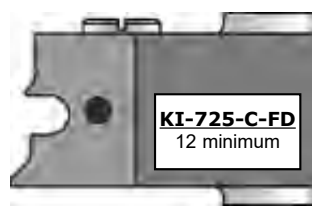
IH-725-C-FD	
IHM-725-C-FD	
 <p>KI-725-C-FD</p> <p>12 minimum</p>	

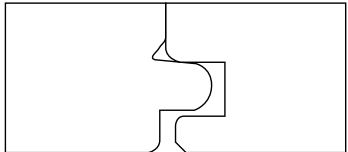
IHM-725	
IH-725	
 <p>NON-STOCK</p>	

The Magic Molder

The Magic Molder cutter heads are designed for use on standard radial-arm and table saws. For 7-1/2", 8", 9", 10" and 12", factory made, radial-arm and table saws with 5/8" and 1" arbors.

Each Magic Molder set contains the necessary spacer and a wrench for mounting detail plugs in the Magic Molder.

PART#	ITEM	BORE	PRICE
MM-2	Magic Molder Head #2	5/8"	\$149.00
MM-2-1	Magic Molder Head #2	1"	\$159.00
P-1 thru P-84	1 Set		\$139.00



*R=RADIUS
 *D=DIAMETER
 *PLEASE NOTE DIMENSIONS ON DRAWINGS.

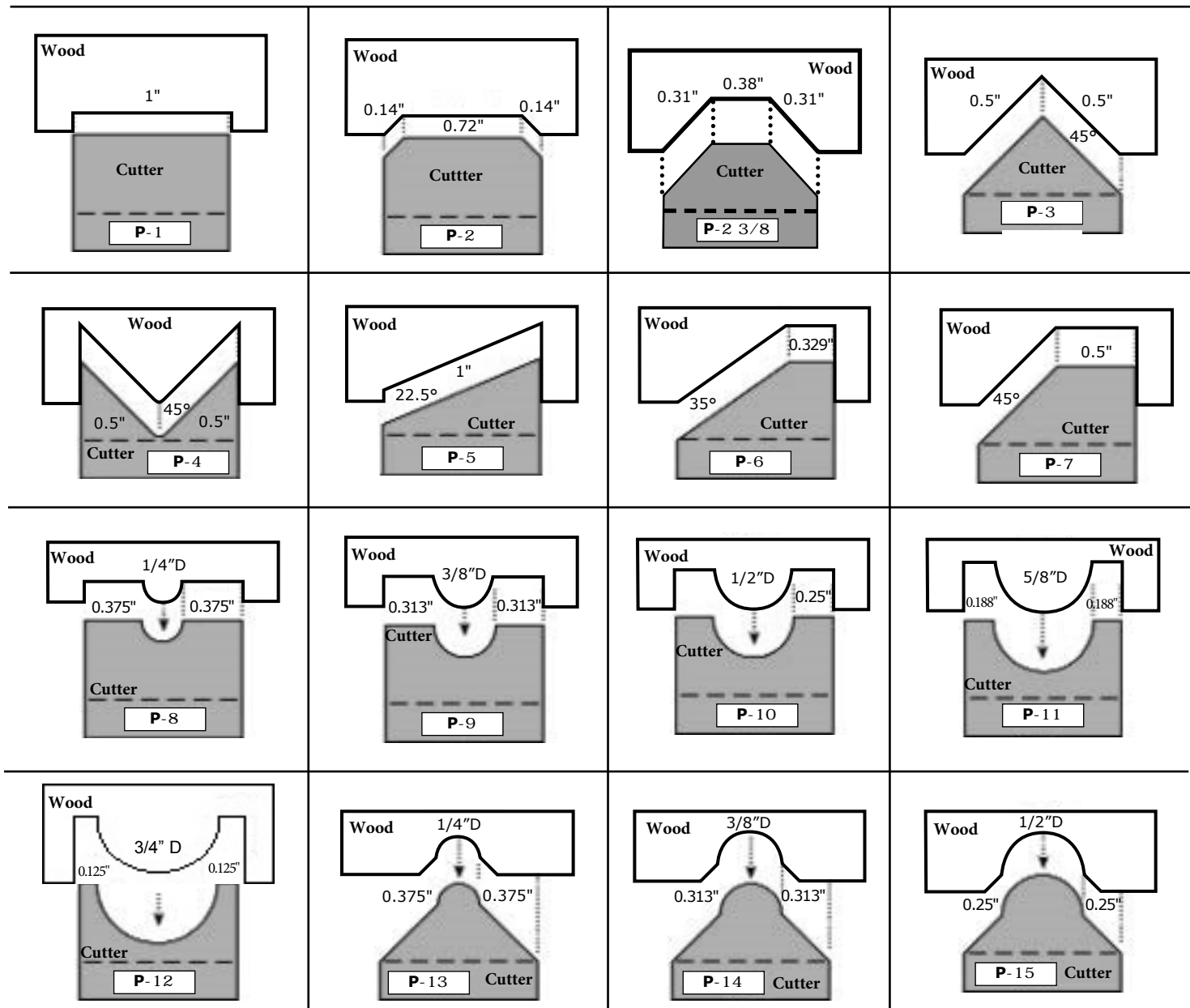

The Magic Molder

Magic Molder Plugs

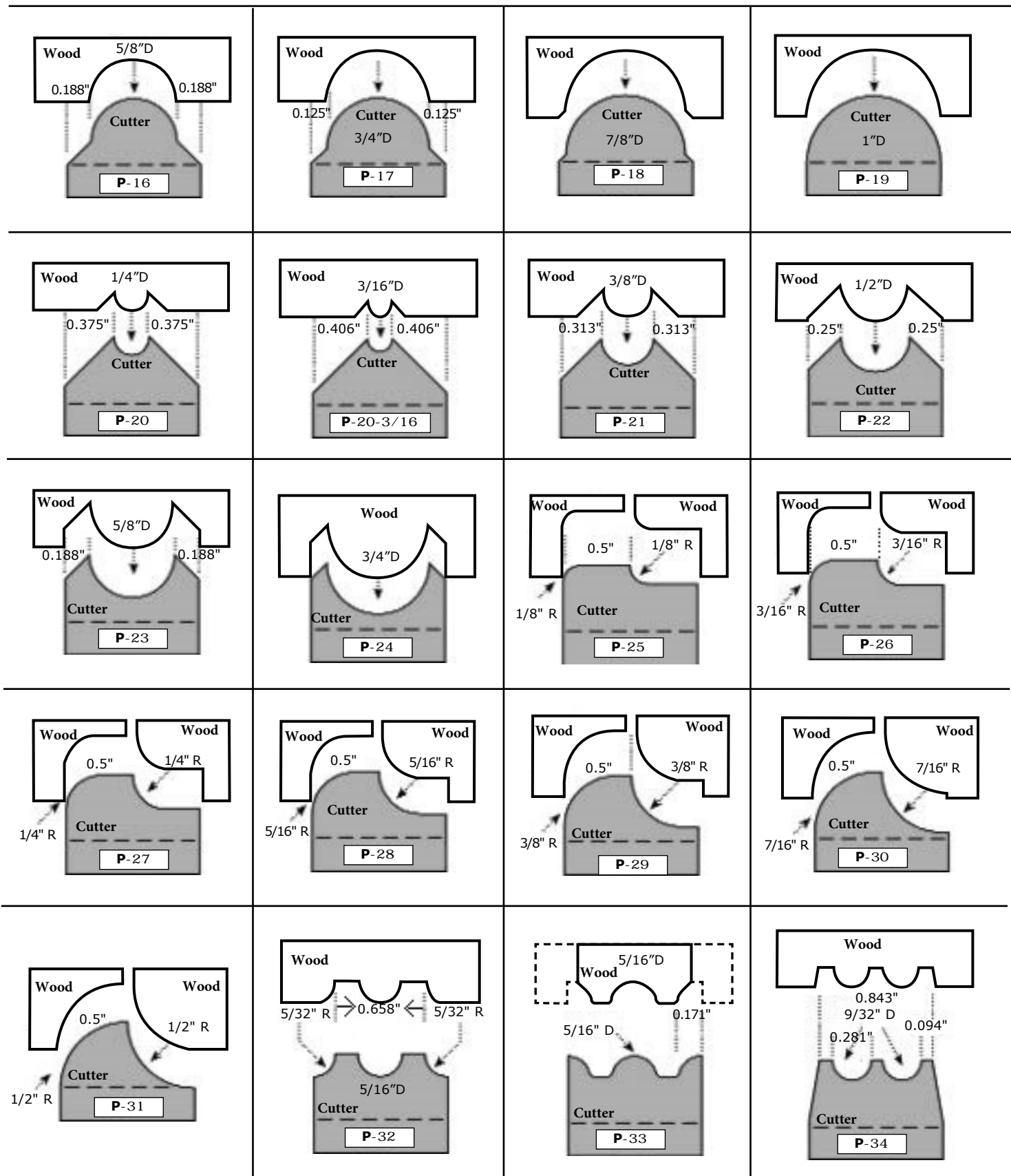

The Magic Molder

Magic Molder Plugs (cont.)

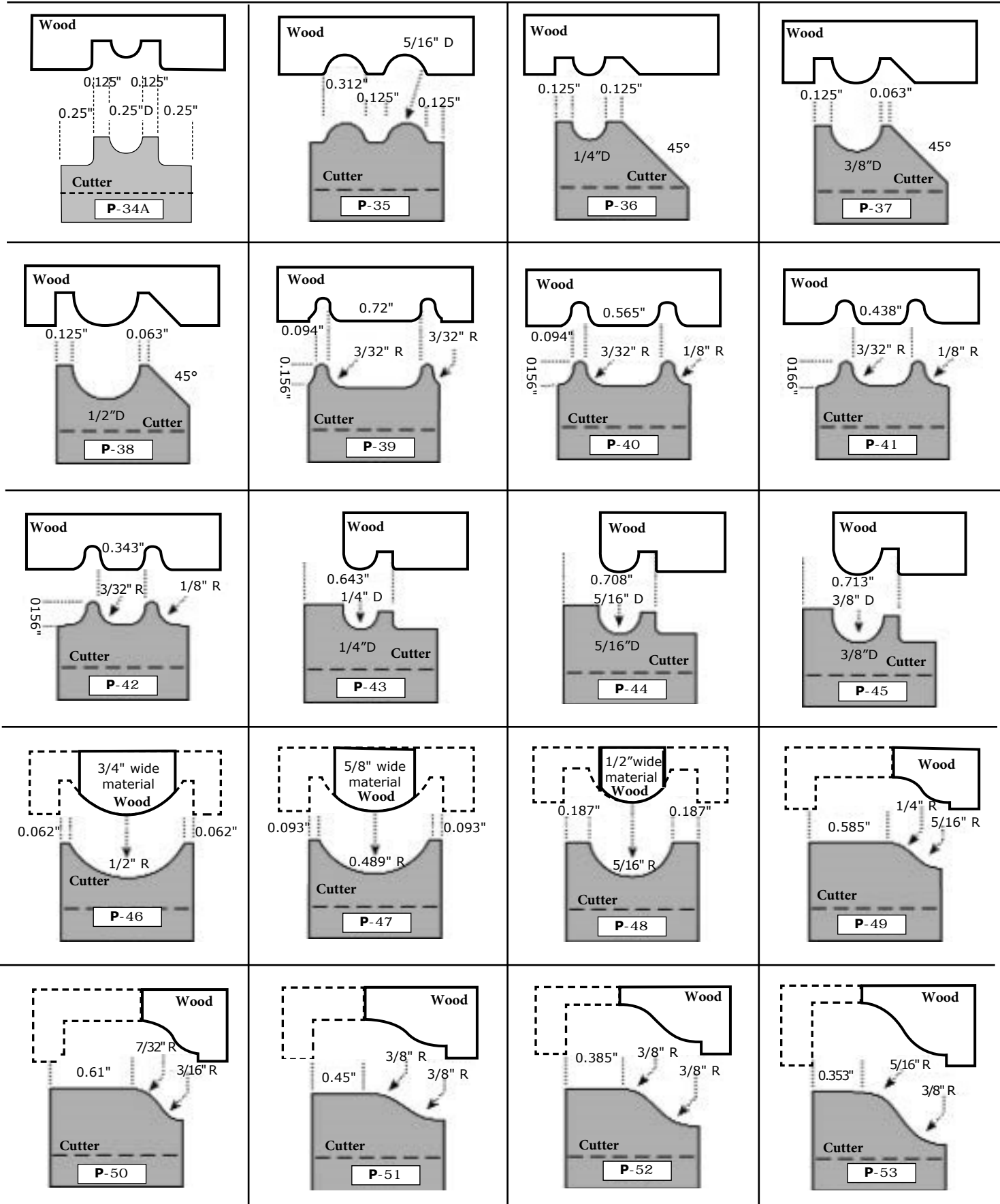

The Magic Molder

Magic Molder Plugs (cont.)

<p>Wood 0.6" 1/4" R 9/64" R Cutter P-54</p>	<p>Wood 0.563" 1/4" R 9/64" R Cutter P-55</p>	<p>Wood 0.375" 1/4" R 5/16" R Cutter P-56</p>	<p>Wood 0.076" 9/16" R 11/16" R 0.375" R Cutter P-57</p>
<p>Wood 5/8" R 0.104" 0.25" R 3/4" R Cutter P-58</p>	<p>Wood 7/32" R 0.891" R 1/8" R 7/16" R Cutter P-59</p>	<p>Wood 0.891" R 7/16" R 3/16" R Cutter P-60</p>	<p>Wood 3/16" R 0.156" R 9/32" R Cutter P-61</p>
<p>Wood 7/32" R 0.143" R 3/8" R Cutter P-62</p>	<p>Wood 5/32" R 7/16" R Cutter P-63</p>	<p>Wood 3/8" R 0.625" R 3/16" R 0.375" R Cutter P-64</p>	<p>Wood 1/8" R 0.313" R 0.25" R 1/4" R 0.25" R Cutter P-65</p>
<p>Wood 0.75" R 1/8" R 0.422" R 7/32" R 1/4" R Cutter P-66</p>	<p>Wood 1/2" wide material 1/8" R 0.658" R 7/32" R 9/64" R 7/32" R Cutter P-67</p>	<p>Wood 0.656" R 9/64" R 3/8" D Cutter P-68</p>	<p>Wood 0.765" R 3/16" R 3/8" D Cutter P-69</p>
<p>Wood 0.78" R 7/32" D 7/32" D 3/4" R Cutter P-70</p>	<p>Wood 3/16" D 3/32" R 3/32" R 3/16" D Cutter P-71</p>	<p>Wood 9/32" D 9/64" R 9/64" R 9/32" D Cutter P-72</p>	

The Magic Molder

Magic Molder Plugs (cont.)

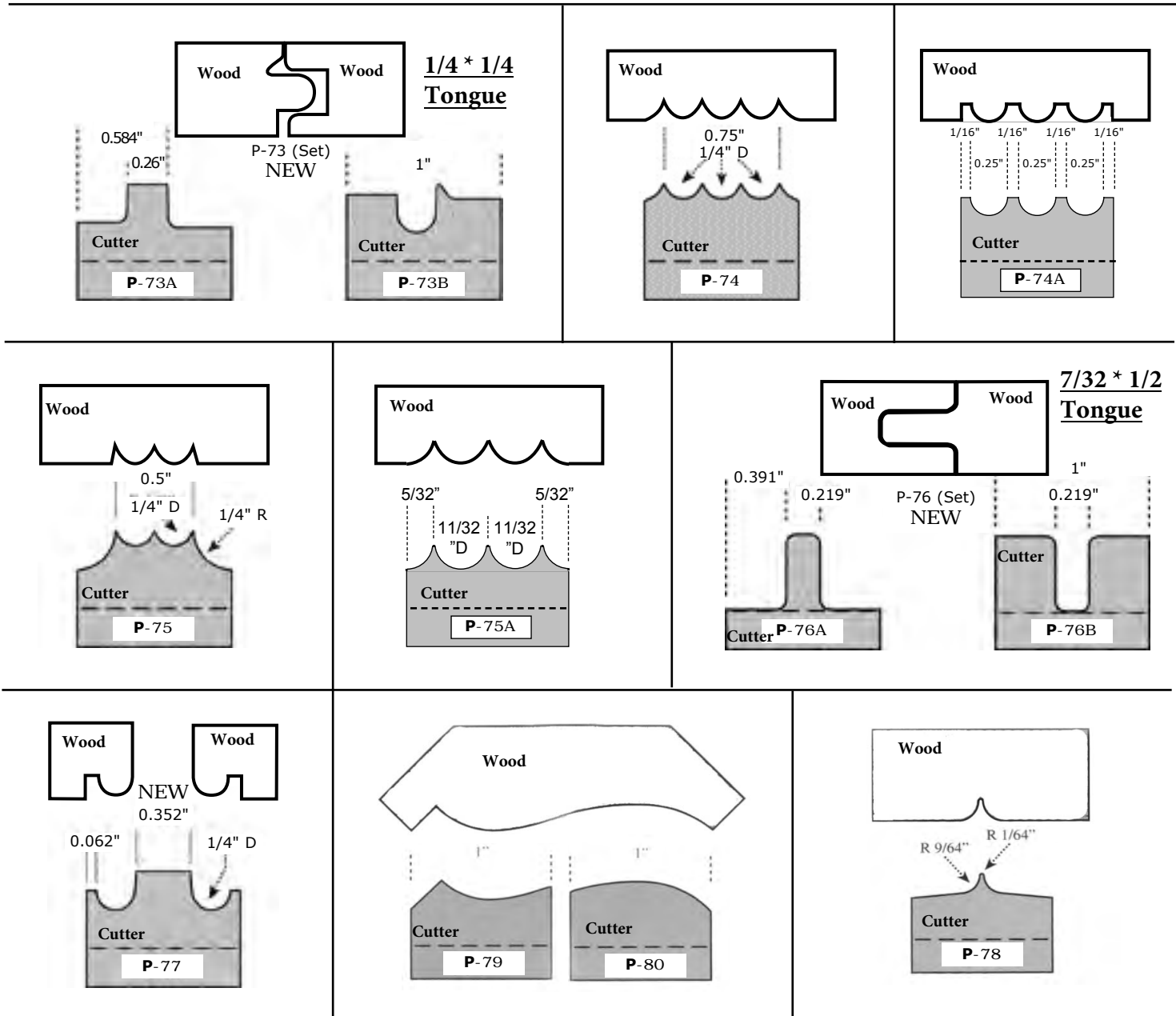

CUSTOM PLUG SETS ARE AVAILABLE \$199 / SET

- 1) Plugs can be no wider than 1".
- 2) Plugs only have clearance to cut 1/2" deep.
- 3) Need 1 week to manufacture after approval drawing.

MIRKA

The 17 Series (Carat/Gray) has been discontinued and replaced with the 22 Series (Base Cut).

First class performance. Ideally suited for wood & composites.

5" PSA Base Cut - No Hole Linkrol

PART	GRIT	QUANTITY	PRICE
22-314-080	80	100	\$18.55
22-314-100	100	100	\$17.50
22-314-120	120	100	\$17.50
22-314-150	150	100	\$17.50
22-314-180	180	100	\$17.50
22-314-220	220	100	\$17.50
22-314-320	320	100	\$17.50
22-314-400	400	100	\$17.50
105 DA Pad			\$19.60

Gold Flex(Soft) Alumnum Oxide Foam Backing

PART	GRIT	QUANTITY	PRICE
23-145-150	150	1 Roll	\$62.65
23-145-180	180	1 Roll	\$62.65
23-145-240	240	1 Roll	\$62.65
23-145-320	320	1 Roll	\$62.65
23-145-400	400	1 Roll	\$62.65
23-145-500	500	1 Roll	\$62.65

4-1/2 x 5 x 1/16 foam backing comes in roll.
 Perforations between pieces.
 200 pieces per roll
 Hard & soft wood, lacquers, paint sanding

5" PSA Vac. Disc - 8 Hole

PART	GRIT	QUANTITY	PRICE
23-320-080	80	100	\$31.85
23-320-100	100	100	\$31.85
23-320-120	120	100	\$31.85
23-320-150	150	100	\$31.85
23-320-180	180	100	\$27.30
23-320-220	220	100	\$27.30

5" Gold PSA Disc - No Hole

PART	GRIT	QUANTITY	PRICE
23-332-036	36	50	\$40.25
23-332-040	40	50	\$36.75
23-332-060	60	50	\$17.15
23-332-080	80	100	\$31.85
23-332-100	100	100	\$27.30
23-332-120	120	100	\$27.30
23-332-150	150	100	\$27.30
23-332-180	180	100	\$27.30
23-332-220	220	100	\$27.30
23-332-320	320	100	\$27.30
23-332-400	400	100	\$27.30
105 DA Pad			\$20.65

5" Gold PSA Disc - No Hole Linkrol

PART	GRIT	QUANTITY	PRICE
23-314-100	100	100	\$27.30
23-314-120	120	100	\$27.30
23-314-150	150	100	\$27.30
23-314-180	180	100	\$27.30
23-314-220	220	100	\$27.30
23-314-320	320	100	\$27.30
23-314-400	400	100	\$27.30

5" Gold PSA Vac Disc - 5 Hole Linkrol

PART	GRIT	QUANTITY	PRICE
23-315-080	80	100	\$31.85
23-315-100	100	100	\$27.30
23-315-120	120	100	\$27.30
23-315-150	150	100	\$27.30
23-315-180	180	100	\$27.30
23-315-220	220	100	\$27.30
105V DA Pad			\$22.05

5" Gold Grip Velcro Discs - No Hole

PART	GRIT	QUANTITY	PRICE
23-612-036	36	50	\$43.40
23-612-040	40	50	\$40.25
23-612-060	60	50	\$20.30
23-612-080	80	50	\$20.30
23-612-100	100	50	\$17.85
23-612-120	120	50	\$17.85
23-612-150	150	50	\$17.85
23-612-180	180	50	\$17.85
23-612-220	220	50	\$17.85
23-612-240	240	50	\$17.85
23-612-320	320	50	\$17.85
23-612-400	400	50	\$17.85
105GG DA Pad			\$22.40

MIRKA**5" Gold Grip Velcro - 5 Hole (Vacuum)**

PART	GRIT	QUANTITY	PRICE
23-614-060	60	50	\$23.30
23-614-080	80	50	\$23.30
23-614-100	100	50	\$17.85
23-614-120	120	50	\$17.85
23-614-150	150	50	\$17.85
23-614-180	180	50	\$17.85
23-614-220	220	50	\$17.85
23-614-240	240	50	\$17.85
23-614-280	280	50	\$17.85
23-614-320	320	50	\$17.85
23-614-400	400	50	\$17.85
23-614-600	600	50	\$17.85
23-614-800	800	50	\$17.85
23-614-AP	*	50	\$19.60

* Assortment Pack. Contains 10 discs of 80,100,120,150, 220 grit.

**5" Gold Grip Velcro - 8 Hole (Vacuum)
for Bosch, Ryobi, Makita, Dewalt**

PART	GRIT	QUANTITY	PRICE
23-615-060	60	50	\$23.30
23-615-080	80	50	\$23.30
23-615-100	100	50	\$17.85
23-615-120	120	50	\$17.85
23-615-150	150	50	\$17.85
23-615-180	180	50	\$17.85
23-615-220	220	50	\$17.85
23-615-240	240	50	\$17.85
23-615-320	320	50	\$17.85
23-615-400	400	50	\$17.85
23-615-AP	*	50	\$19.60

* Assortment Pack. Contains 10 discs of 80,100,120,150, 220 grit.

6" Gold PSA Disc - Linkrol

PART	GRIT	QUANTITY	PRICE
23-342-080	80	100	\$46.20
23-342-100	100	100	\$40.25
23-342-120	120	100	\$40.25
23-342-150	150	100	\$40.25
23-342-180	180	100	\$40.25
23-342-220	220	100	\$40.25
23-342-240	240	100	\$40.25
23-342-280	280	100	\$40.25
23-342-320	320	100	\$40.25
23-342-400	400	100	\$40.25
106 DA Pad			\$21.00

6" Gold PSA Disc - No Hole

PART	GRIT	QUANTITY	PRICE
23-341-036	36	50	\$58.50
23-341-060	60	50	\$25.55

**6" Gold PSA Vac Disc - 6 Hole
Porter Cable**

PART	GRIT	QUANTITY	PRICE
23-343-080	80	100	\$46.20
23-343-100	100	100	\$40.25
23-343-120	120	100	\$40.25
23-343-150	120	100	\$40.25
23-343-180	180	100	\$40.25
23-343-220	220	100	\$40.25
23-343-320	320	100	\$40.25
23-343-400	400	100	\$40.25
106V DA Pad			\$22.40

**6" Gold Grip Velcro - 6 Hole (Vacuum)
for Bosch, Porter Cable**

PART	GRIT	QUANTITY	PRICE
23-624-060	60	50	\$30.10
23-624-080	80	50	\$30.10
23-624-100	100	50	\$26.25
23-624-120	120	50	\$26.25
23-624-150	150	50	\$26.25
23-624-180	180	50	\$26.25
23-624-220	220	50	\$26.25
23-624-320	320	50	\$26.25
23-624-400	400	50	\$26.25
23-624-500	500	50	\$26.25
23-624-600	600	50	\$26.25
23-624-800	800	50	\$26.25

9" x 11" Base Cut

PART	GRIT	QUANTITY	PRICE
22-101-060	60	50	\$23.10
22-101-080	80	50	\$23.10
22-101-100	100	50	\$20.65
22-101-120	120	50	\$20.65
22-101-150	150	50	\$20.65
22-101-180	180	50	\$20.65
22-101-220	220	50	\$20.65
22-101-320	320	50	\$20.65
22-101-400	150	50	\$20.65

MIRKA

9" x 11" Waterproof Paper

PART	GRIT	QUANTITY	PRICE
21-104-P100	100	25	\$18.20
21-104-P120	120	25	\$18.20
21-104-P150	150	25	\$18.20
21-104-P180	180	50	\$34.30
21-104-P220	P-220	50	\$34.30
21-104-P240	P-240	50	\$34.20
21-104-P320	P-320	50	\$34.20
21-104-P360	P-360	50	\$34.20
21-104-P400	P-400	50	\$34.20
21-104-P500	P-500	50	\$34.20
21-104-P600	P-600	50	\$34.20
21-104-P800	P-800	50	\$34.20
21-104-P1000	P-1000	50	\$34.20
21-104-P1200	P-1200	50	\$34.20
21-104-P1500	P-1500	50	\$36.40
21-104-P2000	P-2000	50	\$36.40
21-104-P2500	P-2500	50	\$36.40

Gold PSA 4-1/2" x 10 Yard Rolls

PART	GRIT	PRICE
23-573-080	80	\$25.55
23-573-100	100	\$22.75
23-573-120	120	\$22.75
23-573-150	150	\$22.75
23-573-180	180	\$22.75
23-573-220	220	\$22.75
23-573-320	320	\$22.75
23-573-400	400	\$22.75

Hook and Loop 3" x 25 Yard Rolls for Woodmaster, RBI and Grizzly

PART	GRIT	PRICE
38-325-040	40	\$27.06
38-325-060	60	\$27.06
38-325-080	80	\$27.06
38-325-100	100	\$27.06
38-325-120	120	\$27.06
38-325-150	150	\$27.06
38-325-180	180	\$27.06
38-325-220	220	\$27.06

Hook and Loop 6" x 25 Yard Rolls for Woodmaster, RBI and Grizzly

PART	GRIT	PRICE
38-625-040	40	\$48.66
38-625-060	60	\$48.66
38-625-080	80	\$48.66
38-625-100	100	\$48.66
38-625-120	120	\$48.66
38-625-150	150	\$48.66
38-625-180	180	\$48.66
38-625-220	220	\$48.66

"J" WT-Cloth Double Sided Abrasive Sponge

PART	GRIT	QUANTITY	PRICE
1350-100	100	10	\$10.85
1350-150	150	10	\$10.85
1350-180	180	10	\$10.85
1350-220	220	10	\$10.85

Four Sided Abrasive Sponge 2.75" x 3.94" x 1"

PART	GRIT	QUANTITY	PRICE
1352-M	60	10	\$11.20
1352-F	100	10	\$11.20
1352-VF	180	10	\$11.20

One Sided Abrasive Sponge 4.5" x 5.5" x .25"

PART	GRIT	QUANTITY	PRICE
1355-150	150	20	\$19.25
1355-220	220	20	\$19.25

Abralon 8A Series

PART	GRIT	QUANTITY	PRICE
8A-241-180	180	20	\$68.95
8A-241-360	360	20	\$68.95
8A-241-500	500	20	\$68.95
8A-241-1000	1000	20	\$68.95
8A-241-2000	2000	20	\$68.95
8A-241-3000	3000	20	\$68.95
8A-241-4000	4000	20	\$68.95
8A-241-AP	*	12	\$56.70

* Assortment Pack. Contains 2 discs of each grit 180, 360, 500,1000, 2000 and 4000 Interface Grip DA Pad

6" x 9" Scuff Pads

PART	COLOR	GRIT	QUANTITY	PRICE
18-111-447	Maroon	360	20	\$18.20
18-111-448	Gray	1500	20	\$18.20

MIRKA

Vinyl Faced Backup Pads PSA - No Hole

PART	SIZE	FACE	ATTACHMENT	PIECES	PRICE
105	5"	Vinyl	5/16 x 24	1	\$20.65
106	6"	Vinyl	5/16 x 24	1	\$21.00

5" PSA Vac. Backup Pads - 5 Hole

PART	SIZE	FACE	ATTACHMENT	PIECES	PRICE
105V	5"	Vinyl	5/16 x 24	1	\$22.05
105SV	5"	Vinyl	5/16 x 24	1	\$24.85

6" Backup Pads - 6 Hole

PART	SIZE	FACE	ATTACHMENT	PIECES	PRICE
106V	6"	Vinyl	5/16 x 24	1	\$22.40

Grip Faced Backup Pads - No Hole

PART	SIZE	FACE	ATTACHMENT	PIECES	PRICE
105GG	5"	Vinyl	5/16 x 24	1	\$22.40
105SG	5"	Vinyl	5/16 x 24	1	\$24.85
106GG	6"	Vinyl	5/16 x 24	1	\$23.80

Grip Faced Interface Backup Pads

PART	SIZE	FACE	ATTACHMENT	PIECES	PRICE
1055Y	4-7/8"	Gripped	Faced Pad	5	\$36.40
1066	6"	Gripped	Faced Pad	5	\$39.90

Abranet 9A Series Mesh Abrasives
5" Vacuum Grip Discs

PART	GRIT	QUANTITY	PRICE
9A-232-080	80	50	\$39.90
9A-232-100	100	50	\$35.00
9A-232-120	120	50	\$35.00
9A-232-150	150	50	\$35.00
9A-232-180	180	50	\$35.00
9A-232-220	220	50	\$35.00
9A-232-240	240	50	\$35.00
9A-232-320	320	50	\$35.00
9A-232-400	400	50	\$35.00
9A-232-500	500	50	\$35.00
9A-232-600	600	50	\$35.00
9A-232-800	800	50	\$35.00
9A-232-1000	1000	50	\$35.00
915GV	5/16 x 24 Abranet DA Pad		\$32.90

Abranet 9A Series Mesh Abrasives
6" Vacuum Grip Discs

PART	GRIT	QUANTITY	PRICE
9A-241-080	80	50	\$48.30
9A-241-100	100	50	\$42.00
9A-241-120	120	50	\$42.00
9A-241-150	150	50	\$42.00
9A-241-180	180	50	\$42.00
9A-241-220	220	50	\$42.00
9A-241-240	240	50	\$42.00
9A-241-320	320	50	\$42.00
9A-241-400	400	50	\$42.00
9A-241-600	600	50	\$42.00
9A-241-800	800	50	\$42.00
9A-241-1000	1000	50	\$42.00

Abranet 3" x 4" Mesh Grip Sheets

PART	GRIT	QUANTITY	PRICE
9A-129-80	80	50	\$33.60
9A-129-120	120	50	\$29.40
9A-129-180	180	50	\$29.40
9A-129-240	240	50	\$29.40
9A-129-320	320	50	\$29.40

Abranet Accessories

PART	DESCRIPTION	QTY	PRICE
915GV	5" Grip Face Abranet Vacuum Pad	1	\$34.65
915SGV	5" Soft Face Abranet Vacuum Pad	1	\$34.65
9955	5" Abranet G Pad Protector	5	\$19.95
916GV	6" Grip Face Abranet Vacuum Pad	1	\$35.35
916SGV	6" Soft Face Abranet Vacuum Pad	1	\$35.35
9956	6" Abranet Pad Protector	5	\$24.50
9166	6" Abranet Interface Pad	5	\$44.80
105GVBD	Abranet Pad for Dewalt Elect.Tool	1	\$30.80
105GVPC	Abranet Pad for Porter Cable	1	\$30.80
906GV	6" Abranet DA Pad	1	\$42.70

Miscellaneous & Close Out Items

Mirka Q. Silver is an abrasive with optimal aggressivity to achieve fast and efficient stock removal. The product possesses high heat endurance and is tough in down-to-metal sanding operations, for example in automotive lacquer sanding.

The performance in sanding of hard wood and composites is also extremely good. The backing consists of a flexible and strong impregnated latex paper.

25-608-180, Mirka Q-Silver 5 in. Grip Disc 180G, Qty. 50

23-612-220, Mirka Q-Silver 5 in. Grip Disc 220G, Qty. 50

2B-612-400, Mirka Q-Silver 5 in. Grip Disc 400G, Qty. 50



72" Band Saw Blades

PART	WIDTH	TPI	GAUGE	PRICE
72X1/8X4TR	1/8	4 Skip	.025	\$14.15
72X3/16X4TS	3/16	4 Skip	.025	\$11.90
72X1/2X3TH	1/2	3 Hook	.025	\$11.90
72X1/2X10TR	1/2	10 Regular	.025	\$11.90

80" Band Saw Blades

PART	WIDTH	TPI	GAUGE	PRICE
80 X 1/8 X 14TR	1/8	14 Raker	.025	\$15.44
80 X 3/16 X 4TS	3/16	4 Skip	.025	\$12.89
80 X 1/4 X 4TS	1/4	4 Skip	.025	\$12.89
80 X 1/4 X 6TS	1/4	6 Skip	.025	\$12.89
80 X 3/8 X 4TS	3/8	4 Skip	.025	\$12.89
80 X 1/2 X 3TS	1/2	3 Hook	.025	\$12.89

82" Band Saw Blades

PART	WIDTH	TPI	GAUGE	PRICE
82X1/8X14TR	1/8	14 Raker	.025	\$15.44
82X3/16X4TS	3/16	4 Skip	.025	\$12.89
82X1/4X4TS	1/4	4 Skip	.025	\$12.89
82X1/4X6TS	1/4	6 Skip	.025	\$12.89
82X3/8X4TS	3/8	4 Skip	.025	\$12.89

93-1/2" Band Saw Blades

PART	WIDTH	TPI	GAUGE	PRICE
93-1/2X1/8X14TR	1/8	14 Raker	.025	\$16.61
93-1/2X3/16X4TS	3/16	4 Skip	.025	\$13.74
93-1/2X1/4X4TS	1/4	4 Skip	.025	\$13.74
93-1/2X1/4X6TS	1/4	6 Skip	.025	\$13.74
93-1/2X3/8X4TS	3/8	4 Skip	.025	\$13.74
93-1/2X1/2X3TS	1/2	3 Skip	.025	\$13.74
93-1/2X1/2X14TR	1/2	14 Raker	.025	\$13.74
93-1/2X3/4X3H	3/4	3 Hook	.032	\$17.04

96" Band Saw Blades

PART	WIDTH	TPI	GAUGE	PRICE
96 X 1/8 X 14 TR	1/8	14 Raker	.025	\$17.28
96 X 3/16 X 4 TS	3/16	4 Skip	.025	\$14.28
96 X 1/4 X 4 TS	1/4	4 Skip	.025	\$14.28
96 X 1/4 X 6 TS	1/4	6 Skip	.025	\$14.28
96 X 3/8 X 4 TS	3/8	4 Skip	.025	\$14.28
96 X 1/2 X 4 TH	1/2	4 Hook	.025	\$14.28
96 X 3/4 X 3 TH	3/4	3 Hook	.032	\$17.70

99" Band Saw Blades

PART	WIDTH	TPI	GAUGE	PRICE
99 X 1/8 X 14TR	1/8	14 Raker	.025	\$17.28
99 X 3/16 X 4TS	3/16	4 Skip	.025	\$14.28
99 X 1/4 X 4TS	1/4	4 Skip	.025	\$14.28
99 X 1/4 X 6TS	1/4	6 Skip	.025	\$14.28
99 X 3/8 X 4TS	3/8	4 Skip	.025	\$14.28
99 X 1/2 X 4 TS	1/2	3 Skip	.025	\$14.28
99 X 3/4 X 3TH	3/4	3 Hook	.032	\$17.70

102" Band Saw Blades

PART	WIDTH	TPI	GAUGE	PRICE
102 X 1/8 X 14 TR	1/8	14 Raker	.025	\$17.94
102 X 3/16 X 4 TS	3/16	4 Skip	.025	\$14.71
102 X 1/4 X 4 TS	1/4	4 Skip	.025	\$14.71
102 X 1/4 X 6 TS	1/4	6 Skip	.025	\$14.71
102 X 3/8 X 4 TS	3/8	4 Skip	.025	\$14.71
102 X 1/2 X 3 TH	1/2	3 Hook	.025	\$14.71
102 X 3/4 X 3 TH	3/4	3 Hook	.032	\$18.33

OLSON

OLSON Saw

**Call Ballew Saw and Tool to order
your Olson Custom Blades!**

We stock additional sizes. Please call.

(Minimum 3 custom blades)

105" Band Saw Blades

PART	WIDTH	TPI	GAUGE	PRICE
105 X 1/8 X 14TR	1/8	14 Raker	.025	\$17.89
105 X 3/16 X 4TS	3/16	4 Skip	.025	\$14.71
105 X 1/4 X 4TS	1/4	4 Skip	.025	\$14.71
105 X 1/4 X 6TS	1/4	6 Skip	.025	\$14.71
105 X 3/8 X 4TS	3/8	4 Skip	.025	\$14.71
105 X 1/2 X 3TH	1/2	3 Hook	.025	\$14.71
105 X 3/4 X 3TH	3/4	3 Hook	.032	\$18.33

123" Band Saw Blades

PART	WIDTH	TPI	GAUGE	PRICE
123 X 1/8 X 14TR	1/8	14 Raker	.025	\$19.83
123 X 1/4 X 6TS	1/4	6 Skip	.025	\$16.10
123 X 1/2 X 3TH	1/2	3 Skip	.025	\$16.10
123 X 3/4 X 3TH	3/4	3 Hook	.032	\$20.25

133" Band Saw Blades

PART	WIDTH	TPI	GAUGE	PRICE
133 X 1/8 X 14TR	1/8	14 Raker	.025	\$21.74
133 X 3/16 X 4TS	3/16	4 Skip	.025	\$17.55
133 X 1/4 X 4TS	1/4	4 Skip	.025	\$17.55
133 X 1/4 X 6TS	1/4	6 Skip	.025	\$17.55
133 X 3/8 X 4TS	3/8	4 Skip	.025	\$17.55
133 X 1/2 X 4TS	1/2	4 Skip	.025	\$17.55
133 X 3/4 X 3TH	3/4	3 Hook	.032	\$22.14
133 X 1 X 3TH	1	3 Hook	.032	\$24.80

137" Band Saw Blades

PART	WIDTH	TPI	GAUGE	PRICE
137 X 1/4 X 4TS	1/4	4 Skip	.025	\$17.75
137 X 3/8 X 4TS	3/8	4 Skip	.025	\$17.75
137 X 1/2 X 3TS	1/2	3 Skip	.025	\$17.75
137 X 3/4 X 3TH	3/4	3 Hook	.032	\$22.14
137 X 1 X 3TH	1	3 Hook	.035	\$24.80
137 X 1-1/4 X 1.3TH	1-1/4	12 Hook	.035	\$32.58

150" Band Saw Blades

PART	WIDTH	TPI	GAUGE	PRICE
150 X 1/4 X 4TS	1/4	4 Skip	.025	\$18.41
150 X 3/8 X 4TS	3/8	4 Skip	.025	\$18.41
150 X 1/2 X 3TS	1/2	3 Skip	.025	\$18.41
150 X 3/4 X 3TH	3/4	3 Hook	.032	\$23.53

156-1/2" Band Saw Blades

PART	WIDTH	TPI	GAUGE	PRICE
156-1/2 X 1/8 X 14TR	1/8	14 Raker	.025	\$22.60
156-1/2 X 3/16 X 4TS	3/16	4 Skip	.025	\$19.39
156-1/2 X 1/4 X 4TS	1/4	4 Skip	.025	\$19.39
156-1/2 X 1/4 X 6TS	1/4	6 Skip	.025	\$19.39
156-1/2 X 3/8 X 4TS	3/8	4 Skip	.025	\$19.39
156-1/2 X 1/2 X 4TS	1/2	4 Skip	.025	\$19.39
156-1/2 X 3/4 X 3TH	3/4	3 Hook	.032	\$24.80
156-1/2 X 1 X 3TH	1	3 Hook	.032	\$27.80

ONSRUD Single Flute - High Speed Steel O Flute Straight

10-00

Combines an open flute design with single flute geometry to provide optimum chip removal at fast feed rates. Excellent for hand-fed operations.

Usage ABS, polycarbonate, polyethylene, PVC, polypropylene, polystyrene, extruded acrylic, HDPE, UHMW, and natural wood

Material SW SP

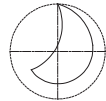

Part Number	Cutting DIA	Flute LGTH	SHK DIA	OAL	Price
10-00	1/16	3/16	1/4	2	\$9.84
10-01	3/32	3/8	1/4	2	\$9.32
10-02	1/8	3/8	1/4	2	\$9.84
10-20	1/8	1/2	1/4	2	\$10.76
10-22	3/16	3/4	1/4	2	\$10.48
10-06	1/4	3/4	1/4	2-1/8	\$7.96
10-07	1/4	1	1/4	2-3/8	\$8.12
10-78	1/4	1-1/4	1/4	2-5/8	\$9.16



Single & Double Flute - High Speed Steel O Flute Straight

11-00

Designed for cutting softer more flexible plastics. Single flute for faster feed rates. Double flute for smoother finish. Excellent for hand-fed operations.

Usage ABS, polycarbonate, polyethylene, polystyrene, PVC, polypropylene extruded acrylic, HDPE, UHMW

Material SP HP

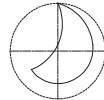

Single Flute

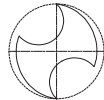

Double Flute

SINGLE FLUTE

Part Number	Cutting DIA	Flute LGTH	SHK DIA	OAL	Price
11-01	1/8	1/2	1/4	2	\$13.16
11-75*	1/8	5/8	1/4	3-1/4	\$15.36
11-03	3/16	5/8	1/4	3-1/4	\$10.48
11-77*	3/16	3/4	1/4	3-1/4	\$12.20
11-05	1/4	3/4	1/4	2-1/8	\$9.16
11-71*	1/4	3/4	1/4	3-1/4	\$12.04
11-07	1/4	1	1/4	2-3/8	\$10.32
11-09	3/8	1	3/8	2-1/2	\$14.24

DOUBLE FLUTE

Part Number	Cutting DIA	Flute LGTH	SHK DIA	OAL	Price
11-00	3/16	5/8	1/4	2	\$13.68
11-02	1/4	3/4	1/4	2-1/8	\$10.48
11-72*	1/4	3/4	1/4	3-1/4	\$13.16
11-76*	1/4	3/4	1/4	3-3/4	\$14.20
11-04	1/4	1	1/4	2-3/8	\$11.56
11-78*	1/4	2	1/4	3-1/4	\$19.04
11-06	3/8	1	3/8	2-1/2	\$16.68
11-74*	3/8	1	3/8	3-1/2	\$19.44

*These tools are designed and toleranced for Air Routers with guide bushing.



Double Flute - High Speed Steel V Flute Straight

12-00

These V flutes are often selected when a balanced tool is critical for smooth finish. A universal tool used in many environments. Excellent for hand-fed applications.

Usage Foam and natural wood

Material HW FP

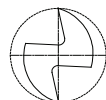

Part Number	Cutting DIA	Flute LGTH	SHK DIA	OAL	Price
12-00	1/4	3/4	1/4	2-1/8	\$8.24
12-79*	1/4	1	1/4	3-1/4	\$11.28
12-35	1/4	1	1/2	2-1/2	\$19.28
12-05	3/8	1	3/8	2-1/2	\$14.00
12-10	1/2	1-1/4	1/2	2-3/4	\$19.04

* These tools are designed and toleranced for Air Routers with guide bushing.



ONSRUD

15-50



Designed to rout steel doors.

Usage Metal clad doors (15-50 and TIN15-50)
Fiberglass doors (TIN15-50)

Material 

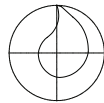

Single Flute - High Speed Steel Dor-Bits

Part Number	Cutting DIA	Flute LGTH	SHK DIA	OAL	Door Machine	Price
15-52	1/2	2-1/4	1/2	5-1/4	RUVO	\$24.32
15-53	1/2	2-1/2	1/2	5-1/2	RUVO	\$26.00
15-54	1/2	2-1/2	1/2	5	ACE	\$26.00
15-55*	1/2	2-1/2	1/2	5-1/2	FALCON	\$26.00
15-57*	1/2	2-1/2	1/2	5-1/2	NORFIELD	\$26.00
15-60	1/2	2-1/2	1/2	5-1/2	RUVO	\$27.16
15-61*	1/2	2-1/2	1/2	5-1/2		\$27.16

HELIX ANGLE = 18° - 32°

*Have Flats

TIN COATED

Part Number	Cutting DIA	Flute LGTH	SHK DIA	OAL	Door Machine	Price
TIN15-52	1/2	2-1/4	1/2	5-1/4	RUVO	\$33.08
TIN15-53	1/2	2-1/2	1/2	5-1/2	RUVO	\$34.76
TIN15-54	1/2	2-1/2	1/2	5	ACE	\$34.76
TIN15-55*	1/2	2-1/2	1/2	5-1/2	FALCON	\$34.76
TIN15-57*	1/2	2-1/2	1/2	5-1/2	NORFIELD	\$34.76
TIN15-60	1/2	2-1/2	1/2	5-1/2	RUVO	\$36.36
TIN15-61*	1/2	2-1/2	1/2	5-1/2		\$36.36

*HAVE FLATS

15-75



Three Flute - High Speed Steel TIN Coated CNC Dor-Bits

Downcut tools designed specifically for machining metal clad doors in a CNC environment. The tool geometry facilitates piercing steel and produces a superior cut for door lites and hardware openings.

Usage Metal clad or fiberglass doors

Material 

TIN COATED

Part Number	Cutting DIA	Flute LGTH	SHK DIA	OAL	Door Machine	Price
TIN15-75	1/2	3	1/2	6	KVAL	\$73.48

HELIX ANGLE = 18°

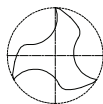

18-00



Single Flute - High Speed Steel Straight Pilot

Straight flute tools with boring points and pilots are the workhorse of the mobile home, modular home and RV industries.

Usage Wood panels, vinyl coated panels, wall board and aluminum materials.

Material 

Part Number	Cutting DIA	Flute LGTH	SHK DIA	OAL	Price
18-00	1/4	3/4	1/4	2-3/4	\$6.64
18-02	3/8	7/8	3/8	2-7/8	\$9.49
18-03	1/2	1	1/2	3-1/2	\$15.28

ONSRUD Single Flute - High Speed Steel Downcut Spiral Pilot 20-00

Spiral tools designed to push chips away from the operator in mobile home and RV manufacturing plants.

Usage Aluminum and plywood sandwich panels, vinyl coated panels, wall board, drywall and layered material

Material CM
DW



Part Number	Cutting DIA	Flute LGTH	SHK DIA	OAL	Price
20-00	1/4	3/4	1/4	3	\$9.32
20-02	3/8	1	3/8	3-7/16	\$11.28
20-03	1/2	1-1/4	1/2	4	\$28.96

HELIX ANGLE = 21° - 38°



Single Flute - High Speed Steel Drywall Bit 20-10

Spiral flute tools designed to make cut outs in drywall. Used in manufactured housing and on site construction.

Usage Drywall cut outs

Material CM
DW

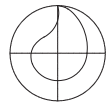

Part Number	Cutting DIA	Flute LGTH	SHK DIA	OAL	Price
20-10	3/16	1	1/4	3-1/4	\$7.76
20-11	1/8	3/4	1/8	2-1/2	\$1.24
20-15	1/8	1	1/8	2-1/2	\$1.24

HELIX ANGLE = 30° - 41°



Single Flute - Solid Carbide Laminate Trim 27-00

Designed to trim counter tops. The pilot bears on the finished surface and acts as a guide to trim flush or with a bevel. Available with boring point if necessary to plunge and rout.

Usage Trimming laminate counter tops and trimming plastic parts

Material LW



Part Number	Cutting DIA	Flute LGTH	SHK DIA	OAL	Style	Price
27-00	1/4	1/4	1/4	1-1/2	Flush	\$12.68
27-01	1/4	1/4	1/4	1-1/2	7° Bevel	\$12.68
27-03	1/4	3/8	1/4	2	Flush	\$14.08

27-00



Double Flute - Solid Carbide Laminate Trim 27-50

Tools with a pilot designed to give a satin smooth finish when trimming laminate counter tops.

Usage Trimming laminate counter tops and trimming plastic parts

Material LW

Part Number	Cutting DIA	Flute LGTH	SHK DIA	OAL	Style	Price
27-50	1/4	7/16	1/4	1-5/8	Flush	\$19.12

27-50



ONSRUD

28-20



Spirals designed to trim stacked sheets of plastic in hand-fed applications. They use a double bearing guide to ensure smooth cutting action around a template.

Usage Trimming stacked sheets plastic & laminates

Material **SP** **HP**

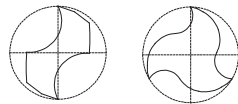

Double Flute Three Flute

Solid Carbide Double-Bearing Plastic Trim

Part Number	Cutting DIA	Flute LGTH	SHK DIA	OAL	Flute	Price
28-20	1/4	3/4	1/4	3	2	\$39.28
28-25	1/2	1-1/8	1/2	4	2	\$109.12

HELIX ANGLE ≈ 11° - 30°

REPLACEMENT BEARING KITS FOR SERIES 28-20 Solid Carbide Double Bearing Plastic Trim Tool Kits

Part Number	Description	Price
28-89	KIT for 28-20 Tool	\$7.56
28-88	KIT for 28-25 Tool	\$15.32

28-50



Carbide Tipped Flush Trim

Designed to provide a smooth finished edge on dense, abrasive and laminated materials. A ball bearing guide assists free cutting action. Excellent for hand-fed applications.

Usage Natural wood, wood composites, laminated and veneered

Material **SW** **HW** **CW**
LW **SP**

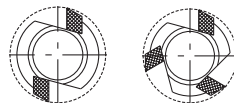

Double Flute Three Flute

Part Number	Cutting DIA	Flute LGTH	SHK DIA	OAL	Flute	Price
28-55	1/4	1	1/4	2-1/2	2	\$27.28
28-51	3/8	1/2	1/4	2-1/4	2	\$21.16
28-50	3/8	1	1/4	2-3/4	2	\$21.16
28-53	1/2	1/2	1/4	2	2	\$21.16
28-57	1/2	1	1/4	2-3/4	3	\$32.04
28-54	1/2	1	1/2	3-1/4	2	\$23.40
28-63	1/2	1-1/2	1/2	4-1/4	2	\$25.08
28-64	1/2	2	1/2	4-1/4	2	\$28.40

29-50



Double Flute - Carbide Tipped Chamfer

Provides a beveled or decorative edge on finished parts.

Usage Natural wood and wood composites

Material **SW** **HW** **CW**

Part Number	Bevel	Flute LGTH	SHK DIA	OAL	Price
29-51	45°	1/2	1/4	2	\$29.52
29-52	45°	1/2	1/2	2-1/2	\$31.04
29-53	25°	3/8	1/4	1-7/8	\$20.32

ONSRUD

29-000



HSS Hollow Core Cutters

This specialized cutter is designed to vertically cut the honeycomb cells producing a clean, flag free edge. The core material will remain attached at the bottom and can be removed using one of our valve style honeycomb cutters. This product along with our 31-100 or 30-000 series tools is an effective combination to create pockets in honeycomb core and get a perfectly clean edge.

Usage Honeycomb

Part Number	Cutting DIA	Flute LGTH	SHK DIA	OAL	Price
29-003	1/4	1-1/2	1/4	3-3/4	\$73.28
29-006	3/8	1-7/8	3/8	3-3/4	\$75.92
29-009	1/2	2-7/8	1/2	5	\$93.88
29-012	5/8	2-7/8	5/8	5	\$156.64
29-015	3/4	2-7/8	3/4	5	\$132.56

29-050



Diamond Grit Hogger

Diamond grit hoggers are used on abrasive cores (graphite, phenolic, or fiberglass) in order to achieve long tool life. The tools are available in a ball nose version and as a traditional hogger capable of holding existing honeycomb blades. A 35% weight reduction has been designed into the larger diameter tools resulting in better performance on 3 or 5 axis machines.

Usage Honeycomb

BALL NOSE



Part Number	Cutting DIA	Flute LGTH	SHK DIA	OAL	Price
29-053	1/4 (6.35mm)	1 1/4	1/4	4	\$230.72
29-058	3/8 (9.52mm)	2 1/2	1/2	4	\$259.40
29-063	1/2 (12.7mm)	3	1/2	5	\$321.68
29-068	3/4 (19.05mm)	3	1/2	5	\$412.00
29-074	1 (25.4mm)	2	3/4	4	\$507.60

HONEYCOMB HOGGER					CUTTING BLADE OPTIONS							SPARE PARTS	
Part #	Cutting Diameter	Hogger Depth	Shank DIA	OAL	Blade Diameter	HSS	HSS w/Teeth	Solid Carbide	Solid Carbide w/Teeth	Diamond Plated	HSS Saw	Adapter Ring	Screw
29-052	1/4 (6.35mm)	1 1/4	1/4	4	-	-	-	-	-	-	-	-	-
29-057	.345 (8.76mm)	2 1/2	1/2	4	3/8 (9.52mm)	30-016	30-316	-	-	-	-	-	HRD51646
29-062	.470 (11.94mm)	3	1/2	5	1/2 (12.7mm)	30-017	30-317	-	-	-	-	-	HRD51646
29-067	.720 (18.28mm)	3	1/2	5	3/4 (19.05mm)	-	-	30-015	30-318	-	-	-	30-011-2
29-072	.970 (24.63mm)	1	1/2	3	1 (25.4mm)	-	-	30-012	30-313	30-113	30-213	-	30-011-2
29-073 ¹	.970 (24.63mm)	2	3/4	5	1 (25.4mm)	-	-	30-012	30-313	30-113	30-213	-	30-011-2
29-078	1.470 (37.33mm)	1	1/2	3	1 1/2 (38.10mm)	-	-	30-014	30-314	30-114	30-214	30-020-3	30-020-4
29-079 ¹	1.470 (37.33mm)	2	3/4	5	1 1/2 (38.10mm)	-	-	30-014	30-314	30-114	30-214	30-020-3	30-020-4
29-083	1.742 (44.24mm)	1	1/2	3	1.772 (45mm)	-	-	30-026	30-326	30-126 ²	30-226 ²	30-020-3	30-020-4
29-084 ¹	1.742 (44.24mm)	2	3/4	5	1.772 (45mm)	-	-	30-026	30-326	30-126 ²	30-226 ²	30-020-3	30-020-4
29-088	1.970 (50.03mm)	1	5/8	3	2 (50.8mm)	-	-	30-022	30-322	30-122	30-222	30-020-3	30-020-4
29-089 ¹	1.970 (50.03mm)	2	3/4	5	2 (50.8mm)	-	-	30-022	30-322	30-122	30-222	30-020-3	30-020-4
29-093	2.450 (62.23mm)	1	5/8	3	2.480 (63mm)	-	-	30-036	30-336	30-136	30-236	30-030-3	30-030-4
29-095	2.970 (75.43mm)	1	3/4	3	3 (76.20mm)	-	-	30-032	30-332	30-132	30-232	30-030-3	30-030-4
29-096 ¹	2.970 (75.43mm)	1	3/4	4	3 (76.20mm)	-	-	30-032	30-332	30-132	30-232	30-030-3	30-030-4
29-098	3.970 (100.83mm)	1	3/4	3	4 (101.6mm)	-	-	30-042	30-342	30-142	30-242	30-040-3	30-040-4
29-099 ¹	3.970 (100.83mm)	1	3/4	4	4 (101.6mm)	-	-	30-042	30-342	30-142	30-242	30-040-3	30-040-4

¹ = non-stock standard. 4 week lead time
² = 50mm diameter honecomb blade

Call for pricing.

ONSRUD

Solid Carbide Honeycomb Hogger (Coated)

Designed to be a versatile tool and cut most honeycomb core materials. The solid carbide body offers long tool life while the proven hogger geometry shreds the core and evacuates chips. The long flute length allows for deep pocket applications and can also be used to surface large areas. Hoggers are coated with ZRN.

Usage Honeycomb

Part Number	Cutting DIA	Flute LGTH	SHK DIA	OAL	Price
29-110	1/4 (6.35mm)	1-1/4	1/4	4	\$99.00
29-115	3/8 (9.52mm)	2	3/8	4	\$125.32
29-125	1/2 (12.7mm)	3	1/2	6	\$138.88
29-130	1/2 (12.7mm)	4-1/2	1/2	6-1/2	\$152.32
29-140	3/4 (19.05mm)	3	3/4	6	\$241.04
29-145	3/4 (19.05mm)	4-1/2	3/4	6-1/2	\$301.80

29-100
29-100B

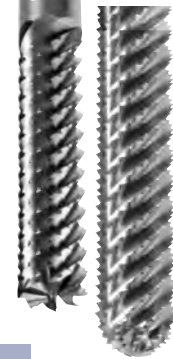

METRIC

Part Number	Cutting DIA	Flute LGTH	SHK DIA	OAL	Price
29-120	12 (.472")	60	12	150	\$137.08
29-135	16 (.629")	80	16	150	\$196.68

BALL NOSE

Part Number	Cutting DIA	Flute LGTH	SHK DIA	OAL	Price
29-130B	1/2 (12.7mm)	4-1/2	1/2	6-1/2	\$179.20
29-140B	3/4 (19.05mm)	3	3/4	6	\$326.40
29-145B	3/4 (19.05mm)	4-1/2	3/4	6-1/2	\$331.52

Replaceable Ring Type Honeycomb Cutter

These tools are for contouring, carving and chamfering cuts of .25" or less. The unique patented holding system prevents the solid carbide blades from coming out of the holder if it is fractured.

The HSS saw blades and the diamond plated blades dish on the bottom so they clear the cut core finish like the hollow ground solid carbide style rings. The solid carbide rings may be reground several times at the factory making them very economical to use.

Usage For contouring, carving and chamfering cuts

The HSS saw and diamond plated blades are disposable, offering the convenience of a constant diameter.

Call for pricing.

30-000



SHANK ASSEMBLY			CUTTING BLADE OPTIONS				SPARE PARTS	
Part #	Blade Diameter	Shank DIA	Solid Carbide	Solid Carbide with Teeth	Diamond Plated	HSS Saw	Adapter Ring	Screw
30-011	1" (25.4mm)	1/2	30-012	30-313	30-112	30-213	-	30-011-2
30-021	2" (50.8mm)	1/2	30-022	30-322	30-122	30-222	30-020-3	30-020-4
30-031	3" (76.2mm)	1/2	30-032	30-332	30-132	30-232	30-030-3	30-030-4
30-041	4" (101.6mm)	1/2	30-042	30-342	30-142	30-242	30-040-3	30-040-4

Cutting Blades for Cutters and Hoggers

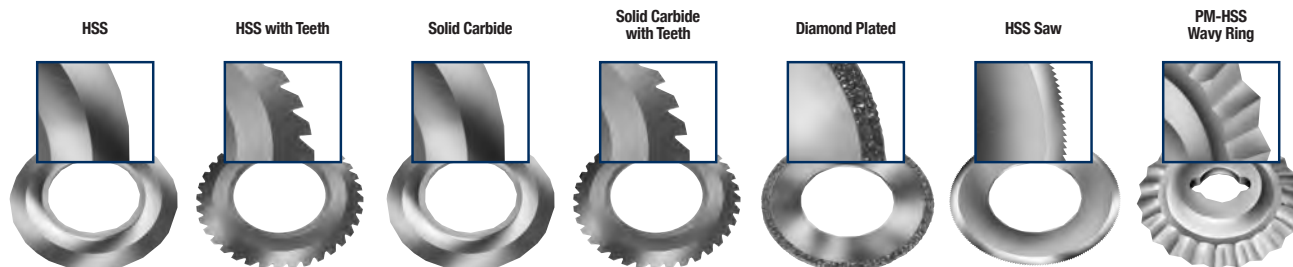

ONSRUD

30-300

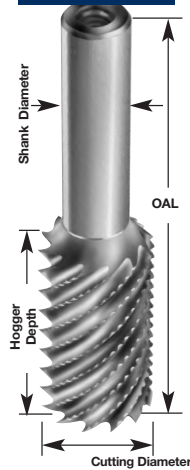

HSS Integral Shank Honeycomb Hogger Cutter

High Speed Steel Hoggers • High Speed Replaceable Saw Blade
Solid Carbide Replaceable Blade • Diamond Plated Replaceable Blade

The spiral hogger geometry ground integral to the shank allows for faster feed rates and deeper cuts than any previous cutter. The availability of several different blades makes this cutter suitable for most core types. The hogger design also imparts less force as it evacuates and shreds scrap.

Usage CNC machining of honeycomb core

Call for pricing.



HONEYCOMB HOGGER					CUTTING BLADE OPTIONS					SPARE PARTS	
Part #	Cutting Diameter	Hogger Depth	Shank DIA	OAL	Blade Diameter	Solid Carbide	Solid Carbide w/Teeth	Diamond Plated	HSS Saw	Adapter Ring	Screw
30-310	7/8 (22.22mm)	1 1/2	1/2	3 1/2	1 (25.4mm)	30-012	30-313	30-113	30-213	-	30-011-2
30-315	1 1/4 (31.75mm)	1 1/2	1/2	3 1/2	1 1/2 (38.1mm)	30-014	30-314	30-114	30-214	30-020-3	30-020-4
30-321	1 3/4 (44.45mm)	1 1/2	1/2	3 1/2	2 (50.8mm)	30-022	30-322	30-122	30-222	30-020-3	30-020-4
30-331	2 3/4 (69.85mm)	1	1/2	3 1/2	3 (76.2mm)	30-032	30-332	30-132	30-232	30-030-3	30-030-4
30-341	3 3/4 (95.25mm)	1	3/4	3 1/2	4 (101.6mm)	30-042	30-342	30-142	30-242	30-040-3	30-040-4

30-700



Reduced Weight Honeycomb Cutter

35% weight reduction has been designed into the larger diameter tools resulting in better performance on 3 or 5 axis machines. Part lifting and flagging have also been reduced due to the new tooth and flute design. Existing honeycomb blades will mount on these hoggers.

Usage CNC Machining of Honeycomb Core

Call for pricing.

HONEYCOMB HOGGER					CUTTING BLADE OPTIONS							SPARE PARTS	
Part #	Cutting Diameter	Hogger Depth	Shank DIA	OAL	Blade Diameter	HSS	HSS w/Teeth	Solid Carbide	Solid Carbide w/Teeth	Diamond Plated	HSS Saw	Adapter Ring	Screw
30-703	.345 (8.76mm)	1	1/2	3	3/8 (9.52mm)	30-016	30-316	-	-	-	-	-	HRD51646
30-705	.470 (11.93mm)	1	1/2	3	1/2 (12.7mm)	30-017	30-317	-	-	-	-	-	HRD51646
30-707	.720 (18.28mm)	1	1/2	3	3/4 (19.05mm)	-	-	30-015	30-318	-	-	-	30-011-2
30-710	.970 (24.63mm)	1	1/2	3	1 (25.4mm)	-	-	30-012	30-313	30-113	30-213	-	30-011-2
30-715	1.470 (37.33mm)	1	1/2	3	1 1/2 (38.10mm)	-	-	30-014	30-314	30-114	30-214	30-020-3	30-020-4
30-720	1.742 (44.24mm)	1	1/2	3	1.772 (45mm)	-	-	30-026	30-326	30-126 ¹	30-226 ¹	30-020-3	30-020-4
30-725	1.970 (50.03mm)	1	5/8	3	2 (50.8mm)	-	-	30-022	30-322	30-122	30-222	30-020-3	30-020-4
30-730	2.450 (62.23mm)	1	5/8	3	2.480 (63mm)	-	-	30-036	30-336	30-136	30-236	30-030-3	30-030-4
30-735	2.970 (75.43mm)	1	3/4	3	3 (76.20mm)	-	-	30-032	30-332	30-132	30-232	30-030-3	30-030-4
30-740	3.970 (100.83mm)	1	3/4	3	4 (101.6mm)	-	-	30-042	30-342	30-142	30-242	30-040-3	30-040-4

1 = 50mm diameter honecomb blade

ONSRUD

High Speed Steel Cutter

Designed primarily for use on aluminum core, offering the versatility of smaller sizes for use on hand-held machines in field or maintenance type repairs. This cutter offers the strength of an integral shank and blade that has an edge sharpness unattainable with any other material. This sharpness and the relieved bottom yield part surfaces that require a minimum of preparation before bonding operation.

Usage Aluminum Core

31-000



Part Number	Cutting DIA	SHK DIA	OAL	Price
31-010	1/2	1/4	2-1/16	\$42.36
31-015	3/4	1/4	2-3/32	\$53.04
31-020	1	1/4	2-1/8	\$58.24
31-025	1-1/2	1/2	2-1/4	\$95.36
31-030	2	1/2	2-3/4	\$159.04
31-040	3	1/2	2-15/16	\$265.00

Core Type	Rating
Aluminum, Lo Density (Less than 5#/cuft)	1
Aluminum, Hi Density (More than 5#/cuft)	2
Paper	2
Paper, Reinforced	N
Fiberglass	N
Phenolic	N
Polycarbonate	N
Aramid	N

1 - Excellent, 2 - Good, N - Not Recommended

High Speed Steel Honeycomb Cutter With Teeth

Small diameter honeycomb cutters were designed to offer the flexibility of cutting small slots or pockets in honeycomb core. The tools are versatile and can be used on CNC machines or hand held machines for field or maintenance type repairs.

Usage For contouring, carving, pocketing, and chamfer cuts

Part Number	Cutting DIA	SHK DIA	OAL	Price
31-102TCN	3/8	1/4	3	\$46.72
31-104TCN	1/2	1/4	3	\$52.80
31-106TCN	5/8	1/4	3	\$59.48
31-108TCN	3/4	1/4	3	\$66.24

31-100



Cutting Blades for Cutters and Hoggers

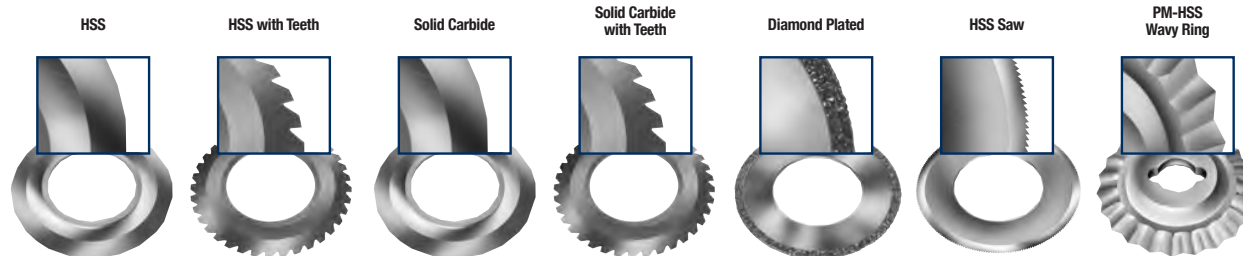

32-000

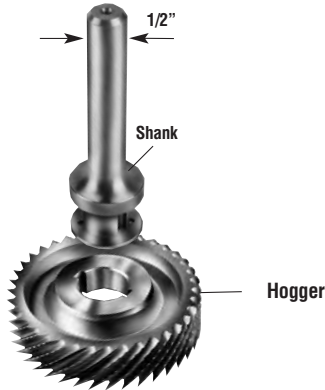

ONSRUD

High Speed Steel Hogger

These cutters are specifically designed for fast (low force) removal of excess core followed by a final finish pass to obtain excellent finishes with one tool. These cutters enable cuts of up to .60" depths in a single pass. The availability of several different blades makes this cutter suitable for most core types.

All assemblies require a shank, hogger and blade.

Usage Fast removal of excess core

Call for pricing.



HONEYCOMB HOGGER			SHANK		CUTTING BLADE OPTIONS					SPARE PARTS	
Part #	Cutting Diameter	Hogger Depth	Part #	Shank DIA	Blade Diameter	Solid Carbide	Diamond Plated	HSS Wavy Ring	HSS Saw	Adapter Ring	Screw
32-022	1.732 (44mm)	.629 (16mm)	32-021	1/2	1.771 (45mm)	32-026	-	32-023	-	-	-
					1.968 (50mm)	-	32-029*	-	32-027*	32-028	-
32-032	2.421 (61.5mm)	.629 (16mm)	32-031	1/2	2.480 (63mm)	32-036	-	32-033	-	-	-
					2.952 (75mm)	-	32-039*	-	32-037*	32-038	-

32-100 - Wrench for 32-000 Tools

* Requires Adapter Ring

32-200



HSS Three Piece Honeycomb Hogger (Coated)

Designed with more aggressive hogger geometry than the 32-000 series. Both the hogger and blade with teeth have a fine tooth grind pattern resulting in increased feed rates and improved part finish. All hoppers and blades are coated with a ZRN coating for increase in tool life. All hogger assemblies require a shank, a hogger and a blade. This design also allows the tool to be use without the hogger by replacing the hogger with a spacer. Torque Spec = 18 in-lb.

Usage Fast removal of excess core

Call for pricing.

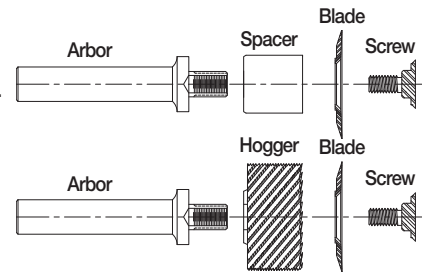

HONEYCOMB HOGGER			SHANK			CUTTING BLADE OPTIONS			SPARE PARTS	
Part #	Cutting Diameter	Hogger Depth	Part #	Shank DIA	OAL	Blade Diameter	Solid Carbide	Solid Carbide w/Teeth	Spacer	Retaining Screw
32-210	0.94" (23.88mm)	1" (25.4mm)	32-221	3/8"	4"	1" (25.4mm)	32-412	32-512	32-221-3	32-221-4
32-225	1.94" (49.28mm)	1" (25.4mm)	32-231	1/2"	4"	2" (50.8mm)	32-422	32-522	32-231-3	32-231-4
			32-241	5/8"	4"					
32-235	2.94" (74.68mm)	1" (25.4mm)	32-231	1/2"	4"	3" (76.2mm)	32-432	32-532	32-231-3	32-231-4
			32-241	5/8"	4"					
32-220	1.72" (43.69mm)	1" (25.4mm)	32-231	1/2"	4"	1.77" (45mm)	32-426	32-526	32-231-3	32-231-4
			32-241	5/8"	4"					
32-230	2.42" (61.47mm)	1" (25.4mm)	32-231	1/2"	4"	2.48" (63mm)	32-436	32-536	32-231-3	32-231-4
			32-241	5/8"	4"					

32-201 - Wrench for 32-200 Tools (for Shank Diameters 1/2" & 5/8")

32-202 - Wrench for 32-200 Tools (for Shank Diameters 3/8")

ONSRUD

Aircraft Panel Tools

This modular tool is designed to produce slots in composite panels so potting compound can be applied to strengthen the edge. This tool consists of a PCD arbor which accepts a diamond grit or HSS under cutting tool to be screwed into it.

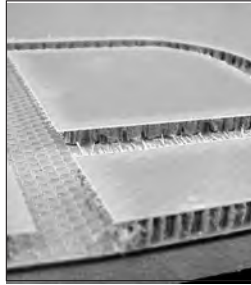

Usage HCC Panels

34-000

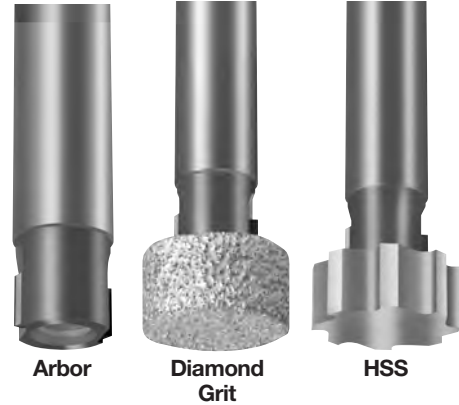

Part Number	Cutting DIA	Flute LGTH	SHK DIA		Price
34-008	1/2	-	1/2	Arbor (non-cutting)	\$156.56
34-010	1/2	1/4	1/2	PCD Arbor Diamond	\$230.72
34-022	7/8	0.130	n/a	Grit Cutter Diamond	\$292.44
34-024	7/8	0.250	n/a	Grit Cutter Diamond	\$292.52
34-026	7/8	0.380	n/a	Grit Cutter Diamond	\$292.64
34-028	7/8	0.500	n/a	Grit Cutter Diamond	\$292.72
34-030	7/8	0.630	n/a	Grit Cutter	\$292.80
34-042	7/8	0.130	n/a	HSS Cutter	\$95.48
34-044	7/8	0.250	n/a	HSS Cutter	\$108.60
34-046	7/8	0.380	n/a	HSS Cutter	\$121.68
34-048	7/8	0.500	n/a	HSS Cutter	\$134.76
34-050	7/8	0.630	n/a	HSS Cutter	\$148.60

Single Flute - Solid Carbide Engraving Tools

The half round engraving tools are offered with a wide range of tip sizes and angles to accommodate many engraving styles.

Usage Wood, plastic, aluminum and solid surface

Material

Part Number	TIP	Angle	SHK DIA	OAL	Price
37-21	0.005	30	1/4	2	\$20.72
37-23	0.010	30	1/4	2	\$20.72
37-25	0.020	30	1/4	2	\$20.72
37-27	0.030	30	1/4	2	\$20.72
37-29	0.040	30	1/4	2	\$20.72
37-31	0.060	30	1/4	2	\$20.72
37-35	0.090	30	1/4	2	\$20.72
37-39	30 Degree Kit				\$145.04

Part Number	TIP	Angle	SHK DIA	OAL	Price
37-01	0.005	60	1/4	2	\$20.72
37-03	0.010	60	1/4	2	\$20.72
37-05	0.020	60	1/4	2	\$20.72
37-07	0.030	60	1/4	2	\$20.72
37-09	0.040	60	1/4	2	\$20.72
37-11	0.060	60	1/4	2	\$20.72
37-15	0.090	60	1/4	2	\$20.72
37-19	60 Degree Kit				\$145.04



METRIC

Part Number	TIP	Angle	SHK DIA	OAL	Price
37-25	0.5mm	30	6mm	50mm	\$20.72
37-27	0.76mm	30	6mm	50mm	\$20.72
37-29	1mm	30	6mm	50mm	\$20.72

METRIC

Part Number	TIP	Angle	SHK DIA	OAL	Price
37-05M	0.5mm	60	6mm	50mm	\$18.76
37-07M	0.76mm	60	6mm	50mm	\$18.76
37-09M	1mm	60	6mm	50mm	\$20.72

ONSRUD

Double Flute - V Bottom

Designed for V grooving or beveling 90°.

Usage Plastic and solid surface, composites, laminated and veneer

Material SW HW CW SP HP SSP LW

SOLID CARBIDE

Part Number	Cutting DIA	Flute LGTH	SHK DIA	OAL	Price
37-50	3/16	5/8	1/4	2	\$34.88
37-51	1/4	3/4	1/4	2	\$33.40
37-52	3/8	3/4	3/8	2-1/2	\$57.84

HELIX ANGLE = 3° - 5° Shear

CARBIDE TIPPED

Part Number	Cutting DIA	Flute LGTH	SHK DIA	OAL	Price
37-61	1/2	13/32	1/4	1-25/32	\$15.36
37-62	3/4	1/2	1/2	2-1/8	\$35.40
37-63	1	27/32	1/2	2-27/32	\$42.84

37-50
37-60



37-70

ONSRUD

Double Flute - Carbide Tipped Folding Tool for Dibond/Alucobond

Designed for cutting aluminum/plastic sandwich materials with 90° angle and flat bottom.

Usage Aluminum/plastic sandwich materials

Material ▲

Part Number	Cutting DIA	Flute LGTH	SHK DIA	OAL	Price
37-71	1/2	3/8	1/4	2	\$51.92
37-72	1/2	3/8	1/2	2	\$55.68

90° angle and .090 flat for folding material



37-80

Double Flute - Carbide Tipped Lettering Bits

Designed for V grooving or beveling edges of parts. The tools are designed to cut a wide variety of wood products and produce a clean edge.

Usage Wood

Material ■ ● ■

Part Number	Cutting DIA	Flute LGTH	SHK DIA	OAL	ANGLE	Price
37-82	1	0.856	1/2	3-1/2	60°	\$26.36
37-87	1-1/2	0.750	1/2	3	90°	\$30.76
37-92	2	0.577	1/2	3	120°	\$30.76
37-97	2	0.363	1/2	2-5/8	140°	\$30.76



ONSRUD

40-50

Double Flute - Carbide Tipped Round & Rout



Designed to put a radius on the edge and dress the stock. They will provide a smooth finish.

Usage Natural wood, wood composites, plastic and solid surface

Material



Part Number	Cutting DIA	Sm Cutting DIA	Flute LGTH	SHK DIA	OAL	RAD	Material Thickness	Price
40-50	1	1/2	.938	1/2	3-3/16	3/16	3/4	\$63.00
40-52	1-1/8	1/2	.937	1/2	3-3/16	1/4	3/4	\$63.88
40-54	1-3/8	1/2	.938	1/2	3-3/16	3/8	3/4	\$66.56
40-55	1-3/8	1/2	1.437	1/2	3-11/16	3/8	1-3/8	\$66.56

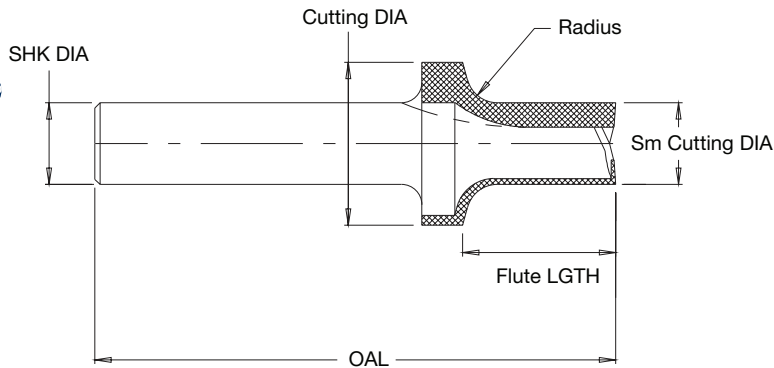

Single Flute - High Speed Steel Upcut Spiral

Designed for routing applications where speed and chip removal are primary considerations. They are also recommended when grooving, slotting or blind routing.

Usage Natural wood, sheet and stacked aluminum

Material SW HW A



Part Number	Cutting DIA	Flute LGTH	SHK DIA	OAL	Price
40-001	1/8	3/8	1/4	2-5/8	\$11.56
40-003	3/16	5/8	1/4	2-7/8	\$10.32
40-005	1/4	5/8	1/4	2-3/4	\$8.48
40-009	1/4	3/4	1/2	3-1/4	\$15.64
40-021	5/16	3/4	1/2	3-1/4	\$16.24
40-023	5/16	1	1/2	3-1/2	\$17.72
40-025	21/64	3/4	1/2	3-1/4	\$17.08
40-033	3/8	1	1/2	3-1/2	\$19.20

40-000



HELIX ANGLE = 19° - 32° Shear

Single Flute - High Speed Steel Downcut Spiral

Designed for through cut routing operations where speed is the primary concern and fixturing is such that both chips and material are better off forced down.

Usage Sheet aluminum

Material A

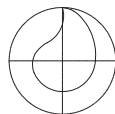

Part Number	Cutting DIA	Flute LGTH	SHK DIA	OAL	Price
40-008	1/4	3/4	1/4	2 3/4	\$9.25
40-012	1/4	1	1/4	3	\$10.56

40-000



HELIX ANGLE = 19° - 32° Shear

40-100



ONSRUD

Double Flute - High Speed Steel Upcut Spiral

Provides a smoother finish when grooving, slotting or blind routing than do single flute tools. Recommended when fixturing requires upward chip removal.

Usage Natural wood sheet, block & plate aluminum

Material SW HW A



Part Number	Cutting DIA	Flute LGTH	SHK DIA	OAL	Price
40-101	1/8	3/8	1/4	2-5/8	\$8.40
40-103	3/16	5/8	1/4	2-7/8	\$9.08
40-153	7/32	7/8	1/4	3	\$11.24
40-105	1/4	5/8	1/4	2-3/4	\$7.92
40-107	1/4	3/4	1/4	2-3/4	\$6.80

Part Number	Cutting DIA	Flute LGTH	SHK DIA	OAL	Price
40-107	1/4	3/4	1/4	2-3/4	\$6.80
40-109	1/4	3/4	1/2	3-1/4	\$16.24
40-111*	1/4	1	1/4	3	\$8.48
40-121	5/16	3/4	1/2	3-1/4	\$14.40
40-117	5/16	3/4	3/8	3	\$14.60
40-115	5/16	1	5/16	3	\$14.36
40-123	5/16	1	1/2	3-1/2	\$20.68
40-131*	3/8	1	3/8	3	\$12.88
40-133	3/8	1	1/2	3-1/2	\$15.36
40-135	3/8	1-1/4	1/2	3-3/4	\$20.40
40-137	1/2	1-1/4	1/2	3-1/4	\$17.48
40-139	1/2	1-1/2	1/2	3-1/2	\$20.44
40-141	3/4	1-1/4	1/2	3-1/4	\$45.32

HELIX ANGLE ~ 19° - 32° Shear

* These tools are designed and toleranced for air routers with guide bushings.

40-100



Double Flute - High Speed Steel Downcut Spiral

Provides a smoother finish than single flute in trimming and sizing. Recommended when chip flow should be directed down to protect the finish on the top of the material being cut.

Usage Natural wood sheet & aluminum extrusions

Material SW HW A



HELIX ANGLE ~ 19° - 32° Shear

* These tools are designed and toleranced for air routers with guide bushings.

Part Number	Cutting DIA	Flute LGTH	SHK DIA	OAL	Price
40-102	1/8	5/16	1/4	2-5/8	\$8.40
40-104	3/16	5/8	1/4	2-7/8	\$9.08
40-106	1/4	5/8	1/4	2-3/4	\$7.88
40-108	1/4	3/4	1/4	2-3/4	\$7.40
40-110	1/4	3/4	1/2	3-1/4	\$15.32
40-112*	1/4	1	1/4	3	\$8.48
40-158*	1/4	1	1/4	3-1/4	\$10.36
40-122	5/16	3/4	1/2	3-1/4	\$16.40
40-116	5/16	1	5/16	3	\$10.16
40-124	5/16	1	1/2	3-1/2	\$17.48
40-134	3/8	1	1/2	3-1/2	\$17.48
40-138	1/2	1-1/4	1/2	3-1/4	\$17.96
40-140	1/2	1-1/2	1/2	3-1/2	\$19.48
40-142	3/4	1-1/4	1/2	3-1/4	\$45.32

40-550



Four Flute - High Speed Steel Upcut Spiral Foam Cutters

Designed to cut thick foam with upward chipflow.

Usage Foam

Material FP



Part Number	Cutting DIA	Flute LGTH	SHK DIA	OAL	Price
40-562	1/2	3-5/8	1/2	6	\$47.28
40-564	1/2	4-1/8	1/2	6-1/2	\$53.44

HELIX ANGLE ~ 25°

ONSRUD

Double Flute - Carbide Tipped Corner Round

Quarter round profile tools feature up shear geometry for better finishes.

Usage Natural wood, wood composites and solid surface

Material SW HW CW SSP

Part Number	Radius	Cutting DIA	Flute LGTH	SHK DIA	OAL	Price
42-10	1/8	3/4	3/8	1/4	2-1/8	\$30.72
42-03	5/32	13/16	15/32	1/4	2-3/32	\$33.20
42-01	3/16	7/8	1/2	1/4	2	\$30.04
42-02	1/4	1	7/16	1/4	1-29/32	\$30.80
42-04	5/16	1-1/8	9/16	1/4	2-1/4	\$32.84
42-05	3/8	1-1/4	5/8	1/4	2-1/32	\$32.60
42-06	1/2	1-1/2	3/4	1/4	2-5/32	\$34.92
42-07	1/2	1-1/2	3/4	1/2	2-11/16	\$41.16
42-08	3/4	2	1-1/32	1/2	3	\$59.08



Double Flute - Carbide Tipped MDF Panel Tools

These cutters can create 12 cabinet combinations by combining different stile and panel cutters to get the desired shape in MDF material.

Usage MDF

Material CW

Part Number	Cutting DIA	SHK DIA	OAL	Description	Price
47-02	7/8	1/2	2-1/2	Bead Profile - Stile Bits	\$47.80
47-04	1-1/4	1/2	2-1/2	Traditional Profile - Stile Bits	\$52.00
47-06	1-1/4	1/2	2-1/2	Ogee Profile - Stile Bits	\$52.00
47-08	1-1/4	1/2	2-1/2	Straight Profile - Stile Bits	\$52.00
47-10	1-1/2	1/2	2-1/2	Cove Profile - Panel Bits	\$74.88
47-12	1-1/2	1/2	2-1/2	Straight Profile - Panel Bits	\$74.88
47-14	1-1/2	1/2	2-1/2	Ogee Profile - Panel Bits	\$74.88

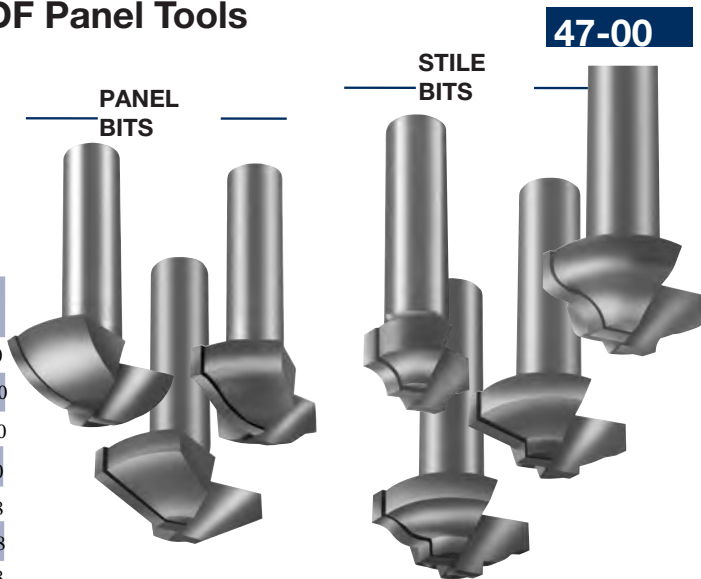

TOOL COMBINATIONS

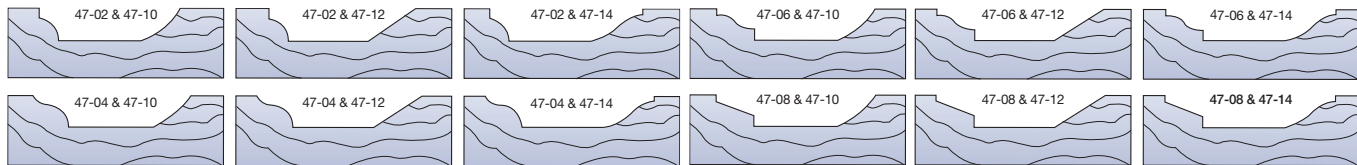

ONSRUD

Single Flute - Carbide Tipped Straight

Designed for general usage where faster feed rates, free cutting action and long tool life are essential.

Usage Natural wood, wood composites, composite plastic and foam

Material HW CW CP FP

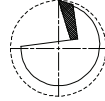

Part Number	Cutting DIA	Flute LGTH	SHK DIA	OAL	Price
48-005	1/4	7/8	1/4	2-3/8	\$10.64
48-007	1/4	1	1/4	2-3/8	\$12.40
48-079*	1/4	1	1/4	3-1/4	\$13.44
48-056	3/8	1-1/4	1/2	2-3/4	\$17.12
48-069	1/2	1-1/2	1/2	3	\$16.68

* These tools are designed and toleranced for Air Routers with guide bushings.

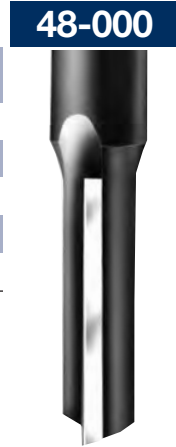

Double Flute - Carbide Tipped Straight

Designed for general usage where superior balance and vibration free cutting provides a smoother finish along with long tool life.

Usage Natural wood, wood composites, composite plastic and foam

Material HW CW CP FP

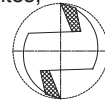

Part Number	Cutting DIA	Flute LGTH	SHK DIA	OAL	Price
48-008+	1/8	5/16	1/4	2	\$16.72
48-004	1/4	5/8	1/4	2-1/8	\$15.20
48-006	1/4	7/8	1/4	2-3/8	\$14.24
48-018	1/4	7/8	1/2	2-1/2	\$18.52
48-106	1/4	1	1/4	2-3/8	\$14.40
48-179*	1/4	1	1/4	3-1/4	\$15.44
48-017	5/16	3/4	1/2	2-1/4	\$19.28
48-010	5/16	1	1/4	2-1/2	\$15.96
48-012	3/8	3/4	1/4	2-1/4	\$19.96
48-036*	3/8	1	3/8	2-1/2	\$16.00
48-057	3/8	1	1/2	2-1/2	\$18.44
48-058*	3/8	1-1/4	3/8	3	\$18.36
48-158	3/8	1-1/4	1/2	2-3/4	\$20.36
48-014	1/2	3/4	1/4	2-1/8	\$17.00
48-072	1/2	1	1/2	2-1/2	\$19.72
48-076	1/2	1-1/4	1/2	2-3/4	\$19.64
48-080	1/2	1-1/2	1/2	3	\$21.56
48-081	1/2	2	1/2	4	\$26.72
48-183	1/2	2-1/2	1/2	4-1/2	\$33.44
48-015	5/8	1	1/4	2-1/4	\$18.08
48-086	5/8	1-1/4	1/2	2-3/4	\$22.40
48-016	3/4	1	1/4	2-1/4	\$20.20
48-088	3/4	1-1/4	1/2	3	\$22.68
48-215	3/4	2	3/4	4	\$39.72
48-096	7/8	1-1/4	1/2	2-3/4	\$30.12
48-100	1	1-1/4	1/2	2-3/4	\$31.88

+ Solid Carbide

*These tools are designed and toleranced for Air Routers with guide bushings.



49-000



ONSRUD

Double Flute - High Speed Steel Downcut

These double flute downcuts with a drill type point were developed initially as "Aircraft Throwaway" tools. They have many uses in trimming and routing primarily with hand held routers.

Usage Aluminum

Material A

Part Number	Cutting DIA	Flute LGTH	SHK DIA	OAL	Price
49-005	1/4	9/16	1/4	2 1/2	\$6.52
49-001	1/4	9/16	1/4	2 3/4	\$6.52
49-007	1/4	9/16	1/4	3 1/4	\$6.92
49-003	3/8	3/4	3/8	2 1/2	\$12.00

THESE TOOLS ARE DESIGNED AND TOLERANCED FOR AIR ROUTERS WITH GUIDE BUSHINGS, + .000 - .006
HELIX ANGLE = 24°

52-000



Double Flute - Solid Carbide Upcut Spiral

Designed as a general purpose spiral with several times the life of their high speed steel counterparts. They are used when upward chip flow is preferred.

Usage Fiberglass, phenolic, acetal, solid surface and aluminum slab

Material CP A SSP

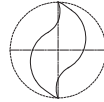

Part Number	Cutting DIA	Flute LGTH	SHK DIA	OAL	Price
52-040	1/8	1/2	1/4	2	\$22.52
52-050	5/32	9/16	1/4	2	\$22.52
52-060	3/16	5/8	1/4	2	\$22.52
52-080	1/4	3/4	1/4	2-1/2	\$22.52
52-100	5/16	13/16	3/8	2-1/2	\$38.28
52-120	3/8	7/8	3/8	2-1/2	\$38.28
52-160	1/2	1	1/2	3	\$63.88

HELIX ANGLE = 30°

52-200



Double Flute - Solid Carbide Upcut Spiral Wood Rout

Designed for routing where upward chip removal, tool rigidity, long life and high quality finish is desired.

Usage Natural wood, wood composites solid surface, and some plastic

Material SW HW CW SP

Part Number	Cutting DIA	Flute LGTH	SHK DIA	OAL	Price
52-244	1/8	1/2	1/8	2	\$20.96
52-240	1/8	1/2	1/4	2	\$19.40
52-250	5/32	5/8	1/4	2	\$19.40
52-260	3/16	3/4	1/4	2	\$19.40
52-261	3/16	3/4	1/4	2-1/2	\$21.32
52-280	1/4	7/8	1/4	2-1/2	\$21.88
52-285	1/4	1	1/4	2-1/2	\$22.68
52-287	1/4	1-1/8	1/4	3	\$25.20
52-300	5/16	1-1/8	5/16	3	\$37.52
52-310	5/16	1-1/8	1/2	3	\$62.64
52-310L	5/16	1-1/8	1/2	3	\$68.92
52-318*	3/8	1	3/8	3	\$31.32
Part Number	Cutting DIA	Flute LGTH	SHK DIA	OAL	Price
52-320	3/8	1-1/8	3/8	3	\$37.52
52-325	3/8	1-1/4	3/8	3	\$40.08
52-330	3/8	1-1/4	1/2	3	\$62.64
52-340	7/16	1	1/2	3	\$60.12
52-360	1/2	1-1/8	1/2	3	\$60.12
52-362	1/2	1-1/4	1/2	3-1/2	\$62.64
52-365	1/2	1-5/8	1/2	3-1/2	\$62.64
52-365L	1/2	1-5/8	1/2	3-1/2	\$68.88
52-367	1/2	2-1/8	1/2	4	\$68.88
52-385	5/8	2-1/8	5/8	4	\$162.84
52-395	3/4	2-1/8	3/4	4	\$194.12

HELIX ANGLE = 30°

L = Left Hand Rotation

* Special Point (Improved Bottom Finish)

ONSRUD

Double Flute - Solid Carbide Upcut Spiral Ball Nose

52-200B/BL

Designed for carving and modeling operations. Their improved tip geometry gives a superior cut compared to most ballnose endmills.

Usage Plastic, solid surface, block & plate aluminum natural wood and wood composite

Material SW HW CW SP HP A

EXTENDED LENGTH

Part Number	Cutting DIA	Flute LGTH	ERL	SHK DIA	OAL	Price
52-235BL	1/16	1/4	-	1/8	3	\$43.44
52-244BL	1/8	1/2	1-5/8	1/8	3	\$45.48
52-240BL	1/8	1/2	1-5/8	1/4	3	\$45.48
52-260BL	3/16	3/4	1-5/8	1/4	3	\$45.48
52-280BL	1/4	1	2-5/8	1/4	4	\$51.36
52-320BL	3/8	1-1/4	2-5/8	3/8	4	\$81.88
52-360BL	1/2	1-1/2	3-5/8	1/2	5	\$105.60
52-386BL	5/8	2-1/2	3-5/8	5/8	5	\$202.60
52-397BL	3/4	3	4-5/8	3/4	6	\$202.60

Part Number	Cutting DIA	Flute LGTH	SHK DIA	OAL	Price
52-235B	1/16	1/4	1/8	2	\$31.28
52-244B	1/8	1/2	1/8	2	\$33.60
52-240B	1/8	1/2	1/4	2	\$33.60
52-260B	3/16	3/4	1/4	2	\$33.60
52-280B	1/4	7/8	1/4	2-1/2	\$33.60
52-320B	3/8	1-1/8	3/8	3	\$53.24
52-360B	1/2	1-1/8	1/2	3	\$81.88
52-386B	5/8	2-1/4	5/8	4	\$185.16
52-397B	3/4	2-1/2	3/4	5	\$202.60



METRIC

Part Number	Cutting DIA	Flute LGTH	SHK DIA	OAL	Price
52-240BM	3mm	12mm	6mm	50mm	\$29.36
52-280BM	6mm	22mm	6mm	64mm	\$29.68
52-320BM	10mm	29mm	10mm	76mm	\$53.88
52-360BM	12mm	29mm	12mm	76mm	\$77.36

Double Flute - Solid Carbide Upcut Spiral Wood Rout

Designed for routing where upward chip removal, tool rigidity, long life and high quality finish is desired.

Usage Natural wood, wood composites, plastic and solid surface

Material SW HW CW SP

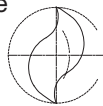

METRIC

Part Number	Cutting DIA	Flute LGTH	SHK DIA	OAL	Price
52-410	4mm	16mm	6mm	64mm	\$19.44
52-411	5mm	20mm	6mm	64mm	\$19.44
52-412	6mm	25mm	6mm	64mm	\$21.84
52-414	8mm	25mm	8mm	64mm	\$40.68
52-416	10mm	35mm	10mm	76mm	\$46.92
52-418	12mm	35mm	12mm	76mm	\$62.64

HELIX ANGLE ≈ 30°

52-400



Double Flute - Solid Carbide Upcut Foam Cutters

Foam cutters for thick material with upward chip flow.

Usage Foam

Material FP

HELIX ANGLE ≈ 25°

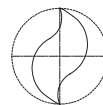

Part Number	Cutting DIA	Flute LGTH	SHK DIA	OAL	Price
52-554	1/8	1-1/8	1/4	2-1/2	\$40.56
52-558	3/16	1-1/8	3/16	3	\$40.56
52-560	3/16	1-5/8	3/16	4	\$43.92
52-564	1/4	2-1/4	1/4	4	\$46.28
52-570	5/16	3-1/8	5/16	6	\$52.04
52-574	3/8	3-1/2	3/8	6	\$57.88

52-550



ONSRUD

52-600

Double Flute - Solid Carbide Upcut Spiral O Flute



Low helix geometry designed to cut soft and hard plastic with a smooth finish and upward chip flow.

Usage Soft and hard plastic, acrylic, nylon, ABS, PE, acetal, PET, HDPE, UHMW, polycarbonate and solid surface

Material **SP** **HP** **SSP**

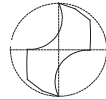

Part Number	Cutting DIA	Flute LGTH	SHK DIA	OAL	Price
52-622	1/4	3/8	1/4	2-1/2	\$20.32
52-624	1/4	3/4	1/4	2-1/2	\$21.72
52-638	3/8	1	3/8	3	\$42.12
52-650	1/2	1-1/8	1/2	3-1/2	\$73.16
52-652	1/2	1-5/8	1/2	3-1/2	\$86.80
52-655	1/2	2-1/8	1/2	4-1/2	\$109.92
52-660	5/8	2-1/8	5/8	5	\$156.16
52-664	3/4	3-1/8	3/4	6	\$223.32

HELIX ANGLE = 11°

52-700

Double Flute - Solid Carbide Upcut Spiral O Flute



High helix geometry designed to cut soft plastic with a smooth finish and upward chip flow. Special point geometry for improved bottom finish.

Usage Soft plastic, extruded acrylic, nylon, ABS, PE, acetal, PET, HDPE, UHMW, polycarbonate, solid surface and foam.

Material **SP** **SSP** **FP**

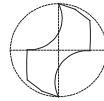

Part Number	Cutting DIA	Flute LGTH	SHK DIA	OAL	Price
52-703	1/8	1/2	1/4	2	\$34.96
52-707	1/4	7/8	1/4	3	\$40.92
52-708	3/16	3/8	3/16	2-1/2	\$37.40
52-700	1/4	1-1/4	1/4	3	\$42.84
52-709	3/8	1	3/8	3	\$64.40
52-710	3/16	5/8	1/4	2-1/2	\$38.52
52-701	3/8	1-1/2	3/8	4	\$73.72
52-702	1/2	1-1/4	1/2	4	\$79.36
52-704	1/2	1-3/4	1/2	4	\$87.36
52-706	1/2	2-1/8	1/2	4	\$103.28
52-712	5/8	1-3/4	5/8	5	\$153.12
52-714	5/8	2-1/4	5/8	5	\$158.84
52-726	3/4	1-3/4	3/4	5	\$169.92
52-724	3/4	2-1/2	3/4	5	\$184.84
52-728	3/4	4	3/4	6-1/2	\$285.40
52-734	1	4	1	6-1/2	\$509.32

HELIX ANGLE = 22°

METRIC

Part Number	Cutting DIA	Flute LGTH	SHK DIA	OAL	Price
52-742	12mm	35mm	12mm	100mm	\$94.96
52-744	12mm	45mm	12mm	100mm	\$100.40
52-746	12mm	55mm	12mm	100mm	\$107.24
52-752	16mm	45mm	16mm	120mm	\$139.60
52-754	16mm	55mm	16mm	120mm	\$142.64
52-764	20mm	65mm	20mm	125mm	\$190.48

Double Flute - Solid Carbide Upcut Extreme Heavy Duty Standard

Developed for demanding applications where upward chip removal, tool rigidity and long life are essential to success.

Usage Natural wood and wood composites

Material **SW** **HW** **CW**

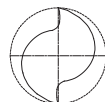

Part Number	Cutting DIA	Flute LGTH	SHK DIA	OAL	Price
52-910	1/4	7/8	1/4	2-1/2	\$18.48
52-914	1/4	1-1/4	1/4	3	\$33.60
52-923	3/8	1-1/8	3/8	3	\$35.88
52-936	1/2	1-1/4	1/2	3	\$46.28

HELIX ANGLE = 30°

52-900



ONSRUD

Three Flute - Solid Carbide Straight

Designed for routing extremely hard materials or when spindle RPM is lower than normal for routing.

Part Number	Cutting DIA	Flute LGTH	SHK DIA	OAL	Price
53-080	1/4	3/4	1/4	2-1/2	\$26.32

Usage Composites

Material 

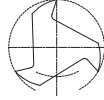

53-000



Three & Four Flute - Solid Carbide Spiral for Glass-Reinforced Plastic (Coated)

Updated line of three and four flute tools for machining glass-reinforced plastic. Geometry has been optimized to shear the glass fibers while creating a chip which removes heat from the cut to avoid melting of the material. Tools are coated to withstand the abrasive characteristics inherent to glass-reinforced plastic (GRP).

Usage Fiberglass and Composites

Material 

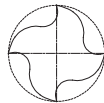

NEW

54-20



UPCUT

Part Number	Cutting DIA	Flute LGTH	SHK DIA	OAL	FLUTES	Price
54-205	1/8	1/2	1/4	2-1/2	3	\$56.96
54-210	3/16	5/8	1/4	2-1/2	3	\$58.80
54-220	1/4	3/4	1/4	2-1/2	4	\$64.28
54-230	3/8	1-1/8	3/8	3	4	\$91.84
54-240	1/2	1-1/8	1/2	3-1/2	4	\$119.40

METRIC UPCUT

Part Number	Cutting DIA	Flute LGTH	SHK DIA	OAL	FLUTES	Price
54-260	6mm	19mm	6mm	76mm	4	\$64.28
54-266	8mm	22mm	8mm	76mm	4	\$88.56
54-270	10mm	25mm	10mm	76mm	4	\$98.40
54-276	12mm	25mm	12mm	76mm	4	\$119.40

DOWNCUT

Part Number	Cutting DIA	Flute LGTH	SHK DIA	OAL	FLUTES	Price
54-206	1/8	1/2	1/4	2-1/2	3	\$56.96
54-211	3/16	5/8	1/4	2-1/2	3	\$58.80
54-221	1/4	3/4	1/4	2-1/2	4	\$64.28
54-231	3/8	1-1/8	3/8	3	4	\$91.84
54-241	1/2	1-1/8	1/2	3-1/2	4	\$119.40

METRIC DOWNCUT

Part Number	Cutting DIA	Flute LGTH	SHK DIA	OAL	FLUTES	Price
54-261	6mm	19mm	6mm	76mm	4	\$64.28
54-267	8mm	22mm	8mm	76mm	4	\$88.56
54-271	10mm	25mm	10mm	76mm	4	\$98.40
54-277	12mm	25mm	12mm	76mm	4	\$119.40

56-000

Double Flute - Solid Carbide Straight



Designed to rout composite plastic.

Usage Composite plastic

Material    

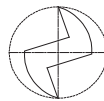

* These tools are designed and toleranced for air routers with guide bushings.

Part Number	Cutting DIA	Flute LGTH	SHK DIA	OAL	Price
56-040	1/8	1/2	1/4	2	\$22.52
56-060	3/16	5/8	1/4	2	\$22.52
56-080	1/4	3/4	1/4	2-1/2	\$22.52
56-084*	1/4	3/4	1/4	3-1/4	\$26.32
56-100	5/16	13/16	3/8	2-1/2	\$38.28
56-160	1/2	1	1/2	3	\$63.88

ONSRUD Double Flute - Solid Carbide Straight

56-000P



Designed specifically to rout harder, more rigid plastics.

Usage Foam, fiberglass, phenolic, acrylic, nylon, PVC, ABS, acetal and solid surface

Material HP CP SSF FP

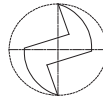

Part Number	Cutting DIA	Flute LGTH	SHK DIA	OAL	Price
56-041	1/8	1/4	1/4	2	\$21.52
56-061	3/16	3/8	1/4	2	\$21.52
56-062	3/16	5/8	1/4	2	\$22.52
56-062L	3/16	5/8	1/4	2	\$24.80
56-063*	3/16	5/8	1/4	4	\$42.04
56-081	1/4	3/8	1/4	2-1/2	\$22.64
56-082	1/4	3/4	1/4	2-1/2	\$23.68
56-082L	1/4	3/4	1/4	2-1/2	\$26.28
56-086*	1/4	1-1/4	1/4	4	\$44.32
56-121	3/8	5/8	3/8	2-1/2	\$43.16
56-122	3/8	7/8	3/8	2-1/2	\$44.64
56-122L	3/8	7/8	3/8	2-1/2	\$49.28
56-124*	3/8	1-5/8	3/8	6	\$68.64
56-162	1/2	1	1/2	3	\$70.28
56-162L	1/2	1	1/2	3	\$77.32
56-164*	1/2	2-1/8	1/2	6	\$95.92

* These tools are designed and toleranced for air routers with guide bushings.
L = Left Hand Rotation

56-200

Double Flute - Solid Carbide Straight Wood Rout



Provides a superior finish in a variety of wood materials and optimum cutter life.

Usage Natural wood and wood composites

Material SW HW CW

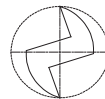

Part Number	Cutting DIA	Flute LGTH	SHK DIA	OAL	Price
56-240	1/8	1/2	1/4	2	\$19.80
56-250	5/32	5/8	1/4	2	\$19.80
56-260	3/16	3/4	1/4	2	\$19.80
56-270	7/32	3/4	1/4	2-1/2	\$20.00
56-280	1/4	7/8	1/4	2-1/2	\$22.52
56-285	1/4	1	1/4	2-1/2	\$23.08
56-287	1/4	1-1/8	1/4	3	\$25.72
56-300	5/16	1-1/8	5/16	3	\$38.28
56-310	5/16	1-1/8	1/2	3	\$63.88
56-320	3/8	1-1/8	3/8	3	\$38.28
56-330	3/8	1-1/4	1/2	3	\$63.88
56-360	1/2	1-1/8	1/2	3	\$61.28
56-365	1/2	1-5/8	1/2	3-1/2	\$63.88
56-390	3/4	1-5/8	3/4	4	\$191.60

ONSRUD

Double Flute - Solid Carbide Straight O Flute

Designed with free cutting O flute geometry along with a double flute design for smooth finish.

Usage Polycarbonate, ABS, HIPS, HDPE, PET, acrylic, polystyrene, polypropylene, PE, PVC, acetal, UHMW

Material  

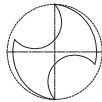

METRIC

Part Number	Cutting DIA	Flute LGTH	SHK DIA	OAL	Price
56-430	4 mm	16 mm	6 mm	64 mm	\$19.40
56-431	5 mm	20 mm	6 mm	64 mm	\$19.40
56-432	6 mm	25 mm	6 mm	64 mm	\$21.76
56-434	8 mm	25 mm	8 mm	76 mm	\$40.60
56-436	10 mm	35 mm	10 mm	88 mm	\$46.68
56-438	12 mm	35 mm	12 mm	88 mm	\$62.32

56-430



Double Flute - Solid Carbide Straight

Designed specifically to rout harder, more rigid plastics

Usage Phenolic, acrylic, nylon, PVC, ABS, acetal and solid surface

Material   

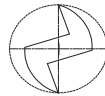

METRIC

Part Number	Cutting DIA	Flute LGTH	SHK DIA	OAL	Price
56-450	4 mm	16 mm	6 mm	64 mm	\$30.40
56-451	5 mm	20 mm	6 mm	64 mm	\$30.40
56-452	6 mm	25 mm	6 mm	64 mm	\$32.52
56-454	8 mm	25 mm	8 mm	76 mm	\$36.60
56-456	10 mm	35 mm	10 mm	88 mm	\$76.80
56-458	12 mm	35 mm	12 mm	88 mm	\$83.48

56-450



Double Flute - Solid Carbide O Flute Straight

Designed with free cutting O flute geometry along with a double flute design for smooth finish.

Usage Polycarbonate, ABS, HIPS, HDPE, PET, acrylic, polystyrene, polypropylene, PE, PVC, acetal, UHMW

Material  

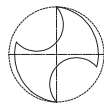

Part Number	Cutting DIA	Flute LGTH	SHK DIA	OAL	Price
56-610	1/8	5/16	1/4	2	\$20.84
56-612	1/8	1/2	1/4	2	\$21.72
56-614	1/8	5/8	1/4	4	\$31.04
56-616	3/16	3/8	1/4	2	\$20.84
56-618	3/16	5/8	1/4	2	\$21.72
56-620	3/16	1	1/4	4	\$31.04
56-624	1/4	3/8	1/4	2-1/2	\$21.72
56-625	1/4	1	1/4	2-1/2	\$23.84
56-625L	1/4	1	1/4	2-1/2	\$26.28
56-626	1/4	1	1/4	3-1/4	\$26.28
56-628	1/4	1-1/4	1/4	4	\$43.36
56-638	3/8	7/8	3/8	2-1/2	\$43.96
56-639	3/8	1	3/8	4	\$53.56
56-650	1/2	1	1/2	3	\$68.36
56-652	1/2	1	1/2	4	\$72.44
56-654	1/2	1-3/4	1/2	4	\$84.60
56-655	1/2	2-1/8	1/2	6	\$95.56

56-600



L = Left Hand Rotation

ONSRUD

57-000 Double Flute - Solid Carbide Downcut Spiral



Designed as a general purpose spiral with several times the life of their high speed counterparts. They are used when a downward chipflow action is preferred.

Usage Aluminum and composite plastic

Material CP A

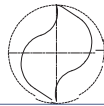

Part Number	Cutting DIA	Flute LGTH	SHK DIA	OAL	Price
57-040	1/8	1/2	1/4	2	\$22.52
57-060	3/16	5/8	1/4	2	\$22.52
57-080	1/4	3/4	1/4	2-1/2	\$22.52
57-120	3/8	7/8	3/8	2-1/2	\$38.28
57-160	1/2	1	1/2	3	\$63.88

HELIX ANGLE = 30°

57-200 Double Flute - Solid Carbide Downcut Spiral Wood Rout



Designed for routing where downward chip removal, tool rigidity, long life, and high quality finish is desired.

Usage Natural wood and wood composites

Material SW HW CW

Part Number	Cutting DIA	Flute LGTH	SHK DIA	OAL	Price	Part Number	Cutting DIA	Flute LGTH	SHK DIA	OAL	Price
57-244	1/8	1/2	1/8	2	\$20.96	57-320	3/8	1-1/8	3/8	3	\$37.52
57-240	1/8	1/2	1/4	2	\$19.40	57-325	3/8	1-1/4	3/8	3	\$40.08
57-240L	1/8	1/2	1/4	2	\$21.40	57-330	3/8	1-1/4	1/2	3	\$62.64
57-251	5/32	1/2	1/4	2-1/2	\$21.32	57-340	7/16	1	1/2	3	\$60.12
57-250	5/32	5/8	1/4	2	\$19.40	57-360	1/2	1-1/8	1/2	3	\$60.12
57-260	3/16	3/4	1/4	2	\$19.40	57-362	1/2	1-1/4	1/2	3-1/2	\$62.64
57-261	3/16	3/4	1/4	2-1/2	\$21.32	57-365	1/2	1-5/8	1/2	3-1/2	\$62.64
57-270	7/32	3/4	1/4	2-1/2	\$19.64	57-365L	1/2	1-5/8	1/2	3-1/2	\$68.88
57-280	1/4	7/8	1/4	2-1/2	\$21.88	57-367	1/2	2-1/8	1/2	4	\$68.88
57-285	1/4	1	1/4	2-1/2	\$22.68	57-370	17/32	1-1/8	1/2	3	\$150.32
57-285L	1/4	1	1/4	2-1/2	\$24.92	57-380	5/8	1-5/8	5/8	3-1/2	\$150.32
57-287	1/4	1-1/8	1/4	3	\$25.20	57-385	5/8	2-1/8	5/8	4	\$162.84
57-290	9/32	1	5/16	2-1/2	\$37.52	57-390	3/4	1-5/8	3/4	4	\$187.76
57-300	5/16	1-1/8	5/16	3	\$37.52	57-395	3/4	2-1/8	3/4	4	\$194.12
57-310	5/16	1-1/8	1/2	3	\$62.64	57-395L	3/4	2-1/8	3/4	4	\$213.60
57-310L	5/16	1-1/8	1/2	3	\$68.88						
57-318*	3/8	1	3/8	3	\$31.32						

HELIX ANGLE = 30°

L = Left Hand Rotation

* Special Point (Improved Bottom Finish)

57-200M Double Flute - Marathon Wood Rout Downcut (Coated)



The longest running downcut in the industry due to advancements in geometry and the addition of a unique Onsrud coating.

Usage Wood composites

Material CW

NEW

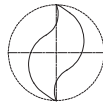

Part Number	Cutting DIA	Flute LGTH	SHK DIA	OAL	Price
57-278MD	1/4	3/8	1/4	2-1/2	\$34.44
57-279MD	1/4	5/8	1/4	2-1/2	\$44.68
57-317MD	3/8	7/8	3/8	3	\$54.92
57-359MD	1/2	7/8	1/2	3	\$78.72

ONSRUD

Double Flute - Solid Carbide Downcut Spiral Wood Rout

Designed for routing where downward chip removal, tool rigidity, long life, and high quality finish is desired.

Usage Natural wood and wood composites

Material SW HW CW

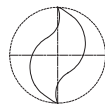

METRIC

Part Number	Cutting DIA	Flute LGTH	SHK DIA	OAL	Price
57-410	4 mm	16 mm	6 mm	64 mm	\$19.44
57-411	5 mm	20 mm	6 mm	64 mm	\$19.44
57-412	6 mm	25 mm	6 mm	64 mm	\$21.84
57-414	8 mm	25 mm	8 mm	64 mm	\$40.68
57-416	10 mm	35 mm	10 mm	76 mm	\$46.92

HELIX ANGLE ≈ 30°

57-400



Double Flute - Solid Carbide Downcut Spiral O Flute

Designed to cut plastic with a smooth finish and downward chip flow.

Usage Acrylic, nylon, ABS, PE, acetal, PET, HDPE, UHMW, polycarbonate and solid surface

Material SP HP SSP

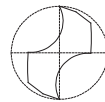

METRIC

Part Number	Cutting DIA	Flute LGTH	SHK DIA	OAL	Price
57-623	1/4	3/8	1/4	2-1/2	\$20.76
57-625	1/4	3/4	1/4	2-1/2	\$22.20
57-637	3/8	1	3/8	3	\$42.96
57-651	1/2	1-1/8	1/2	3-1/2	\$74.60

HELIX ANGLE ≈ 10-11°

57-600



Double Flute - Solid Carbide Downcut Extreme Heavy Duty Standard

Designed for routing where extreme loads are placed upon the cutting tools and when extra part hold down is required.

Usage Natural wood and wood composites

Material SW HW CW



Part Number	Cutting DIA	Flute LGTH	SHK DIA	OAL	Price
57-910	1/4	7/8	1/4	2-1/2	\$18.48
57-921	3/8	7/8	3/8	3	\$34.08
57-923	3/8	1-1/8	3/8	3	\$35.88
57-924	3/8	1-1/4	3/8	3	\$37.04
57-936	1/2	1-1/4	1/2	3	\$46.28
57-940	1/2	1-5/8	1/2	3-1/2	\$62.52

HELIX ANGLE ≈ 30°

57-900



ONSRUD

Three Flute - Solid Carbide High Helix Hogger

60-000



Designed with unique scalloped cutting edge design for extremely fast machining and roughing. Faster chip removal with upcuts. Better hold down with downcuts.

Usage Natural wood & wood composites, hard & soft plastic and plastic composites

Material SW HW CW

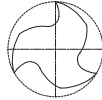

UPCUT

Part Number	Cutting DIA	Flute LGTH	SHK DIA	OAL	Price
60-001	3/8	1-1/8	3/8	3-1/2	\$74.36
60-005	1/2	1-1/8	1/2	3-1/2	\$101.84
60-007	1/2	1-5/8	1/2	4	\$104.12
60-009	5/8	1-5/8	5/8	4	\$207.76
60-011	5/8	2-1/8	5/8	5	\$219.96
60-017	3/4	1-5/8	3/4	4	\$250.52
60-019	3/4	2-1/8	3/4	5	\$268.76

HELIX ANGLE ≈ 30°

DOWNCUT

Part Number	Cutting DIA	Flute LGTH	SHK DIA	OAL	Price
60-002	3/8	1-1/8	3/8	3-1/2	\$74.36
60-006	1/2	1-1/8	1/2	3-1/2	\$101.84
60-008	1/2	1-5/8	1/2	4	\$104.12
60-012	5/8	2-1/8	5/8	5	\$219.96
60-018	3/4	1-5/8	3/4	4	\$250.52
60-020	3/4	2-1/8	3/4	5	\$268.76

60-000



Three Flute - Solid Carbide Low Helix Hogger

Designed with unique scalloped cutting geometry which provides extremely fast roughing, lower horsepower requirements, longer tool life, and reduced chipping in solid wood materials.

Usage Natural wood & wood composites, hard & soft plastic and plastic composites

Material SW HW CW

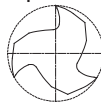

UPCUT

Part Number	Cutting DIA	Flute LGTH	SHK DIA	OAL	Price
60-037	3/8	1-1/8	3/8	3-1/2	\$77.08
60-053	1/2	1-1/8	1/2	3-1/2	\$104.92
60-051	1/2	1-5/8	1/2	4	\$107.56
60-061	5/8	2-1/8	5/8	5	\$225.44
60-073	3/4	1-5/8	3/4	4	\$256.12
60-071	3/4	2-1/8	3/4	5	\$275.52

HELIX ANGLE ≈ 10°

DOWNCUT

Part Number	Cutting DIA	Flute LGTH	SHK DIA	OAL	Price
60-038	3/8	1-1/8	3/8	3-1/2	\$77.08
60-054	1/2	1-1/8	1/2	3-1/2	\$104.92
60-052	1/2	1-5/8	1/2	4	\$107.56
60-074	3/4	1-5/8	3/4	5	\$256.76
60-072	3/4	2-1/8	3/4	5	\$275.52

ONSRUD

Three Flute - Solid Carbide Upcut Lock Mortise

The scalloped upcut cutting edge design and extra spinback provide fast material removal in deep cuts for horizontal and vertical lock mortise routing.

Usage Natural wood and wood composites

Material **SW** **HW** **CW** **MT**

Part Number	Cutting DIA	Flute LGTH	Max DOC	SHK DIA	OAL	Price
60-090	5/8	2	4-1/2	5/8	6-1/2	\$359.48

HELIX ANGLE = 30°

METRIC

Part Number	Cutting DIA	Flute LGTH	Max DOC	SHK DIA	OAL	Price
60-091	16 mm	50 mm	114 mm	16 mm	170 mm	\$516.00

HELIX ANGLE = 30°

60-090



Double & Three Flute - Marathon Compression Spiral (Coated)

The LMT Onsrud Marathon is the longest running compression tool due to advancements in cutting geometry and the addition of a unique Onsrud coating. The coating is formulated to protect the cutting edge from the high temperatures generated when routing laminated and composite wood products.

Usage Double-sided laminated and Veneered Wood Composite

Material **CW**

TWO FLUTE

Part Number	Cutting DIA	Flute LGTH	Upcut Flute LGTH	SHK DIA	OAL	Price
60-123MC*	3/8	7/8	.200	3/8	3	\$74.00
60-124MC	3/8	1-1/8	.406	3/8	3	\$78.72
60-163MC*	1/2	7/8	.200	1/2	3	\$91.88
60-169MC	1/2	1-1/8	.562	1/2	3	\$93.44
60-171MC	1/2	1-3/8	.625	1/2	3-1/2	\$99.64
60-173MC*	1/2	1-3/8	.200	1/2	3-1/2	\$102.68
60-172MC	1/2	1-5/8	.750	1/2	4	\$109.88

* MORTISE COMPRESSION

THREE FLUTE

Part Number	Cutting DIA	Flute LGTH	Upcut Flute LGTH	SHK DIA	OAL	Price
60-126MC*	3/8	7/8	.200	3/8	3	\$103.76
60-177MC*	1/2	1-3/8	.200	1/2	3-1/2	\$122.12

* MORTISE COMPRESSION

60-100MC



NEW

Double Flute - Solid Carbide Chipbreaker/Finisher Compression Spiral

Part Number	Cutting DIA	Flute LGTH	Upcut Flute LGTH	SHK DIA	OAL	Price
60-123C	3/8	7/8	.188	3/8	3	\$89.24
60-124C	3/8	1-1/8	.406	3/8	3	\$87.52
60-163C*	1/2	7/8	.200	1/2	3	\$103.56
60-169C	1/2	1-1/8	.562	1/2	3	\$103.40
60-171C	1/2	1-3/8	.625	1/2	3-1/2	\$110.32
60-172C	1/2	1-5/8	.750	1/2	4	\$117.36

HELIX ANGLE = 30°

MORTISE COMPRESSION*

Designed to give the optimum edge finish of the compression spiral bits along with the increased feed rates of the chipbreaker/finisher design.

Usage Double sided laminated, veneered, natural wood and wood composites

Material **HW** **CW** **LW**

60-100C



ONSRUD

60-100MW

**Single, Double & Three Flute - Solid Carbide
Max Life Compression Spiral**



Designed for maximum life when cutting in high-wear applications. Unique geometries and carbides improve the wear characteristics of the tool under abrasive applications with superior part finish. Mortise compressions are designed with short upcut to allow mortise cut with downcut action.

Usage Double sided laminated and veneered materials

Material CW

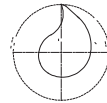

Single Flute

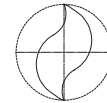

Double Flute

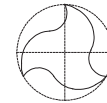

Three Flute

DOUBLE FLUTE

Part Number	Cutting DIA	Flute LGTH	Upcut Flute LGTH	SHK DIA	OAL	Price
60-113MW*	1/4	7/8	.188	1/4	2-1/2	\$51.40
60-123MW*	3/8	7/8	.188	3/8	3	\$60.12
60-124MW	3/8	1-1/8	.406	3/8	3	\$67.44
60-127MW*	3/8	1-1/8	.188	3/8	3	\$67.44
60-163MW*	1/2	7/8	.200	1/2	3	\$75.28
60-169MW	1/2	1-1/8	.562	1/2	3	\$75.84
60-171MW	1/2	1-3/8	.625	1/2	3-1/2	\$80.88
60-172MW	1/2	1-5/8	.750	1/2	4	\$86.56
60-173MW*	1/2	1-3/8	.200	1/2	3-1/2	\$83.36
60-181MW	1/2	2-1/8	1	1/2	5	\$128.32
60-186MW	5/8	2-1/4	1	5/8	5	\$218.56
60-196MW	3/4	1-7/8	.750	3/4	4	\$196.68
60-194MW	3/4	2-1/4	1	3/4	5	\$224.68

HELIX ANGLE ≈ 30°

*MORTISE COMPRESSION

SINGLE FLUTE

Part Number	Cutting DIA	Flute LGTH	Upcut Flute LGTH	SHK DIA	OAL	Price
60-102MW	1/8	3/8	.205	1/4	2-1/2	\$44.42
60-106MW	3/16	5/8	.300	1/4	2-1/2	\$45.00
60-111MW*	1/4	7/8	.175	1/4	2-1/2	\$49.60
60-120MW*	3/8	1-1/8	.200	3/8	3	\$55.12
60-167MW*	1/2	1-1/8	.200	1/2	3	\$70.76

HELIX ANGLE ≈ 30°

*MORTISE COMPRESSION

THREE FLUTE

Part Number	Cutting DIA	Flute LGTH	Upper Cut LGTH	SHK DIA	OAL	Price
60-125MW	3/8	1-1/8	.500	3/8	3	\$69.80
60-126MW*	3/8	7/8	.200	3/8	3	\$84.24
60-176MW*	1/2	7/8	.200	1/2	3	\$82.64
60-177MW*	1/2	1-3/8	.200	1/2	3-1/2	\$91.84

*MORTISE COMPRESSION

60-100DC



Double Flute - Solid Carbide Compression Spiral

The Tuff Core is an innovative line of solid carbide compression spirals that utilize unique dual grade carbide. The harder outer shell is reinforced by a tough inner core which makes the tool stronger and reduces tool breakage.

Usage Double sided laminated, and veneered materials

Material CW

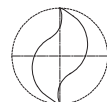

Double Flute

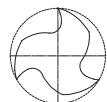

Three Flute

DOUBLE FLUTE

Part Number	Cutting DIA	Flute LGTH	Upcut Flute LGTH	SHK DIA	OAL	Price
60-123DC*	3/8	7/8	.188	3/8	3	\$78.16
60-124DC	3/8	1-1/8	.406	3/8	3	\$87.80

THREE FLUTE

Part Number	Cutting DIA	Flute LGTH	Upcut Flute LGTH	SHK DIA	OAL	Price
60-126DC*	3/8	7/8	.200	3/8	3	\$109.52

* MORTISE COMPRESSION

ONSRUD

Single, Double, Three & Four Flute - Solid Carbide Compression Spiral

Compression design for optimum edge finish on both sides of laminated materials. Designed for low speed applications.

Usage Double sided laminated, veneered, natural wood and wood composites

Material LW HW CW SW MT

60-100

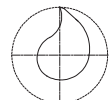

Single Flute

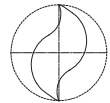

Double Flute

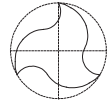

Three Flute



Four Flute

SINGLE FLUTE - SE

Part Number	Cutting DIA	Flute LGTH	Upcut Flute LGTH	SHK DIA	OAL	Price
60-110	1/4	7/8	.531	1/4	2-1/2	\$56.28
60-111*	1/4	7/8	.175	1/4	2-1/2	\$58.44
60-120	3/8	1-1/8	.500	3/8	3	\$68.88
60-160	1/2	1	.406	1/2	3	\$93.88
60-165	1/2	1-5/8	.781	1/2	3-1/2	\$100.20

HELIX ANGLE = 30° *MORTISE COMPRESSION

DOUBLE FLUTE - DE

Part Number	Cutting DIA	Flute LGTH	Upcut Flute LGTH	SHK DIA	OAL	Price
60-112	1/4	7/8	.531	1/4	2-1/2	\$64.36
60-113*	1/4	7/8	.188	1/4	2-1/2	\$62.88
60-123*	3/8	7/8	.188	3/8	3	\$82.40
60-124	3/8	1-1/8	.406	3/8	3	\$79.60
60-169	1/2	1-1/8	.562	1/2	3	\$93.88
60-172	1/2	1-5/8	.750	1/2	4	\$106.44
60-173*	1/2	1-3/8	.200	1/2	3-1/2	\$104.72
60-186	5/8	2-1/4	1	5/8	5	\$227.32

HELIX ANGLE = 30° * MORTISE COMPRESSION

THREE FLUTE - TE

Part Number	Cutting DIA	Flute LGTH	Upcut Flute LGTH	SHK DIA	OAL	Price
60-125	3/8	1-1/8	.500	3/8	3	\$95.32
60-126*	3/8	7/8	.200	3/8	3	\$95.32
60-174	1/2	1-1/8	.500	1/2	3	\$112.76
60-175	1/2	1-5/8	.750	1/2	3-1/2	\$125.40
60-176*	1/2	7/8	.200	1/2	3	\$112.76
60-177*	1/2	1-3/8	.200	1/2	3-1/2	\$125.40

HELIX ANGLE = 30° * MORTISE COMPRESSION

FOUR FLUTE - FE

Part Number	Cutting DIA	Flute LGTH	Upcut Flute LGTH	SHK DIA	OAL	Price
60-563*	1/2	7/8	.200	1/2	3	\$138.04
60-569	1/2	1-1/8	.500	1/2	3	\$142.80
60-573*	1/2	1-3/8	.200	1/2	3-1/2	\$156.36
60-572	1/2	1-5/8	.750	1/2	4	\$163.88

HELIX ANGLE = 30° * MORTISE COMPRESSION

ONSRUD

Three Flute - Solid Carbide Low Helix Finisher

Designed for perfect balance and ultra smooth finish over a wide speed range.

Usage Natural wood, plastic, composite plastic and solid surface

Material SW HW CW HP SSP



UPCUT

Part Number	Cutting DIA	Flute LGTH	SHK DIA	OAL	Price
60-239	1/4	3/8	1/4	3	\$32.60
60-241	1/4	7/8	1/4	3	\$35.64
60-243	3/8	5/8	3/8	3	\$67.12
60-245	3/8	1-1/8	3/8	3	\$69.56
60-249	1/2	1-1/8	1/2	3-1/2	\$77.40
60-253	1/2	1-5/8	1/2	4	\$85.56
60-251	1/2	2-1/8	1/2	4-1/2	\$81.52
60-269	3/4	1-5/8	3/4	4	\$188.44
60-271	3/4	2-1/8	3/4	5	\$198.60
60-277	3/4	3-1/8	3/4	6	\$224.12

HELIX ANGLE ≈ 10°

DOWNCUT

Part Number	Cutting DIA	Flute LGTH	SHK DIA	OAL	Price
60-240	1/4	3/8	1/4	3	\$32.60
60-242	1/4	7/8	1/4	3	\$35.64
60-244	3/8	5/8	3/8	3	\$67.12
60-246	3/8	1-1/8	3/8	3	\$69.56
60-250	1/2	1-1/8	1/2	3-1/2	\$77.40
60-254	1/2	1-5/8	1/2	4	\$85.56
60-252	1/2	2-1/8	1/2	4-1/2	\$81.52
60-270	3/4	1-5/8	3/4	5	\$188.44
60-272	3/4	2-1/8	3/4	5	\$198.60
60-278	3/4	3-1/8	3/4	6	\$224.12

HELIX ANGLE ≈ 10°

60-200



Double Flute - Solid Carbide Chipbreaker Finisher

For faster feed rates than a conventional two flute with a smooth finish.

Usage Natural wood and wood composites

Material HW CW



UPCUT

Part Number	Cutting DIA	Flute LGTH	SHK DIA	OAL	Price
60-307	3/8	1-1/8	3/8	3	\$70.92
60-311	1/2	1-1/8	1/2	3	\$96.72
60-313	1/2	1-5/8	1/2	3-1/2	\$103.24
60-317	1/2	1-7/8	1/2	3-1/2	\$109.72
60-315	1/2	2-1/8	1/2	4	\$116.20
60-321	5/8	2-1/8	5/8	4	\$225.44
60-325	3/4	2-1/8	3/4	4	\$256.76

HELIX ANGLE ≈ 30°

DOWNCUT

Part Number	Cutting DIA	Flute LGTH	SHK DIA	OAL	Price
60-308	3/8	1-1/8	3/8	3	\$70.92
60-312	1/2	1-1/8	1/2	3	\$96.72
60-314	1/2	1-5/8	1/2	3-1/2	\$103.24
60-318	1/2	1-7/8	1/2	3-1/2	\$109.72
60-316	1/2	2-1/8	1/2	4	\$116.20
60-322	5/8	2-1/8	5/8	4	\$225.44
60-326	3/4	2-1/8	3/4	4	\$256.76

60-300



ONSRUD

Three Flute - Solid Carbide Chipbreaker Finisher

For additional balance at fast feed rates with a smooth finish.

Usage

Natural wood and wood composites

Material



60-350



UPCUT

Part Number	Cutting DIA	Flute LGTH	SHK DIA	OAL	Price
60-337	3/8	1-1/8	3/8	3	\$77.24
60-351	1/2	1-1/8	1/2	3	\$104.56
60-353	1/2	1-5/8	1/2	3-1/2	\$109.68
60-361	5/8	1-5/8	5/8	4	\$225.44
60-371	3/4	1-5/8	3/4	4	\$269.32
60-375	3/4	3-1/8	3/4	6	\$425.52

DOWNCUT

Part Number	Cutting DIA	Flute LGTH	SHK DIA	OAL	Price
60-338	3/8	1-1/8	3/8	3	\$77.24
60-350	1/2	1-1/8	1/2	3	\$104.56
60-354	1/2	1-3/8	1/2	3-1/2	\$107.00
60-352	1/2	1-5/8	1/2	3-1/2	\$109.68
60-360	5/8	1-5/8	5/8	4	\$225.44
60-370	3/4	1-5/8	3/4	4	\$269.32
60-372	3/4	2-1/4	3/4	5	\$290.20
60-374	3/4	3-1/8	3/4	6	\$425.52

HELIX ANGLE ≈ 30°



Four Flute - Solid Carbide High Velocity Compression Spiral

60-600

Combine a roughing and finishing cut in one tool for rapid feed rates with a good finish.

Usage

High velocity routing of double sided laminated and veneered, natural wood and wood composites

Material



Part Number	Cutting DIA	Flute LGTH	Upcut Flute LGTH	SHK DIA	OAL	Price
60-669	1/2	1-1/8	.500	1/2	3	\$157.40
60-671	1/2	1-3/8	.500	1/2	3-1/2	\$171.52

HELIX ANGLE ≈ 30°



Four Flute - Solid Carbide High Velocity Upcut Spiral

60-700

Combine a roughing and finishing cut with upcut cutting action in one tool for rapid feed rates with a good finish.

Usage

High velocity routing of double sided laminated and veneered, natural wood and wood composites

Material



UPCUT

Part Number	Cutting DIA	Flute LGTH	SHK DIA	OAL	Price
60-711	1/2	1-1/8	1/2	3-1/2	\$163.32
60-715	1/2	1-5/8	1/2	4	\$175.48
60-719	1/2	2-1/8	1/2	4-1/2	\$211.72
60-731	3/4	2-1/8	3/4	5	\$381.16

HELIX ANGLE ≈ 30°

DOWNCUT

Part Number	Cutting DIA	Flute LGTH	SHK DIA	OAL	Price
60-710	1/2	1-1/8	1/2	3-1/2	\$163.32
60-714	1/2	1-5/8	1/2	4	\$175.48
60-718	1/2	2-1/8	1/2	4-1/2	\$211.72
60-720	5/8	2-1/8	5/8	5	\$272.32

HELIX ANGLE ≈ 30°



60-800



ONSRUD

Double Flute - Solid Carbide Rougher

Designed for use when faster feed rates cannot be achieved, or on low horsepower machines.

Usage Natural wood and wood composites

Material SW HW CW

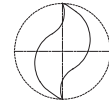

UPCUT

Part Number	Cutting DIA	Flute LGTH	SHK DIA	OAL	Price
60-815	3/8	1-3/8	3/8	3-1/2	\$81.04
60-825	1/2	1-3/8	1/2	3-1/2	\$95.56
60-829	1/2	1-7/8	1/2	4	\$104.60
60-841	5/8	2-5/8	5/8	5	\$157.88
60-847	3/4	2-7/8	3/4	6	\$266.88

DOWNCUT

Part Number	Cutting DIA	Flute LGTH	SHK DIA	OAL	Price
60-816	3/8	1-3/8	3/8	3-1/2	\$81.04
60-826	1/2	1-3/8	1/2	3-1/2	\$95.56
60-830	1/2	1-7/8	1/2	4	\$104.60
60-842	5/8	2-5/8	5/8	5	\$157.88
60-848	3/4	2-7/8	3/4	6	\$266.88

HELIX ANGLE = 20°

60-900



Three Flute - Solid Carbide Extreme Heavy Duty Hogger

Designed for heavy material removal operations where the cutter is subject to excessive cutting forces and finish is not a primary concern.

Usage Natural wood and wood composites, plastic composites

Material SW HW CW

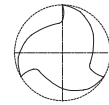

UPCUT

Part Number	Cutting DIA	Flute LGTH	SHK DIA	OAL	Price
60-901	3/8	1-1/8	3/8	3	\$69.48
60-905	1/2	1-1/8	1/2	3	\$81.00
60-907	1/2	1-5/8	1/2	3-1/2	\$104.12
60-909	1/2	2-1/8	1/2	4	\$127.40
60-915	3/4	2-1/8	3/4	5	\$196.72

DOWNCUT

Part Number	Cutting DIA	Flute LGTH	SHK DIA	OAL	Price
60-902	3/8	1-1/8	3/8	3	\$69.48
60-906	1/2	1-1/8	1/2	3	\$81.00
60-908	1/2	1-5/8	1/2	3-1/2	\$104.12
60-910	1/2	2-1/8	1/2	4	\$127.40
60-916	3/4	2-1/8	3/4	5	\$196.72

HELIX ANGLE = 30°

60-950



Double Flute - Solid Carbide Extreme Heavy Duty Chipbreaker/Finisher

Designed to be fed very fast while withstanding excessive cutting forces and at the same time leaving a smooth finish.

Usage Natural wood and wood composites

Material SW HW CW

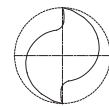

UPCUT

Part Number	Cutting DIA	Flute LGTH	SHK DIA	OAL	Price
60-951	3/8	1-1/8	3/8	3	\$43.92
60-955	1/2	1-1/8	1/2	3	\$51.00
60-957	1/2	1-5/8	1/2	3-1/2	\$64.76
60-959	1/2	2-1/8	1/2	4	\$76.40
60-965	3/4	2-1/8	3/4	5	\$162.00

DOWNCUT

Part Number	Cutting DIA	Flute LGTH	SHK DIA	OAL	Price
60-950	3/8	1-1/8	3/8	3	\$43.92
60-954	1/2	1-1/8	1/2	3	\$51.00
60-956	1/2	1-5/8	1/2	3-1/2	\$64.76
60-958	1/2	2-1/8	1/2	4	\$76.40

HELIX ANGLE = 30°

ONSRUD

Single Flute - Solid Carbide Straight

Designed to combine the fast free cutting of O flute geometry with the tool life available from solid carbide particularly in small diameters.

Usage Natural wood and aluminum

Material **SW** **A**

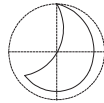

Part Number	Cutting DIA	Flute LGTH	SHK DIA	OAL	Price
61-040	1/8	1/2	1/4	2	\$27.60
61-050	5/32	9/16	1/4	2	\$27.60
61-060	3/16	5/8	1/4	2	\$27.60
61-070	7/32	5/8	1/4	2-1/2	\$27.60
61-080	1/4	3/4	1/4	2-1/2	\$27.60
61-090	9/32	3/4	3/8	2-1/2	\$47.36
61-100	5/16	13/16	3/8	2-1/2	\$47.36
61-120	3/8	7/8	3/8	2-1/2	\$47.36
61-140	7/16	1	1/2	3	\$72.32
61-160	1/2	1	1/2	3	\$72.32

61-000



Single Flute - Solid Carbide Straight

Designed to combine the fast free cutting of O flute geometry with the tool life available from solid carbide particularly in small diameters.

Usage Polycarbonate, polyethylene, polypropylene, polystyrene, PVC, extruded acrylic, HDPE, UHMW and hard plastic

Material **SP** **HP**

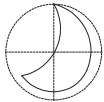

Part Number	Cutting DIA	Flute LGTH	SHK DIA	OAL	Price
61-041	1/8	5/16	1/4	2	\$23.48
61-044	1/8	1/2	1/8	2	\$21.56
61-042	1/8	1/2	1/4	2	\$25.16
61-042L	1/8	1/2	1/4	2	\$27.72
61-045	1/8	5/8	1/8	3	\$22.72
61-043	1/8	5/8	1/4	4	\$33.00
61-052	5/32	9/16	1/4	2	\$26.04
61-061	3/16	3/8	1/4	2	\$23.48
61-064	3/16	5/8	3/16	2-1/2	\$22.72
61-062	3/16	5/8	1/4	2	\$25.16
61-062L	3/16	5/8	1/4	2	\$27.72
61-063*	3/16	1	1/4	4	\$33.00
61-072	7/32	5/8	1/4	2-1/2	\$26.44
61-081	1/4	3/8	1/4	2-1/2	\$25.20
61-082	1/4	3/4	1/4	2-1/2	\$26.28
61-082L	1/4	3/4	1/4	2-1/2	\$28.88
61-083*	1/4	3/4	1/4	3-1/4	\$29.76
61-083L*	1/4	3/4	1/4	3-1/4	\$32.84
61-085*	1/4	1	1/4	3-1/4	\$31.12
61-084*	1/4	1-1/4	1/4	4	\$33.68
61-121	3/8	5/8	3/8	2-1/2	\$43.56
61-122	3/8	7/8	3/8	2-1/2	\$45.40
61-123*	3/8	1-5/8	3/8	6	\$66.84
61-162	1/2	1	1/2	3	\$65.56
61-164	1/2	1-5/8	1/2	4	\$75.04
61-166	1/2	2-1/8	1/2	6	\$89.52

61-000P



*These tools are designed and toleranced for air routers with guide bushings.
L= left hand rotation

ONSRUD Single Flute - Solid Carbide Straight Wood Rout

61-200



Designed to enhance operations where the benefits of spiral action are not needed. The single flute provides fast, free cutting with optimum cutter life.

Usage Natural wood and wood composites

Material SW HW CW

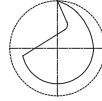

Part Number	Cutting DIA	Flute LGTH	SHK DIA	OAL	Price
61-240	1/8	1/2	1/4	2	\$27.60
61-280	1/4	7/8	1/4	2-1/2	\$27.60
61-285	1/4	1	1/4	2-1/2	\$28.96
61-320	3/8	1-1/8	3/8	3	\$47.36

61-400



Single Flute - Solid Carbide Straight

Designed to combine the fast free cutting of O flute geometry with the tool life available from solid carbide particularly in small diameters.

Usage Polycarbonate, polyethylene, polypropylene, polystyrene, PVC, extruded acrylic, HDPE, UHMW and hard plastic

Material SP HP

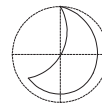

METRIC

Part Number	Cutting DIA	Flute LGTH	SHK DIA	OAL	Price
61-410	4 mm	16 mm	6 mm	64 mm	\$27.32
61-411	5 mm	20 mm	6 mm	64 mm	\$27.32
61-412	6 mm	25 mm	6 mm	64 mm	\$27.32
61-414	8 mm	25 mm	8 mm	64 mm	\$38.00
61-418	12 mm	35 mm	12 mm	88 mm	\$74.16

62-600



Single Flute - Solid Carbide Downcut Spiral O Flute

High speed cutters for machining aluminum sheet material. These tools are optimized for use on high-speed CNC mills, high speed machining centers and CNC routers.

Usage Aluminum, plate, single & multi sheet

Material A

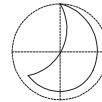

Part Number	Cutting DIA	Flute LGTH	SHK DIA	OAL	Price
62-602	1/16	1/4	1/8	1-1/2	\$23.60
62-604	1/8	1/4	1/8	1-1/2	\$24.80
62-606	1/8	1/4	1/4	2	\$29.24
62-610	1/8	1/2	1/4	2	\$31.04
62-614	3/16	3/8	1/4	2	\$31.04
62-620	1/4	3/8	1/4	2	\$30.96
62-622	1/4	3/4	1/4	2-1/2	\$33.56
62-624	1/4	1-1/4	1/4	3	\$48.28
62-630	5/16	3/4	1/2	3	\$81.68
62-625	3/8	3/4	3/8	3	\$57.36
62-631	1/2	1-1/8	1/2	3-1/2	\$88.52

HELIX ANGLE ≈ 22°

ONSRUD

Single Flute - Solid Carbide Downcut Spiral O Flute

(HP) Designed to provide a smooth finish in hard plastics with downward chip removal.

(SP) Designed to provide provide a smooth finish in soft plastic with downward chip removal.

Usage (HP): Acrylic, nylon, PVC, polycarbonate and solid surface
 (SP): HDPE, HIPS, UHMW, ABS, polycarbonate, PE, polystyrene, polypropylene, acetal, acrylic, PET and solid surface

Material 62-700 62-750 62-800 62-850

62-700
62-750
62-800
62-850

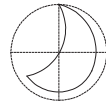

HARD PLASTIC		SOFT PLASTIC		Cutting DIA	Flute LGTH	SHK DIA	OAL	Price
Part Number	Part Number							
62-713*	62-763*	1/8	1/2	1/8	2	\$21.36		
62-712*	62-762*	1/8	1/2	1/4	2	\$23.76		
62-715*		5/32	9/16	1/4	2	\$23.20		
62-719*	62-769*	3/16	5/8	3/16	2	\$22.08		
62-718	62-768	3/16	5/8	1/4	2	\$23.76		
62-725	62-775	1/4	3/4	1/4	2-1/2	\$23.76		
62-726	62-776	1/4	1-1/4	1/4	3	\$28.16		
62-727*		1/4	1-1/2	1/4	3	\$28.36		
62-733	62-783	3/8	1-1/8	3/8	3	\$41.04		
62-740	62-790	1/2	1-5/8	1/2	3-1/2	\$104.48		

* Tool balanced by design to run at spindle speeds up to 60,000 RPM

HARD PLASTIC		SOFT PLASTIC		METRIC			HP Price
Part Number	Part Number	Cutting DIA	Flute LGTH	SHK DIA	OAL		
62-816*	62-866*	3mm	12mm	6mm	64mm	\$27.52	
62-824*	62-874*	4mm	20mm	6mm	64mm	\$27.52	
62-830	62-880	5mm	16mm	6mm	64mm	\$27.52	
62-840		6mm	30mm	6mm	76mm	\$32.76	
62-842*		6mm	38mm	6mm	76mm	\$35.16	
62-844		8mm	25mm	8mm	64mm	\$35.16	
62-846	62-896	8mm	38mm	8mm	76mm	\$35.92	

HELIX ANGLE = 21°

* Tool balanced by design to run at spindle speeds up to 60,000 RPM

63-000



Single Flute - Solid Carbide Upcut Spiral

Designed for routing where upward chip removal, tool rigidity, long life, and high quality finish is desired.

Usage Fiberglass, phenolic and aluminum

Material

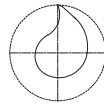

Part Number	Cutting DIA	Flute LGTH	SHK DIA	OAL	Price
63-040	1/8	1/2	1/4	2	\$24.96
63-050	5/32	9/16	1/4	2	\$24.96
63-060	3/16	5/8	1/4	2	\$24.96
63-080	1/4	3/4	1/4	2-1/2	\$24.96
63-100	5/16	13/16	3/8	2-1/2	\$47.36
63-160	1/2	1	1/2	3	\$72.32

HELIX ANGLE = 30°

63-200

ONSRUD



Single Flute - Solid Carbide Upcut Spiral Wood Rout

Designed for routing where aggressive upward chip removal is necessary in hand-fed or CNC applications. Tool rigidity, long life, and high quality finish are characteristic of these tools.

Usage Natural wood and wood composites

Material SW HW CW

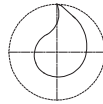

Part Number	Cutting DIA	Flute LGTH	SHK DIA	OAL	Price
63-240	1/8	1/2	1/4	2	\$24.96
63-280	1/4	7/8	1/4	2-1/2	\$24.96

HELIX ANGLE ~ 30°

63-400

Single Flute - Solid Carbide Upcut for Soft Aluminum (Coated)



These tools are specially designed to cut soft grades of aluminum and create a good edge finish. The improved cutting geometry properly forms and evacuates the chips preventing chip rewelding.

Usage Soft aluminum sheet, 3003 grade aluminum

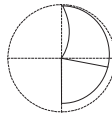

Part Number	Cutting DIA	Flute LGTH	SHK DIA	OAL	COATING	Price
63-420	3/16	1/4	1/4	2	ZRN	\$55.84
63-430	1/4	1/4	1/4	2	ZRN	\$44.00

METRIC

Part Number	Cutting DIA	Flute LGTH	SHK DIA	OAL	COATING	Price
63-450	5mm	6mm	6mm	64mm	ZRN	\$68.12
63-460	6mm	6mm	6mm	64mm	ZRN	\$50.16

CUTTING PARAMETERS

Part Number	RPM	Feed Rate
63-420	10,000	80 IPM
63-430	13,250	100 IPM
63-450	10,000	80 IPM
63-460	13,250	100 IPM

NEW

63-500

Single Flute - Solid Carbide Upcut Spiral O Flute for Acrylic



Part Number	Cutting DIA	Flute LGTH	SHK DIA	OAL	Price
63-505*	1/16	1/4	1/4	2	\$26.15
63-510	1/8	1/4	1/4	2	\$27.16
63-515*	1/8	1/2	1/4	2	\$27.16
63-520*	3/16	5/8	1/4	2	\$29.08
63-525	1/4	3/8	1/4	2-1/2	\$31.32
63-530	1/4	3/4	1/4	2-1/2	\$32.48
63-535	3/8	1-1/8	3/8	3	\$64.36

These tools are designed to cut acrylics and achieve long tool life. Our unique cutting geometry produces a smooth edge finish regardless if it is cast or extruded acrylic.

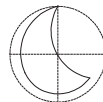

Acrylic **Usage**
SP HP Material

Tool balanced by design to run at* spindle speeds up to 60,000 RPM

ONSRUD

Single Flute - Solid Carbide Upcut Spiral O Flute

High speed cutters for machining aluminum sheet and block material. These tools are optimized for use on high-speed CNC mills, high speed machining centers and CNC routers.

Usage Aluminum plate and single/multi sheet aluminum

Material 

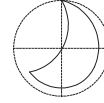

63-600



Part Number	Cutting DIA	Flute LGTH	SHK DIA	OAL	Price
63-622	1/4	3/4	1/4	2-1/2	\$33.56
63-624	1/4	11/4	1/4	3	\$48.28
63-629	5/16	9/16	5/16	2-1/2	\$53.24
63-630	5/16	3/4	1/2	3	\$81.68
63-634	21/64	3/4	1/2	3	\$57.88
63-625	3/8	3/4	3/8	3	\$57.36
63-626	3/8	1-1/8	3/8	3	\$69.48
63-627	3/8	1-3/8	3/8	3-1/2	\$74.36
63-631	1/2	1-1/8	1/2	3-1/2	\$88.52
63-632	1/2	1-3/8	1/2	3-1/2	\$94.52

Part Number	Cutting DIA	Flute LGTH	SHK DIA	OAL	Price
63-602	1/16	1/4	1/8	1-1/2	\$23.60
63-603	3/32	1/4	1/8	2	\$24.28
63-604	1/8	1/4	1/8	1-1/2	\$24.80
63-606	1/8	1/4	1/4	2	\$29.24
63-610	1/8	1/2	1/4	2	\$31.04
63-611	5/32	5/16	3/16	2	\$29.52
63-612	3/16	3/8	3/16	1-1/2	\$28.44
63-614	3/16	3/8	1/4	2	\$31.04
63-618	3/16	5/8	1/4	2	\$32.84
63-620	1/4	3/8	1/4	2	\$30.96

HELIX ANGLE ≈ 22°

ONSRUD

Single Flute - Solid Carbide Upcut Spiral O Flute

63-700
63-750
63-800
63-850



(HP) Designed to provide a smooth finish in hard plastics with upward chip removal.

(SP) Designed to provide a smooth finish in soft plastic with upward chip removal.

Usage (HP): Acrylic, nylon, PVC, polycarbonate and solid surface
(SP): HDPE, HIPS, UHMW, ABS, polycarbonate, PE, polystyrene, polypropylene, acetal, acrylic, PET and solid surface

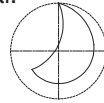

Material 63-700 **HP SSP** 63-750 **SP HP SSP**
63-800 **HP SSP** 63-850 **SP HP SSP**

HARD PLASTIC		SOFT PLASTIC				
Part Number	Part Number	Cutting DIA	Flute LGTH	SHK DIA	OAL	Price
63-701*	63-751*	1/16	1/4	1/8	2	\$21.36
63-700*	63-750*	1/16	1/4	1/4	2	\$23.76
63-706*		1/8	5/8	1/4	2-1/2	\$26.88
63-707*		1/8	3/4	1/4	2-1/2	\$28.52
63-711*	63-761*	1/8	1/4	1/8	2	\$22.08
63-710*	63-760*	1/8	1/4	1/4	2	\$23.76
63-713*	63-763*	1/8	1/2	1/8	2	\$21.36
63-712*	63-762*	1/8	1/2	1/4	2	\$23.76
63-743**	63-793**	1/8	1/2	1/4	2	\$27.12
63-715*		5/32	9/16	1/4	2	\$21.36
63-716*	63-766*	3/16	3/8	3/16	2	\$21.36
63-717*	63-767*	3/16	3/8	1/4	2	\$23.76
63-719*	63-769*	3/16	5/8	3/16	2	\$22.08
63-718*	63-768*	3/16	5/8	1/4	2	\$23.76
63-720		7/32	3/4	1/4	2-1/2	\$23.20
63-724	63-774	1/4	3/8	1/4	2	\$22.68
63-744**	63-794**	1/4	3/4	1/4	2-1/2	\$27.12
63-725	63-775	1/4	3/4	1/4	2-1/2	\$23.76
63-726	63-776	1/4	1-1/4	1/4	3	\$28.16
63-727*	63-777	1/4	1-1/2	1/4	3	\$28.36
63-730	63-780	3/8	5/8	3/8	2-1/2	\$38.32
63-731	63-781	3/8	3/4	3/8	3	\$38.76
63-733	63-783	3/8	1-1/8	3/8	3	\$41.04
63-735	63-785	3/8	1-5/8	3/8	3-1/2	\$47.16
63-745**	63-795**	3/8	1-5/8	3/8	3-1/2	\$50.84
63-740	63-790	1/2	1-5/8	1/2	3-1/2	\$94.52
63-746**	63-796**	1/2	1-5/8	1/2	3-1/2	\$97.96

HELIX ANGLE = 21°

**Special Point for Improved Bottom Finish

HARD PLASTIC		SOFT PLASTIC		METRIC		
Part Number	Part Number	Cutting DIA	Flute LGTH	SHK DIA	OAL	Price
63-802		2mm	8mm	2mm	50mm	\$22.08
63-804*	63-854	2mm	8mm	6mm	64mm	\$23.28
63-806		2.5 mm	8mm	2.5mm	50mm	\$22.08
63-808*		2.5 mm	8mm	6mm	64mm	\$23.28
63-810*	63-860*	3mm	8mm	3mm	50mm	\$22.08
63-812*	63-862*	3mm	8mm	6mm	64mm	\$23.28
63-814*	63-864*	3mm	12mm	3mm	64mm	\$22.08
63-816*	63-866*	3mm	12mm	6mm	64mm	\$23.28
63-818*		4mm	8mm	4mm	64mm	\$22.08
63-820*	63-870*	4mm	12mm	4mm	64mm	\$23.28
63-822*		4mm	20mm	4mm	64mm	\$24.44
63-824*	63-874*	4mm	20mm	6mm	64mm	\$27.52
63-826*		4mm	30mm	4mm	64mm	\$27.52
63-828	63-878*	5mm	16mm	5mm	64mm	\$22.08
63-830	63-880	5mm	16mm	6mm	64mm	\$23.28
63-832		5mm	30mm	5mm	64mm	\$33.84
63-834		6mm	8mm	6mm	64mm	\$22.28
63-836	63-886	6mm	12mm	6mm	64mm	\$22.88
63-838	63-888	6mm	20mm	6mm	64mm	\$23.28
63-840		6mm	30mm	6mm	76mm	\$27.52
63-842*	63-892*	6mm	38mm	6mm	76mm	\$27.92
63-844	63-894*	8mm	25mm	8mm	64mm	\$34.44
63-846	63-896	8mm	38mm	8mm	76mm	\$35.92
63-848	63-898	10mm	30mm	10mm	76mm	\$43.00
63-849		10mm	35mm	10mm	76mm	\$45.32
63-847	63-897	12mm	38mm	12mm	76mm	\$97.92

HELIX ANGLE = 21°

*Tool balanced by design to run at spindle speeds up to 60,000 RPM

ONSRUD

Single Flute - Solid Carbide Upcut Spiral O Flute

High speed cutters for machining aluminum sheet and block material. These tools are optimized for use on high-speed CNC mills, high speed machining centers and CNC routers.

Usage Aluminum plate and single/multi sheet aluminum

Material 

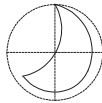

METRIC

Part Number	Cutting DIA	Flute LGTH	SHK DIA	OAL	Price
63-904	2mm	6mm	6mm	64mm	\$40.56
63-908	2.5mm	6mm	6mm	64mm	\$40.56
63-912	3mm	8mm	6mm	64mm	\$41.48
63-916	3mm	12mm	6mm	64mm	\$41.48
63-918	4mm	8mm	4mm	64mm	\$32.76
63-924	4mm	20mm	6mm	64mm	\$44.28
63-930	5mm	16mm	6mm	64mm	\$41.48
63-934	6mm	8mm	6mm	64mm	\$43.00
63-938	6mm	20mm	6mm	64mm	\$46.28
63-944	8mm	25mm	8mm	64mm	\$53.36
63-946	8mm	38mm	8mm	76mm	\$61.24
63-948	10mm	30mm	10mm	76mm	\$74.28

HELIX ANGLE ≈ 22°

63-900



Single Flute - Solid Carbide Downcut Spiral O Flute

The polished flute allows for razor sharp cutting edge and easy chip evacuation. The tool is available in a down cut spiral for improved part holding.

Usage Plastic, wood, aluminum and solid surface

Material 

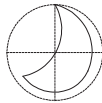

METRIC

Part Number	Cutting DIA	Flute LGTH	SHK DIA	OAL	Print
64-012M	3mm	12mm	6mm	50mm	\$26.72
64-026M	6mm	32mm	6mm	76mm	\$40.88

HELIX ANGLE ≈ 21°

Part Number	Cutting DIA	Flute LGTH	SHK DIA	OAL	Price
64-000*	1/16	1/4	1/8	2	\$27.92
64-012*	1/8	1/2	1/4	2	\$31.72
64-016*	3/16	3/8	3/16	2	\$33.60
64-018	3/16	5/8	1/4	2	\$33.60
64-024	1/4	3/8	1/4	2	\$33.60
64-025	1/4	3/4	1/4	2	\$35.88
64-026	1/4	1-1/4	1/4	3	\$49.80
64-031	3/8	3/4	3/8	3	\$61.28
64-033	3/8	1-1/8	3/8	3	\$74.68

HELIX ANGLE ≈ 21°

* Tool balanced by design to run at spindle speeds up to 60,000 RPM

64-000



65-000



ONSRUD Single Flute - Solid Carbide Upcut Spiral O Flute

The polished flute allows for razor sharp cutting edge and easy chip evacuation. The tool is available in a upcut spiral for improved chip evacuation.

Usage Plastic, wood, aluminum and solid surface

Material SW HW CW SP HP SSF A

Part Number	Cutting DIA	Flute LGTH	SHK DIA	OAL	Price
65-000*	1/16	1/4	1/8	2	\$27.92
65-010*	1/8	1/4	1/4	2	\$30.08
65-013*	1/8	1/2	1/8	2	\$28.60
65-012*	1/8	1/2	1/4	2	\$30.08
65-019*	3/16	5/8	3/16	2	\$33.32
65-018*	3/16	5/8	1/4	2	\$41.60
65-020*	3/16	1-1/4	1/4	3	\$48.08
65-021*	3/16	7/8	1/4	2-1/2	\$45.00
65-023	1/4	5/8	1/4	2	\$38.20

Part Number	Cutting DIA	Flute LGTH	SHK DIA	OAL	Price
65-025	1/4	7/8	1/4	2-1/2	\$44.28
65-026	1/4	1-1/4	1/4	3	\$54.12
65-027*	1/4	1-1/2	1/4	3	\$57.88
65-033	3/8	1-1/8	3/8	3	\$75.76

* Tool balanced by design to run at spindle speeds up to 60,000 RPM

HELIX ANGLE = 21°

* Tool balanced by design to run at spindle speeds up to 60,000 RPM

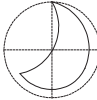

METRIC

Part Number	Cutting DIA	Flute LGTH	SHK DIA	OAL	Price
65-000M	2mm	6mm	3mm	50mm	\$40.88
65-018M	5mm	16mm	6mm	64mm	\$34.68
65-023M	6mm	16mm	6mm	64mm	\$31.88
65-033M	10mm	29mm	10mm	76mm	\$62.20

HELIX ANGLE = 22°

Two & Four Flute - High Finish Ballnose for Plastics

The tool's unique geometry, specially designed point, and highly polished primary clearance and flute give the tool the ability to attain a surface finish of 28 Ra in mechanical plastic.

Usage Plastic

Material SP

**65-200B/
65-300B**



NEW

TWO FLUTE

Part Number	Cutting DIA	Flute LGTH	SHK DIA	OAL	Flutes	Price
65-205B	1/16	1/4	1/8	2	2	\$60.40
65-210B	1/8	1/2	1/8	2-1/2	2	\$53.04
65-215B	3/16	1/2	1/4	2-1/2	2	\$68.20
65-220B	1/4	1/2	1/4	2-1/2	2	\$68.12
65-225B	1/4	1-1/8	1/4	3	2	\$71.20
65-235B	5/16	1/2	5/16	3	2	\$82.28
65-240B	5/16	1-1/8	5/16	3	2	\$85.32
65-250B	3/8	1-1/8	3/8	3	2	\$85.32
65-260B	1/2	1-1/8	1/2	3	2	\$103.40

TWO FLUTE METRIC

Part Number	Cutting DIA	Flute LGTH	SHK DIA	OAL	Flutes	Price
65-280B	3mm	12mm	3mm	64mm	2	\$55.56
65-285B	6mm	20mm	6mm	76mm	2	\$74.32
65-290B	8mm	25mm	8mm	76mm	2	\$81.16
65-295B	10mm	30mm	10mm	76mm	2	\$105.60

FOUR FLUTE

Part Number	Cutting DIA	Flute LGTH	SHK DIA	OAL	Flutes	Price
65-310B	1/4	1/2	1/4	3	4	\$71.24
65-315B	5/16	1/2	5/16	3	4	\$85.40
65-320B	3/8	5/8	3/8	3	4	\$91.84
65-325B	1/2	3/4	1/2	3	4	\$123.08

ONSRUD

Solid Carbide Edge Rounding

Designed for rounding the edge of sheets or parts.

They come in both single flute and double flute.

Usage Edge rounding of parts

Material **SP** **HP** **SSP**

66-000

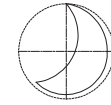

SINGLE FLUTE STRAIGHT O-FLUTE

Part Number	Cutting DIA	Flute LGTH	SHK DIA	OAL	Opening	Radius	Small Flute LGTH	Tip To RAD	Plastic Size	Price
66-082	1/4	3/8	1/4	2-1/2	5/32	1/8	.195	1/16	1/8	\$40.32
66-083	1/4	3/8	1/4	2-1/2	7/32	3/16	.180	1/16	3/16	\$40.32
66-084	1/4	3/8	1/4	2-1/2	9/32	1/4	.163	1/16	1/4	\$40.32

SINGLE FLUTE SPIRAL O-FLUTE

Part Number	Cutting DIA	Flute LGTH	SHK DIA	OAL	Opening	Radius	Small Flute LGTH	Tip To RAD	Plastic Size	Price
66-085	1/4	3/8	1/4	2-1/2	5/32	1/8	.195	1/16	1/8	\$41.32
66-086	1/4	3/8	1/4	2-1/2	7/32	3/16	.180	1/16	3/16	\$41.32
66-087	1/4	3/8	1/4	2-1/2	9/32	1/4	.163	1/16	1/4	\$41.32

HELIX ANGLE ≈ 22°

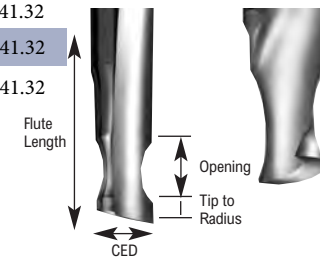

DOUBLE FLUTE STRAIGHT O-FLUTE

Part Number	Cutting DIA	Flute LGTH	SHK DIA	OAL	Opening	Radius	Small Flute LGTH	Tip To RAD	Plastic Size	Price
66-092	1/4	3/8	1/4	2-1/2	5/32	1/8	.195	1/16	1/8	\$44.32
66-093	1/4	3/8	1/4	2-1/2	7/32	3/16	.180	1/16	3/16	\$44.32
66-094	1/4	3/8	1/4	2-1/2	9/32	1/4	.163	1/16	1/4	\$44.32

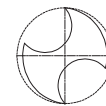

DOUBLE FLUTE STRAIGHT V-FLUTE

Part Number	Cutting DIA	Flute LGTH	SHK DIA	OAL	Opening	Radius	Small Flute LGTH	Tip To RAD	Plastic Size	Price
66-120	3/8	3/8	3/8	2-1/2	5/32	1/8	.320	1/16	1/8	\$65.04
66-121	3/8	3/8	3/8	2-1/2	7/32	3/16	.305	1/16	3/16	\$65.04
66-122	3/8	3/8	3/8	2-1/2	9/32	1/4	.288	1/16	1/4	\$65.04
66-123	3/8	1/2	3/8	2-1/2	13/32	3/8	.255	1/16	3/8	\$65.04
66-160	1/2	3/8	1/2	3	5/32	1/8	.445	1/16	1/8	\$92.64
66-161	1/2	3/8	1/2	3	7/32	3/16	.430	1/16	3/16	\$92.64
66-162	1/2	3/8	1/2	3	9/32	1/4	.413	1/16	1/4	\$92.64
66-163	1/2	5/8	1/2	3	17/32	1/2	.347	1/16	1/2	\$92.64



66-200



ONSRUD

Double Flute - Solid Carbide Roud and Chamfer

Designed to provide up to a 1/16" top face chamfer and a finished side edge on plastic sheets or parts.

Usage Roud and chamfer in plastic

Material **SP** **HP**

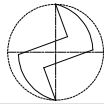

Part Number	Cutting DIA	Flute LGTH	SHK DIA	OAL	Material Thickness	Price
66-200	1/4	3/16	3/8	2-1/4	1/8	\$52.68
66-204	1/4	1/4	3/8	2-1/4	3/16	\$52.68
66-210	3/8	5/16	1/2	3	1/4	\$64.72

HELIX ANGLE ~ 0°

66-300



Double Flute - Solid Carbide Upcut Bottom Surfacing

Designed for pocketing applications where the bottom of the pocket must be smooth.

Usage Bottom surfacing for plastic and aluminum

Material **SP** **HP**

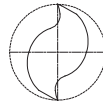

Part Number	Cutting DIA	Corner Radius	Flute LGTH	SHK DIA	OAL	Price
66-308	1/8	.020	1/4	1/4	2	\$29.76
66-309	1/8	.002	1/4	1/4	2	\$29.76
66-314	1/4	.030	3/8	1/4	2	\$31.32
66-315	1/4	.002	3/8	1/4	2	\$31.32
66-320	3/8	.030	5/8	3/8	2-1/2	\$46.80
66-321	3/8	.002	5/8	3/8	2-1/2	\$46.80
66-326	1/2	.030	7/8	1/2	3	\$73.48
66-327	1/2	.002	7/8	1/2	3	\$73.48
66-328	3/4	.040	1-1/8	3/4	4	\$109.92

HELIX ANGLE ~ 30°

66-800



DFC Compression for Composites (Coated)

The diamond film coated (CVD) solid carbide compression routers unique geometry prevents delamination on top and the bottom edges of the composites. The open flute geometry dissipates heat to prevent resin flow.

Usage Composite

Material **CP**

Part Number	Cutting DIA	Flute LGTH	Upcut LGTH	SHK DIA	OAL	Flutes	Price
66-802DFC	1/4	3/4	.325	1/4	3-1/2	4	\$164.20
66-811DFC*	3/8	1	.100	3/8	4	4	\$249.80
66-814DFC	3/8	1	.340	3/8	4	6	\$256.92
66-817DFC*	1/2	1-1/8	.100	1/2	4	6	\$298.08
66-823DFC	1/2	1-1/8	.350	1/2	4	6	\$823.00

*DOWNCUT EDGE TO WITHIN .050" OF TOOL END

METRIC

Part Number	Cutting DIA	Flute LGTH	Upcut LGTH	SHK DIA	OAL	Flutes	Price
66-852DFC	6mm	20mm	7.75mm	6mm	90mm	4	\$173.36
66-858DFC	8mm	25mm	8mm	8mm	100mm	4	\$252.16
66-864DFC	10mm	25mm	8.5mm	10mm	100mm	6	\$293.72
66-870DFC	12mm	25mm	9mm	12mm	100mm	6	\$330.44

NEW

ONSRUD

High Performance Composite Router (Coated)

The new High Performance Composite Router is designed for more efficient routing of composite materials, in both hand-fed and in CNC applications. Coated with AlTiN for increased tool life.

Usage Composites and fiberglass

Material 

Part Number	Point Style	Cutting DIA	Flute LGTH	SHK DIA	OAL	Price
66-901ALTIN	No	1/8	1/2	1/8	1-1/2	\$30.64
66-902ALTIN	BURR	1/8	1/2	1/8	1-1/2	\$44.40
66-903ALTIN	Endmill	1/8	1/2	1/8	1-1/2	\$35.20
66-904ALTIN	Drill	1/8	1/2	1/8	1-1/2	\$41.40
66-905ALTIN	No	3/16	5/8	1/4	2	\$48.52
66-906ALTIN	BURR	3/16	5/8	1/4	2	\$62.28
66-907ALTIN	Endmill	3/16	5/8	1/4	2	\$53.08
66-908ALTIN	Drill	3/16	5/8	1/4	2	\$59.52
66-909ALTIN	No	1/4	1	1/4	3	\$47.04
66-910ALTIN	BURR	1/4	1	1/4	3	\$60.80
66-911ALTIN	Endmill	1/4	1	1/4	3	\$51.60
66-912ALTIN	Drill	1/4	1	1/4	3	\$58.04
66-913ALTIN	No	1/4	1-1/2	1/4	3-1/2	\$50.00
66-914ALTIN	BURR	1/4	1-1/2	1/4	3-1/2	\$63.80
66-915ALTIN	Endmill	1/4	1-1/2	1/4	3-1/2	\$54.60
66-916ALTIN	Drill	1/4	1-1/2	1/4	3-1/2	\$61.04
66-917ALTIN	No	1/4	2-1/8	1/4	4	\$56.16
66-918ALTIN	BURR	1/4	2-1/8	1/4	4	\$69.96
66-919ALTIN	Endmill	1/4	2-1/8	1/4	4	\$60.76
66-920ALTIN	Drill	1/4	2-1/8	1/4	4	\$67.20
66-921ALTIN	No	3/8	1	3/8	3	\$66.92
66-922ALTIN	BURR	3/8	1	3/8	3	\$80.68
66-923ALTIN	Endmill	3/8	1	3/8	3	\$71.52
66-924ALTIN	Drill	3/8	1	3/8	3	\$77.96
66-925ALTIN	No	3/8	1-5/8	3/8	3-1/2	\$80.00
66-926ALTIN	BURR	3/8	1-5/8	3/8	3-1/2	\$93.76
66-927ALTIN	Endmill	3/8	1-5/8	3/8	3-1/2	\$80.00
66-928ALTIN	Drill	3/8	1-5/8	3/8	3-1/2	\$91.00
66-929ALTIN	No	3/8	2-1/8	3/8	4	\$81.56
66-930ALTIN	BURR	3/8	2-1/8	3/8	4	\$95.32
66-931ALTIN	Endmill	3/8	2-1/8	3/8	4	\$86.16
66-932ALTIN	Drill	3/8	2-1/8	3/8	4	\$92.56
66-933ALTIN	No	1/2	1-1/8	1/2	3	\$88.76
66-934ALTIN	BURR	1/2	1-1/8	1/2	3	\$102.56
66-935ALTIN	Endmill	1/2	1-1/8	1/2	3	\$93.36
66-936ALTIN	Drill	1/2	1-1/8	1/2	3	\$99.76
66-937ALTIN	No	1/2	1-5/8	1/2	4	\$103.24
66-938ALTIN	BURR	1/2	1-5/8	1/2	4	\$117.00

Part Number	Point Style	Cutting DIA	Flute LGTH	SHK DIA	OAL	Price
66-939ALTIN	Endmill	1/2	1-5/8	1/2	4	\$107.84
66-940ALTIN	Drill	1/2	1-5/8	1/2	4	\$114.28
66-941ALTIN	No	1/2	2-1/8	1/2	4	\$104.56
66-942ALTIN	BURR	1/2	2-1/8	1/2	4	\$118.32
66-943ALTIN	Endmill	1/2	2-1/8	1/2	4	\$109.16
66-944ALTIN	Drill	1/2	2-1/8	1/2	4	\$115.56
66-945ALTIN	No	1/2	3-1/8	1/2	5	\$120.28
66-946ALTIN	BURR	1/2	3-1/8	1/2	5	\$134.08
66-947ALTIN	Endmill	1/2	3-1/8	1/2	5	\$127.48
66-948ALTIN	Drill	1/2	3-1/8	1/2	5	\$131.32
66-949ALTIN	No	1/2	4-1/8	1/2	6	\$136.24
66-950ALTIN	BURR	1/2	4-1/8	1/2	6	\$150.00
66-951ALTIN	Endmill	1/2	4-1/8	1/2	6	\$140.84
66-952ALTIN	Drill	1/2	4-1/8	1/2	6	\$147.28
66-971ALTIN	No	4mm	16mm	6mm	50mm	\$58.40
66-972ALTIN	BURR	4mm	16mm	6mm	50mm	\$72.16
66-973ALTIN	Endmill	4mm	16mm	6mm	50mm	\$62.96
66-974ALTIN	Drill	4mm	16mm	6mm	50mm	\$69.40
66-975ALTIN	No	6mm	19mm	6mm	75mm	\$54.28
66-976ALTIN	BURR	6mm	19mm	6mm	75mm	\$68.04
66-977ALTIN	Endmill	6mm	19mm	6mm	75mm	\$58.88
66-978ALTIN	Drill	6mm	19mm	6mm	75mm	\$65.32
66-979ALTIN	No	6mm	25mm	6mm	75mm	\$59.64
66-980ALTIN	BURR	6mm	25mm	6mm	75mm	\$73.44
66-981ALTIN	Endmill	6mm	25mm	6mm	75mm	\$64.24
66-982ALTIN	Drill	6mm	25mm	6mm	75mm	\$70.68
66-983ALTIN	No	8mm	25mm	8mm	63mm	\$72.64
66-984ALTIN	BURR	8mm	25mm	8mm	63mm	\$86.44
66-985ALTIN	Endmill	8mm	25mm	8mm	63mm	\$77.24
66-986ALTIN	Drill	8mm	25mm	8mm	63mm	\$83.68
66-987ALTIN	No	10mm	25mm	10mm	75mm	\$91.68
66-988ALTIN	BURR	10mm	25mm	10mm	75mm	\$105.44
66-989ALTIN	Endmill	10mm	25mm	10mm	75mm	\$96.28
66-990ALTIN	Drill	10mm	25mm	10mm	75mm	\$102.68
66-991ALTIN	No	12mm	25mm	12mm	75mm	\$123.52
66-992ALTIN	BURR	12mm	25mm	12mm	75mm	\$137.32
66-993ALTIN	Endmill	12mm	25mm	12mm	75mm	\$128.12
66-994ALTIN	Drill	12mm	25mm	12mm	75mm	\$134.56

66-900



NEW

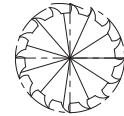

Burr Point



Drill Point

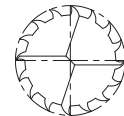

End Mill Point

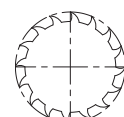

No Point

67-000
67-250

ONSRUD Solid Carbide Fiberglass Router

Designed as fiberglass routers. Their upcut/downcut diamond design effectively shears fibrous materials. Certain tools in the line have been further developed to cut aramid fiber composites.

Usage Fiberglass and composites

Material 



MEDIUM BURR W/END MILL POINT

Part Number	Cutting DIA	Flute LGTH	SHK DIA	OAL	Price
67-003	1/8	1	1/8	2	\$23.44
67-010	1/4	3/4	1/4	2-1/2	\$39.88
67-011	1/4	1-1/8	1/4	3	\$42.04
67-012	1/4	1-1/4	1/4	3	\$40.72
67-014	1/4	1-1/2	1/4	3	\$49.80
67-017	1/4	2-1/8	1/4	4	\$55.52
67-030	3/8	7/8	3/8	2-1/2	\$59.64

MEDIUM BURR W/END MILL POINT

Part Number	Cutting DIA	Flute LGTH	SHK DIA	OAL	Price
67-023	3/8	1-5/8	3/8	3	\$66.32
67-027	3/8	2-1/8	3/8	4	\$78.60
67-031	1/2	1-1/8	1/2	3	\$75.24
67-033	1/2	1-5/8	1/2	4	\$89.16
67-037	1/2	2-1/8	1/2	4	\$97.20
67-039	1/2	3-1/8	1/2	5	\$131.92
67-065	3/4	4-1/8	3/4	6	\$209.44

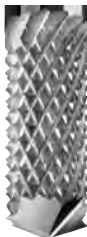

MEDIUM BURR W/DRILL POINT

Part Number	Cutting DIA	Flute LGTH	SHK DIA	OAL	Price
67-080	1/4	3/4	1/4	2-1/2	\$27.12
67-120	3/8	7/8	3/8	2-1/2	\$61.08
67-160	1/2	1	1/2	3	\$81.12



3 FLUTE DOWNCUT DIAMOND GRIT TOOL

Part Number	Cutting DIA	Flute LGTH	SHK DIA	OAL	Price
67-254	1/4	1-1/8	1/4	3	\$134.04

3 FLUTE DOWNCUT DIAMOND GRIT TOOL

Part Number	Cutting DIA	Flute LGTH	SHK DIA	OAL	Price
67-256	1/4	1-3/8	1/4	3	\$134.04
67-258	3/8	1-3/8	3/8	3	\$174.68

67-200

Three Flute - Solid Carbide Phenolic Cutter

Equally adaptable to low or high spindle speed applications in any CNC machining environment. The free cutting action of the tools provides for better finishes and significantly lower noise levels.

Usage Phenolic

Material 



UPCUT HELIX ANGLE ~ 10°

Part Number	Cutting DIA	Flute LGTH	SHK DIA	OAL	Price
67-205	3/8	7/8	3/8	3	\$76.80
67-211	1/2	1-1/8	1/2	3	\$94.52
67-215	1/2	2-1/8	1/2	4	\$112.12

DOWNCUT

Part Number	Cutting DIA	Flute LGTH	SHK DIA	OAL	Price
67-206	3/8	7/8	3/8	3	\$76.80
67-212	1/2	1-1/8	1/2	3-1/2	\$94.52
67-216	1/2	2-1/8	1/2	4-1/2	\$112.12

METRIC

Part Number	Cutting DIA	Flute LGTH	SHK DIA	OAL	Price
67-207	10mm	22mm	10mm	75mm	\$70.48
67-209	12mm	28mm	12mm	75mm	\$78.20

METRIC

Part Number	Cutting DIA	Flute LGTH	SHK DIA	OAL	Price
67-208	10mm	22mm	10mm	75mm	\$71.48
67-210	12mm	28mm	12mm	75mm	\$79.84

ONSRUD

Usage Composites and phenolic

Material **CP**

Three Flute - PCD Progressive Chipbreaker for Composites

Provides superior chip control and increased tool life when cutting dense and abrasive materials. The new chipbreaker incorporates a unique geometry with a PCD cutting edge to support a wide range of feed rates and depth of cut combinations while extending the life of the tool. This is accomplished by utilizing a distinct Hi-Low asymmetrical chipbreaker profile which reduces vibration and chatter, caused by harmonic imbalance, resulting in improved surface finishes, while reducing noise levels and wear on the tool.

Part Number	Cutting DIA	Flute LGTH	SHK DIA	OAL	Price
67-221	3/8	3/8	3/8	3	\$312.80
67-225	1/2	5/8	1/2	3	\$480.66
67-227	1/2	1-1/8	1/2	3	\$688.06

METRIC

Part Number	Cutting DIA	Flute LGTH	SHK DIA	OAL	Price
67-230	10mm	12mm	10mm	76mm	\$429.72
67-233	12mm	20mm	12mm	100mm	\$613.72

67-220



NEW

Double Flute - Solid Carbide Compression Spiral

Compression design for fast feed and excellent finish on both sides of the material.

Usage Composite panels and honeycomb core

Material **CP**

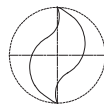

Part Number	Cutting DIA	Flute LGTH	SHK DIA	OAL	Diamond Coated Part Number	Price
67-305	1/4	7/8	1/4	2-1/2	-	\$64.92
67-314	3/8	1-1/8	3/8	3	67-314DFC	\$79.76
67-320*	1/2	7/8	1/2	3	-	\$94.44
67-322	1/2	1-1/8	1/2	3	67-322DFC	\$94.96

* = Mortise Compression

HELIX ANGLE ≈ 30°

67-300



Solid Carbide Un-Ruffer™^{PATENTED}

The unique design allows for the cutting performance of a burr while achieving a good surface finish.

Usage Composite panels

Material **CP** **METRIC**

Part Number	Cutting DIA	Flute LGTH	SHK DIA	OAL	Price
67-426M	6mm	25mm	6mm	64mm	\$61.88
67-435M	10mm	25mm	10mm	76mm	\$89.56
67-445M	12mm	25mm	12mm	76mm	\$124.44

Part Number	Cutting DIA	Flute LGTH	SHK DIA	OAL	Price
67-423	1/4	3/4	1/4	2	\$70.44
67-426	1/4	1	1/4	2-1/2	\$74.96
67-428	1/4	1	1/4	3	\$75.76
67-435	3/8	1	3/8	3	\$103.04
67-445	1/2	1	1/2	3	\$145.88

67-400



Solid Carbide CG Tool (Carbon Graphite)

The geometry of these tools increases the amount of effective cutting flutes resulting in superior performance over a standard burr.

Usage Carbon graphite and carbon fiber panels

Material **CP**

Part Number	Cutting DIA	Flute LGTH	SHK DIA	OAL	Price
67-505	1/8	1/2	1/8	2	\$81.60
67-508	3/16	5/8	3/16	2	\$84.52
67-511	1/4	3/4	1/4	3	\$85.04
67-514	1/4	1-1/2	1/4	3	\$86.84
67-520	3/8	1-1/8	3/8	3-1/2	\$91.84
67-523	1/2	1-1/8	1/2	3-1/2	\$99.48
67-526	1/2	2-1/8	1/2	4	\$106.88

67-500



67-800



ONSRUD

Solid Carbide 8 Facet Drill

Designed to reduce cutting forces and eliminating delamination when exiting the material.

Usage Composites, Carbon fiber, mechanical plastics, and fiber reinforced plastics

Call for Pricing.

What is an 8 Facet Drill?

An 8 facet drill consists of 4 cutting edges with 2 facets per cutting edge. These facets consist of the lip relief and the lip clearance angle.

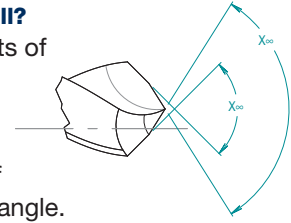

FRACTIONAL DRILLS

Part Number	Cutting DIA	Flute LGTH	SHK DIA	OAL
67-807	1/8 (0.1250)	1-1/4	0.125	2-1/4
67-808	9/64 (0.1406)	1-3/8	0.140	2-1/2
67-809	5/32 (0.1563)	1-3/8	0.156	2-1/2
67-810	11/64 (0.1719)	1-5/8	0.172	2-3/4
67-811	3/16 (0.1875)	1-5/8	0.188	2-3/4
67-812	13/64 (0.2013)	1-3/4	0.203	3
67-813	7/32 (0.2188)	1-3/4	0.219	3
67-814	15/64 (0.2344)	2	0.234	3-1/4
67-815	1/4 (0.2500)	2	0.250	3-1/4
67-816	17/64 (0.2656)	2-1/8	0.266	3-1/2
67-817	9/32 (0.2813)	2-1/8	0.281	3-1/2
67-818	19/64 (0.2969)	2-3/8	0.297	3-3/4
67-819	5/16 (0.3125)	2-3/8	0.313	3-3/4
67-820	21/64 (0.3281)	2-1/2	0.328	4
67-821	11/32 (0.3438)	2-1/2	0.344	4
67-822	23/64 (0.3594)	2-1/2	0.359	4
67-823	3/8 (0.3750)	2-3/4	0.375	4-1/4
67-824	25/64 (0.3906)	2-7/8	0.391	4-1/2
67-825	13/32 (0.4063)	2-7/8	0.406	4-1/2
67-826	27/64 (0.4219)	2-7/8	0.422	4-1/2
67-827	7/16 (0.4375)	2-7/8	0.438	4-1/2
67-828	29/64 (0.4531)	3	0.453	4-3/4
67-829	15/32 (0.4688)	3	0.469	4-3/4
67-830	31/64 (0.4844)	3	0.484	4-3/4
67-831	1/2 (0.5000)	3	0.500	4-3/4

LETTER DRILLS (CONT.)

Part Number	Cutting DIA	Flute LGTH	SHK DIA	OAL
67-850	A (0.2340)	2	0.234	3-1/4
67-851	B (0.2380)	2	0.238	3-1/4
67-852	C (0.2420)	2	0.242	3-1/4
67-853	D (0.2460)	2	0.246	3-1/4
67-854	E (0.2500)	2	0.250	3-1/4
67-855	F (0.2570)	2	0.257	3-1/4
67-856	G (0.2610)	2-1/8	0.261	3-1/2
67-857	H (0.2660)	2-1/8	0.266	3-1/2
67-858	I (0.2720)	2-1/8	0.272	3-1/2

LETTER DRILLS (CONT.)

Part Number	Cutting DIA	Flute LGTH	SHK DIA	OAL
67-859	J (0.2770)	2-1/8	0.277	3-1/2
67-860	K (0.2810)	2-1/8	0.281	3-1/2
67-861	L (0.2910)	2-1/8	0.291	3-1/2
67-862	M (0.2950)	2-3/8	0.295	3-3/4
67-863	N (0.3020)	2-3/8	0.302	3-3/4
67-864	O (0.3160)	2-3/8	0.316	3-3/4
67-865	P (0.3230)	2-3/8	0.323	3-3/4
67-866	Q (0.3320)	2-1/2	0.332	4
67-867	R (0.3390)	2-1/2	0.339	4
67-868	S (0.3480)	2-1/2	0.348	4
67-869	T (0.3580)	2-1/2	0.358	4
67-870	U (0.3680)	2-3/4	0.368	4-1/4
67-871	V (0.3770)	2-3/4	0.377	4-1/4
67-872	W (0.3860)	2-7/8	0.386	4-1/2
67-873	X (0.3970)	2-7/8	0.397	4-1/2
67-874	Y (0.4040)	2-7/8	0.404	4-1/2
67-875	Z (0.4130)	2-7/8	0.413	4-1/2

NUMBER DRILLS

Part Number	Cutting DIA	Flute LGTH	SHK DIA	OAL
67-876	1 (0.2280)	1-3/4	0.228	3
67-877	2 (0.2210)	1-3/4	0.221	3
67-878	3 (0.2130)	1-3/4	0.213	3
67-879	4 (0.2090)	1-3/4	0.209	3
67-880	5 (0.2055)	1-3/4	0.206	3
67-881	6 (0.2040)	1-3/4	0.204	3
67-882	7 (0.2010)	1-3/4	0.201	3
67-883	8 (0.1990)	1-3/4	0.199	3
67-884	9 (0.1960)	1-3/4	0.196	3
67-885	10 (0.1935)	1-5/8	0.194	2-3/4
67-886	11 (0.1910)	1-5/8	0.191	2-3/4
67-887	12 (0.1890)	1-5/8	0.189	2-3/4
67-888	13 (0.1850)	1-5/8	0.185	2-3/4
67-889	14 (0.1820)	1-5/8	0.182	2-3/4
67-890	15 (0.1800)	1-5/8	0.180	2-3/4
67-891	16 (0.1770)	1-5/8	0.177	2-3/4
67-892	17 (0.1730)	1-5/8	0.173	2-3/4

NUMBER DRILLS (CONT.)

Part Number	Cutting DIA	Flute LGTH	SHK DIA	OAL
67-893	18 (0.1695)	1-5/8	0.170	2-3/4
67-894	19 (0.1660)	1-5/8	0.166	2-3/4
67-895	20 (0.1610)	1-3/8	0.161	2-1/2
67-896	21 (0.1590)	1-3/8	0.159	2-1/2
67-897	22 (0.1570)	1-3/8	0.157	2-1/2
67-898	23 (0.1540)	1-3/8	0.154	2-1/2
67-899	24 (0.1520)	1-3/8	0.152	2-1/2
67-900	25 (0.1495)	1-3/8	0.150	2-1/2
67-901	26 (0.1470)	1-3/8	0.147	2-1/2
67-902	27 (0.1440)	1-3/8	0.144	2-1/2
67-903	28 (0.1405)	1-3/8	0.141	2-1/2
67-904	29 (0.1360)	1-3/8	0.136	2-1/2
67-905	30 (0.1285)	1-1/4	0.129	2-1/4
67-906	31 (0.1200)	1-1/4	0.120	2-1/4

METRIC DRILLS

Part Number	Cutting DIA	Flute LGTH	SHK DIA	OAL
67-961	3.00 (0.1181)	32	3.00	57
67-962	3.50 (0.1378)	35	3.50	64
67-963	4.00 (0.1575)	35	4.00	64
67-964	4.50 (0.1772)	41	4.50	70
67-965	5.00 (0.1969)	44	5.00	76
67-966	5.50 (0.2165)	44	5.50	76
67-967	6.00 (0.2362)	51	6.00	83
67-968	6.50 (0.2559)	51	6.50	83
67-969	7.00 (0.2756)	57	7.00	89
67-970	7.50 (0.2953)	60	7.50	95
67-971	8.00 (0.3150)	60	8.00	95
67-972	8.50 (0.3346)	64	8.50	102
67-973	9.00 (0.3543)	64	9.00	102
67-974	9.50 (0.3740)	70	9.50	108
67-975	10.00 (0.3937)	73	10.00	114
67-976	10.50 (0.4134)	73	10.50	114
67-977	11.00 (0.4331)	73	11.00	114
67-978	11.50 (0.4528)	76	11.50	121
67-979	12.00 (0.4724)	76	12.00	121

ONSRUD

Double Flute - PCD Tipped Tooling

Designed for use in abrasive materials where cut quality and tool life are important.

Usage Composite panels and fiberglass

Material **CP**



PCD Tipped



PCD Full Face with Plunge Point

PCD FULL FACE

Part Number	Cutting DIA	Flute LGTH	SHK DIA	OAL	Price
68-005	1/4	3/4	1/4	3	\$254.88
68-010	3/8	3/4	3/8	3	\$327.52
68-020	1/2	3/4	1/2	4	\$359.20
68-030	3/4	1	3/4	4	\$432.92

HELIX ANGLE ≈ 0-3°

PCD FULL FACE with PLUNGE POINT

Part Number	Cutting DIA	Flute LGTH	SHK DIA	OAL	Price
68-050	1/4	3/4	1/4	3	\$339.84
68-055	3/8	7/8	3/8	3	\$421.64
68-062	1/2	1-1/4	1/2	4	\$612.04
68-070	3/4	1-1/4	3/4	4	\$619.24
68-072	3/4	1-1/4	3/4	4	\$609.00

Down Shear

68-000



Single Flute - PCD Compression Tool

This economical PCD compression tool will provide long tool life in abrasive wood products. Mortise tip allowing for through cuts and dado's to be produced using one tool. The compression design ensures chip free edges on the top and bottom.

Usage Composite wood

Material **CW**

Part Number	Cutting DIA	Flute LGTH	Upcut Flute LGTH	Flute SHK DIA	OAL	Flutes	Price
68-101	3/8	1	0.188	3/8	3	1	\$165.28
68-101L	3/8	1	0.188	3/8	3	1	\$181.80
68-100	3/8	1	0.188	1/2	3	1	\$165.28
68-100L	3/8	1	0.188	1/2	3	1	\$181.80
68-102	1/2	1	0.200	1/2	3	1	\$174.00
68-102L	1/2	1	0.200	1/2	3	1	\$191.36
68-103	1/2	1-1/4	0.200	1/2	3	1	\$191.36
68-104	5/8	1	0.200	5/8	3-1/2	1	\$182.68

Part Number	Cutting DIA	Flute LGTH	Upcut Flute LGTH	Flute SHK DIA	OAL	Flutes	Price
68-104L*	5/8	1	0.200	5/8	3-1/2	1	\$200.92
68-110	5/8	1-5/8	0.200	5/8	4	1	\$374.04
68-110L*	5/8	1-5/8	0.200	5/8	4	1	\$300.96
68-106	3/4	1	0.200	3/4	4	1	\$182.68
68-106L*	3/4	1	0.200	3/4	4	1	\$200.92
68-112	3/4	1-5/8	0.200	3/4	4	1	\$274.04
68-112L*	3/4	1-5/8	0.200	3/4	4	1	\$300.96

L = Left Hand Rotation

*= Tools are not stocked and must be special ordered. Approx. 4 week lead time.

68-100



68-200

ONSRUD

Double Flute - PCD SERF™ Cutter



This tool is designed to act like a rougher and finishing tool in one. The unique geometry reduces the cutting forces resulting in longer tool life, higher feed rates and reduced noise.

Usage Composites

Material **CP** **METRIC**

Part Number	Cutting DIA	Flute LGTH	SHK DIA	OAL	Price
68-213M	6mm	20mm	6mm	76mm	\$308.24
68-226M	10mm	25mm	10mm	88mm	\$428.92
68-236M	12mm	32mm	12mm	100mm	\$502.80

Part Number	Cutting DIA	Flute LGTH	SHK DIA	OAL	Price
68-210	1/4	3/8	1/4	3	\$279.04
68-213	1/4	3/4	1/4	3	\$354.72
68-216	1/4	1	1/4	3-1/2	\$406.72
68-220	3/8	3/8	3/8	3	\$416.20
68-223	3/8	3/4	3/8	3	\$472.96
68-226	3/8	1	3/8	3-1/2	\$496.60
68-230	1/2	3/4	1/2	4	\$520.28
68-233	1/2	1	1/2	4	\$539.16
68-236	1/2	1-1/4	1/2	4	\$577.04

Three Flute - PCD SERFIN™ Cutter

68-300



Three-Flute tool with two roughing edges that have geometry to reduce cutting forces and shear fibers in high-strength composite and other fiber reinforced plastic materials. The finishing edge cleans up after roughing cuts to create a smooth edge on material.

Usage Composites

Material **CP**

NEW

Part Number	Cutting DIA	Flute LGTH	SHK DIA	OAL	Price
68-315	3/8	1/2	3/8	4	\$513.40
68-320	3/8	7/8	3/8	4	\$636.60
68-340	1/2	5/8	1/2	4	\$642.60
68-345	1/2	1	1/2	4	\$875.32
68-350	1/2	1-1/4	1/2	4	\$1018.44
68-360	3/4	1-3/8	3/4	5	\$1399.40

METRIC

Part Number	Cutting DIA	Flute LGTH	SHK DIA	OAL	Price
68-310	8mm	10mm	8mm	76mm	\$424.76
68-325	10mm	14mm	10mm	100mm	\$543.32
68-330	12mm	14mm	12mm	100mm	\$586.40
68-335	12mm	26mm	12mm	100mm	\$865.92
68-355	16mm	26mm	16mm	100mm	\$1031.80

68-400

Double Flute - PCD Ballnose



Designed for use in abrasive materials where cut quality and tool life are important.

Usage Composites

NEW

Part Number	Cutting DIA	Flute LGTH	SHK DIA	OAL	Price
68-405	1/4	3/8	1/4	2-1/2	\$267.68
68-410	3/8	1/2	3/8	3	\$354.08
68-420	1/2	5/8	1/2	4	\$458.72
68-425	5/8	7/8	5/8	4	\$622.00
68-430	3/4	1	3/4	4	\$786.28

METRIC

Part Number	Cutting DIA	Flute LGTH	SHK DIA	OAL	Price
68-440	6mm	10mm	6mm	76mm	\$276.72
68-445	8mm	10mm	8mm	76mm	\$307.92
68-450	10mm	12mm	10mm	76mm	\$379.88
68-455	12mm	20mm	12mm	100mm	\$506.24

ONSRUD

PCD 8 Facet Drills

The PCD 8 facet drill works well in composite material where long tool life and a delamination free hole is required. The drill diameters are oversize allowing for aircraft fasteners to extend through the holes.

Usage Composites **Material** **CP**

What is an 8 Facet Drill?

An 8 facet drill consists of 4 cutting edges with 2 facets per cutting edge. These facets consist of the lip relief and the lip clearance angle.

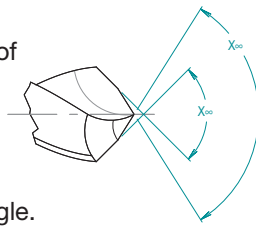

Part Number	Cutting DIA	Flute LGTH	SHK DIA	OAL	Price
68-902	0.100	1	1/4	3	\$1038.64
68-904	0.129	1	1/4	3	\$559.12
68-908	0.147	1	1/4	3	\$582.48
68-910	0.192	1	1/4	3	\$595.92
68-914	0.251	1	1/4	3	\$613.76
68-918	0.313	1	5/16	3	\$718.44
68-922	0.376	1	3/8	3	\$799.72
68-926	0.502	1	1/2	3	\$918.04

68-900



Carbide Tipped Trim Blade and Arbor

Designed to trim and groove both hard and soft plastics. These blades run in conjunction with the blade arbors. Blades are reversible for right or left hand rotation cutting.

Usage Hard and soft plastic

Material **SP** **HP**

SOFT PLASTIC - SLOW FEED

Part Number	Cutting DIA	Teeth	Rake	Kerf	Grind	Price
70-100	2	10	0°	.095	TCG	\$94.48
70-102	2-1/2	10	0°	.095	TCG	\$94.48
70-104	3	10	0°	.095	TCG	\$94.48
70-108	4	10	0°	.095	TCG	\$94.48

HARD PLASTIC - FAST FEED

Part Number	Cutting DIA	Teeth	Rake	Kerf	Grind	Price
70-160	2	16	-5°	.095	TCG	\$103.92
70-162	2-1/2	20	-5°	.095	TCG	\$103.92
70-164	3	20	-5°	.095	TCG	\$103.92
70-166	3-1/2	20	-5°	.095	TCG	\$103.92
70-168	4	20	-5°	.095	TCG	\$103.92

TCG = Triple Chip Grind

SOFT PLASTIC - FAST FEED

Part Number	Cutting DIA	Teeth	Rake	Kerf	Grind	Price
70-120	2	16	0°	.095	TCG	\$103.92
70-122	2-1/2	20	0°	.095	TCG	\$103.92
70-124	3	20	0°	.095	TCG	\$103.92
70-126	3-1/2	20	0°	.095	TCG	\$103.92
70-128	4	20	0°	.095	TCG	\$103.92

SAW ARBOR - These saw arbors are designed to hold the carbide tipped saws.

Part Number	Cutting DIA	OAL	Price
70-180	1/2	3-1/4	\$96.16
70-181	1/2	4-1/2	\$106.04

70-100



Feeds & Speeds for Blades

INCHES PER MINUTE

Tool Series	Cutting DIA	Max RPM	Soft Plastic	Hard Plastic	Fibrous Reinfrc
70-100	2"	18,000	150	150	150
70-100	2-1/2"	16,000	150	150	150
70-100	3"	14,000	150	150	150
70-100	3-1/2"	12,000	150	150	150
70-100	4"	10,000	150	150	150
70-200	1-1/2" & Smaller	14,000	150	150	150
70-300	2"	16,000	150	150	150

ONSRUD

70-200



Solid Carbide Trim Blade Flush Mount

These small diameter solid carbide arbor mounted blades are designed for trimming and slotting plastics. Blades are permanently attached to arbors and are not reversible.

Part Number	Cutting DIA	Collar	SHK DIA	Kerf	OAL	Rotation	Price
70-204	1	9/16	1/2	.062	4	Right	\$95.28
70-224	1-1/4	5/8	1/2	.062	4	Right	\$118.20

Usage Hard and soft plastic **Material** **SP** **HP***

70-300



Carbide Tipped Trim Blade Flush Mount

Designed for flush trimming and slotting of both hard and soft plastics. Blades are permanently attached to arbors and are not reversible.

Usage Hard and soft plastic

Material **SP** **HP**

Part Number	Cutting DIA	Teeth	Rake	SHK DIA	Kerf	OAL	Grind	Rotation	Plastic	Feed	Price
70-300	2	10	0°	1/2	.095	4	TCG	RH	Soft	Slow	\$133.16
70-302	2	10	0°	1/2	.095	4	TCG	LH	Soft	Slow	\$133.16
70-320	2	16	0°	1/2	.095	4	TCG	RH	Soft	Fast	\$133.16
70-322	2	16	0°	1/2	.095	4	TCG	LH	Soft	Fast	\$133.16
70-340	2	10	-5°	1/2	.095	4	TCG	RH	Hard	Slow	\$133.16
70-342	2	10	-5°	1/2	.095	4	TCG	LH	Hard	Slow	\$133.16
70-360	2	16	-5°	1/2	.095	4	TCG	RH	Hard	Fast	\$133.16
70-362	2	16	-5°	1/2	.095	4	TCG	LH	Hard	Fast	\$133.16

*SEE FEED & SPEED CHART BELOW

TCG = Triple Chip Grind

ONSRUD STACKED DADO SETS



ONSRUD STACKED DADO SET Includes:
(2) 42T Outside Blades,
(5) 6-wing Chipper Blades,

LIMITED TO STOCK ON HAND!!!

Part #	Diameter	Teeth	Arbor	Chippers	Price
DSET-10-42	10"	42	1"	(5) 6 Tooth	\$229.00

These sets include a Shim Set for micro thin adjustability. Chip free finish in Plywood & Melamine. Always cuts a true flat-bottomed groove. Cuts these materials: Pine, Oak, Plywood, and Melamine.

ONSRUD

HSS Plastic Drill

Designed to produce holes in hard and soft plastic while eliminating edge chipping and chip wrapping.

Usage Hard and soft plastic **Material**  See Selection



- NO Wrapping
- NO Cleaning
- NO Melting
- NO Surface Marring
- NO Interrupted Operation



FRACTIONAL DRILLS

Part Number	Cutting DIA	Flute LGTH	SHK DIA	OAL
70-502	1/8 (0.125)	1-1/2	1/8	2-3/4
70-503	9/64 (0.141)	1-3/4	9/64	2-7/8
70-506	5/32 (0.156)	1-15/16	5/32	3-1/8
70-509	11/64 (0.172)	1-3/4	11/64	3-1/4
70-510	3/16 (0.188)	2-1/8	3/16	3-1/2
70-511	13/64 (0.203)	2-7/16	13/64	3-5/8
70-512	7/32 (0.219)	2-1/2	7/32	3-3/4
70-513	15/64 (0.234)	2-5/8	15/64	3-7/8
70-514	1/4 (0.250)	2-7/16	1/4	4
70-515	17/64 (0.266)	2-7/8	17/64	4-1/8
70-516	9/32 (0.281)	2-15/16	9/32	4-1/4
70-517	19/64 (0.297)	3-1/16	19/64	4-3/8
70-520	5/16 (0.313)	1-3/4	1/4	3-1/8
70-521	21/64 (0.328)	3-5/16	21/64	4-5/8
70-522	11/32 (0.344)	3-7/16	11/32	4-3/4
70-523	23/64 (0.359)	3-1/2	23/64	4-7/8
70-524	3/8 (0.375)	2-1/4	1/4	4-3/8
70-525	25/64 (0.391)	3-3/4	25/64	5-1/8
70-526	13/32 (0.406)	3-7/8	13/32	5-1/8
70-527	27/64 (0.422)	3-15/16	27/64	5-3/8
70-528	7/16 (0.438)	2-1/2	1/4	4-3/4
70-529	29/64 (0.453)	4-3/16	29/64	5-5/8
70-530	15/32 (0.469)	4-5/16	15/32	5-3/4
70-531	31/64 (0.484)	4-3/8	31/64	5-7/8
70-532	1/2 (0.500)	2-5/8	1/4	5-1/8
70-533	33/64 (0.516)	3-1/8	1/2	6
70-534	17/32 (0.531)	3-1/8	1/2	6
70-535	35/64 (0.547)	3-1/8	1/2	6
70-536	9/16 (0.563)	3-1/8	1/2	6
70-537	37/64 (0.578)	3-1/8	1/2	6
70-538	19/32 (0.594)	3-1/8	1/2	6
70-539	39/64 (0.609)	3-1/8	1/2	6
70-540	5/8 (0.625)	3-1/8	1/2	6
70-541	41/64 (0.641)	3-1/8	1/2	6
70-542	21/32 (0.656)	3-1/8	1/2	6
70-543	43/64 (0.672)	3-1/8	1/2	6
70-544	11/16 (0.688)	3-1/8	1/2	6
70-545	45/64 (0.703)	3-1/8	1/2	6
70-546	23/32 (0.719)	3-1/8	1/2	6
70-547	47/64 (0.734)	3-1/8	1/2	6
70-548	3/4 (0.750)	3-1/8	1/2	6
70-549	49/64 (0.766)	3-1/8	1/2	6
70-550	25/32 (0.781)	3-1/8	1/2	6
70-551	51/64 (0.797)	3-1/8	1/2	6
70-552	13/16 (0.813)	3-1/8	1/2	6
70-553	53/64 (0.828)	3-1/8	1/2	6
70-554	27/32 (0.844)	3-1/8	1/2	6
70-555	55/64 (0.859)	3-1/8	1/2	6
70-556	7/8 (0.875)	3-1/8	1/2	6
70-557	57/64 (0.891)	3-1/8	1/2	6
70-558	29/32 (0.906)	3-1/8	1/2	6
70-559	59/64 (0.922)	3-1/8	1/2	6
70-560	15/16 (0.938)	3-1/8	1/2	6

FRACTIONAL DRILLS (CONT.)

Part Number	Cutting DIA	Flute LGTH	SHK DIA	OAL
70-561	61/64 (0.953)	3-1/8	1/2	6
70-562	31/32 (0.969)	3-1/8	1/2	6
70-563	63/64 (0.984)	3-1/8	1/2	6

LETTER DRILLS

Part Number	Cutting DIA	Flute LGTH	SHK DIA	OAL
70-600	A (0.234)	2-5/8	0.234	3-7/8
70-601	B (0.238)	2-3/4	0.238	4
70-602	C (0.242)	2-3/4	0.242	4
70-603	D (0.246)	2-3/4	0.246	4
70-604	E (0.250)	2-3/4	0.250	4
70-605	F (0.257)	2-7/8	0.257	4-1/8
70-606	G (0.261)	2-7/8	0.261	4-1/8
70-607	H (0.266)	2-7/8	0.266	4-1/8
70-608	I (0.272)	2-7/8	0.272	4-1/8
70-609	J (0.277)	2-7/8	0.277	4-1/8
70-610	K (0.281)	2-15/16	0.281	4-1/4
70-611	L (0.291)	2-15/16	0.291	4-1/4
70-612	M (0.295)	3-1/16	0.295	4-3/8
70-613	N (0.302)	3-1/16	0.302	4-3/8
70-614	O (0.316)	3-3/16	0.316	4-1/2
70-615	P (0.323)	3-5/16	0.323	4-5/8
70-616	Q (0.332)	3-7/16	0.332	4-3/4
70-617	R (0.339)	3-7/16	0.339	4-3/4
70-618	S (0.348)	3-1/2	0.348	4-7/8
70-619	T (0.358)	3-1/2	0.358	4-7/8
70-620	U (0.368)	3-5/8	0.368	5
70-621	V (0.377)	3-5/8	0.377	5
70-622	W (0.386)	3-3/4	0.386	5-1/8
70-623	X (0.397)	3-3/4	0.397	5-1/8
70-624	Y (0.404)	3-7/8	0.404	5-1/4
70-625	Z (0.413)	3-15/16	0.413	5-1/4

WIRE DRILLS

Part Number	Cutting DIA	Flute LGTH	SHK DIA	OAL
70-630	1 (0.228)	2-5/8	0.228	3-7/8
70-631	2 (0.221)	2-5/8	0.221	3-7/8
70-632	3 (0.213)	2-1/2	0.213	3-3/4
70-633	4 (0.209)	2-1/2	0.209	3-3/4
70-634	5 (0.206)	2-1/2	0.206	3-3/4
70-635	6 (0.204)	2-1/2	0.204	3-3/4
70-636	7 (0.201)	2-7/16	0.201	3-5/8
70-637	8 (0.199)	2-7/16	0.199	3-5/8
70-638	9 (0.196)	2-7/16	0.196	3-5/8
70-639	10 (0.194)	2-7/16	0.194	3-5/8
70-640	11 (0.191)	2-5/16	0.191	3-1/2
70-641	12 (0.189)	2-5/16	0.189	3-1/2
70-642	13 (0.185)	2-5/16	0.185	3-1/2

WIRE DRILLS

Part Number	Cutting DIA	Flute LGTH	SHK DIA	OAL
70-643	14 (0.182)	2-3/16	0.182	3-3/8
70-644	15 (0.180)	2-3/16	0.180	3-3/8
70-645	16 (0.177)	2-3/16	0.177	3-3/8
70-646	17 (0.173)	2-3/16	0.173	3-3/8
70-647	18 (0.170)	2-1/8	0.170	3-1/4
70-648	19 (0.166)	2-1/8	0.166	3-1/4
70-649	20 (0.161)	2-1/8	0.161	3-1/4
70-650	21 (0.159)	2-1/8	0.159	3-1/4
70-651	22 (0.157)	2	0.157	3-1/8
70-652	23 (0.154)	2	0.154	3-1/8
70-653	24 (0.152)	2	0.152	3-1/8
70-654	25 (0.150)	1-7/8	0.150	3
70-655	26 (0.147)	1-7/8	0.147	3
70-656	27 (0.144)	1-7/8	0.144	3
70-657	28 (0.141)	1-3/4	0.141	2-7/8
70-658	29 (0.136)	1-3/4	0.136	2-7/8
70-659	30 (0.129)	1-5/8	0.129	2-3/4
70-660	31 (0.120)	1-5/8	0.120	2-3/4

METRIC DRILLS

Part Number	Cutting DIA	Flute LGTH	SHK DIA	OAL
70-714	3.00 (0.118)	41	3.00	70
70-715	3.50 (0.138)	44	3.50	73
70-716	4.00 (0.157)	54	4.00	83
70-717	4.50 (0.177)	56	4.50	86
70-718	5.00 (0.197)	62	5.00	92
70-719	5.50 (0.217)	64	5.50	95
70-720	6.00 (0.236)	70	6.00	102
70-721	6.50 (0.256)	73	6.50	105
70-722	7.00 (0.276)	73	7.00	105
70-723	7.50 (0.295)	78	7.50	111
70-724	8.00 (0.315)	81	8.00	114
70-725	8.50 (0.335)	87	8.50	121
70-726	9.00 (0.354)	89	9.00	124
70-727	9.50 (0.374)	92	9.50	127
70-728	10.00 (0.394)	95	10.00	130
70-729	10.50 (0.413)	98	10.50	133
70-730	11.00 (0.433)	103	11.00	140
70-731	11.50 (0.453)	106	11.50	143
70-732	12.00 (0.472)	111	12.00	149
70-733	12.50 (0.492)	114	12.50	152
70-734	13.00 (0.512)	114	13.00	152
70-735	13.50 (0.531)	122	13.50	168
70-736	14.00 (0.551)	122	14.00	168
70-737	14.50 (0.571)	122	14.50	168
70-738	15.00 (0.591)	132	15.00	181
70-739	15.50 (0.610)	132	15.50	181
70-740	16.00 (0.630)	132	16.00	181
70-741	16.50 (0.650)	132	16.50	181
70-742	17.00 (0.669)	143	17.00	194
70-743	17.50 (0.689)	143	17.50	194

Call for pricing.

72-000



Through Hole **Brad Point**



Hinge

Solid Carbide Boring Bits

Two style of tools are available in this series. The brad point drill is designed to cut blind holes and produce a clean edge on the top surface. The 60° through drill is designed to produce through holes while providing clean edges on both sides.

BRAD POINT - designed to produce a blind hole while preventing fraying on the top edge.

RIGHT HAND ROTATION

Part Number	Cutting DIA	SHK DIA	OAL	Part Number	Cutting DIA	SHK DIA	OAL
72-001	3	10	57	72-021	3	10	70
72-005	5	10	57	72-025	5	10	70
72-009	6	10	57	72-029	6	10	70
72-013	8	10	57	72-033	8	10	70

LEFT HAND ROTATION

Part Number	Cutting DIA	SHK DIA	OAL	Part Number	Cutting DIA	SHK DIA	OAL
72-002	3	10	57	72-022	3	10	70
72-006	5	10	57	72-026	5	10	70
72-010	6	10	57	72-030	6	10	70
72-014	8	10	57	72-034	8	10	70

HINGE BIT - This 35mm carbide tipped bit is designed to produce a flat bottom hole with clean edges for hinge mounting.

Usage Wood

Material



See Selection Guide - pg. 2 - 12

THROUGH HOLE (60° POINT) - produces a through hole and reduces fraying on the entry and exit edges.

RIGHT HAND ROTATION

Call for pricing.

Part Number	Cutting DIA	SHK DIA	OAL	Part Number	Cutting DIA	SHK DIA	OAL
72-053	3	10	57	72-075	3	10	70
72-057	5	10	57	72-079	5	10	70
72-061	6	10	57	72-083	6	10	70
72-065	8	10	57	72-087	8	10	70

LEFT HAND ROTATION

Part Number	Cutting DIA	SHK DIA	OAL	Part Number	Cutting DIA	SHK DIA	OAL
72-054	3	10	57	72-076	3	10	70
72-058	5	10	57	72-080	5	10	70
72-062	6	10	57	72-084	6	10	70
72-066	8	10	57	72-088	8	10	70

Part Number	Cutting DIA	SHK DIA	OAL	Price
72-097	35	10	70	\$46.00

77-100



Double or Three Flute Solid Carbide Taper Tools

The taper tools are available with a variety of taper angles and come standard with a ball nose point. The tools are designed to produce a good edge finish in a wide variety of materials.

Usage Wood, plastic and aluminum

Material SW HW SP HP A

Part Number	Cutting DIA	Flute LGTH	SHK DIA	OAL	Angle Per Side	Radius	Flutes	Price
77-102	1/8	1-1/2	1/4	3	1°	1/16	3	\$61.12
77-104		1	1/4	3	3°	1/16	3	\$52.96
77-106	1/8 ^{1/8}	3/4	1/4	3	5°	1/16	3	\$50.96
77-108	1/8	1/2	1/4	3	7°	1/16	3	\$48.88
77-112	1/4	2	1/2	4	3°	1/8	2	\$116.20
77-114	1/4	1-3/8	1/2	4	5°	1/8	2	\$114.12
77-116	1/4	1	1/2	4	7°	1/8	2	\$112.00

METRIC

Part Number	Cutting DIA	Flute LGTH	SHK DIA	OAL	Angle Per Side	Radius	Flutes	Price
77-102M	3mm	39mm	6mm	76mm	1°	1.5mm	3	\$54.48
77-104M	3mm	25mm	6mm	76mm	3°	1.5mm	3	\$47.76
77-106M	3mm	19mm	6mm	76mm	5°	1.5mm	3	\$46.12
77-108M	3mm	12mm	6mm	76mm	7°	1.5mm	3	\$44.44
77-112M	6mm	50mm	12mm	100mm	3°	3mm	2	\$72.16
77-114M	6mm	35mm	12mm	100mm	5°	3mm	2	\$70.48
77-116M	6mm	25mm	12mm	100mm	7°	3mm	2	\$68.80

ONSRUD

Three Flute - High Speed Steel Taper Pin Router

These three flute upcuts with a tapered flute are used for profiling and trimming primarily in aircraft assembly operations.

Usage Aluminum

Material 

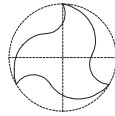

Part Number	Cutting DIA	Flute LGTH	SHK DIA	OAL	Price
80-001	.098	3/4	.098	2	\$4.08
80-002	.110	7/8	.128	2 1/4	\$4.08
80-003	.165	1 1/16	.1875	2 1/2	\$7.36

HELIX ANGLE = 24°



81-000



Double Flute - High Speed Steel Lo Helix

These lo helix upcut spirals were developed for CNC routers used primarily in the aircraft industry. They are designed with maximum strength of configuration to cut T, O or combined stacks of aluminum-using coolant.

Usage Aluminum **Material** 

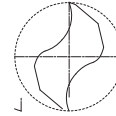

Part Number	Cutting DIA	Flute LGTH	SHK DIA	OAL	Helix	ALUM Condition	Price
81-001	1/4	3/4	1/2	3 1/16	5°	T	\$23.04
81-003	5/16	3/4	1/2	3 1/16	10°	C	\$23.72
81-004	5/16	3/4	1/2	3 1/16	10°	O	\$25.68

Double Flute - Solid Carbide Spiral Extrusion Cutters

81-100



Designed for reduced vibration producing smoother finish cuts. Extended reach during side thinning and gage reduction. Longer tool life to reduce tool changes.

Usage Extrusion and sheet aluminum. Optimized for use on multi-head extrusion mills CNC mills and routers

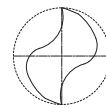

Material 

Part Number	Cutting DIA	Flute LGTH	ERL	SHK DIA	OAL	Helix & DIR	Flutes	CNR RAD Chamfer	Aluminum Condition	Machining Environment	Price
Tolerance	+0.02	±.03		+0.000 -0.005	±.03						
81-103	5/16	13/16	-	1/2	3	10°RH	2	.02 x 45°	C	Wet	\$93.48
81-104	3/8	13/16	-	1/2	3	10°RH	2	.02 x 45°	O	Wet	\$100.48

ONSRUD

Solid Carbide CFRP Drill (Coated)

The CFRP drill is designed to ensure hole quality and diameter. The “W” point of the drill centers the drill to let the peripheral cutting edges shear the material producing a clean, tight tolerance hole without fraying or delamination. The drills are coated with a Diamond Like Carbon (DLC).

Usage Carbon Fiber Reinforced Plastics, Kevlar® and Composites

Material  CP

85-800

NEW

FRACTIONAL DRILLS

Part Number	Cutting DIA	Flute LGTH	SHK DIA	OAL
85-807	1/8 (0.1250)	0.500	1/8	3
85-808	9/64 (0.1406)	0.500	3/16	3
85-809	5/32 (0.1563)	0.500	3/16	3
85-810	11/64 (0.1719)	0.500	3/16	3
85-811	3/16 (0.1875)	0.500	3/16	3
85-812	13/64 (0.2031)	0.500	1/4	3
85-813	7/32 (0.2188)	0.500	1/4	3
85-814	15/64 (0.2344)	0.500	1/4	3
85-815	1/4 (0.2500)	0.500	1/4	3
85-816	17/64 (0.2656)	0.500	5/16	3
85-817	9/32 (0.2813)	0.500	5/16	3
85-818	19/64 (0.2969)	0.500	5/16	3
85-819	5/16 (0.3125)	0.500	5/16	3
85-820	21/64 (0.3281)	0.500	3/8	3
85-821	11/32 (0.3438)	0.500	3/8	3
85-822	23/64 (0.3594)	0.500	3/8	3
85-823	3/8 (0.3750)	0.500	3/8	3
85-827	7/16 (0.4375)	0.500	7/16	3
85-831	1/2 (0.5000)	0.500	1/2	3

METRIC DRILLS

Part Number	Cutting DIA	Flute LGTH	SHK DIA	OAL
85-961	3.00 (0.1181)	12.000	3	76
85-963	4.00 (0.1575)	12.000	4	76
85-965	5.00 (0.1969)	12.000	5	76
85-967	6.00 (0.2362)	12.000	6	76
85-971	8.00 (0.3150)	12.000	8	76
85-975	10.00 (0.3937)	12.000	10	76
85-979	12.00 (0.4724)	12.000	12	76

NUMBER DRILLS

Part Number	Cutting DIA	Flute LGTH	SHK DIA	OAL
85-876	1 (0.2280)	0.500	1/4	3
85-877	2 (0.2210)	0.500	1/4	3
85-878	3 (0.2130)	0.500	1/4	3
85-879	4 (0.2090)	0.500	1/4	3
85-880	5 (0.2055)	0.500	1/4	3
85-881	6 (0.2040)	0.500	1/4	3
85-882	7 (0.2010)	0.500	1/4	3
85-883	8 (0.1990)	0.500	1/4	3
85-884	9 (0.1960)	0.500	1/4	3
85-885	10 (0.1935)	0.500	1/4	3
85-886	11 (0.1910)	0.500	1/4	3
85-887	12 (0.1890)	0.500	1/4	3
85-888	13 (0.1850)	0.500	3/16	3
85-889	14 (0.1820)	0.500	3/16	3
85-890	15 (0.1800)	0.500	3/16	3
85-891	16 (0.1770)	0.500	3/16	3
85-892	17 (0.1730)	0.500	3/16	3
85-893	18 (0.1695)	0.500	3/16	3
85-894	19 (0.1660)	0.500	3/16	3
85-895	20 (0.1610)	0.500	3/16	3
85-896	21 (0.1590)	0.500	3/16	3

NUMBER DRILLS (CONT.)

Part Number	Cutting DIA	Flute LGTH	SHK DIA	OAL
85-897	22 (0.1570)	0.500	3/16	3
85-898	23 (0.1540)	0.500	5/32	3
85-899	24 (0.1520)	0.500	5/32	3
85-900	25 (0.1495)	0.500	5/32	3
85-901	26 (0.1470)	0.500	5/32	3
85-902	27 (0.1440)	0.500	5/32	3
85-903	28 (0.1405)	0.500	5/32	3
85-904	29 (0.1360)	0.500	5/32	3
85-905	30 (0.1285)	0.500	5/32	3
85-906	31 (0.1200)	0.500	1/8	2-1/2
85-907	32 (0.1160)	0.500	1/8	2-1/2
85-908	33 (0.1130)	0.500	1/8	2-1/2
85-909	34 (0.1110)	0.500	1/8	2-1/2
85-910	35 (0.1100)	0.500	1/8	2-1/2
85-911	36 (0.1065)	0.500	1/8	2-1/2
85-912	37 (0.1040)	0.500	1/8	2-1/2
85-913	38 (0.1015)	0.500	1/8	2-1/2
85-914	39 (0.0995)	0.500	1/8	2-1/2
85-915	40 (0.0980)	0.500	1/8	2-1/2
85-916	41 (0.0960)	0.500	1/8	2-1/2

Call for pricing

83-300



ONSRUD
Double Flute - Solid Carbide AlTiN Coated
Upcut Spiral for Stainless Steel

Special cutting geometry is required to cut stainless steel and achieve decent tool life. Onsrud has developed a line of cutters which are capable of cutting stainless steel.

Usage Stainless Steel

Material

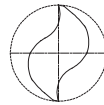

Part Number	Cutting DIA	Flute LGTH	SHK DIA	OAL	Price
83-305AlTiN	1/8	1/4	1/8	2	\$25.52
83-310AlTiN	3/16	3/8	3/16	2-1/2	\$35.36
83-315AlTiN	1/4	3/8	1/4	2-1/2	\$36.80
83-320AlTiN	3/8	1/2	3/8	3	\$52.00

CUTTING PARAMETERS

Part Number	RPM	Feedrate	Depth of Cut
83-305AlTiN	18,000	18 IPM	.012
83-310AlTiN	12,000	20 IPM	.020
83-315AlTiN	9,000	25 IPM	.030
83-320AlTiN	6,010	27 IPM	.045

86-100



Diamond Film Coated Solid Carbide Parabolic Drill

Designed to produce a clean, delamination free hole in composite materials. The diamond film coated (CVD) parabolic drill is an economical solution to PCD composite drills.

Usage Carbon fiber and other composite materials

Material

Part Number	Cutting DIA	Flute LGTH	SHK DIA	OAL	Price
86-102	0.100	1	1/4	3	\$128.56
86-106	0.129	1	1/4	3	\$134.72
86-110	0.147	1	1/4	3	\$164.72
86-114	0.192	1	1/4	3	\$194.16
86-118	0.251	1	1/4	3	\$194.16
86-122	0.313	1	5/16	3	\$235.36
86-126	0.376	1	3/8	3	\$281.64
86-130	0.502	1	1/2	3	\$350.60

91-000
91-100



Insert Style



Carbide Tipped

Spoilboard Surfacing Cutters

Designed for surfacing MDF, particleboard and balsa core where “flow through” or “high flow” fixturing is employed using large capacity vacuum pumps. This method of surfacing spoilboards allows for much faster table planing.

Usage Aluminum, plastics and composite wood

Material

STRAIGHT

Part Number	Cutting DIA	SHK DIA	SHK LGTH	# of Wings	Price
91-000*	1-1/4	1/2	1-1/2	2	\$37.12
91-102	2-1/2	1/2	2	2	\$315.84
91-106	4	3/4	2-1/4	3	\$349.32

UP-SHEAR

Part Number	Cutting DIA	SHK DIA	SHK LGTH	# of Wings	Price
91-104	2-1/2	1/2	2	2	\$367.48
91-108	4	3/4	2-1/4	3	\$411.80
91-112*	2-1/2	1/2	2	3	\$381.52
91-114*	4	3/4	2-1/4	3	\$425.92

* = Carbide Tipped
 Note: 90-002, 90-004, 90-006 & 90-008 use 91-125 insert and 91-130 screw
 90-014 use 91-127 insert and 91-130 screw

* Radius edges excellent for plastic and aluminum surfacing.

These tools are dynamically balanced and approved for use on CNC routers. Max RPM 18,000 1/8" Depth of cut MAX.

** DOC = Maximum Depth of Cut Proper running speed for*

Spoilboard Surfaces: 2-1/2" diameter tools should be fed at 200-600 IPM at 12,000-16,000 RPM. 4" diameter tools should be fed at 200-600 IPM at 12,000-14,000 RPM.

** Do Not Exceed 1/8" Depth Per Pass*

Part Number	Description	Price
91-125	Insert 10/pk	\$45.08
91-127	Radius Insert 10/pk	\$101.48
91-130	Screw M4 (Old Version)	\$2.76
91-133	Screw M5	\$2.76
91-136	Wrench	\$10.52

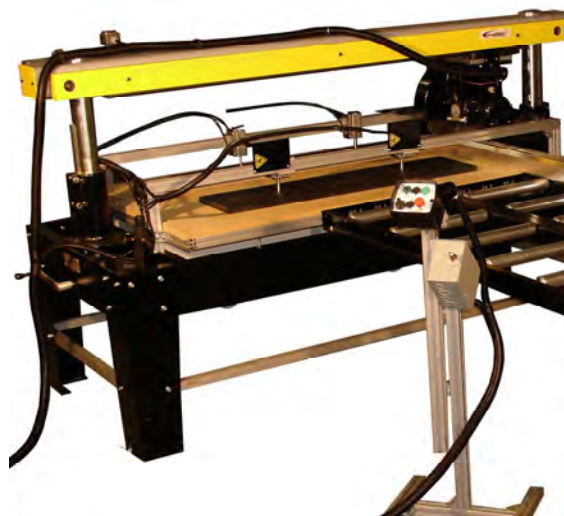



Panasonic

EY6432NQKW 15.6-Volt NiMH 1/2-Inch Cordless Drill/Driver Kit

Delivers 390-inches-per-pound of torque for big applications
 1/2-inch keyless chuck handles larger bits
 45-minute charge saves time
 Compact and lightweight for all-day use

+Batteries

\$192.00

High Power, Small Size

At 4.5 lbs. including battery, and only 8-3/16" long x 9" tall x 2-9/32" wide, this cordless drill and driver produces up to 390 in. lbs. of power for demanding drilling jobs, yet its small size makes it a good tool for work in cramped quarters.

Features, Benefits and Applications

Variable speed control and a reversible two-speed transmission delivers 65-450 rpm on low speed and 200-1,450 rpm in high speed. This power drill comes equipped with an 18-stage clutch and a laser-welded, fan cooled motor delivers 9 to 61 in. lbs. stepped up in 3.0 in. lbs. increments and delivers 390/in torque with dual speed range 65-450/200-1450.

Ni-MH 2.8 amp Nickel Metal Hydride Battery Technology

Using the Panasonic EY0110B charger, this battery powered drill reaches full charge in 45 minutes producing 50-percent more run time per charge and is the highest capacity battery on the market today for cordless drills. .

This power drill's ergonomic design and rubberized grip fits well in the user's hand and helps maintain a neutral wrist position in overhead, horizontal or floor drilling/driving operations reducing operator fatigue. The electric brake stops the bit from turning instantly when the trigger is released for optimal drilling and driving control.

Popular Tools
Panel Saws



To keep material from chipping at the bottom, use a main blade and a scoring blade, held in precise alignment to each other and turning in opposite directions. The lower surface is scored, cut by the smaller scoring blade ahead of the larger main blade that completes the cut. The outer surface of the material has already been cut and cannot chip.

With each sharpening, the main blade becomes shorter and narrower. The scoring blades must cut a kerf of the same width as the main blade kerf (blade is re-sharpened only on the face to maintain the constant kerf).

Consequently, the scoring saw kerf has to be altered. The conic scoring saw, when first put in use, cuts a deeper groove to match the wide main blade. As the main saw becomes narrower, the scoring saw must cut shallower (narrower) to match the main saw.

Most often, the main and scoring saws are purchased as a set and kept together for their entire useful lives. For split scoring saws, the need to match the kerf to that of a main saw remains the same, though the mechanics are different. Spacers (shims) are added to make it as wide as the new main saw. As the main saw becomes narrower with the repeated sharpening, spacers are removed from the scoring saw to keep it at the width of the main saw.

Designed for use on panel machines for cutting MDF, particle board, laminates, and bonded materials.

All panel saws have a 15 degree hook angle.

DIAMETER	TEETH	BORE & PINHOLE	KERF	PLATE	DESIGN	ORDER ID	PRICE
300 mm	60T	30, 2/7/42 + 2/10/60	4.4	3.2 mm	TCG	PS3003060T	\$ 142.40
300 mm	60T	80, 2/14/110 + 4/9/100 + 2/7/110	4.4	3.2 mm	TCG	PS3008060T	\$ 142.40
300 mm	72T	30, 2/7/42 + 2/10/60	3.2	2.2 mm	ATB	GAM3003072	\$ 85.00
300 mm	72T	65, 2/9/110	4.4	3.2 mm	TCG	PS3006572T	\$ 145.60
300 mm	72T	75	4.4	3.2 mm	TCG	PS3007572T	\$ 145.60
300 mm	96T	30, 2/7/42 + 2/10/60	3.2	2.2 mm	ATB	GAM3003096	\$ 97.00
320 mm	72T	50, 3/12.5/80	4.4	3.2 mm	TCG	PS3205072T	\$ 148.20
320 mm	72T	65, 2/9/110	4.4	3.2 mm	TCG	PS3206572T	\$ 148.20
350 mm	54T	30, 2/10/60	4.4	3.2 mm	ATB	PS3503054A	\$ 136.60
350 mm	54T	30, 2/10/60	4.4	3.2 mm	TCG	PS3503054T	\$ 140.80
350 mm	54T	75	4.4	3.2 mm	ATB	PS3507554A	\$ 136.60
350 mm	72T	30, 2/10/60	4.4	3.2 mm	ATB	PS3503072A	\$ 145.60
350 mm	72T	30, 2/10/60	4.4	3.2 mm	TCG	PS3503072T	\$ 152.00
350 mm	72T	50, 4/12.5/80	4.4	3.2 mm	TCG	PS3505072T	\$ 163.60
350 mm	72T	60, 2/14/100	4.4	3.2 mm	TCG	PS3506072T	\$ 152.00
350 mm	72T	75	4.4	3.2 mm	TCG	PS3507572T	\$ 156.00
350 mm	72T	80, 4/9/100 + 2/7/110 + 2/14/110	4.4	3.2 mm	TCG	PS3508072T	\$ 152.00
350 mm	72T	1 1/4"	4.4	3.2 mm	TCG	PS350Q72T	\$ 152.00
370 mm	72T	30, 2/10/60	4.4	3.2 mm	TCG	PS3703072T	\$ 186.00
380 mm	60T	60, 2/14/100	4.4	3.2 mm	TCG	PS3806060T	\$ 183.60
380 mm	72T	30, 2/14/100	4.4	3.2 mm	TCG	PS3803072T	\$ 193.20
380 mm	72T	50, 4/12.5/80	4.4	3.2 mm	TCG	PS3805072T	\$ 186.00
380 mm	72T	60, 2/14/100	4.4	3.2 mm	TCG	PS3806072T	\$ 186.00
380 mm	72T	60, 2/14/100	4.8	3.5 mm	TCG	PS3806072TB	\$ 201.40
380 mm	72T	65, 2/9/110	4.4	3.2 mm	TCG	PS3806572T	\$ 180.60
380 mm	72T	80, 2/14/110	4.4	3.2 mm	TCG	PS3808072T	\$ 186.00
400 mm	60T	75, 4/15/105	4.4	3.2 mm	TCG	PS4007560T	\$ 187.80
400 mm	60T	80, 2/9/130 + 4/19/120	4.4	3.2 mm	TCG	PS4008060T	\$ 197.20
400 mm	72T	30	4.4	3.2 mm	TCG	PS4003072T	\$ 194.00
400 mm	72T	60, 2/11/115	4.4	3.2 mm	TCG	PS4006072T	\$ 194.00
400 mm	72T	80, 4/9/100 + 2/7/110 + 2/14/110	4.4	3.2 mm	TCG	PS4008072T	\$ 194.00
420 mm	72T	60, 2/11/115	4.8	3.4 mm	TCG	PS4206072T	\$ 227.20
430 mm	60T	75, 4/15/105	4.8	3.5 mm	TCG	PS4307560T	\$ 227.20
430 mm	72T	75, 4/15/105	4.8	3.5 mm	TCG	PS4307572T	\$ 227.20
430 mm	72T	80, 2/9/130 + 4/19/120	4.4	3.2 mm	ATB	PS4308072A	\$ 204.80
430 mm	72T	80, 2/9/130 + 4/19/120	4.4	3.2 mm	TCG	PS4308072T	\$ 204.80
450 mm	72T	30	4.4	3.2 mm	TCG	PS4503072T	\$ 227.20
450 mm	72T	60, 2/14/125	4.8	3.5 mm	TCG	PS4506072T	\$ 237.60
450 mm	72T	80, 2/9/130 + 4/9/120	4.4	3.2 mm	ATB	PS4508072A	\$ 204.80
450 mm	72T	80, 2/9/130 + 4/9/120	4.4	3.2 mm	TCG	PS4508072T	\$ 204.80

Popular Tools
Panel Saws



To keep material from chipping at the bottom, use a main blade and a scoring blade, held in precise alignment to each other and turning in opposite directions. The lower surface is scored, cut by the smaller scoring blade ahead of the larger main blade that completes the cut. The outer surface of the material has already been cut and cannot chip.

With each sharpening, the main blade becomes shorter and narrower. The scoring blades must cut a kerf of the same width as the main blade kerf (blade is re-sharpened only on the face to maintain the constant kerf).

Consequently, the scoring saw kerf has to be altered. The conic scoring saw, when first put in use, cuts a deeper groove to match the wide main blade. As the main saw becomes narrower, the scoring saw must cut shallower (narrower) to match the main saw.

Most often, the main and scoring saws are purchased as a set and kept together for their entire useful lives. For split scoring saws, the need to match the kerf to that of a main saw remains the same, though the mechanics are different. Spacers (shims) are added to make it as wide as the new main saw. As the main saw becomes narrower with the repeated sharpening, spacers are removed from the scoring saw to keep it at the width of the main saw.

Designed for use on panel machines for cutting MDF, particle board, laminates, and bonded materials.

All panel saws have a 15 degree hook angle.

Panel Saws Continued

DIAMETER	TEETH	BORE & PINHOLE	KERF	PLATE	DESIGN	ORDER ID	PRICE
460	72T	30, 2/13/94	4.4	3.2 mm	TCG	PS4603072T	\$ 218.40
470	72T	75, 4/15/105	4.4	3.2 mm	TCG	PS4707572T	\$ 224.00
480	60T	30	4.4	3.2 mm	TCG	PS4803060T	\$ 204.80
480	72T	30	4.4	3.2 mm	TCG	PS4803072T	\$ 218.40
480	72T	80, 2/9/130 + 4/19/120	4.8	3.5 mm	TCG	PS4808072T	\$ 218.40
500	60T	30	4.4	3.2 mm	TCG	PS5003060T	\$ 256.40
500	72T	60, 2/11/115 + 2/19/120	5	3.5 mm	TCG	PS5006072T	\$ 263.80
500	72T	75, 2/11/115 + 2/19/120	5	3.5 mm	TCG	PS5007572T	\$ 263.80
500	72T	80, 2/9/110	5	3.5 mm	TCG	PS5008072T	\$ 253.00
520	60T	60, 2/11/115 + 2/19/120	4.8	3.5 mm	TCG	PS5206060T	\$ 241.40
530	60T	30	5	3.5 mm	TCG	PS5303060T	\$ 254.60
540	60T	60, 2/11/115 + 2/19/120	5	3.5 mm	TCG	PS5406060T	\$ 273.00
540	84T	60, 2/11/115 + 2/19/120	5	3.5 mm	TCG	PS5406084T	\$ 303.80
550	72T	100	5	3.5 mm	TCG	PS5501072TG	\$ 282.20
570	60T	60, 2/19/120+2/11/115	5	3.5 mm	TCG	PS5706060T	\$ 287.20
600	60T	60, 2/11/115 + 2/19/120	5.8	4. mm	TCG	PS6006060T	\$ 384.40
600	72T	60, 2/11/115 + 2/19/120	5.8	4. mm	TCG	PS6006072T	\$ 412.00
670	60T	40, 1/11/140	6.2	4.2 mm	TCG	PS6704060T	\$ 476.00
670	60T	60, 2/11/148 + 2/19/120	6.2	4.2 mm	TCG	PS6706060T	\$ 476.00

The NPS series Panel Saws

Designed to run longer and give extended performance when it counts. The NPS series Panel Saw Blades come with larger, stronger carbide tips designed to combat the abrasive glues and binding elements in MDF, laminates, particle boards, etc. In addition to the new tips, our saw plates are held to strict tolerances keeping the saw bodies extremely flat which makes the saws run truer.

(More sizes to be added. Call us if what you need is not listed).

All panel saws have a 15 degree hook.

DIAMETER	TEETH	BORE & PINHOLE mm	KERF	PLATE	DESIGN	ORDER ID	PRICE
300mm	72T	75	4.4 mm	3.2 mm	TCG	NPS3007572TN	\$ 162.80
350mm	54T	30, 2/10/60	4.4 mm	3.2 mm	TCG	NPS3503054TN	\$ 156.00
350mm	72T	75	4.4 mm	3.2 mm	TCG	NPS3507572TN	\$ 174.80
380mm	72T	60, 2/14/100	4.8 mm	3.5 mm	TCG	NPS3806072TBN	\$ 223.00
400mm	72T	30	4.4 mm	3.2 mm	TCG	NPS4003072TN	\$ 208.00
400mm	72T	80, 2/9/130, 4/19/120	4.4 mm	3.2 mm	TCG	NPS4008072TN	\$ 213.00
430mm	72T	80, 2/19/130, 4/19.120	4.4 mm	3.2 mm	TCG	NPS4308072TN	\$ 283.00
430mm	92T	75, 4/15/105	4.4 mm	3.2 mm	TCG	NPS4307596TN	\$ 283.00
460mm	72T	30, 2/13/94	4.4 mm	3.2 mm	TCG	NPS4603072TN	\$ 299.60
540mm	84T	60, 2/11/115, 2/19/120	5. mm	3.5 mm	TCG	NPS5406084TN	\$ 374.40
600mm	60T	60, 2/11/115, 2/19/120	5.8 mm	4. mm	TCG	NPS6006060TN	\$ 422.80

Popular Tools **Conic Scoring Saws (made with a 10 degree hook)**
Panel Saws

Conic tooth shape allows for the saw to match the kerf of the main blade simply by adjusting the height of the scoring blade.



SC1804530F



Conic Tip

To keep material from chipping at the bottom, use a main blade and a scoring blade, held in precise alignment to each other and turning in opposite directions. The lower surface is scored, cut by the smaller scoring blade ahead of the larger main blade that completes the cut. The outer surface of the material has already been cut and cannot chip.

DIAMETER	TEETH	BORE mm	KERF mm	PLATE	DESIGN	ORDER ID	PRICE
120 mm	24T	20	3.2-4.2	2.2 mm	RA	SC1202024T	\$ 79.20
120 mm	24T	20	4.4-5.4	3.2 mm	RA	SC1202024F	\$ 81.60
125 mm	24T	20	4.4-5.4	3.2 mm	RA	SC1252024	\$ 83.20
125 mm	24T	45	4.4-5.4	3.2 mm	RA	SC1254524	\$ 98.60
150 mm	24T	30	4.4-5.2	3.2 mm	RA	SC1503024T	\$ 108.20
150 mm	24T	1 1/4"	4.4-5.4	3.2 mm	RA	SC150Q24	\$ 108.20
150 mm	24T	45	4.4-5.4	3.2 mm	RA	SC1504524	\$ 108.20
160 mm	36T	45, 3/11/70	4.4-5.4	3.2 mm	RA	SC1604536	\$ 135.20
160 mm	36T	55, 3/7/66	4.4-5.4	3.2 mm	RA	SC1605536	\$ 128.60
175 mm	28T	45, 2/11/115	4.4-5.4	3.2 mm	RA	SC1754528	\$ 128.60
180 mm	30T	45	4.4-5.4	3.2 mm	RA	SC1804530F	\$ 138.20
180 mm	30T	50, 3/12.5/80	4.4-5.4	3.2 mm	RA	SC180503044	\$ 134.40
180 mm	34T	20, 2/7/42+2/10/60	4.4-5.4	3.2 mm	RA	SC1802034	\$ 139.00
180 mm	34T	30, 2/7/42+2/10/60	4.4-5.4	3.2 mm	RA	SC1803034	\$ 139.00
180 mm	36T	45	4.8-5.8	3.2 mm	RA	SC1804536H	\$ 139.00
180 mm	36T	50, 3/13/80	4.4-5.4	3.2 mm	RA	SC1805036	\$ 144.80
180 mm	36T	55	5.0-6.0	3.2 mm	RA	SC1805536G	\$ 138.20
200 mm	34T	20	4.4-5.4	3.2 mm	RA	SC2002034F	\$ 128.60
200 mm	34T	20, 2/11/115	5.0-6.0	3.2 mm	RA	SC2002034S	\$ 134.40
200 mm	34T	45, 2/11/115	4.4-5.4	3.2 mm	RA	SC2004534T	\$ 128.60
200 mm	34T	45, 2/11/115	4.8-5.8	3.2 mm	RA	SC2004534E	\$ 128.60
200 mm	34T	45, 2/11/115	5.0-6.0	3.2 mm	RA	SC2004534J	\$ 134.40
200 mm	34T	45, 2/11/115	5.8-6.8	3.2 mm	RA	SC2004534S	\$ 142.40
200 mm	34T	65, 2/9/110+2/9/100	4.4-5.2	3.2 mm	RA	SC2006534	\$ 128.60
200 mm	36T	20	6.2-7.2	3.4 mm	RA	SC2002062	\$ 153.60
200 mm	36T	45	5.8-6.8	3.2 mm	RA	SC2004536H	\$ 142.40
200 mm	36T	45	6.2-7.2	3.4 mm	RA	SC2004562	\$ 153.60
200 mm	36T	65, 2/9/110+2/9/100	4.8-5.8	3.2 mm	RA	SC2006536	\$ 142.40
200 mm	36T	80, 2/14/110	4.4-5.4	3.2 mm	RA	SC2008036	\$ 142.40
215 mm	42T	50, 3/15/80	4.8-5.8	3.2 mm	RA	SC2155042	\$ 161.00
215 mm	24T	50, 3/15/80	4.4-5.4	3.2 mm	RA	SC215504244	\$ 161.00

Split Scoring Saws (All have 10 degree hook angle)

Split design allows adjustment to match kerf of main blade simply by adding shims.

Split Scoring Saws



SS12020

DIAMETER mm	TEETH	BORE mm	KERF mm	PLATE mm	DESIGN	ORDER ID	PRICE
100	2x12	3/4"	2.8-3.6	2	Split , FTG	SS100Q	\$ 112.40
100	2x12	20	2.8-3.6	2	Split, FTG	SS10020	\$ 112.40
100	2x12	22	2.8-3.6	2	Split , FTG	SS10022	\$ 112.40
120	2x12	3/4"	2.8-3.6	2	Split, FTG	SS120Q	\$ 112.40
120	2x12	20	2.8-3.6	2	Split , FTG	SS12020	\$ 112.40
120	2x12	22	2.8-3.6	2	Split, FTG	SS12022	\$ 112.40
120	2x12	30	1.9mm	2	Split, FTG	SSE 12030	\$ 117.40
120	2x12	50	2.8-3.6	2	Split, FTG	SSRP12050	\$ 112.40

Popular Tools
Nail Biting Saws



NL1430

Our nail biting blades are specially designed to cut woods that have hard to cut materials in them such as nails and metal staples. They are great for pallet recyclers or any other company recycling woods.

DIAMETER	TEETH	DESIGN	KERF	PLATE	BORE & PINS	ORDER ID	PRICE
12"	28T	UNI-TCG	.180"	.118"	1"	NL1228	\$ 106.20
14"	30T	UNI-TCG	.180"	.118"	1"	NL1430	\$ 120.00
16"	30T	UNI-TCG	.185"	.134"	1"	NL1630	\$ 133.60
18"	36T	UNI-TCG	.185"	.134"	1"	NL1836	\$ 171.40

Popular Tools
Edge Banders



EB10020A

Designed to trim plastic protective edge bandings of solid wood, wood veneers and plastic. For use on single and double-side edge banding machines.

DIAMETER	TEETH	DESIGN	KERF	PLATE	BORE	HOOK	ORDER ID	PRICE
100mm	20T	ATB	3.0mm	2.0mm	20mm	5	EB10020A	\$ 42.20
100mm	20T	Left	3.0mm	2.0mm	20mm	5	EB1002020L	\$ 42.20
100mm	20T	Right	3.0mm	2.0mm	20mm	5	EB1002020R	\$ 42.20
100mm	20T	ATB	3.0mm	2.0mm	32mm	5	EB10032A	\$ 42.20
100mm	20T	Left	3.0mm	2.0mm	32mm	5	EB1003220L	\$ 42.20
100mm	20T	Right	3.0mm	2.0mm	32mm	5	EB1003220R	\$ 42.20
110mm	20T	ATB	3.6mm	2.6mm	22mm	5	EB1102220A	\$ 42.20
120mm	24T	ATB	3.2mm	2.2mm	20mm	5	EB1202024A	\$ 46.20
125mm	40T	Left	3.2mm	2.2mm	20mm	5	EB1252040L	\$ 52.60
125mm	40T	Right	3.2mm	2.2mm	20mm	5	EB1252040R	\$ 52.60
150mm	30T	Left	3.5mm	2.3mm	22mm	5	EB1502230L	\$ 54.20
150mm	30T	Right	3.5mm	2.3mm	22mm	5	EB1502230R	\$ 54.20
160mm	48T	Left	3.2mm	2.2mm	20mm	5	EB1602048L	\$ 61.60
160mm	48T	Right	3.2mm	2.2mm	20mm	5	EB1602048R	\$ 61.60
170mm	48T	Left	3.2mm	2.2mm	20mm	5	EB1702048L	\$ 61.60
170mm	48T	Right	3.2mm	2.2mm	20mm	5	EB1702048R	\$ 61.60
180mm	48T	ATB	3.2mm	2.2mm	20mm	5	EB1802048A	\$ 66.20
100mm	24T	Left	3.6mm	2.2mm	1"	15	VORW10024L*	\$ 89.20
100mm	24T	Right	3.6mm	2.2mm	1"	15	VORW10024R*	\$ 89.20

Popular Tools
Combination Saws



CR1050

Designed for all-around use when acceptable rips and crosscuts must be made with one saw blade. The larger gullets allow for deeper cuts and efficient saw dust escape on rip cuts.

DIAMETER	TEETH	DESIGN	KERF	PLATE	BORE	HOOK	ORDER ID	PRICE
7"	40T	ATB+R	.126"	.087"	5/8"	15	CR740	\$ 59.20
8"	40T	ATB+R	.126"	.087"	5/8"	15	CR840	\$ 68.80
9"	40T	ATB+R	.126"	.087"	5/8"	15	CR940	\$ 68.80
10"	40T	ATB+R	.126"	.087"	5/8"	15	CR1040	\$ 66.20
10"	50T	ATB+R	.126"	.087"	5/8"	15	CR1050	\$ 66.20
12"	50T	ATB+R	.134"	.094"	1"	15	CR1250	\$ 108.20
12"	60T	ATB+R	.134"	.094"	1"	15	CR1260	\$ 115.80
14"	60T	ATB+R	.160"	.110"	1"	15	CR1460	\$ 132.80
14"	70T	ATB+R	.160"	.110"	1"	15	CR1470	\$ 148.20
16"	60T	ATB+R	.165"	.118"	1"	15	CR1660	\$ 153.60
16"	80T	ATB+R	.165"	.118"	1"	15	CR1680	\$ 171.40

Popular Tools**General Purpose Saws
Alternate Top**

These saws are designed for general si ing and cutting of natural woods. A higher number of teeth provides a finer edge to the cut, but should be used only on thinner material. The blades designated by the prefix GAL have laser cuts in the body to help reduce noise.

DIAMETER	TEETH	DESIGN	KERF	PLATE	BORE	HOOK	ORDER ID	PRICE
160 mm	48T	ATB	2.2 mm	1.5 mm	20 mm	10	FS16048A	\$ 48.40
7 1/4"	24T	ATB	.110"	.079"	5/8"	20	RS72524	\$ 56.60
7 1/4"	40T	ATB	.110"	.079"	5/8"	10	GA72540	\$ 62.40
7 1/4"	60T	ATB	.110"	.079"	5/8"	10	GA72560	\$ 70.40
8"	40T	ATB	.118"	.079"	5/8"	10	GA840	\$ 62.40
8"	60T	ATB	.118"	.079"	5/8"	10	GA860	\$ 77.00
9"	40T	ATB	.126"	.087"	5/8"	10	GA940	\$ 70.40
9"	60T	ATB	.126"	.087"	5/8"	10	GA960	\$ 77.00
250mm	60T	ATB	3.2mm	2.2mm	30mm, 2/7/42	10	GAM2503060	\$ 58.40
250mm	80T	ATB	3.2mm	2.2mm	30mm, 2/7/42	10	GAM2503080	\$ 71.20
10"	40T	ATB	.126"	.087"	5/8"	10	GA1040	\$ 52.60
10"	40T	ATB	.126"	.087"	1"	10	GA1040R	\$ 52.60
10"	40T	ATB	.126"	.087"	5/8"	10	GAL1040	\$ 63.40
10"	60T	ATB	.126"	.087"	5/8"	10	GA1060	\$ 53.40
10"	60T	ATB	.126"	.087"	1"	10	GA1060R	\$ 53.40
10"	60T	ATB	.126"	.087"	5/8"	10	GAL1060	\$ 65.40
10"	60T	ATB	.126"	.087"	5/8"	10	GAM1060	\$ 65.40
10"	80T	ATB	.126"	.087"	5/8"	10	GA1080	\$ 68.00
10"	80T	ATB	.126"	.087"	1"	10	GA1080R	\$ 68.00
10"	80T	ATB	.126"	.087"	5/8"	10	GAL1080	\$ 77.00
10"	80T	ATB	.126"	.087"	5/8"	10	GAM1080	\$ 77.00
10"	100T	ATB	.126"	.087"	5/8"	10	GA1010	\$ 128.60
300mm	72T	ATB	3.2mm	2.2mm	30mm, 2+2PH	10	GAM3003072	\$ 85.00
300mm	96T	ATB	3.2mm	2.2mm	30mm, 2+2PH	10	GAM3003096	\$ 97.00
12"	36T	ATB	.126"	.087"	1"	20	RS1236	\$ 83.20
12"	48T	ATB	.134"	.094"	1"	10	GA1248	\$ 77.00
12"	60T	ATB	.134"	.094"	1"	10	GA1260	\$ 71.20
12"	80T	ATB	.134"	.094"	5/8"	10	GA1280P	\$ 86.60
12"	80T	ATB	.134"	.094"	1"	10	GA1280	\$ 86.60
12"	80T	ATB	.134"	.094"	1"	10	GAL1280	\$ 90.80
12"	80T	ATB	.165"	.118"	1"	10	GA1280CW	\$ 146.60
12"	100T	ATB	.126"	.087"	1"	10	TS1210	\$ 115.80
350mm	72T	ATB	3.5mm	2.5mm	30mm, 2+2PH	10	GAM3503072	\$ 126.20
350mm	96T	ATB	3.2mm	2.5mm	30mm, 2+2PH	10	GAM3503096	\$ 139.00
14"	40T	ATB	.184"	.134"	1"	0	GA1440	\$ 167.40
14"	60T	ATB	.157"	.118"	1"	10	GA1460	\$ 118.20
14"	60T	ATB	.157"	.118"	1"	10	GAL1460	\$ 122.00
14"	80T	ATB	.157"	.118"	1"	10	GA1480	\$ 136.60
14"	80T	ATB	.157"	.118"	1"	10	GAL1480	\$ 139.00

Notes

These 500mm, 520mm, and 600mm are for the Grecon and Paul optimizing up cut saws.

** This blade is for Triad Open Stringer saw.

Popular Tools

General Purpose Saws Alternate Top

These saws are designed for general si ing and cutting of natural woods. A higher number of teeth provides a finer edge to the cut, but should be used only on thinner material. The blades designated by the prefix GAL have laser cuts in the body to help reduce noise.

DIAMETER	TEETH	DESIGN	KERF	PLATE	BORE	HOOK	ORDER ID	PRICE
14"	100T	ATB	.157"	.118"	1"	10	GA1410	\$ 153.60
14"	120T	ATB	.165"	.118"	1"	10	GA1412	\$ 178.20
400mm	60T	ATB	3.5mm	2.5mm	30mm	15	GA4003060	\$ 122.00
400mm	120T	ATB	4.6mm	3.4mm	30mm	10	GA4003012	\$ 178.20
16"	40T	ATB	.185"	.134"	1"	10	GA1640	\$ 163.60
16"	54T	ATB	.165"	.126"	1"	10	GA1654HD	\$ 153.60
16"	60T	ATB	.165"	.126"	1"	10	GA1660	\$ 156.00
16"	80T	ATB	.165"	.126"	1"	10	GA1680	\$ 163.60
16"	100T	ATB	.165"	.126"	1"	10	GA1610	\$ 183.60
18"	40T	ATB	.180"	.134"	1"	10	GA1840	\$ 178.20
18"	60T	ATB	.180"	.134"	1"	10	GA1860	\$ 197.20
18"	80T	ATB	.180"	.134"	1"	10	GA1880	\$ 216.80
18"	100T	ATB	.180"	.134"	1"	10	GA1810	\$ 245.20
18"	120T	ATB	.180"	.134"	1"	10	GA1812	\$ 275.00
18"	140T	ATB	.180"	.134"	1"	10	GA1814	\$ 315.40
19"	140T	ATB	.180"	.134"	1"	10	GA19140	\$ 394.40
20"	40T	ATB	.194"	.134"	1"	10	GA2040	\$ 223.00
20"	60T	ATB	.180"	.134"	1"	10	GA2060	\$ 244.20
20"	80T	ATB	.180"	.134"	1"	10	GA2080	\$ 269.20
20"	100T	ATB	.180"	.134"	1"	10	GA2010	\$ 286.40
20"	120T	ATB	.180"	.134"	1"	10	GA2012	\$ 309.60
24"	40T	ATB	.245"	.165"	1"	5	GA2440	\$ 357.00
26"	80T	ATB	.245"	.165"	1"	5	GA2680A	\$ 523.40
26"	100T	ATB	.245"	.165"	1"	5	GA2610A	\$ 540.00
26"	120T	ATB	.245"	.165"	1"	5	GA2612	\$ 595.00
28"	80T	ATB	.245"	.165"	1"	5	GA2880	\$ 540.00
30"	80T	ATB	.260"	.200"	1 1/4"	10	TRIAD3080**	\$ 782.20

Notes

*These 500mm, 520mm, and 600mm are for the Grecon and Paul optimizing up cut saws.

** This blade is for Triad Open Stringer saw.

Popular Tools

General Purpose Saws Triple Chip

These saws are designed for high production cutting of natural woods, plywood, chipboard, and MDF. The TCG teeth offer less wear than the ATB with nearly the same quality of cut. The blades designated by the prefix GTL have laser cuts in the body to help reduce noise.

DIAMETER	TEETH	DESIGN	KERF	PLATE	BORE	HOOK	ORDER ID	PRICE
7 1/4"	40T	TCG	.110"	.079"	5/8"	10	GT740	\$ 62.40
7 1/4"	60T	TCG	.110"	.079"	5/8"	10	GT760	\$ 72.80
8"	40T	TCG	.118"	.079"	5/8"	10	GT840	\$ 65.40
8"	60T	TCG	.118"	.079"	5/8"	10	GT860	\$ 81.60
220mm	64T	TCG	3.2mm	2.2mm	30mm, 2/7/42	10	GTM22064	\$ 85.00
250mm	60T	TCG	3.2mm	2.2mm	30mm, 2/7/42	10	GTM2503060	\$ 58.40

DIAMETER	TEETH	DESIGN	KERF	PLATE	BORE	HOOK	ORDER ID	PRICE
250mm	80T	TCG	3.2mm	2.2mm	30mm, 2/7/42	10	GTM2503080	\$ 73.80
10"	40T	TCG	.126"	.087"	5/8"	10	GT1040	\$ 52.60
10"	40T	TCG	.126"	.087"	1"	10	GT1040R	\$ 52.60
10"	40T	TCG	.126"	.087"	5/8"	10	GTM1040	\$ 63.40
10"	60T	TCG	.126"	.087"	5/8"	10	GT1060	\$ 53.40
10"	60T	TCG	.126"	.087"	1"	10	GT1060R	\$ 53.40
10"	60T	TCG	.126"	.087"	5/8"	10	GTL1060	\$ 65.40
10"	60T	TCG	.126"	.087"	5/8"	10	GTM1060	\$ 65.40
10"	80T	TCG	.126"	.087"	5/8"	10	GT1080	\$ 68.00
10"	80T	TCG	.126"	.087"	1"	10	GT1080R	\$ 68.00
10"	80T	TCG	.126"	.087"	5/8"	10	GTL1080	\$ 77.00
10"	80T	TCG	.126"	.087"	5/8"	10	GTM1080	\$ 77.00
10"	80T	TCG	.126"	.087"	5/8"	-5	LM1080TCG	\$ 90.80
10"	100T	TCG	.126"	.087"	5/8"	10	GT1010	\$ 128.60
300mm	72T	TCG	3.2mm	2.2mm	30mm, 2+2 PH	10	GTM3003072	\$ 87.40
300mm	96T	TCG	3.2mm	2.2mm	30mm, 2+2 PH	10	GTM3003096	\$ 97.00
12"	48T	TCG	.134"	.094"	1"	10	GT1248	\$ 79.20
12"	60T	TCG	.134"	.094"	1"	10	GT1260	\$ 61.20
12"	72T	TCG	.134"	.094"	1"	10	GTM1272	\$ 97.00
12"	80T	TCG	.134"	.094"	1"	10	GT1280	\$ 88.20
12"	80T	TCG	.134"	.094"	1"	10	GTM1280	\$ 108.20
12"	96T	TCG	.142"	.102"	1"	10	GTM1296	\$ 126.20
350mm	54T	TCG	3.5mm	2.4mm	30mm	10	GTM3503054	\$ 89.20
350mm	80T	TCG	3.5mm	2.5mm	30mm, 2+2 PH	10	GTM3503080	\$ 126.20
350mm	96T	TCG	3.5mm	2.5mm	30mm, 2+2 PH	10	GTM3503096	\$ 141.60
14"	54T	TCG	.138"	.094"	1"	10	GTM1454	\$ 100.40
14"	60T	TCG	.157"	.118"	1"	10	GT1460	\$ 125.40
14"	80T	TCG	.157"	.118"	1"	10	GT1480	\$ 140.80
14"	100T	TCG	.157"	.118"	1"	10	GT1410	\$ 163.60
16"	60T	TCG	.165"	.126"	1"	10	GT1660	\$ 157.80
16"	80T	TCG	.165"	.126"	1"	10	GT1680	\$ 180.20
16"	100T	TCG	.165"	.126"	1"	10	GT1610	\$ 209.40
16"	100T	TCG	.165"	.126"	1"	-5	GTM1610*	\$ 225.60
16"	120T	TCG	.165"	.126"	1"	10	GT1612	\$ 209.40
16"	120T	TCG	.165"	.126"	1"	-5	GTM1612*	\$ 227.20
18"	40T	TCG	.180"	.134"	1"	10	GT1840	\$ 199.80
18"	60T	TCG	.180"	.134"	1"	10	GT1860	\$ 218.40
18"	80T	TCG	.180"	.134"	1"	10	GT1880	\$ 237.60
18"	100T	TCG	.180"	.134"	1"	10	GT1810	\$ 268.40
18"	100T	TCG	.180"	.134"	1"	-5	GTM1810*	\$ 266.80
18"	120T	TCG	.180"	.134"	1"	10	GT1812	\$ 272.60
18"	120T	TCG	.180"	.134"	1"	-5	GTM1812*	\$ 276.80
20"	60T	TCG	.180"	.134"	1"	10	GT2060	\$ 263.00
20"	80T	TCG	.180"	.134"	1"	10	GT2080	\$ 269.20
20"	100T	TCG	.180"	.134"	1"	10	GT2010	\$ 301.60
20"	120T	TCG	.180"	.134"	1"	10	GT2012	\$ 317.00

Popular Tools
Optimizing Saws
Dimter

The new Popular Tools optimizing saw blades are precision cut, ground, tensioned, and balanced to strict tolerances which are crucial for straight cuts at high RPMs. The saw body has specially formulated epoxy filled expansion slots in the body to eliminate noise and vibration. Due to the strenuous running conditions for optimizing saws, we take special care and maintain extremely tight tolerances in manufacturing these blades to deliver the highest quality into each blade.

DIAMETER	TEETH	DESIGN	KERF	PLATE	BORE	HOOK	WOOD TYPE	ORDER ID	PRICE
400	100	ATB	4.4	3.2	30mm	15	Hard Wood	OPD400100A	\$ 208.00
400	100	HATB	4.4	3.2	30mm	15	Soft Wood	OPD400100H	\$ 216.40
450	138	ATB	4.8	3.5	30mm	15	Hard Wood	OPD450138A	\$ 391.20
450	138	HATB	4.8	3.5	30mm	15	Soft Wood	OPD450138H	\$ 399.40
500	144	ATB	5	3.5	30, 2/15/63	15	Hard Wood	OPD500144A	\$ 471.00
500	144	HATB	5	3.5	30, 2/15/63	15	Soft Wood	OPD500144H	\$ 482.60
520	144	ATB	5	3.5	30, 2/15/63	15	Hard Wood	OPD520144A	\$ 487.60
520	144	HATB	5	3.5	30, 2/15/63	15	Soft Wood	OPD520144H	\$ 499.20
600	144	ATB	5	3.5	30, 2/15/63	10	Soft Wood	OPD60030144	\$ 528.00

Optimizing Saws Paul

DIAMETER	TEETH	DESIGN	KERF	PLATE	BORE	HOOK	WOOD TYPE	ORDER ID	MACHINE	PRICE
500	96	TCG	5	3.5	70mm, 6/8/220	15	Hard Wood	OPP50096T	Paul 11	\$ 499.20
500	120	ATB	5	3.5	70mm, 6/8/220	15	Mid Hard Wood	OPP500120A	Paul 11	\$ 532.60
570	120	ATB	5	3.5	120mm, 6/10.5/240	15	Hard Wood	OPP570120A	Paul 14 (old)	\$ 590.80
570	120	HATB	5	3.5	120mm, 6/10.5/240	15	Soft Wood	OPP570120H	Paul 14 (old)	\$ 607.40
600	144	ATB	5	3.5	120mm, 6/10.5/240	15	Hard Wood	OPP600144A	Paul C14 (new)	\$ 607.40
600	144	HATB	5	3.5	120mm, 6/10.5/240	15	Soft Wood	OPP600144H	Paul C14 (new)	\$ 624.00

Popular Tools
Brush Cutting Saws

DIAMETER	TEETH	DESIGN	KERF	PLATE	BORE & PINS	HOOK	ORDER ID	PRICE
9"	12T	FTG	.142"	.087"	1"	2	BR912	\$ 41.60

This carbide tipped blade is for cutting brush, saplings and thick grasses with gas powered, brush cutter/weed trimmer machines.

Popular Tools
Steel Cutting Saws

These steel cutting saws use micro-grain tips with titanium to provide greater impact strength and durability. They cut through ferrous metal like angle iron, steel pipe, flat bar, and rebar. Please note maximum RPM varies.



ST748K

DIAMETER	TEETH	DESIGN	KERF	PLATE	BORE	HOOK	Max. RPM	ORDER ID	PRICE
7-1/4"	48T	ST	.087"	.071"	5/8"	0/15	3,500	ST748K	\$ 69.60
8"	50T	ST	.087"	.071"	5/8"	0/15	3,000	ST850K	\$ 75.40
9"	50T	ST	.094"	.071"	5/8"	0/15	2,900	ST950	\$ 115.80
10"	50T	ST	.094"	.071"	5/8"	0/15	2,800	ST1050	\$ 115.80
12"	60T	ST	.094"	.079"	1"	0/15	1,800	ST1260K	\$ 135.20
12"	80T	ST	.094"	.079"	1"	0/15	1,800	ST1280K	\$ 155.20
14"	72T	ST	.094"	.079"	1"	0/15	1,700	ST1472K	\$ 155.20
14"	90T	ST	.094"	.079"	1"	0/15	1,700	ST1490K	\$ 174.00

Popular Tools

Trim Saws

The trim saw blades are designed with a higher number of teeth to keep a fine cut on the finish side of your material.

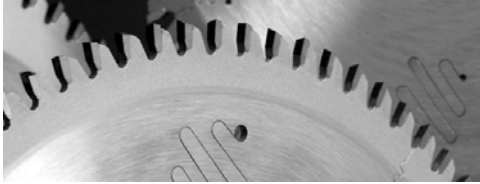

TS1812

DIAMETER	TEETH	DESIGN	KERF	PLATE	BORE	HOOK	ORDER ID	PRICE
9"	72T	ATB	.118"	.079"	5/8"	10	TS972	\$ 80.80
12"	100T	ATB	.126"	.087"	1"	10	TS1210	\$ 115.80
14"	80T	ATB	.126"	.087"	1"	10	TS1480	\$ 125.40
14"	100T	ATB	.126"	.087"	1"	10	TS1410126	\$ 148.20
14"	100T	ATB	.138"	.094"	1"	10	TS1410138	\$ 171.40
14"	120T	ATB	.126"	.087"	1"	10	TS1412	\$ 156.00
15"	100T	ATB	.138"	.094"	1"	10	TS1510	\$ 169.80
16"	80T	ATB	.138"	.094"	1"	10	TS1680	\$ 144.00
16"	100T	ATB	.138"	.094"	1"	10	TS1610	\$ 177.40
16"	120T	ATB	.138"	.094"	1"	10	TS1612	\$ 183.60
18"	80T	ATB	.157"	.118"	1"	10	TS1880	\$ 181.80
18"	100T	ATB	.157"	.118"	1"	10	TS1810	\$ 197.20
18"	120T	ATB	.157"	.118"	1"	10	TS1812	\$ 216.80

Popular Tools

Precision Trim Saws

The Precision Trim saw has teeth which are beveled on the face and top. This improvement on the standard ATB design gives an extra-fine cutting edge. The raker tooth cleans away any stray saw dust so the teeth cut with perfect precision. This is the smoothest cutting blade you will find. Add stabilizers to achieve super-fine cuts.



PT1210

DIAMETER	TEETH	DESIGN	KERF	PLATE	BORE	HOOK	FACE BEVEL	ORDER ID	PRICE
10"	80T	LRLRS	.126"	.087"	5/8"	10	10	PT1080	\$ 104.60
10"	100T	LRLRS	.118"	.087"	5/8"	10	10	PT1010	\$ 133.60
12"	100T	LRLRS	.126"	.087"	1"	10	10	PT1210	\$ 144.00
12"	120T	LRLRS	.118"	.087"	5/8"	10	10	PT1212P	\$ 156.00
12"	120T	LRLRS	.118"	.087"	1"	10	10	PT1212	\$ 156.00
14"	100T	LRLRS	.126"	.095"	1"	10	10	PT1410	\$ 156.00
14"	120T	LRLRS	.126"	.095"	1"	10	10	PT1412	\$ 159.40
16"	120T	LRLRS	.157"	.118"	1"	10	5	PT1612157	\$ 195.60
18"	100T	LRLRS	.157"	.118"	1"	10	5	PT1810	\$ 204.00
18"	120T	LRLRS	.157"	.118"	1"	10	5	PT1812	\$ 225.60

Popular Tools

Professional Series

The professional series blades are designed with contractors in mind. The PR724 & PR740 come with a diamond knockout and anti-kickback design.



PR1060

DIAMETER	TEETH	DESIGN	KERF	PLATE	BORE	ORDER ID	PRICE
6 1/2"	20T	ATB	.079"	.051"	5/8"	PR620	\$ 11.00
7 1/4"	24T	ATB	.087"	.051"	5/8"	PR724	\$ 6.80
7 1/4"	40T	ATB	.087"	.051"	5/8"	PR740	\$ 14.60
8"	40T	ATB	.102"	.063"	5/8"	PR840HD	\$ 40.40
8"	40T	ATB	.122"	.079"	5/8"	PR840LW	\$ 43.80
10"	24T	FTG	.110"	.079"	5/8"	PR1024F	\$ 25.80
10"	36T	ATB	.102"	.067"	5/8"	PR1036	\$ 30.00
10"	50T	ATB+R	.110"	.078"	5/8"	PR1050	\$ 36.20
10"	60T	ATB	.110"	.078"	5/8"	PR1060	\$ 39.60
10"	80T	LRLRS	.098"	.059"	5/8"	PR1080KB	\$ 55.00
12"	40T	ATB	.118"	.079"	1"	PR1240	\$ 55.00
12"	72T	ATB	.110"	.078"	1"	PR1272	\$ 57.60
12"	96T	ATB	.110"	.078"	1"	PR1296	\$ 67.00

Popular Tools Glue Joint RIP Saws

Designed for operations requiring an extra-smooth cut such as solid wood pieces that will be glued together. Use these blades for rip cuts only. Glue Joint Rip Saws can be bored out to fit most gang rip saws. Please call for information and pricing on this service.

DIAMETER	TEETH	DESIGN	KERF	PLATE	BORE	HOOK	ORDER ID	PRICE
10"	30T	TCG	.125"	.087"	5/8"	20	GJ1030125	\$ 72.80
10"	30T	TCG	\$ 0.13	\$ 0.09	70mm, 2 key	20	GJ1030125K	\$ 85.80
10"	30T	TCG	.145"	.102"	5/8"	20	GJ1030	\$ 104.00
10"	40T	ATB	.126"	.087"	5/8"	20	GJ1040	\$ 83.20
300mm	36T	TCG	4.2mm	3.2mm	***80mm, 2 key	20	GJRM30036	\$ 114.00
300mm	48T	TCG	2.8mm	2.0mm	***80mm, 2 key	20	GJRM3004828	\$ 127.00
12"	36T	TCG	.165"	.118"	1"	20	GJ1236	\$ 106.20
12"	36T	TCG	.165"	.118"	70mm, 2 key	20	GJ1236K	\$ 110.68
12"	36T	TCG	.165"	.118"	3 1/8"	20	GJM1236157*	\$ 118.20
12"	48T	ATB	.157"	.118"	1"	20	GJ1248ATB	\$ 142.40
12"	50T	LRLRS	.134"	.094"	1"	20	GJL1250	\$ 140.80
14"	36T	TCG	.177"	.138"	1"	20	GJ1436177	\$ 138.20
14"	36T	ATB	.177"	.138"	2", 2 PH	20	GJ1436DA**	\$ 138.20
14"	36T	TCG	.177"	.138"	2", 2 PH	20	GJ1436DT**	\$ 138.20
14"	36T	TCG	.177"	.138"	3 1/8"	20	GJM1436T	\$ 138.20
16"	36T	TCG	.177"	.138"	2", 2 PH	20	GJ1636**	\$ 152.00
16"	36T	TCG	.177"	.138"	1"	20	GJ1636R	\$ 132.80
16"	50T	TCG	.197"	.138"	1"	20	GJ1650	\$ 200.00
18"	48T	TCG	.180"	.138"	2", 2 PH	20	GJ1848**	\$ 197.20

Notes

* Designed for Mereen-Johnson rip saws with 3 1/8" arbor and with one 1/4" keyway.

** Specially designed for cutting with Diehl saws, (2) 9/16" pin hole at 5" bolt circle.

*** For Raimann Rip Saw with 4 small 7 mm pins & 2 large 14mm pins, plus 2 keyways.

Popular Tools Multi-Score Split Saws



RSMS1040T

These blades are used in Multiscore rip applications, with three mounting holes on each half. 8" x 64T (RSMS500) comes with two outside blades with a groover in between for 1/2" wide groove.

DIAMETER	TEETH	DESIGN	KERF	PLATE	BORE	HOOK	ORDER ID	PRICE
8"	60T	ATB+R	.148"	.087"	4 5/16"	0	RSMS860	\$ 128.60
10"	40T	TCG	.126"	.087"	4 5/16"	5	RSMS1040T	\$ 85.00
10"	60T	TCG	.126"	.087"	4 5/16"	5	RSMS1060T	\$ 87.40
10"	80T	HATB	.126"	.087"	4 5/16"	0	RSMS1080HA	\$ 126.20
12"	60T	TCG	.126"	.087"	4 5/16"	5	RSMS1260T	\$ 104.60
14"	80T	ATB	.150"	.110"	4 5/16"	5	RSMS1480A	\$ 164.80

Popular Tools Rip & Gang Saws - ATB

These saws are designed to rip soft or hard woods where a strong grain pattern can cause the saw to drift and follow the grain. The ATB design helps maintain direction and provide a clean straight cut. These can be bored out to fit most gang rip saws. Please call for more information.

DIAMETER	TEETH	DESIGN	KERF	PLATE	BORE	HOOK	ORDER ID	PRICE
7 1/4"	24T	ATB	.110"	.079"	5/8"	20	RS72524	\$ 56.60
8"	24T	ATB	.118"	.079"	5/8"	20	RS824	\$ 59.20
8 1/2"	24T	ATB	.118"	.087"	5/8"	20	RS85024	\$ 62.40
10"	24T	ATB	.126"	.087"	5/8"	20	RS1024	\$ 58.40
10"	30T	ATB	.134"	.094"	5/8"	20	RS1030	\$ 69.60
12"	24T	ATB	.134"	.094"	1"	20	RS1224	\$ 66.20
12"	24T	ATB	.134"	.094"	70mm, 2 key*	20	RS1224K	\$ 68.00
12"	36T	ATB	.126"	.087"	1"	20	RS1236	\$ 83.20
12"	36T	ATB	.134"	.094"	1"	20	RS1236134	\$ 100.40

Notes

* RS1224K- 70mm bores have two 20mm x 5mm keyways for SCM Rip Saws.

Popular Tools Rip & Gang Saws - FTG/TCG

These saws are designed to rip soft or hard woods where chiseling action of FTG is effective. FTG grind is the fastest, most efficient tooth design for ripping. 20 degree hook angle for all rip saws.



DIAMETER	TEETH	DESIGN	KERF	PLATE	BORE	ORDER ID	PRICE
8"	24T	FTG	.118"	.087"	5/8"	RF824	\$ 54.20
9"	24T	FTG	.126"	.087"	5/8"	RF924	\$ 60.00
10"	10T	FTG	.145"	.102"	5/8"	RF101	\$ 48.00
10"	24T	FTG	.126"	.087"	5/8"	RF1024126	\$ 58.40
10"	24T	FTG	.145"	.102"	5/8"	RF1024145	\$ 63.40
10"	24T	FTG	.126"	.087"	70mm, 2 key*	RF1024K	\$ 63.40
10"	30T	FTG	.160"	.118"	5/8"	RF1030	\$ 85.00
10"	40T	FTG	.126"	.087"	5/8"	RF1040	\$ 71.20
10"	40T	TCG	.126"	.087"	3***	RSLH10403	\$ 77.00
10"	40T	TCG	.126"	.087"	4 3/16***	RSLH10404	\$ 77.00
300mm	28T	FTG	3.4mm	2.4mm	80mm, 2 key****	RFRM30028	\$ 91.60
12"	24T	FTG	.126"	.087"	1"	RF1224126	\$ 68.00
12"	24T	FTG	.134"	.094"	1"	RF1224134	\$ 73.80
12"	24T	FTG	.160"	.110"	1"	RF1224160	\$ 79.20
12"	24T	FTG	.185"	.126"	1"	RF1224185	\$ 81.60
12"	24T	FTG	.126"	.087"	70mm, 2 key*	RF1224K	\$ 68.00
12"	24T	FTG	.160"	.110"	70mm, 2 key*	RF1224K160	\$ 81.60
12"	30T	FTG	.134"	.094"	1"	RF1230	\$ 90.00
12"	30T	FTG	.165"	.118"	1"	RF1230160	\$ 103.60
12"	30T	FTG	.165"	.118"	70mm, 2 key*	RF1230K	\$ 103.60
12"	36T	FTG	.134"	.094"	1"	RF1236134	\$ 97.00
12"	36T	FTG	.165"	.118"	70mm, 2 key*	RF1236K	\$ 106.20
12"	24T	FTG	.126"	.087"	3 1/8", (1)1/4" key	RSM1224126	\$ 70.40
12"	36T	FTG	.126"	.087"	3 1/8", (1)1/4" key	RSM1236F	\$ 85.80
12"	36T	TCG	.126"	.087"	3 1/8", (1)1/4" key	RSM1236TA	\$ 94.60
12"	36T	TCG	.165"	.118"	3 1/8", (1)1/4" key	RSM1236TB	\$ 112.40
350mm	48T	TCG	4.2mm	3.0mm	95mm, 2 key, 8 pins	RF3504895T	\$ 227.20
350mm	48T	TCG	4.2mm	3.0mm	120mm, 2 key	RF35048120T	\$ 227.20
14"	24T	FTG	.142"	.102"	1"	RF1424	\$ 127.20
14"	24T	FTG	.170"	.118"	1"	RF1424170	\$ 136.60
14"	24T	FTG	.194"	.134"	1"	RF1424194	\$ 136.60
14"	24T	FTG	.142"	.102"	70mm, 2 key*	RF1424K	\$ 133.60
14"	24T	FTG	.177"	.134"	3 1/8"	RSM1424T	\$ 137.40
14"	30T	FTG	.165"	.118"	1"	RF1430	\$ 140.80
14"	36T	FTG	.165"	.118"	1"	RF1436	\$ 148.20
14"	36T	FTG	.142"	.102"	70mm, 2 key*	RF1436K	\$ 148.20
14"	40T	FTG	.170"	.118"	1"	RF1440	\$ 159.40
16"	24T	FTG	.173"	.126"	1"	RF1624	\$ 142.40
16"	36T	FTG	.173"	.126"	1"	RF1636	\$ 157.80
18"	40T	FTG	.185"	.134"	1"	RF1840	\$ 181.80
20"	40T	FTG	.185"	.134"	1"	RF2040	\$ 198.20

Notes

*10", 12" & 14" - 70mm bores have two 20mm x 5mm keyways for SCM Rip Saws.

** RSLH comes in 3" or 4 3/16" arbores with 3 pinholes. Fits Lauderdale Hamilton Rip Saw.

*** Multi-Score Rip Saw, Split body, sold as a pair.

**** For Raimann Rip Saw with 4 small 7 mm pins & 2 large 14mm pins, plus 2 keyways.

Popular Tools
Thin Saws

Thin saws keep material waste to a minimum and require less horsepower to cut the material efficiently. Use these in place of standard kerf blades.



DIAMETER	TEETH	DESIGN	KERF	PLATE	BORE	HOOK	ORDER ID	PRICE
8"	60T	TCG	.080"	.055"	5/8"	15	TH860T	\$ 86.40
8 1/4"	24T	ATB	.080"	.055"	5/8"	15	TH82524	\$ 67.20
8 1/4"	40T	ATB	.080"	.055"	5/8"	15	TH82540	\$ 72.00
8 1/4"	60T	ATB	.080"	.055"	5/8"	15	TH82560A	\$ 86.40
8 1/2"	40T	ATB	.080"	.055"	5/8"	15	TH85040	\$ 76.00
8 1/2"	60T	ATB	.080"	.055"	5/8"	15	TH8506080	\$ 91.20
8 1/2"	60T	TCG	.102"	.071"	5/8"	15	TH85060T	\$ 92.80
10"	40T	ATB	.080"	.055"	5/8"	15	TH104080	\$ 76.00
10"	40T	ATB	.095"	.063"	5/8"	15	TH104095	\$ 72.80
10"	60T	ATB	.080"	.060"	5/8"	-2	RATH106080	\$ 86.40
10"	60T	ATB	.080"	.060"	5/8"	15	TH106080	\$ 83.20
10"	60T	ATB	.095"	.063"	5/8"	15	TH106095	\$ 86.40
10"	60T	TCG	.095"	.063"	5/8"	15	TH106095T	\$ 86.40
10"	80T	ATB	.080"	.055"	5/8"	15	TH108080	\$ 103.20
10"	80T	ATB	.095"	.063"	5/8"	15	TH108095A	\$ 106.40
10"	80T	TCG	.095"	.063"	5/8"	15	TH108095T	\$ 106.40
12"	60T	ATB	.110"	.079"	1"	15	TH1260	\$ 111.20
12"	80T	ATB	.110"	.079"	1"	-5	RATH1280A	\$ 88.00
12"	80T	TCG	.110"	.079"	1"	-5	RATH1280T	\$ 88.00
12"	80T	ATB	.110"	.079"	1"	15	TH1280	\$ 116.00
12"	80T	TCG	.110"	.079"	1"	15	TH1280T	\$ 116.00
12"	100T	ATB	.102"	.071"	1"	15	TH1210A	\$ 148.80
12"	100T	TCG	.102"	.071"	1"	15	TH1210T	\$ 153.60

Popular Tools
Ultra Thin Saws

Designed for cutting very soft, thin, expensive material, allowing for very little waste. Not for cutting hardwoods. Please consult us before choosing this saw blade. (Use stabilizer for stability) **Limited Warranty**



DIAMETER	TEETH	DESIGN	KERF	PLATE	BORE	HOOK	ORDER ID	PRICE
7 1/4"	80T	ATB	.055"	.039"	5/8"	15	UT72580	\$ 130.40
8"	80T	ATB	.055"	.039"	5/8"	15	UT880	\$ 132.80
10"	100T	ATB	.071"	.047"	5/8"	15	UT1010	\$ 145.60
12"	100T	ATB	.080"	.055"	1"	15	UT1210	\$ 152.00

Popular Tools
Thin Rim Saws

Designed for cutting fine, fragile and thin-walled material. Thin kerf helps reduce chipping when cutting very thin material. Automatically-braided premium-grade carbide tips increase the life of saw blade.

DIAMETER	TEETH	DESIGN	KERF	PLATE	HUB	BORE	ORDER ID	PRICE
10"	80T	TCG	2.0mm	1.5mm	2.0mm	5/8"	TM1080	\$ 197.60
12"	100T	TCG	2.2mm	1.6mm	2.2mm	1"	TM1210	\$ 227.20

Popular Tools

Mitre & Double Mitre Saws

MS and MD series saws are designed for mitre saw machines to cut molding or picture frame material. Saws with CTC (California Triple Chip) design are made to cut any wood or light metal without changing blades for different materials.



MD1210P

DIAMETER	TEETH	DESIGN	KERF	PLATE	BORE	HOOK	ORDER ID	PRICE
8"	60T	ATB+R	.112"	.079"	5/8"	-2	MD860	\$ 77.00
8 1/2"	40T	ATB+R	.102"	.071"	5/8"	-2	MD85040	\$ 87.40
9"	60T	ATB+R	.112"	.087"	5/8"	0	MD960	\$ 104.60
10"	80T	ATB+R	.118"	.094"	5/8"	-2	MD1080	\$ 118.20
10"	90T	CTC	.126"	.098"	5/8"	-2	MDC1090	\$ 162.00
10"	100T	ATB+R	.118"	.094"	5/8"	-2	MD1010	\$ 129.40
260mm	80T	ATB+ R	2.5mm	1.7mm	30mm	-2	MD26080	\$ 98.20
275mm	80T	ATB	3.2mm	2.4mm	32mm	0	MD27580	\$ 138.20
275mm	100T	ATB+R	3.0mm	2.4mm	32mm	0	MD275100	\$ 153.60
12"	80T	ATB	.126"	.102"	5/8"	-2	MD1280ATB	\$ 144.00
12"	80T	ATB+R	.126"	.102"	5/8"	-2	MD1280P	\$ 144.00
12"	80T	ATB+R	.126"	.102"	1"	-2	MD1280R	\$ 144.00
12"	96T	CTC	.134"	.110"	5/8"	-2	MDC1296	\$ 184.40
12"	100T	ATB+R	.126"	.102"	5/8"	-2	MD1210P	\$ 163.60
12"	100T	ATB+R	.126"	.102"	1"	-2	MD1210R	\$ 163.60
12"	100T	LRLRS	.126"	.094"	1"	0	MS-050	\$ 142.40
13"	90T	ATB+R	.145"	.118"	1"	2	MD1390	\$ 181.80
350mm	100T	TCG	3.5mm	2.8mm	30mm	-2	MD3503010T	\$ 184.40
350mm	100T	ATB+R	4.2mm	2.8mm	30mm	-2	MD3503010G	\$ 184.40
14"	80T	ATB+R	.134"	.110"	5/8"	-2	MD1480P	\$ 174.00
14"	80T	ATB+R	.134"	.110"	1"	-2	MD1480R	\$ 174.00
14"	100T	ATB+R	.134"	.110"	5/8"	-2	MD1410P	\$ 183.60
14"	100T	ATB+R	.134"	.110"	1"	-2	MD1410R	\$ 183.60
15"	100T	ATB+R	.138"	.098"	1"	-2	MS1510	\$ 183.60

Notes

10" and 12" mitre saw blades have 4 laser slits in the plate for vibration and noise control. In addition, the chromed body makes cleaning easy and rust free.

Popular Tools

Door Jamb Saws

This blade is designed for jamb saws to cut door jambs when installing carpet or tile. The blades feature a tapered bore with 2 pinholes.

DIAMETER	TEETH	DESIGN	KERF	PLATE	BORE	ORDER ID	PRICE
6 1/2"	40T	TCG	.118"	.079"	1/2"	PT 65040	\$ 53.40

Popular Tools

Blind Cutting Saws



KC1412

For cutting faux wood window blinds, these saw blades are designed to reduce chipping and to avoid melting on the material. With thinner plate, a sharper tooth angle, and one side clearance ground, this is a completely new tool for window blind fabricators.

DIAMETER	TEETH	DESIGN	KERF	PLATE	BORE	HOOK	FACE BVL	ORDER ID	PRICE
6"	70T	LR	.071"	.043"	5/8"	15	10	LTL670	\$ 115.80
205mm	80T	LRLRS	2.2mm	1.5mm	5/8"	10	15	NM880	\$ 112.40
10"	80T	LRLRS	.098"	.059"	5/8"	10	5	PR1080KB	\$ 55.00
10"	100T	LRLRS	.095"	.063"	5/8"	10	10	KC1010	\$ 144.80
12"	120T	LRLRS	.095"	.063"	1"	10	10	KC1212	\$ 164.80
14"	120T	LRLRS	.126"	.094"	1"	10	10	KC1412	\$ 180.20
14"	140T	LRLRS	.102"	.063"	1"	10	10	KC1414	\$ 183.60

Popular Tools
Chop Saws &
Radial Arm Saws

These saws are designed similar to the General Purpose saw but with a negative hook angle to prevent grabbing. This saw provides excellent crosscuts on all materials.



DIAMETER	TEETH	DESIGN	KERF	PLATE	BORE	HOOK	ORDER ID	PRICE
8 "	60T	ATB	.102"	.071"	5/8"	-5	RA85060	\$ 79.20
10"	40T	ATB	.126"	.087"	5/8"	-5	RA1040A	\$ 63.40
10"	40T	TCG	.126"	.087"	5/8"	-5	RA1040T	\$ 66.20
10"	60T	ATB	.080"	.060"	5/8"	-2	RATH1060800	\$ 85.80
10"	60T	ATB	.126"	.087"	5/8"	-5	RA1060A	\$ 61.60
10"	60T	TCG	.126"	.087"	5/8"	-5	RA1060T	\$ 61.60
12"	40T	ATB	.126"	.087"	1"	-5	RA1240A	\$ 66.20
12"	60T	ATB	.126"	.087"	5/8"	-5	RA1260A58	\$ 77.00
12"	60T	ATB	.126"	.087"	1"	-5	RA1260A	\$ 77.00
12"	60T	TCG	.126"	.087"	1"	-5	RA1260T	\$ 77.00
12"	80T	ATB	.110"	.079"	1"	-5	RATH1280A	\$ 87.40
12"	80T	TCG	.110"	.079"	1"	-5	RATH1280T	\$ 87.40
12"	80T	ATB	.126"	.087"	1"	-5	RA1280A	\$ 104.60
12"	80T	TCG	.126"	.087"	1"	-5	RA1280T	\$ 104.60
14"	40T	ATB	.160"	.120"	1"	0	RA1440	\$ 163.60
14"	40T	ATB	.184"	.134"	1"	0	GA1440	\$ 167.40
14"	60T	ATB	.160"	.118"	1"	0	RA1460A	\$ 132.80
16"	40T	ATB	.165"	.126"	1"	-2	RA1640	\$ 174.00
16"	60T	ATB	.165"	.126"	1"	-2	RA1660	\$ 178.20
450mm	40T	ATB	4.7mm	3.4mm	35mm	15	RA4503540	\$ 203.20
450mm	60T	ATB	4.7mm	3.4mm	35mm	15	RA4503560	\$ 216.80
18"	60T	ATB	.189"	.134"	1"	-5	RA1860	\$ 197.20
18"	80T	ATB	.189"	.134"	1"	-5	RA1880	\$ 220.20

Popular Tools
Thin Saws for Moulding

DIAMETER	TEETH	DESIGN	KERF	PLATE	BORE	HOOK	ORDER ID	PRICE
7"	30T	FTG	.063"	.043"	1 13/16"	20	ML730TR	\$ 75.40
8"	40T	FTG	.063"	.043"	2 13/16"	20	ML840TR	\$ 83.20
8 1/2"	40T	FTG	.063"	.043"	2 13/16"	20	ML85040TR	\$ 95.40
8 1/2"	40T	FTG	.063"	.043"	2 13/16"	20	ML85040TR-T	\$ 95.40
9"	40T	TCG	.063"	.043"	2 13/16"	20	ML940TR	\$ 84.20
10"	36T	TCG	.087"	.059"	2 13/16"	20	ML1036TR	\$ 77.00

These blades have no expansion slots and are designed for tree trimming machines.

Popular Tools
Tree Trimming Saws

DIAMETER	TEETH	DESIGN	KERF	PLATE	BORE	HOOK	ORDER ID	PRICE
20"	60T	ATB	.235"	.150"	1 1/2"	10	JARF2060X	\$ 291.20
24"	60T	ATB	.245"	.165"	1 1/2"	10	TREE2460X	\$ 366.20
24"	72T	ATB	.245"	.165"	1 1/2"	10	*TREE2472X	\$ 372.80
24"	72T	ATB	.260"	.180"	1 1/2"	10	*TREE2472X8	\$ 384.40
24"	72T	ATB	.260"	.180"	1"	10	*TREE2472X840	\$ 384.40
20"	80T	ATB	.209"	.150"	1"	10	KSW2080	\$ 283.00
24"	72T	ATB	.260"	.180"	1 1/2"	10	**KSW2472	\$ 384.40

Popular Tools
Melamine Saws

A higher angle on the top bevel (+30°) gives this saw an extra-sharp shearing action to slice through single or double-sided laminates without chipping. These blades are good for laminates, melamine, coreboard and other composite materials

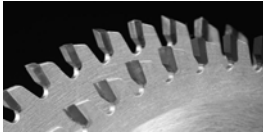

Notes

* For use on Holz-Her or Striebig vertical panel saw.
**Hollow Face Grind

DIAMETER	TEETH	DESIGN	KERF	PLATE	BORE	HOOK	ORDER ID	PRICE
180mm	36T	**HF	2.9mm	2.0mm	30mm	-5	LM18036HF	\$ 97.00
8"	64T	HATB	.118"	.079"	5/8"	-5	LM864	\$ 81.60
220mm	42T	**HF	3.2mm	2.2mm	30mm, 2/7/42	10	LMH22042*	\$ 108.20
220mm	64T	HATB	3.0mm	2.2mm	30mm, 2/7/42	-5	LM22064*	\$ 106.80
250mm	80T	HATB	3.2mm	2.2mm	30mm, 2/7/42	-5	LM2503080*	\$ 83.20
10"	48T	**HF	.126"	.087"	5/8"	10	LM1048HF	\$ 83.20
10"	80T	HATB	.102" (max. cut 1")	.071"	5/8"	0	LM1080X	\$ 90.80
10"	80T	HATB	.126"	.087"	5/8"	-5	LM1080	\$ 81.60
10"	80T	TCG	.126"	.087"	5/8"	-5	LM1080TCG	\$ 90.80
300mm	60T	**HF	3.2mm	2.2mm	30mm, 2 +2 PH	10	LMH30060	\$ 132.80
300mm	80T	HATB	3.2mm	2.2mm	30mm, 2 +2 PH	-5	LM30080*	\$ 128.60
300mm	100T	HATB	3.2mm	2.2mm	30mm, 2 +2 PH	-5	LM30010*	\$ 140.80
12"	80T	HATB	.134"	.094"	1"	-5	LM1280	\$ 127.00
12"	100T	HATB	.134"	.094"	1"	-5	LM1210	\$ 142.40
350mm	96T	HATB	3.6mm	2.8mm	30mm, 2+2 PH	-5	LM3503096	\$ 162.00
14"	100T	HATB	.142"	.110"	1"	-5	LM1410	\$ 165.60
16"	100T	HATB	.158"	.118"	1"	-5	LM1610	\$ 171.60

Popular Tools
Solid Surface Saws

Designed for cutting Corian, Avonite, Fountainhead, Surell, and similar materials. Our special sub-micron carbide will outlast any conventional carbide, delivering a much better cut over a longer life.

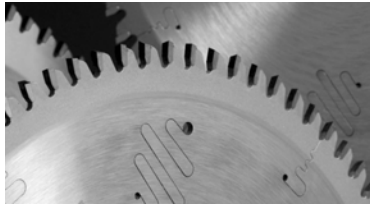

DIAMETER	TEETH	DESIGN	KERF	PLATE	BORE	HOOK	ORDER ID	PRICE
8"	60T	MTCG	.118"	.079"	5/8"	0	SF860	\$ 85.00
220mm	64T	MTCG	3.2mm	2.0mm	30mm, 2/7/42	-2	SF22064	\$ 87.40
250mm	72T	MTCG	3.2mm	2.0mm	30mm, 2/7/42	-2	SF2503072	\$ 90.80
10"	60T	MTCG	.126"	.087"	5/8"	0	SF1060	\$ 77.00
10"	72T	MTCG	.126"	.087"	5/8"	0	SF1072	\$ 92.40
10"	80T	MTCG	.126"	.087"	5/8"	10	SF1080	\$ 100.00
300mm	80T	MTCG	3.4mm	2.4mm	30mm, 2 +2 PH	-2	SF30080	\$ 128.60
12"	80T	MTCG	.135"	.094"	1"	0	SF1280	\$ 126.20
14"	100T	MTCG	.150"	.110"	1"	0	SF1410	\$ 169.80
16"	120T	MTCG	.165"	.118"	1"	0	SF1612	\$ 218.40

Popular Tools
Groovers

Ideal for producing grooves in both hard or softwoods. Bores can be rebored to fit other sizes.



DIAMETER	TEETH	KERF	PLATE	BORE	HOOK	ORDER ID	PRICE
200mm	30T	5.5mm	4.0mm	5/8"	-2	GV20030ABF	\$ 181.80
8"	30T	.260"	.180"	5/8"	-2	GV830ABF	\$ 181.80
8"	30T	.327"	.180"	5/8"	-2	GV830ABF516	\$ 185.20
10"	30T	.260"	.180"	5/8"	-2	GV1030ABF	\$ 203.20
10"	60T	.187"	.126"	5/8"	-5	GV1060HATB	\$ 154.40

Popular Tools
Dado Sets

These sets come with chipper blades for a total of 13/16" width providing super-smooth, splinter-free cuts. Each comes securely packaged in a wooden case and has been tested prior to shipping to ensure a smooth cut.



DIAMETER	TEETH	HOOK	BORE	ORDER ID	PRICE
6"	20T / 4T chipper	20	5/8"	DA620	\$ 194.00
8"	24T / 2T chipper	20	5/8"	DA824	\$ 184.40
8"	40T / 8T chipper	20	5/8"	DA840	\$ 319.60
8"	40T / 8T chipper	-2	5/8"	DA840N	\$ 319.60
8"	40T / 8T chipper	20	1"	DA840G	\$ 319.60
10"	40T / 8T chipper	20	5/8"	DA104058	\$ 385.80
10"	40T / 8T chipper	20	1"	DA1040	\$ 385.80
10"	40T / 8T chipper	-2	1"	DA1040N	\$ 385.80
12"	40T / 8T chipper	20	1"	DA1240	\$ 426.00
12"	40T / 8T chipper	-2	1"	DA1240N	\$ 426.00

Additional Chippers for Dado Sets

DIAMETER	TEETH	PLATE	BORE	ORDER ID	PRICE
8"	8T	1/16"	5/8"	CFP88116	\$ 48.00
8"	8T	3/32"	5/8"	CFP88332	\$ 48.00
8"	8T	1/8"	5/8"	CFP8818	\$ 48.00
10"	8T	1/16"	5/8", 1"	CFP108116	\$ 58.40
10"	8T	3/32"	5/8", 1"	CFP108332	\$ 58.40
10"	8T	1/8"	5/8", 1"	CFP10818	\$ 58.40
12"	8T	1/8"	1"	CFP12818	\$ 58.40
12"	8T	1/16"	1"	CFP128116	\$ 58.40



Popular Tools
Dado Outer Blades

DIAMETER	TEETH	KERF/PLATE	BORE	HOOK	SIDE	ORDER ID	PRICE (L/R)
8"	40T	.126" / .098"	5/8"	-2	LEFT RIGHT	CFP840LHN CFP840RHN	\$ 60.80 \$ 60.80
8"	40T	.126" / .098"	5/8"	20	LEFT RIGHT	CFP840LH CFP840RH	\$ 60.80 \$ 60.80
10"	40T	.126" / .098"	5/8"	20	LEFT RIGHT	CFP104058LH CFP104058RH	\$ 50.80 \$ 50.80
10"	40T	.126" / .098"	1"	-2	LEFT RIGHT	CFP1040LHN CFP1040RHN	\$ 50.80 \$ 45080
10"	40T	.126" / .098"	1"	20	LEFT RIGHT	CFP1040LH CFP1040RH	\$ 50.80 \$ 50.80
12"	40T	.126" / .098"	1"	-2	LEFT RIGHT	CFP1240LHN CFP1240RHN	\$ 62.40 \$ 62.40
12"	40T	.126" / .098"	1"	20	LEFT RIGHT	CFP1240LH CFP1240RH	\$ 62.40 \$ 62.40

Popular Tools
Plastic Cutting Saws

Designed for cutting plastic or vinyl sheets, moldings or extrusions. Maximum cutting thickness of 10 mm (3/8"). Those saws are specially designed to work well on thick sheets of acrylic material. Use stabilizers to get the best result.



PP1010

DIAMETER	TEETH	DESIGN	KERF	PLATE	BORE	HOOK	ORDER ID	PRICE
8"	100T	LR	.087"	.063"	5/8"	10	PP810	\$ 122.00
10"	100T	LR	.087"	.063"	5/8"	10	PP1010	\$ 138.20
12"	100T	LR	.102"	.075"	1"	10	PP1210	\$ 150.20
12"	120T	LR	.102"	.075"	1"	10	PP1212	\$ 179.40
14"	100T	LRLRS	.118"	.087"	1"	20	PP1410	\$ 162.80
14"	120T	LR	.118"	.087"	1"	10	PP1412	\$ 175.60
16"	140T	LR	.126"	.094"	1"	10	PP1614	\$ 195.60
18"	160T	LR	.126"	.094"	1"	10	PP1816	\$ 224.00

Popular Tools
Double Cut Off Saws

Designed for panel si ing double end machines. These are to be used in pairs with one right (3L1R) and one left (3R1L).

DIAMETER	TEETH	DESIGN	KERF	PLATE	BORE	HOOK	ORDER ID	PRICE
12"	80T	3L1R	.165"	.118"	1 1/4"	15	DC1280L	\$ 152.00
12"	80T	3R1L	.165"	.118"	1 1/4"	15	DC1280R	\$ 152.00

Popular Tools
Stablizers

Stablizers keep saw blades staying straight when cutting, increasing cutting accuracy, and extending life of saw blades

DIAMETER	THICKNESS	BORE	ORDER ID	PRICE(PER SET)
4"	.125"	5/8"	STAB4	\$ 16.00
6"	.125"	1"	STAB6	\$ 16.00

Popular Tools
Hardiplank Polycrystalline Diamond Series

Designed to cut faster, cleaner, and will last 150 times longer in cutting cement board like Hardiplank. PCD blades are not intended to cut trough nail or staples. 10" and 12" PCD blades with higher number of teeth are introduced for cutting composite materials, such as phonic with aluminum oxide coating, fiberglass panels, and flooring material coated with aluminum oxide.



PRD106

DIAMETER	TEETH	KERF	PLATE	BORE	ORDER ID	PRICE
7 1/4"	4T	.087"	.063"	5/8"	PRD74	\$ 62.40
8"	6T	.087"	.063"	5/8"	PRD86	\$ 89.20
10"	6T	.094"	.071"	5/8"	PRD106	\$ 91.60
10"	6T	.094"	.071"	30mm	PRD10630	\$ 91.60
10"	18T	.110"	.079"	5/8"	PRD1018*	\$ 266.80
10"	30T	.110"	.087"	5/8"	PRD103032*	\$ 523.80
12"	8T	.087"	.063"	1"	PRD128	\$ 118.20
12"	12T	.087"	.063"	1"	PRD1212	\$ 178.20
12"	48T	.126"	.094"	1"	PCD124832*	\$ 774.60
14"	12T	.150"	.125"	1 1/8"	PRD1412	\$ 195.60

*These Blades Are Good for Cutting Fiberglass Materials

Popular Tools
Truss & Component Saws

Manufactured with a thicker plate for smoother and straighter cuts every time. These blades come with standard tapered mounting holes to fit 5/16" bolt with 82 degree tapering, except TRDS1640 which fits a 1/4" bolt. Size of mounting holes may vary on the open side due to the thickness of saw plates.

*****All truss blades have 10 degree hook angle.*****

DIAMETER	TEETH	TIP	KERF	PLATE	BORE	MTG HOLES	BOLT CIRCLE	MACHINE USED ON	ORDER ID	PRICE
12"	40T	ATB	.142"	.091"	7/8"	3R,3L	2 1/4"	Auto-Omni	TRK1240A	\$ 122.00
14"	40T	ATB	.184"	.134"	1"	3R,3L	3 1/8"	Clary	TR1440A	\$ 159.40
14"	40T	TCG	.185"	.134"	1"	3R,3L	6"	Idaco	TRID1440T	\$ 167.40
14"	40T	TCG	.185"	.134"	1"	3R,3L	3 1/2"	Timber Mill	TRTM1440T	\$ 159.40
14"	60T	TCG	.184"	.134"	1"	3R,3L	3 1/8"	Clary	TR1460T	\$ 201.40
16"	40T	TCG	.184"	.134"	1"	3R,3L	3 1/8"	Clary	TR1640T	\$ 195.60
16"	40T	TCG	.202"	.134"	1"	4R,4L	4"	Monet	TRDS1640	\$ 231.40
16"	40T	ATB	.190"	.148"	7/8"	3R, 3L	2.25", 2.265"	Koskovich	TRK1640K19	\$ 256.40
16"	40T	TCG	.190"	.150"	1.26"	3R, 3L	2.25", 2.265"	Koskovich	TRK1640T25	\$ 256.40
16"	40T	ATB	.190"	.150"	1.26"	3R, 3L	2.25", 2.265"	Koskovich	TRK1640T25A	\$ 256.40
16"	40T	ATB	.185"	.134"	2 1/2"	4/.400"	6"	XL-Saw	TRTCT1640A	\$ 222.20
16"	48T	TCG	.185"	.134"	1"	3R,3L	6"	Idaco	TRID1648T	\$ 225.60

Popular Tools
Truss & Component Saws

Manufactured with a thicker plate for smoother and straighter cuts every time. These blades come with standard tapered mounting holes to fit 5/16" bolt with 82 degree tapering, except TRDS1640 which fits a 1/4" bolt. Size of mounting holes may vary on the open side due to the thickness of saw plates.

*****All truss blades have 10 degree hook angle.*****

DIAMETER	TEETH	TIP	KERF	PLATE	BORE	MTG HOLES	BOLT CIRCLE	MACHINE USED ON	ORDER ID	PRICE
16"	50T	TCG	.202"	.150"	1 1/8"	3R,3L	6"	Mitek	TRMK1650	260.60
16"	60T	TCG	.184"	.134"	1"	3R,3L	3 1/8"	Clary	TR1660T	231.40
16"	60T	TCG	.185"	.134"	1"	3R,3L	3 1/2"	Timber Mill	TRTM1660T	229.80
17"	40T	ATB	.189"	.150"	50mm	6 all Right	64mm	Mitek	TRK1740	271.00
18"	60T	ATB	.209"	.150"	1"	3R,3L	3 1/8"	Clary	TR1860A	292.20
18"	60T	TCG	.209"	.150"	1"	3R,3L	3 1/8"	Clary	TR1860T	292.20
20"	40T	TCG	.205"	.150"	1 1/2"	4R, 4L	3 1/2"	Auto-Omni	TRK2040T	300.60
20"	100T	ATB	.225"	.160"	1 1/2"			Alpine Linear	TR2010	452.80
20"	40T	ATB	.205"	.154"	1 1/2"	4R,4L	3 1/2"	Auto-Omni	TRK2040A	283.80
20"	60T	TCG	.209"	.150"	1"	3R,3L	3 1/8"	Clary	TR2060T	343.20
20"	60T	TCG	.209"	.150"	1"	3R,3L	6"	Idaco	TRID2060T	363.20
20"	60T	TCG	.202"	.150"	1 1/8"	3R,3L	6"	Mitek	TRMK2060	364.60
20"	80T	ATB	.209"	.150"	1"	3R,3L	3 1/8"	Clary	TR2080A	414.80
20"	80T	TCG	.209"	.150"	1"	6 all Right	5"	Timber Mill	TRTM2080TRS	348.80
20.5"	100T	ATB	.225"	.160"	1 1/2"	8 All Right	5 1/4"	Alpine Linear	TR205100	452.80
22"	120T	ATB	.209"	.150"	1"	6 all Right	5"	Clary	TR2212A	433.60
22"	80T	TCG	.209"	.150"	1"	6 all Right	5"	Clary	TR2280T	417.00
22"	80T	TCG	.209"	.150"	1"	6 all Right	4 3/4"	Timber Mill	TRTM2280R	394.40
22"	80T	TCG	.209"	.150"	1"	6 all Left	4 3/4"	Timber Mill	TRTM2280T*	394.40
30"	80T	TCG	.260"	.200"	1-1/2"	(2) 5/8"	3"	Triad	TRIAD3080T	782.20
30"	80T	TCG	.260"	.200"	1 5/8"	6R,6L	6"	Monet	TRDS3080	805.40
30"	80T	ATB	.260"	.200"	1 1/4"	(2) 5/8"	3"	Triad	TRIAD3080A	782.20
30"	80T	TCG	.260"	.200"	1"	3R,3L	6"	Idaco	TRID3080T	782.20
30"	80T	TCG	.260"	.200"	1 1/2"	6R,6L	6"	Auto-Omni	TRK3080	782.20
30"	80T	TCG	.260"	.200"	1 1/8"	6 all Right	6"	Timber Mill	TRTM3080T*	805.40
32"	80T	TCG	.260"	.200"	2"	6 all Left	7"	Clary	TR3280T	832.00
32"	80T	TCG	.260"	.200"	1 3/8"	6 all Left	6"	Mitek	TRMK3280	857.00
32"	80T	TCG	.260"	.200"	1 3/8"	6 all Right	6"	Mitek	TRMK3280R6	857.00
350mm	54T	ATB	3.6mm	2.5mm	50mm	6 (6.5mm)	64mm	Ra er	TRA 35054	148.20
350mm	54T	ATB	4.0mm	2.8mm	50mm	6 (6.5mm)	64mm	Ra er	TRA 35054A4	153.60
350mm	54T	TCG	4.0mm	2.8mm	50mm	6 (6.5mm)	64mm	Ra er	TRA 35054T	153.60
450mm	40T	ATB	4.7mm	3.4mm	35mm			Mangotech	RA4503540	203.20
450mm	60T	ATB	4.7mm	3.4mm	35mm			Mangotech	RA4503560	216.80
650mm	96T	ATB	5.6mm	3.8mm	30mm	2/15, 4/8. 3	100mm, 90mm	Hundegger	TRHN65096	624.00
700mm	84T	ATB	6.2mm	4.2mm	30mm	2/14, 4/8. 5	400mm, 90mm	Hundeggar	TRHN70048	565.80

Notes

* Also available with pinholes mounting All Right. Please specify when ordering. Part# TRTM2280R or TRTM3080R



Popular Tools
Finger Joint
Cutters & Blades

Made with precision CNC machines. They stay sharp and stay longer on the machines. Tight tolerance makes the finger joints stay tight.

DIAMETER	TEETH	PLATE	BORE	ORDER ID	PRICE
160mm	2T	4.0 mm	50mm	FJ1605040	\$ 25.00
160mm	2T	10.0 mm	50mm	FJ1605010	\$ 50.00
160mm	3T	4.0 mm	50mm	FJ16050403T	\$ 37.60
160mm	3T	10.0 mm	50mm	FJ16050103T	\$ 75.00
160mm	2T	4.0 mm	70mm	FJ1607040	\$ 25.00
160mm	2T	10.0 mm	70mm	FJ1607010	\$ 50.00
160mm	3T	4.0 mm	70mm	FJ16070403T	\$ 37.60
160mm	3T	10.0 mm	70mm	FJ16070103T	\$ 75.00
210mm	4T	4.0 mm	70mm	FJ2107040	\$ 66.60
210mm	4T	10.0 mm	70mm	FJ2107010	\$ 133.20
*250mm	6T	3.8 mm	70mm	FJ2507038	\$ 100.00
*250mm	6T	11.4 mm	70mm	FJ2507011	\$ 199.80

DIAMETER	TEETH	BORE	COUNTERSUNK	KERF	DESIGN	ORDER ID	PRICE
*250mm	80T	75mm	6L/95mm/M6	6.0 mm	all LHTB	FJS25075806L	\$ 191.40
*250mm	80T	75mm	6R/95mm/M6	6.0 mm	all RHTB	FJS25075806R	\$ 191.40
*200mm	48T	75mm	6L,6R/95mm/M6	7.0 mm	ATB	FJS20075487	\$ 124.80
255mm	80T	50mm	6L/150mm/M6	4.0 mm	all LHTB	FJS25550804L	\$ 166.40
255mm	80T	50mm	6R/150mm/M6	4.0 mm	all RHTB	FJS25550804R	\$ 166.40
355mm	120T	25.4mm		3.4 mm	LRLRS	FJS355254120	\$ 199.80
*450mm	108T	30mm		4.8 mm	HATB	OPD450108H	\$ 341.20

***For Weing Group (Grecon, Dimter Machines)

all LHTB = all left hand top bevel

all RHTB = all right hand top bevel

Popular Tools
Non-Ferrous Cutting Saws

A specially formulated carbide makes cutting all kinds of non-ferrous metal simple and easy. Cut sheets, extrusions, or light solids of aluminum, copper, and brass. Clamp material firmly and lubricate blade with cutting fluid. **DO NOT USE ON STEEL OR OTHER FERROUS METALS.**

DIAMETER	TEETH	DESIGN	KERF	PLATE	BORE & PINS	HOOK	ORDER ID	PRICE
3 7/8"	20T	TCG	.134"	.110"	3/8"	5	NF3782038	\$ 47.20
4"	20T	TCG	.095"	.062"	3/4"	0	NF420Q	\$ 47.20
4 1/2"	20T	TCG	.095"	.062"	3/4"	0	NF45020Q	\$ 47.20
7 1/4"	40T	TCG	.118"	.087"	5/8"	-5	NF72540	\$ 58.40
7 1/4"	60T	TCG	.087"	.058"	5/8"	0	NF760	\$ 58.40
8"	48T	TCG	.126"	.094"	5/8"	-5	NF848	\$ 76.20
8"	60T	TCG	.118"	.094"	5/8"	-5	NF860	\$ 87.40
8"	80T	TCG	.130"	.083"	5/8"	5	NF880	\$ 100.40
8 1/2"	60T	TCG	.102"	.071"	5/8"	-5	NF85060	\$ 90.80
9"	60T	TCG	.134"	.102"	5/8"	-5	NF960	\$ 102.80
10"	60T	TCG	.118"	.087"	5/8"	-5	NF1060EX	\$ 79.20
10"	60T	TCG	.134"	.102"	5/8"	-5	NF1060	\$ 98.60
10"	80T	TCG	.118"	.087"	5/8"	-5	NF1080EX	\$ 89.20
10"	80T	TCG	.134"	.110"	5/8"	-5	NF1080	\$ 120.00
10"	100T	TCG	.118"	.094"	5/8"	-5	NF1010118	\$ 112.40
10"	100T	TCG	.134"	.110"	5/8"	-5	NF1010	\$ 131.20
10"	120T	FTG	.079"	.055"	5/8"	10	NF1012	\$ 135.20

Popular Tools

Non-Ferrous Cutting Saws

A specially formulated carbide makes cutting all kinds of non-ferrous metal simple and easy. Cut sheets, extrusions, or light solids of aluminum, copper, and brass. Clamp material firmly and lubricate blade with cutting fluid. **DO NOT USE ON STEEL OR OTHER FERROUS METALS.**

DIAMETER	TEETH	DESIGN	KERF	PLATE	BORE & PINS	HOOK	ORDER ID	PRICE
12"	80T	TCG	.126"	.102"	5/8"	-5	NF1280P	\$ 143.20
12"	80T	TCG	.142"	.118"	1"	-5	NF1280	\$ 143.20
12"	100T	TCG	.126"	.102"	5/8"	-5	NF1210P	\$ 151.20
12"	100T	TCG	.134"	.095"	1"	0	NF1210EX	\$ 129.40
12"	100T	TCG	.142"	.118"	1"	-5	NF1210	\$ 151.20
12"	120T	TCG	.126"	.095"	5/8"	-5	NF1212P	\$ 174.00
12"	120T	TCG	.126"	.095"	1"	-5	NF1212	\$ 174.00
13"	120T	TCG	.134"	.110"	1"	-5	NF1312	\$ 214.40
14"	40T	TCG	.150"	.126"	1"	-5	NF1440	\$ 144.00
14"	48T	TCG	.150"	.126"	32mm	-5	NF1448	\$ 152.00
14"	80T	TCG	.150"	.126"	1"	-5	NF1480	\$ 178.20
14"	100T	TCG	.150"	.126"	5/8"	-5	NF1410P	\$ 184.40
14"	100T	TCG	.157"	.130"	1"	-5	NF1410	\$ 184.40
14"	120T	TCG	.146"	.118"	5/8"	-5	NF1412P	\$ 216.80
14"	120T	TCG	.157"	.130"	1"	-5	NF1412	\$ 216.80
15"	80T	TCG	.126"	.102"	1"	-5	NF1580	\$ 153.60
15"	100T	TCG	.126"	.102"	5/8"	-5	NF1510P	\$ 167.40
15"	100T	TCG	.126"	.102"	1"	-5	NF1510	\$ 167.40
16"	60T	TCG	.165"	.134"	1"	-5	NF1660	\$ 189.40
16"	80T	TCG	.165"	.142"	1"	-5	NF1680	\$ 207.60
16"	100T	TCG	.165"	.134"	1"	-5	NF1610	\$ 220.20
16"	120T	CTC	.157"	.130"	1"	-5	NF1612	\$ 284.40
18"	60T	TCG	.230"	.150"	1"	-5	NF1860	\$ 248.40
18"	72T	TCG	.176"	.142"	1 1/2"	0	NF1872MS*	\$ 258.80
18"	80T	TCG	.176"	.138"	1"	-5	NF1880	\$ 267.60
18"	100T	TCG	.176"	.138"	1"	-5	NF1810	\$ 275.00
18"	120T	CTC	.165"	.138"	1"	-5	NF1812	\$ 317.00
20"	40T	TCG	.180"	.150"	1"	0	NF2040	\$ 233.00
20"	60T	TCG	.180"	.150"	1"	0	NF2060	\$ 249.20
20"	60T	TCG	.180"	.150"	1 1/2", 1/(9/16")/3"	0	NF2060MS*	\$ 253.80
20"	72T	TCG	.180"	.150"	1"	0	NF2072	\$ 253.80
20"	72T	TCG	.180"	.150"	1 1/2", 1/(9/16")/3"	0	NF2072MS*	\$ 258.80
20"	80T	TCG	.180"	.150"	1"	-5	NF2080	\$ 257.20
20"	100T	TCG	.180"	.150"	1"	-5	NF2010	\$ 284.60
20"	120T	TCG	.180"	.150"	1"	-5	NF2012	\$ 323.40
20"	160T	TCG	.180"	.150"	1"	-5	NF2016	\$ 372.80
22"	60T	TCG	.180"	.150"	1 1/2", 1/(9/16")/3"	-5	NF2260MS*	\$ 397.00
22"	96T	TCG	.190"	.155"	40mm, 4/12/64	-5	NF2296ES	\$ 465.20
22"	100T	TCG	.180"	.150"	1"	-5	NF2210	\$ 442.80
22"	120T	TCG	.180"	.150"	1"	-5	NF2212	\$ 479.40
22"	150T	TCG	.180"	.150"	1"	0	NF2215	\$ 494.40
22"	60T	CTC	.220"	.160"	1"	5	NF2260CTC	\$ 382.80
22"	72T	TCG	.180"	.150"	1 1/2", 1/(9/16")/6"	0	NF2272MS	\$ 432.80

Popular Tools

Non-Ferrous Cutting Saws

A specially formulated carbide makes cutting all kinds of non-ferrous metal simple and easy. Cut sheets, extrusions, or light solids of aluminum, copper, and brass. Clamp material firmly and lubricate blade with cutting fluid. **DO NOT USE ON STEEL OR OTHER FERROUS METALS.**

DIAMETER	TEETH	DESIGN	KERF	PLATE	BORE & PINS	HOOK	ORDER ID	PRICE
24"	48T	CTC	.235"	.165"	1"	0	NF2448	\$ 407.80
24"	60T	TCG	.205"	.165"	1"	5	NF2460	\$ 421.00
24"	60T	TCG	.205"	.165"	1 1/2", 2/(9/16")/4 3/4"	5	NF2460MS*	\$ 422.80
24"	72T	TCG	.205"	.165"	1"	5	NF2472	\$ 430.20
24"	72T	TCG	.205"	.165"	1 1/2", 2/(9/16")/4 3/4"	5	NF2472MS*	\$ 433.60
24"	80T	TCG	.205"	.165"	1"	-5	NF2480	\$ 441.00
24"	100T	TCG	.205"	.165"	1"	0	NF2410	\$ 461.00
24"	120T	TCG	.157"	.134"	1"	5	NF2412157	\$ 507.60
24"	120T	TCG	.205"	.165"	1"	-5	NF2412	\$ 483.40
24"	160T	TCG	.205"	.165"	1"	-5	NF2416	\$ 534.20
24"	160T	TCG	.205"	.165"	30mm	-5	NF243016	\$ 540.00
26"	48T	CTC	.235"	.165"	1"	0	NF2648	\$ 500.20
26"	72T	TCG	.230"	.181"	1"	2	NF2672	\$ 540.00
26"	80T	TCG	.235"	.165"	1"	0	NF2680	\$ 567.60
26"	120T	TCG	.235"	.165"	1"	0	NF2612	\$ 679.00
28"	72T	CTC	.230"	.180"	1 1/2", 1/(7/16")/5 3/8" + 1/(5/8)/9 1/2"	2	NF2872MS*	\$ 704.80
28"	80T	TCG	.240"	.181"	1 1/2", 1/(7/16")/5 5/16" + 1 (11/16")/ 9 1/2"	0	NF2880MS*	\$ 721.40
28"	150T	TCG	.235"	.165"	1"	0	NF2815	\$ 798.80
30"	80T	TCG	.260"	.200"	1 1/4"	0	NF3080	\$ 782.20
30"	80T	TCG	.261"	.201"	1"	0	NF30801	\$ 782.20
30"	120T	TCG	.248"	.200"	1"	2	NF3012	\$ 831.20
180mm	36T	TCG	3.5mm	2.2mm	20mm	0	NFEL1802036	\$ 156.60
250mm	80T	TCG	3.0mm	2.2mm	30mm, 2/7/42	0	NF2503080	\$ 120.00
275mm	80T	TCG	3.2mm	2.4mm	32mm	0	NF2753280	\$ 128.60
300mm	90T	TCG	3.2mm	2.4mm	32mm	-5	NF30090	\$ 136.60
300mm	100T	TCG	3.4mm	2.6mm	30mm, 2+2 PH	-5	NF3003010	\$ 142.40
330mm	90T	TCG	3.4mm	2.8mm	32mm	-5	NF3303290	\$ 174.00
350mm	60T	TCG	3.2mm	2.5mm	30mm	-5	NF3503060	\$ 157.80
350mm	72T	TCG	3.2mm	2.5mm	30mm	-5	NF3503072	\$ 159.40
350mm	84T	TCG	3.2mm	2.5mm	30mm	-5	NF3503084	\$ 161.00
350mm	84T	TCG	3.2mm	2.5mm	32mm, 4/12/64	-5	NF3503284	\$ 161.00
350mm	84T	TCG	3.6mm	3.0mm	40mm, 2/9/55 + 4/12/64	-5	NF3504084	\$ 167.40
350mm	108T	TCG	3.2mm	2.5mm	32mm, 4/12/64	-5	NF35032108	\$ 178.20
350mm	120T	TCG	3.2mm	2.5mm	1"	-5	NF350120	\$ 194.00
380mm	100T	TCG	3.8mm	3.2mm	32mm	0	NF38032100	\$ 169.80
400mm	72T	TCG	4.2mm	3.4mm	30mm	0	NF4003072	\$ 215.20
400mm	96T	TCG	3.8mm	2.8mm	50mm, 4/15/80	0	NF4005096	\$ 228.00
400mm	100T	TCG	4.2mm	3.4mm	30mm	-5	NF4003010	\$ 241.00
420mm	96T	TCG	4.2mm	3.4mm	30mm	0	NF4203096	\$ 242.60
420mm	120T	CTC	4.2mm	3.4mm	30mm	0	NF4203012CTC	\$ 308.80
420mm	96T	TCG	4.2mm	3.4mm	50mm, 4/15/80	0	NF4205096	\$ 270.00
450mm	96T	TCG	4.2mm	3.4mm	30mm	0	NF4503096	\$ 286.40

Popular Tools
Non-Ferrous Cutting Saws

A specially formulated carbide makes cutting all kinds of non-ferrous metal simple and easy. Cut sheets, extrusions, or light solids of aluminum, copper, and brass. Clamp material firmly and lubricate blade with cutting fluid. **DO NOT USE ON STEEL OR OTHER FERROUS METALS.**

DIAMETER	TEETH	DESIGN	KERF	PLATE	BORE & PINS	HOOK	ORDER ID	PRICE
500mm	100T	TCG	4.6mm	3.8mm	30mm, 4/12/64	0	NF5003010	\$ 283.00
500mm	100T	TCG	4.0mm	3.2mm	30mm, 4/12/64	5	NF5003010F	\$ 292.20
500mm	100T	TCG	3.0mm	2.5mm	40mm, 2/12/64	0	NF5004012L	\$ 399.40
500mm	120T	TCG	4.6mm	3.8mm	30mm, 4/12/64	0	NF5003012	\$ 322.40
500mm	120T	TCG	4.0mm	3.2mm	30mm, 4/12/64	5	NF5003012F	\$ 339.60
500mm	120T	TCG	4.6mm	3.8mm	32mm, 4/12/64	0	NF5003212	\$ 325.80
500mm	80T	TCG	4.0mm	3.2mm	32, 6 All Right + 2/6/75	5	NF5003280ELU	\$ 324.60
500mm	120T	TCG	4.0mm	3.2mm	32, 6 All Right + 2/6/75	5	NF5003212ELU	\$ 352.80
500mm	160T	TCG	4.0mm	3.2mm	30mm	5	NF5003016F	\$ 367.80
500mm	160T	TCG	4.0mm	3.2mm	30mm	5	NF5003016FL	\$ 367.80
550mm	80T	TCG	4.6mm	3.8mm	30mm	0	NF5503080	\$ 461.80
550mm	100T	TCG	4.6mm	3.8mm	30mm	0	NF5503010	\$ 470.20
550mm	120T	TCG	4.6mm	3.8mm	30mm	0	NF5503012	\$ 503.40
550mm	120T	TCG	4.2mm	3.4mm	32mm	5	NF5503012L	\$ 482.60
600mm	108T	FTG	4.0mm	3.4mm	40mm	0	NF60040108	\$ 482.60

Popular Tools
22" -- 30" Saws

Please specify bore size when ordering. Order ID above only shows 1" bore size.
Standard sizes are 1", 1-1/8", 1-1/4", & 1-3/8". No re-bore charge for standard size.

DIAMETER	TEETH	DESIGN	KERF	PLATE	BORE	HOOK	ORDER ID	PRICE
22"	60T	ATB	.220"	.150"	See note below 1", 1 1/8", 1 1/4", & 1 3/8"	5	GA2210060F	\$ 293.00
						-5	GA2210060N	
22"	80T	ATB	.220"	.150"	See note below 1", 1 1/8", 1 1/4", & 1 3/8"	5	GA2210080F	\$ 320.40
						-5	GA2210080N	
22"	100T	ATB	.220"	.150"	See note below 1", 1 1/8", 1 1/4", & 1 3/8"	5	GA22100100F	\$ 347.80
						-5	GA22100100N	
22"	120T	ATB	.220"	.150"	See note below 1", 1 1/8", 1 1/4", & 1 3/8"	5	GA22100120F	\$ 366.20
						-5	GA22100120N	
24"	40T	ATB	.245"	.165"	See note below 1", 1 1/8", 1 1/4", & 1 3/8"	5	GA2440	\$ 357.00
24"	60T	ATB	.245"	.165"	See note below 1", 1 1/8", 1 1/4", & 1 3/8"	5	GA2410060F	\$ 360.40
						-5	GA2410060N	
24"	60T	ATB	.245"	.165"	1 1/2"	10	TREE2460X*	\$ 366.20
24"	72T	ATB	.245"	.165"	1 1/2"	10	TREE2472X*	\$ 372.80
24"	72T	ATB	.260"	.180"	1 1/2"	10	TREE2472X8*	\$ 384.40
24"	80T	ATB	.245"	.165"	See note below 1", 1 1/8", 1 1/4", & 1 3/8"	5	GA2410080F	\$ 380.40
						-5	GA2410080N	
24"	100T	ATB	.245"	.165"	See note below 1", 1 1/8", 1 1/4", & 1 3/8"	5	GA24100100F	\$ 397.00
						-5	GA24100100N	
24"	120T	ATB	.245"	.165"	See note below 1", 1 1/8", 1 1/4", & 1 3/8"	5	GA24100120F	\$ 415.20
						-5	GA24100120N	
26"	80T	ATB	.245"	.165"	See note below 1", 1 1/8", 1 1/4", & 1 3/8"	5	GA2680A	\$ 523.40
26"	100T	ATB	.245"	.165"	See note below 1", 1 1/8", 1 1/4", & 1 3/8"	5	GA2610A	\$ 540.00
26"	120T	ATB	.245"	.165"	See note below 1", 1 1/8", 1 1/4", & 1 3/8"	5	GA2612	\$ 595.00
28"	80T	ATB	.245"	.165"	See note below 1", 1 1/8", 1 1/4", & 1 3/8"	5	GA2880	\$ 540.00
30"	80T	ATB	.260"	.200"	1 1/4", 2 / 5/8" / 3"	10	TRIAD3080**	\$ 782.20

*These blades have no expansion slots and are designed specially for tree trimming machines

**This blade is for Triad Open Stringer Saw

Popular Tools

Lucas Saws



This is a newly introduced five toothed thin kerf blade for the Lucas portable Mill. The blade can mill the face of a board one direction and trim the edge on the return trip all in one pass.

DIAMETER	TEETH	DESIGN	KERF	PLATE	BORE	ORDER ID	PRICE
424mm	5T	FTG	5.0mm	2.8mm	20mm, 4+5 pins	LUCAS424	\$ 179.40
546mm	5T	FTG	5.7mm	3.2mm	30mm, 5+5 pins	LUCAS546	\$ 183.20

Popular Tools

Strob Saws - FTG

Made for durability and are great for cutting wet lumber. Also, these strob blades work great for pallet building applications.

DIAMETER	TEETH	KERF	PLATE	BORE	MACHINE	ORDER ID	PRICE
8"	9T	.157"	.096"	2-3/8", 3/8" key	Pendu	U896PNT2	41.20
10"	10T	.143"	.083"	2-15/16", 3 keys	Brewer	U1083BR	45.40
10"	10T	.143"	.083"	2-3/8", 3/8" key	Pendu	U1083PNT2	45.40
10"	10T	.157"	.096"	2-3/8", 3/8" key	Pendu	U1096PN	49.60
10"	10T	.170"	.110"	1"	Various	U10110T2	51.60
10"	10T	.170"	.110"	2-3/8", 3/8" key	Pendu	U10110PNT2	51.60
12"	12T	.157"	.096"	1"	Various	U1296	51.60
12"	12T	.157"	.096"	2", 1/4" key	Ha elthorn	U1296HRT2	51.60
12"	12T	.143"	.083"	2-3/8", 3/8" key	Pendu	U1283PNT2	49.60
12"	12T	.157"	.096"	2-3/8", 3/8" key	Pendu	U1296PNT2	51.60
12"	12T	.170"	.110"	1"	Various	U12110	60.00
12"	12T	.170"	.110"	2-3/8", 3/8" key	Pendu	U12110PNT2	60.00
12"	12T	.170"	.110"	2-15/16", 3 keys	Brewer	U12110BRT2	60.00
12"	12T	.143"	.083"	2-15/16", 3 keys	Brewer	U121283BR	49.60
12"	12T	.157"	.096"	2-15/16", 3 keys	Brewer	U121296BRT2	51.60
13"	14T	.157"	.096"	1"	Various	U131496T2	65.40
13"	14T	.157"	.096"	2-15/16", 3 keys	Brewer	U131496BRT2	65.40
14"	14T	.170"	.110"	2-1/2", 3 keys	Brewer	U1414110BRHFT2	73.80
14"	14T	.170"	.110"	2-15/16", 3 keys	Brewer	U1414110BR15T2	73.80
14"	14T	.189"	.120"	1"	Various	U14120T2	79.20
14"	14T	.189"	.120"	2-3/8", 3/8" key	Pendu	U14120PNT2	79.20
14"	14T	.189"	.120"	2-3/8", no key	Various	U14120PNNK	79.20
14"	16T	.143"	.083"	4", 1/2" pinhole	Cornell	U141683CN	65.40
14"	16T	.170"	.110"	4", 1/2" pinhole	Cornell	U1416110CN	75.40
16"	16T	.204"	.134"	1"	Various	U1616134T2	85.80
16"	16T	.204"	.134"	2-1/2", 3 keys	Brewer	U1616134BR T2	85.80
22"	22T	.235"	.165"	1"	Various	U22165C2*	266.40

* U22165 has 6 stobs; 2 from the gullet and 4 in the body

Porter-Cable



Router Collets

Part #	Description	Price
42950	1/2" Router Collet	\$ 17.84
42975	3/8" Router Collet	\$ 20.12
42999	1/4" Router Collet	\$ 16.66



Template Guide

Part #	Description	Price
42000	9-piece Router Template Guide Set	\$ 56.26
42021	1-1/4" Router Template Guide	\$ 17.36
42024	3/4" Router Template Guide	\$ 9.46
42027	7/16" Router Template Guide	\$ 9.46
42030	1" Router Template Guide	\$ 22.38
42033	1/2" Router Template Guide	\$ 9.46
42036	3/8" Router Template Guide	\$ 9.46
42037	3/8" Router Template Guide	\$ 9.46
42039	59/64" Router Template Guide	\$ 17.54
42040	3/4" Router Template Guide	\$ 9.46
42042	51/64" Router Template Guide	\$ 9.46
42045	5/8" Router Template Guide	\$ 9.46
42046	5/8" Template Guide	\$ 9.46
42048	1-35/64" Router Template Guide	\$ 19.06
42050	30 mm Router Template Guide	



Pads

Part #	Description	Price
13592	4-1/2" X 4-1/4" 8 Holes	\$ 10.06
13597	4-1/2" X 4-1/8"	\$ 13.62
13900	5"	\$ 27.10
13901	5" - 5 Holes	\$ 27.10
13904	5" - 5 Holes	\$ 27.10
13905	5" - 5 Holes	\$ 26.60



Porter-Cable

PIN100 1/2-Inch to 1-Inch 23-Gauge Pin Nailer

\$192.66

Uses 23 ga. micro pin nails from 1/2-inch to 1-inch long similar to Senco models
 Tool automatically adjusts for different fastener lengths for easier loading
 Convenient bottom-load magazine holds 170 micro pin nails
 Dual trigger feature
 Low nail reload indicator; Rubber comfort grip on tool handle



Porter-Cable

PIN138 23-Gauge 1-3/8-Inch Pin Nailer

\$228.24

Uses 23-gauge headless and slight head pin nails from 5/8-Inch to 1-3/8-Inch length
 Long life maintenance free motor to keep from staining the work surface
 Includes: nailer, 2000 pin nails of 3/4-Inch, 1/4-Inch plug with cap, wrench, and carrying case
 Consistent power and penetration to sink 1-3/8-Inch nail sub-flush into oak
 Tool automatically adjusts for different fastener lengths for easier loading



Porter-Cable

690LR 11-Amp Fixed-Base Router

\$298.96

11-amp motor producing 1-3/4 peak horsepower
 27,500 revolutions-per-minute single-speed motor
 Precision machined aluminum motor housing and base
 Cam-lock lever enables simple coarse height adjustments and motor release
 11-amp motor producing 1-3/4 peak horsepower
 27,500 revolutions-per-minute single-speed motor
 Precision machined aluminum motor housing and base



Porter-Cable

US58 1/4-Inch to 5/8-Inch 22-Gauge C-Crown Upholstery Stapler

\$226.24

Uses standard Senco Type, 22 ga. 3/8-inch crown staples from 1/4-inch to 5/8-inch long
 Small and lightweight for ease of operation
 1-inch nose extension for limited clearance fastening
 Steel top cap for durability
 Rear exhaust port channels air and tool oil/condensation away from user; Driver guide moves back with magazine, allowing jams to be easily cleared when magazine is open

RELIABLE CUTTING TOOLS

The CopeCrafter

Models CC10-1, CC10-2, and CC16-1.

The Original CopeCrafter was designed by Reliable to complement the Panelcrafter for any shop that desires higher production. The CopeCrafter comes equipped with two clamping cylinders for superior holding.

TWO methods of guiding the Copecrafter in a longitudinal plane across the shaper table:

#1 A straight, Plexiglas template to guide on the vertical wood shaper fence or rub collar.

#2 A 3/4" wide steel bar that attaches to the base of the Copecrafter with two allen cap screws to guide in the miter slot on the shaper table top.

Nine placements for adjusting distance of cutter to spindle. The miter bar has 9 placement settings.

Safety: The material is clamped to the CopeCrafter by two powerful air cylinders. With all "Crafter" family units, the operator's hands are away from the cutting tools.

Ease of Operation: The air flotation on the bottom of the CopeCrafter makes the unit very easy to guide across the shaper table top. Converts an ordinary shaper into a sliding table shaper, with the addition of the CopeCrafter. Use to cut rails for rapid production.

CC-10-1 Specifications:

- Max. Width material clamping: 11-1/2"
- Max. Height material clamping: 2"
- Free Air Required: 1.0 CFM
- 1" Base to match PanelCrafter
- 90-110 PSI

CC-10-1 \$850.00

- 2 Clamping Cylinders
- Air Flotation
- Weight: 31 lbs.
- 1" base



CC-10-2 Specifications:

- Max. Width material clamping: 11-1/2"
- Max. Height material clamping: 2"
- Free Air Required: 1.0 CFM
- 2 Clamping Cylinders
- Use with larger cutters and Insert tooling

CC-10-2 \$1,050.00

- 1-1/2" Base
- Air Flotation
- Approximate Weight: 35lbs.
- 90-100 PSI

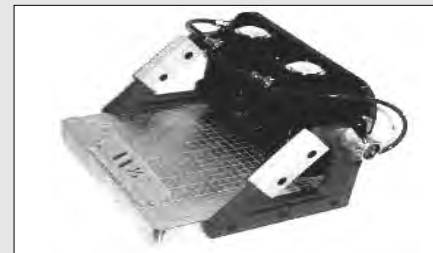

CC-16-1 Specifications:

- Used for Wider Materials
- Max. Width clamping: 16"
- Use as Railcrafter for 16" material
- Cut Rails up to 16" quickly and safely
- 90-110 PSI
- 1.0 CFM

CC-16-1 \$1,050.00

- 1" Base
- Air Flotation
- 2 Clamping Cylinder
- Weight: 40 lbs.

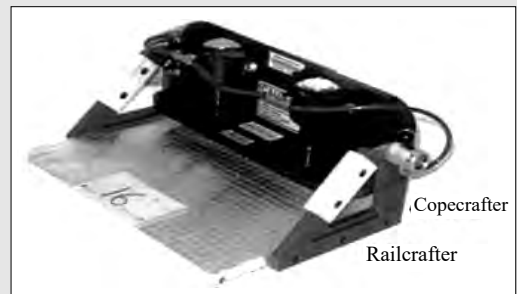

RELIABLE CUTTING TOOLS Panelcrafter

Specifications for Model 406 :	
<ul style="list-style-type: none"> • Max. Width material clamping: 16" • Max. Height material clamping: 1-5/16" • Air Flotation • Weight: 45 lbs. • Includes one set of Independence Design Templates (shown below) • 2 Clamping Cylinders • Thumb Control On-Off Valve • Free Air Required: 1.0 CFM • Panel Width Minimum: 3-1/2" • Panel Width Maximum: 16" 	
PC-406	\$1,250.00 w/o Templates \$1,300.00 with Templates

Specifications for Model 609 :	
<ul style="list-style-type: none"> • Max. Width material clamping: 24" • Max. Height material clamping: 1-7/8" • Air Flotation • Weight: 95 lbs. • Includes one set of Independence Design Templates (shown below) • 2 Clamping Cylinders • Thumb Control On-Off Valve • Free Air Required: 1.5 CFM • Panel Width Minimum: 4" • Panel Width Maximum: 24" 	
PC-609	\$1,500.00 w/o Templates \$1,600.00 with Templates



*EASY OPERATION:
GLIDES ON A CUSHION OF AIR (.002/.003")
*SAFETY: KEEP HANDS AWAY FROM CUTTERS

Specifications for Model PC-762 :	
<ul style="list-style-type: none"> • Max. Width material clamping: 30" • Max. Height material clamping: 1-5/16" • Free Air Required: 1.5 CFM • Weight: 75 lbs. • Starter set templates: 3M/3F 3" Individual Arch 	
PC-762	\$2,150.00

*TIME SAVING: ELIMINATE PRE-BANDSAWING
*CONSTRUCTION: FINEST AIRCRAFT ALUMINUM

ARCHED RAISED PANELS & CROWNS

Shown above is the PANELCRAFTER 609 method of shaping arched raised panels & crowns. For clarity, guards are not shown, but are recommended for safety when operating machinery. With sufficient power & the proper cutters, pre-bandsawing is eliminated.

The X & Y movement is made easy by means of a reverse air flow system. With the control valve, on the left, you control the amount of air cushion from .001 to .003, thru a series of air jets on the bottom of the unit, eliminating friction. Glides over miter bar slot; no need to fill.

The material is centered with a rack & pinion connected directly to the pinion gear with a knob, for easy, maintenance free operation. For safety, hands are kept away from the cutters.

COPE CUTS

Coping is fast, easy & safe with the PC609 PANELCRAFTER. The cope bar is attached to the base with two knob screws. Use a blowout or backer board with the cope bar to eliminate blowout.

RAIL CUTS

Rail cutting is safe & easy using the PC609. Using a straight template, or use straight edge of the #2 female template, on a fence or ball bearing rub collar; adjust cutters to proper depth, then clamp the material securely with the pneumatic clamping cylinders.

WE REALIZE THE QUALITY OF YOUR PRODUCT IS ALL-IMPORTANT. WE HAVE BUILT THE FINEST FIXTURE AVAILABLE FOR RAPID PRODUCTION MANUFACTURING OF COMPLETE RAISED PANEL CABINET DOORS. A COMPLETE DOOR CAN BE MADE IN MINUTES.

RELIABLE CUTTING TOOLS

The DoorCrafter ENTR WA DOOR S STEM

Starter Set Templates 3M/3F 4" Industrial Arch

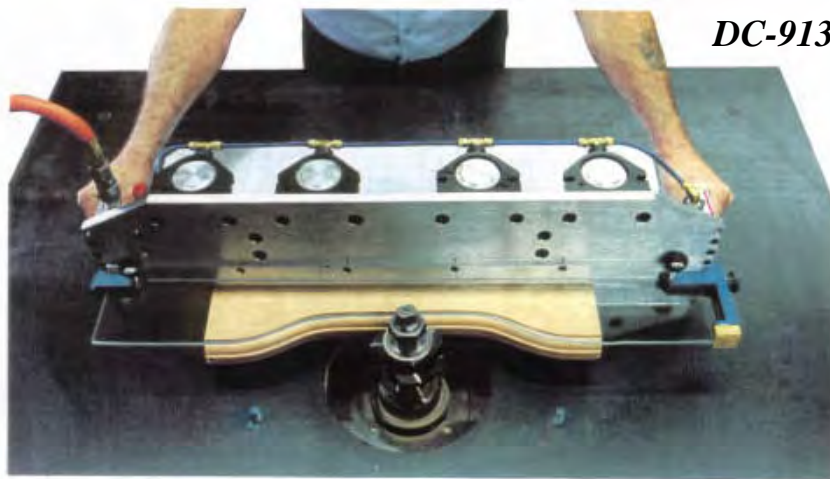

DOORCRAFTER 913

for materials up to 4-7/8" thick by 36" wide
Four pneumatic clamping cylinders. Made in USA of aircraft aluminum. Thumb control on/off valve

- *Four clamping cylinders
 - *Units glide on a cushion of air
 - *Keep hands away from cutters
- These systems are ideal for passageway doors

Features:

- Aircraft Aluminum
- Full Guarantee
- Made in the USA
- Pneumatic Clamping
- Fast and Safe
- 85 lbs.
- 2.0 CFM

Material Clamping

Model	Max Width	Price w/o Template	Price w/ Template
DoorCrafter 913	36"	\$3,000.00	\$3,150.00

Panels from **25"** to **36"** wide. Top Rail to **4-1/4"**. For use on any Heavy Duty Spindle Shaper for arched top rail and arched panels. Has 4 Heavy Duty Pneumatic Clamping Cylinders with air flotation and thumb control with On/Off valve. Applications do **NOT** include kitchen cabinets

- **1-15/16"** Tenon Thickness with Standard Handles
- **3-1/2"** Tenon Thickness 2 Handles - **\$400.00**
- **4-5/8"** Tenon Thickness with 3 Handles - **\$550.00**

SERIOUS TOOLWORKS

Wood Lathe Machine SL2542

Specifications

Swing	Distance Between Centers	Height	Length	Width	Spindle Height	Spindle Taper	Spinder Thread	Spindle Bore	Tailstock Taper	Tailstock Bore	Tailstock Quill Travel	Motor
25"	42"	47"	70"	29"	42"	#3MT	1-1/2" X 8"	5/8"	#3MT	5/8"	6"	3 HP 3 Phase
Weight	Inverter	Spindle Speed 1:1	Spindle Speed 4:1	Spindle Handwheel	Tailstock Handwheel	Motor Sheave	Spindle Sheave	Drive Belt	Banjo Cavity	Faceplate	Tool Rests	
1580 lbs	220 volt 1 Phase 20 amp	100 - 3,600 rpm	25 - 900 rpm	10" Chrome	8" Chrome	8" & 2"	8"	10J Poly V	1-1/4"	4" Steel	16"	



The 1580 pound cast iron frame with a glass smooth metallic charcoal finish, our Poly-V drive train with 4:1 speed reduction, fast rack and pinion tail stock, 3 hp premium efficiency motor, and magnetic remote emergency stop button are just part of what sets us apart from other lathes in the world market.

The Precision Spindle Cartridge weighs 70 pounds and utilizes 4 heavy bearings; but now 48 position indexing, a power lock out safety switch, and outboard 1 1/2" x 8 spindle threads have been added.

Wood turning lathe controlsThe new headstock design incorporates spindle speed digital read out, index position digital read out, variable speed control, forward and reverse switch, and emergency stop button.

Spindle RPM digital display, and indexing digital display

SL2542 is built with a very different design and it is a 100% cast iron machine, which carries a higher material cost than other full size lathes. The 1-3/4" thick bed ways gain the woodturner incomparable rigidity Serious Wood Lathe Feetand the tremendous bottom mass of the SL2542 produces unmatched stability.

Gray cast iron remains as one of the most effective vibration dampening materials used in the construction of precision machinery. Workpiece vibration from unbalanced or wet wood does not reach the bed ways and the tool rest of the SL2542, it simply dissipates into the floor, so the SL2542 operates quieter, smoother, and with less energy than much lighter fabricated steel wood lathes.

Eventually woodturners cut into imbedded bolts, nails, insulators, and rocks. These events produce a lot of trauma for the woodturner and the lathe! Welded lathe beds can and occasionally do break apart with traumatic catches. The SL2542 has a frame constructed with four pieces of seamless cast iron bolted together, so the shock waves can not stress welds or bonds and again dissolve into the ground. Gray cast iron also delivers lower residual stress levels than fabricated steel.

The 3 HP TEFC premium motor in the SL2542 sits on a hinged platform 6" above the floor. We recognize that some woodturners prefer to face the workpiece from the outboard side of the lathe, and for this reason we offer a heavy duty outboard turning kit. This will expand the swing of the lathe to 44 inches.



SOUTHEAST TOOL

CarBiDE-TippED METriC BOring BiT

Dowell Drills - Brad Point -57MM

RH PART #	LH PART #	PRICE	DIA. BRAD POINT 57 OAL
SE5704RH	SE5704LH	\$8.95	4mm
SE57045RH	SE57045LH	\$9.63	4.5mm
SE57187RH	SE57187LH	\$9.63	4.76 mm
SE5705RH	SE5705LH	\$8.20	5mm
SE57051RH	SE57051LH	\$9.75	5.1mm
SE57055RH	SE57055LH	\$9.75	5.5mm
SE5706RH	SE5706LH	\$8.88	6mm
SE57250RH	SE57250LH	\$9.75	6.35mm
SE57065RH	SE57065LH	\$11.81	6.5mm
SE57067RH	SE57067LH	\$11.35	6.7mm
SE5707RH	SE5707LH	\$10.94	7mm
SE57075RH	SE57075LH	\$14.27	7.5mm
SE5708RH	SE5708LH	\$9.95	8mm
SE57082RH	SE57082LH	\$11.86	8.2mm
SE57085RH	SE57085LH	\$14.00	8.5mm
SE5709RH	SE5709LH	\$12.83	9mm
SE57375RH	SE57375LH	\$13.98	9.52mm
SE5710RH	SE5710LH	\$12.57	10mm
SE5711RH	SE5711LH	\$17.54	11mm
SE57438RH	SE57438LH	\$16.17	11.1mm
SE5712RH	SE5712LH	\$14.77	12mm
SE57500RH	SE57500LH	\$22.79	12.7mm
SE5713RH	SE5713LH	\$21.38	13mm
SE5714RH	SE5714LH	\$24.14	14mm
SE5715RH	SE5715LH	\$25.96	15mm
SE57625RH	SE57625LH	\$28.05	15.9mm
SE5716RH	SE5716LH	\$28.05	16mm
SE5717RH	SE5717LH	\$33.32	17mm
SE5718RH	SE5718LH	\$33.32	18mm
SE5719RH	SE5719LH	\$40.03	19mm
SE5720RH	SE5720LH	\$40.03	20mm

NOTE: All Dowell Drills listed above have 57MM Overall Length and 10 MM Shank.

Brad Point - 77MM OAL

LH PART #	RH PART #	PRICE	DIA. BRAD POINT 77 OAL
SE7704RH	SE7704LH	\$10.84	4mm
SE7705RH	SE7705LH	\$10.49	5mm
SE7706RH	SE7706LH	\$11.03	6mm
SE7707RH	SE7707LH	\$13.08	7mm
SE7708RH	SE7708LH	\$12.30	8mm
SE77010RH	SE77010LH	\$14.72	10mm
SE77012RH	SE77012LH	\$16.91	12mm

NOTE: All Dowell Drills listed above have 77MM Overall Length and 10 MM Shank.

Brad Point - 63.5MM - 1/4" Shank

LH PART #	RH PART #	PRICE	DIA. BRAD POINT 63.5 OAL
SE63505RH	SE63505LH	\$13.90	5mm
SE635250RH	SE635250LH	\$14.77	6.35mm

Dowell Drills -Brad Point - 70MM

RH PART #	LH PART #	PRICE	DIA. BRAD POINT 70 OAL
SE7004RH	SE7004LH	\$9.80	4mm
SE70045RH	SE70045LH	\$10.48	4.5mm
SE70187RH	SE70187LH	\$10.48	4.76 mm
SE7005RH	SE7005LH	\$9.00	5mm
SE70051RH	SE70051LH	\$10.58	5.1mm
SE70055RH	SE70055LH	\$10.58	5.5mm
SE7006RH	SE7006LH	\$9.71	6mm
SE70250RH	SE70250LH	\$10.58	6.35mm
SE70065RH	SE70065LH	\$12.64	6.5mm
SE70067RH	SE70067LH	\$12.28	6.7mm
SE7007RH	SE7007LH	\$11.79	7mm
SE70071RH	SE70071LH	\$13.44	7.1mm
SE70075RH	SE70075LH	\$15.11	7.5mm
SE7008RH	SE7008LH	\$10.79	8mm
SE70082RH	SE70082LH	\$12.69	8.2mm
SE70085RH	SE70085LH	\$14.85	8.5mm
SE7009RH	SE7009LH	\$13.66	9mm
SE70375RH	SE70375LH	\$14.81	9.52mm
SE7010RH	SE7010LH	\$13.40	10mm
SE70104RH	SE70104LH	\$19.97	10.4mm
SE7011RH	SE7011LH	\$18.37	11mm
SE70438RH	SE70438LH	\$19.97	11.1mm
SE7012RH	SE7012LH	\$15.60	12mm
SE70500RH	SE70500LH	\$23.63	12.7mm
SE7013RH	SE7013LH	\$22.22	13mm
SE7014RH	SE7014LH	\$24.97	14mm
SE70562RH	SE70562LH	\$22.19	14.29mm
SE7015RH	SE7015LH	\$26.81	15mm
SE70625RH	SE70625LH	\$28.90	15.9mm
SE7016RH	SE7016LH	\$28.90	16mm
SE7017RH	SE7017LH	\$34.16	17mm
SE7018RH	SE7018LH	\$34.16	18mm
SE7019RH	SE7019LH	\$40.86	19mm
SE7020RH	SE7020LH	\$40.86	20mm
SE7025RH	SE7025LH	\$57.58	25mm

NOTE: All Dowell Drills listed above have 70MM Overall Length and 10 MM Shank.

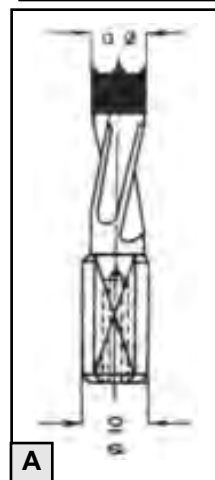

A	57 Series Drills are 57mm
B	70 Series Drills are 70mm
C	77 Series Drills are 77mm
D	63.5 Series Drills are 63.5mm

SOUTHEAST TOOL

CArBiDE-TippED METriC BOrIng BiTs (continued)

V Point - 70MM OAL

LH PART #	RH PART #	PRICE	DIA. V POINT 70 OAL
SEV7004RH	SEV7004LH	\$15.29	4mm
SEV70187RH	SEV70187LH	\$15.38	4.76mm
SEV7005RH	SEV7005LH	\$12.83	5mm
SEV70055RH	SEV70055LH	\$16.14	5.5mm
SEV7006RH	SEV7006LH	\$14.78	6mm
SEV70250RH	SEV70250LH	\$16.14	6.35mm
SEV70065RH	SEV70065LH	\$17.64	6.5mm
SEV7007RH	SEV7007LH	\$15.87	7mm
SEV7008RH	SEV7008LH	\$17.25	8mm
SEV70082RH	SEV70082LH	\$18.95	8.2mm
SEV7009RH	SEV7009LH	\$21.67	9mm
SEV70375RH	SEV70375LH	\$25.22	9.52mm
SEV7010RH	SEV7010LH	\$23.13	10mm
SEV70102RH	SEV70102LH	\$26.48	10.2mm
SEV70104RH	SEV70104LH	\$25.10	10.4mm
SEV7011RH	SEV7011LH	\$28.27	11mm
SEV70111RH	SEV70111LH	\$28.27	11.1mm
SEV7012RH	SEV7012LH	\$27.32	12mm
SEV70500RH	SEV70500LH	\$33.47	12.7mm
SEV7013RH	SEV7013LH	\$33.47	13mm
SEV7014RH	SEV7014LH	\$34.41	14mm
SEV70142RH	SEV70142LH	\$32.97	14.2mm
SEV7015RH	SEV7015LH	\$39.26	15mm
SEV7016RH	SEV7016LH	\$41.93	16mm
SEV7018RH	SEV7018LH	\$54.96	18mm
SEV7019RH	SEV7019LH	\$60.20	19mm

NOTE: All V Point Boring Bits listed above have 70MM Overall Length and 10 MM Shank.

Hinge Bits - 57MM OAL

LH PART #	RH PART #	PRICE	DIA. BRAD POINT 57 OAL
SEHB5715RH	SEHB5715LH	\$15.07	15mm
SEHB5716RH	SEHB5716LH	\$15.07	16mm
SEHB5717RH	SEHB5717LH	\$15.60	17mm
SEHB5718RH	SEHB5718LH	\$16.52	18mm
SEHB5719RH	SEHB5719LH	\$17.44	19mm
SEHB5720RH	SEHB5720LH	\$17.72	20mm
SEHB5722RH	SEHB5722LH	\$17.83	22mm
SEHB5724RH	SEHB5724LH	\$19.00	24mm
SEHB5725RH	SEHB5725LH	\$19.68	25mm
SEHB5726RH	SEHB5726LH	\$20.18	26mm
SEHB5728RH	SEHB5728LH	\$20.70	28mm
SEHB5730RH	SEHB5730LH	\$20.70	30mm
SEHB5732RH	SEHB5732LH	\$21.91	32mm
SEHB5734RH	SEHB5734LH	\$22.43	34mm
SEHB5735RH	SEHB5735LH	\$21.52	35mm
SEHB5736RH	SEHB5736LH	\$23.61	36mm
SEHB5738RH	SEHB5738LH	\$23.61	38mm
SEHB5740RH	SEHB5740LH	\$24.94	40mm

NOTE: All Hinge Bits have 57MM Overall Length and 10 MM Shank.

V Point - 58MM OAL

LH PART #	RH PART #	PRICE	DIA. V POINT 58 OAL
SEV5804RH	SEV5804LH	\$14.45	4mm
SEV58187RH	SEV58187LH	\$14.61	4.76mm
SEV5805RH	SEV5805LH	\$12.01	5mm
SEV58055RH	SEV58055LH	\$15.31	5.5mm
SEV5806RH	SEV5806LH	\$13.95	6mm
SEV58250RH	SEV58250LH	\$15.31	6.35mm
SEV58065RH	SEV58065LH	\$16.81	6.5mm
SEV5807RH	SEV5807LH	\$15.02	7mm
SEV58079RH	SEV58079LH	\$15.11	7.9mm
SEV5808RH	SEV5808LH	\$16.42	8mm
SEV5809RH	SEV5809LH	\$20.84	9mm
SEV58375RH	SEV58375LH	\$24.39	9.52mm
SEV5810RH	SEV5810LH	\$22.30	10mm
SEV5811RH	SEV5811LH	\$27.44	11mm
SEV58111RH	SEV58111LH	\$27.44	11.1mm
SEV5812RH	SEV5812LH	\$26.48	12mm
SEV58500RH	SEV58500LH	\$32.64	12.7mm
SEV5813RH	SEV5813LH	\$32.64	13mm
SEV5814RH	SEV5814LH	\$33.58	14mm
SEV5815RH	SEV5815LH	\$38.42	15mm
SEV5816RH	SEV5816LH	\$41.09	16mm
SEV5818RH	SEV5818LH	\$42.65	18mm

NOTE: All V Point Boring Bits listed above have 58MM Overall Length and 10 MM Shank.

V Point - 77MM OAL

LH PART #	RH PART #	PRICE	DIA. BRAD POINT 77 OAL
SEV7704RH	SEV7704LH	\$16.61	4mm
SEV7705RH	SEV7705LH	\$14.39	5mm
SEV7706RH	SEV7706LH	\$16.10	6mm
SEV7707RH	SEV7707LH	\$17.16	7mm
SEV7708RH	SEV7708LH	\$18.56	8mm
SEV7710RH	SEV7710LH	\$24.44	10mm
SEV7712RH	SEV7712LH	\$28.63	12mm

NOTE: All Long Dowell Drills have 77MM Overall Length and 10 MM Shank.

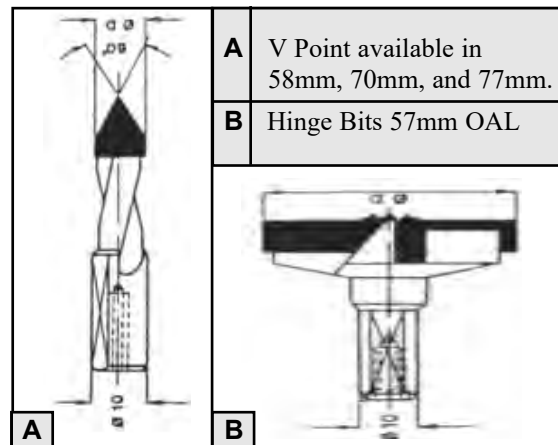

A V Point available in 58mm, 70mm, and 77mm.

B Hinge Bits 57mm OAL

SOUTHEAST TOOL

CARBiDE-TippED METriC BOring BiTs

HINGE BITS 70MM OAL

LH PART #	RH PART #	PRICE	DIA. HINGE BITS 70 OAL
SEHB7015RH	SEHB7015LH	\$16.13	15mm
SEHB7016RH	SEHB7016LH	\$16.13	16mm
SEHB70165RH	SEHB70165LH	\$17.64	16.5mm
SEHB7017RH	SEHB7017LH	\$16.65	17mm
SEHB7018RH	SEHB7018LH	\$17.57	18mm
SEHB7019RH	SEHB7019LH	\$18.47	19mm
SEHB7020RH	SEHB7020LH	\$18.51	20mm
SEHB7022RH	SEHB7022LH	\$17.83	22mm
SEHB7024RH	SEHB7024LH	\$19.01	24mm
SEHB7025RH	SEHB7025LH	\$19.68	25mm
SEHB7026RH	SEHB7026LH	\$20.18	26mm
SEHB7028RH	SEHB7028LH	\$20.70	28mm
SEHB7030RH	SEHB7030LH	\$20.70	30mm
SEHB7032RH	SEHB7032LH	\$22.95	32mm
SEHB7034RH	SEHB7034LH	\$23.48	34mm
SEHB7035RH	SEHB7035LH	\$22.55	35mm
SEHB7036RH	SEHB7036LH	\$24.65	36mm
SEHB7038RH	SEHB7038LH	\$24.65	38mm
SEHB7040RH	SEHB7040LH	\$26.00	40mm

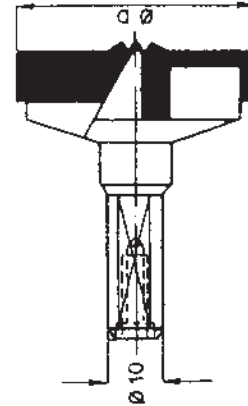

NOTE: All Brad Point Boring Bits listed above have 70MM Overall Length and 10 MM Shank.

SOLiD CARBiDE BOring BiTs WITH sTEEL sHANK

Brad Point

LH PART #	RH PART #	PRICE	OAL	TWIST LENGTH	DIAMETER
SCBP5703RH	SCBP5703LH	\$15.56	57mm	18mm	3mm
SCBP5704RH	SCBP5704LH	\$18.23	57mm	20mm	4mm
SCBP5705RH	SCBP5705LH	\$20.11	57mm	20mm	5mm
SCBP5706RH	SCBP5706LH	\$20.92	57mm	20mm	6mm
SCBP5708RH	SCBP5708LH	\$26.51	57mm	20mm	8mm
SCBP7003RH	SCBP7003LH	\$16.76	70mm	28mm	3mm
SCBP7004RH	SCBP7004LH	\$19.45	70mm	30mm	4mm
SCBP7005RH	SCBP7005LH	\$21.04	70mm	30mm	5mm
SCBP7006RH	SCBP7006LH	\$22.13	70mm	30mm	6mm
SCBP7008RH	SCBP7008LH	\$29.24	70mm	30mm	8mm

V Point

SCVP5805RH	SCVP5805LH	\$22.79	58mm	20mm	5mm
SCVP5808RH	SCVP5808LH	\$26.15	58mm	20mm	8mm
SCVP7005RH	SCVP7005LH	\$23.74	70mm	20mm	5mm
SCVP7008RH	SCVP7008LH	\$31.92	70mm	20mm	8mm

NOTE: All V Point Boring Bits listed above have 70MM Overall Length and 10 MM Shank.



SOUTHEAST TOOL

Drills

SeLF CenTeRInG DRILL GUIDeS (VIX BITS)

Designed to drill centered screw holes for cabinet and builders hardware.

Part Number	Drill Diameter	Screw Size	Shank Diameter	Overall Length	Price
SE56401	5/64"	3 & 4	1/4"	3"	\$12.57
SE56401HX	5/64"	3 & 4	1/4" HEX	4"	\$13.07
SE76401	7/64"	5 & 6	1/4"	3-1/4"	\$11.15
SE76401HX	7/64"	5 & 6	1/4" HEX	4"	\$11.93
SE96401	9/64"	8, 9 & 10	1/4"	3-1/2"	\$11.72
SE96401HX	9/64"	8, 9 & 10	1/4" HEX	4"	\$13.12
SE116401	11/64"	12	3/8"	5"	\$49.97
SE116401HX	11/64"	12	1/4" HEX	4-1/2"	\$49.97
SE136401	13/64"	14	3/8"	4-1/2"	\$50.99
SE136401HX	13/64"	14	1/4" HEX	4-1/2"	\$50.99



VIX Self-Centering Drill Guides



SNAPPY Hex Shaft Self-Centering Drill Guides

RePLACeMenT DRILLS

Part Number	Drill Size	Price	Replacement for stock numbers	Shank Diameter	Overall Length
SE56402	5/64"	\$3.22	SE56401, SE56401HX	5/64"	2-1/2"
SE76402	7/64"	\$3.35	SE76401, SE76401HX	7/64"	2-7/18"
SE96402	9/64"	\$3.50	SE96401, SE96401HX	9/64"	3-1/8"
SE116402	11/64"	\$6.38	SE116401, SE116401HX	11/64"	4-1/8"
SE136402	13/64"	\$6.50	SE136401, SE136401HX	13/64"	4-1/8"

RePLACeMenT SPRInGS

Part Number	Price	Spring Size	Replacement for stock numbers
SE56403	\$1.14	5/64"	SE56401, SE56401HX
SE76403	\$1.14	7/64"	SE76401, SE76401HX
SE96403	\$1.29	9/64"	SE96401, SE96401HX
SE116403	\$2.95	11/64"	SE116401, SE116401HX
SE136403	\$2.99	13/64"	SE136401, SE136401HX



RePLACeMenT GUIDeS

Part Number	Price	Guide Size	Replacement for stock numbers
SE56404	\$3.08	5/64"	SE56401, SE56401HX
SE76404	\$2.72	7/64"	SE76401, SE76401HX
SE96404	\$2.86	9/64"	SE96401, SE96401HX
SE116404	\$9.58	11/64"	SE116401, SE116401HX
SE136404	\$10.35	13/64"	SE136401, SE136401HX



SOUTHEAST TOOL

3 wing • Cutters only
1 7/8" DIAMETER X 5/16" BORE
COUNTERSINK

Part Number	Decimal	Kerf Fractional	Price
FBL062-3	.062	1/16"	\$18.61
FBL093-3	.093	3/32"	\$20.00
FBL125-3	.125	1/8"	\$20.00
FBL157-3	.157	5/32"	\$20.00
FBL187-3	.187	3/16"	\$23.36
FBL250-3	.250	1/4"	\$23.36



FLB062-3A5

Arbors for Cutting Tools

Part Number	Shank Diameter	Arbor Diameter	Arbor Length	Overall Length	Price
SAR250	1/4"	5/16"	7/8"	2-3/8"	\$3.32
SAR375	3/8"	5/16"	7/8"	2-5/8"	\$8.69
SAR500	1/2"	5/16"	7/8"	2-3/8"	\$3.32
SAR500-1716	1/2"	5/16"	1 7/16"	3-1/16"	\$11.72



SAR250 NEW

Add A to the end of part number for arbor with bearing SBE125 (SAR250A).

(T&G Assembly)

Micro-Grain Solid Carbide Spiral Bits

2 FLUTE RIGHT HAND ROTATION

Upcut Part Number	Downcut Part Number	Cutting Diameter	Cutting Length	Shank Diameter	Overall Length	Price
SRU102	SRD202	3/32"	1/2"	1/4"	2"	\$19.54



Carbide-Tipped Beaded Picture Frame Molding Bit (3-1/16" o AL)

Part Number	Cutting Diameter	Cutting Length	Shank Diameter	Price
SE3315	3/4"	1-11/16"	1/2"	\$80.18

SBE130 Bearing



Carbide-Tipped Furniture/Box Maker Bit

Part Number	Cutting Diameter	Cutting Length	Shank Diameter	Overall Length	Price
SE3525SE3525	1-1/2"	1-5/8"	1/2"	3-15/16"	\$63.17

SBE115 Bearing



High Speed Steel - Finish Ground Router Blanks - 3" Overall Length

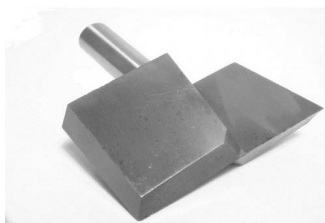

Part Number	Diameter	Cutting Length	Price
SEHSSRB-34	3/4"	1-1/2"	\$41.66
SEHSSRB-1	1"	1-1/2"	\$45.28
SEHSSRB-1	1-1/4"	1-1/2"	\$52.70
SEHSSRB-112	1-1/2"	1-1/2"	\$65.24
SEHSSRB-134	1-3/4"	1-1/2"	\$75.20
SEHSSRB-2	2"	1-1/2"	\$76.40
SEHSSRB-214	2-1/4"	1-1/2"	\$92.33
SEHSSRB-212	2-1/2"	1-1/2"	\$115.20
SEHSSRB-234	2-3/4"	1-1/2"	\$120.83
SEHSSRB-3	3"	1-1/2"	\$127.19

Router blanks provide the flexibility to create you own designs.

SOUTHEAST TOOL

Standard Reversible Insert Knives

PART#	DESCRIPTION	PRICE
2 sided 1 Hole		
SI-201215	20 x 12 x 1.5	\$24.39
SI-251215	25 x 12 x 1.5	\$38.88
4 sided 1 Hole		
SI-121215	12 x 12 x 1.5	\$24.34
SI-141420	14 x 14 x 2.0	\$22.58
SI-14614625	14.6 x 14.6 x 2.5	\$51.19
SI-151525	15 x 15 x 2.5 w/ 150mm Radius	\$53.95
2 sided 2 Hole		
SI-301215	30 x 12 x 1.5 14 CTC	\$28.31
SI-401215	40 x 12 x 1.5 26 CTC	\$40.61
SI-501215	50 x 12 x 1.5 26 CTC	\$42.46
SI-601215	60 x 12 x 1.5 26 CTC	\$61.09
4 sided 2 Hole (14 CTC) plunge		
SI-2958015	29.5 x 8 x 1.5	\$69.53
SI-2959015	29.5 x 9 x 1.5	\$57.44
SI-2951215	29.5 x 12 x 1.5	\$57.44
SI-301215P	30 x 12 x 1.5	\$57.44

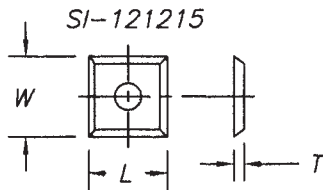

All insert Knives come in Boxes of 10

PART #	DESCRIPTION	PRICE
radius Knives		
SIR-121452L	12 x 14.5 x 2 LH 2mm Radius	\$182.03
SIR-121452R	12 x 14.5 x 2 RH 2mm Radius	\$182.03
radius Knives		
SIR-151452L	15 x 14.5 x 2 LH 3mm Radius	\$168.80
SIR-151452R	15 x 14.5 x 2 RH 3mm Radius	\$168.80
4 sided 2 Hole (26 CTC) plunge		
SI-3951215	39.5 x 12 x 1.5	\$69.85
4 sided 3 Hole (37 CTC)		
SI-501017	50 x 10 x 1.7	\$92.07
2 sided Back groove		
SI-305511BG	30 x 5.5 x 1.1 Back Groove	\$38.02
SI-405511BG	40 x 5.5 x 1.1 Back Groove	\$40.61
2 sided face groove		
SI-305511FG	30 x 5.5 x 1.1 Face Groove	\$37.56
SI-405511FG	40 x 5.5 x 1.1 Face Groove	\$38.67
SI-505511FG	50 x 5.5 x 1.1 Face Groove	\$44.66

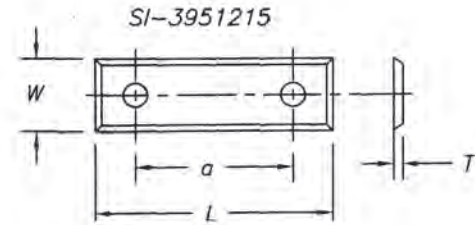

ChUCK, STyLe 1

For all types of machines where a 7/16"-14 threaded shank is needed.

Threaded shank 7/16"-14 Drill is held in place with a set screw.

Part Number	Hole Diameter	Outer Diameter	Overall Length	Rotational Direction
SE11125R	1/8"	5/8"	1-1/2"	right
SE11156R	5/32"	5/8"	1-1/2"	right
SE11187L	3/16"	5/8"	1-1/2"	left
SE11187R	3/16"	5/8"	1-1/2"	right
SE11218L	7/32"	5/8"	1-1/2"	left
SE11218R	7/32"	5/8"	1-1/2"	right
SE11250L	1/4"	5/8"	1-1/2"	left
SE11250R	1/4"	5/8"	1-1/2"	right
SE11281L	9/32"	5/8"	1-1/2"	left
SE11281R	9/32"	5/8"	1-1/2"	right
SE11312L	5/16"	7/8"	2-3/8"	left
SE11312R	5/16"	7/8"	2-3/8"	right
SE11375L	3/8"	7/8"	2-3/8"	left
SE11375R	3/8"	7/8"	2-3/8"	right
SE11393L	10mm	7/8"	2-3/8"	left
SE11393R	10mm	7/8"	2-3/8"	right
SE11437L	7/16"	7/8"	2-3/8"	left
SE11437R	7/16"	7/8"	2-3/8"	right
SE11500L	1/2"	7/8"	2-3/8"	left
SE11500R	1/2"	7/8"	2-3/8"	right



Chuck, Style 1

Your Choice \$22.00 Each.

SOUTHEAST TOOL

high-Speed Steel

Carving Rougher Bits



M2 Steel

Part Number	Diameter	Rotation	Shank	Price
SECR500RH	1/2"	RH	1/4"	\$18.58
SECR500LH	1/2"	LH	1/4"	\$18.58
SECR625RH	5/8"	RH	1/4"	\$18.58
SECR625LH	5/8"	LH	1/4"	\$18.58
SECR625RH-11	5/8"	RH	11mm	\$28.10
SECR625LH-11	5/8"	LH	11mm	\$28.10
SECR750RH	3/4"	RH	1/4"	\$20.37
SECR750LH	3/4"	LH	1/4"	\$20.37
SECR750RH-11	3/4"	RH	11mm	\$32.39
SECR750LH-11	3/4"	LH	11mm	\$32.39
SECR750RH-12	3/4"	RH	1/2"	\$24.02
SECR750LH-12	3/4"	LH	1/2"	\$24.02
SECR1000RH	1"	RH	1/4"	\$42.19
SECR1000LH	1"	LH	1/4"	\$42.19

Roundnose Carving Bits

high-Speed Steel



M2 Steel

Part Number	Diameter	Rotation	Shank	Price
SERC500RH	1/2"	RH	1/4"	\$29.03
SERC500LH	1/2"	LH	1/4"	\$29.03
SERC750RH	3/4"	RH	1/4"	\$43.47
SERC750LH	3/4"	LH	1/4"	\$43.47

Carving Pod Bits

high-Speed Steel



M2 Steel

Part Number	Diameter	Cutting Length	Rotation	Overall Length	Price
SEPD125LH	1/8"	3/4"	LH	3"	\$12.05
SEPD125RH	1/8"	3/4"	RH	3"	\$12.05
SEPD187LH	3/16"	1"	LH	3"	\$12.05
SEPD187RH	3/16"	1"	RH	3"	\$12.05
SEPD250LH	1/4"	1"	LH	3"	\$12.05
SEPD250RH	1/4"	1"	RH	3"	\$12.05
SEPD375LH	3/8"	1"	LH	3"	\$19.06
SEPD375RH	3/8"	1"	RH	3"	\$19.06

Square Corner Chisel



SE9600

Part Number	Radius	Price
SE9600	1/4"	\$19.06



Space Balls are 1/4" neoprene rubber.

PART	QUANTITY	PRICE
SPB 1000	1,000	\$21.90
SPB 5000	5,000	\$89.90 (\$17.98/K)
SPB 10000	10,000	\$154.00 (\$15.40/K)
SPB 25000	25,000	\$372.50 (\$14.90/K)
SPB 50000	50,000	\$625.00 (\$12.50/K)

ATTENTION MAKERS OF SOLID PANEL CABINET DOORS

This simple accepted expansion joint is the *inexpensive* solution to your age-old problem!

In addition to making the assembly process for Solid Panel Cabinet Doors easier, Space Balls also offer the following features to assure perfect assembly each and every time:

Space Ball Features:

- Automatically center panels in the assembling process.
- Expand and contract as the panel does due to various temperature conditions.
- Eliminate panel Rattle.
- Helps eliminate Cracking of glue joints.
- Space Balls will cut out most major call-backs on solid or flat panel doors.

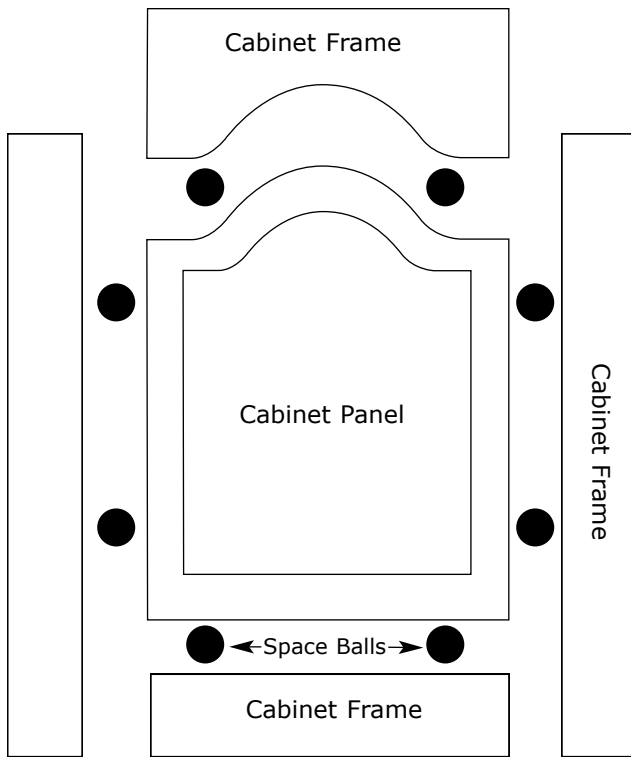

Space Balls are 1/4" neoprene rubber balls that are resilient to extreme temperatures. Typically in the winter, raised panels will shrink causing the fit between the panel and the frame to become loose. This addition of space between the two joints is enough to cause the frame to rattle, even from the slightest types of vibration such as walking. The materials used to make Space Balls allow for them to contract and expand when necessary allowing the cabinet door to retain it's true shape and fit. It is recommended that 8 to 10 Space Balls be used per door. Simply insert the balls into the groove between the panel and the frame, not between the fame pieces (see illustration on the left).

Cabinet Door Profiles and Space Balls shown are **not** Actual Size.

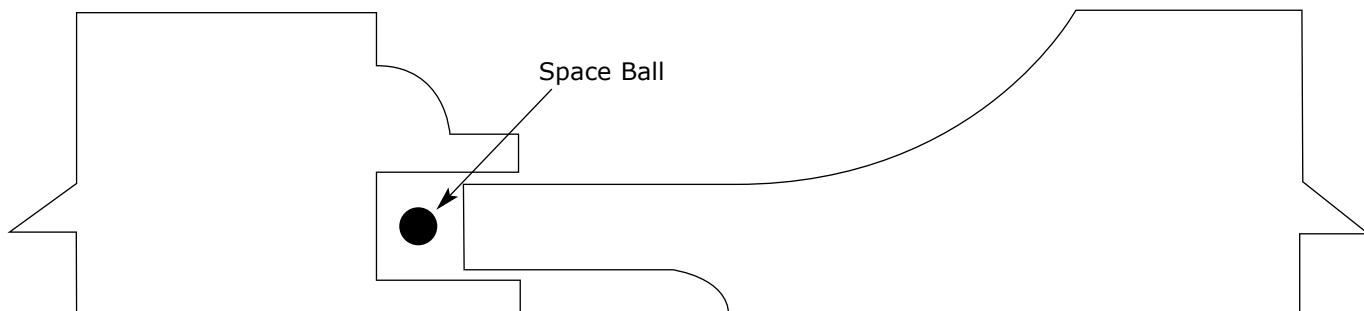

SUNMIGHT



- Production woodworking disc.
- Premium mineral A/O.
- Excellent life.
- Excellent sharpness of cut.
- Even scratch pattern on all wood species.
- Resistance to clogging, loading, pilling, and tearing on edges.

Available at a lower cost than any other brand!

Full tab release backer for protection against dust sticking to PSA.

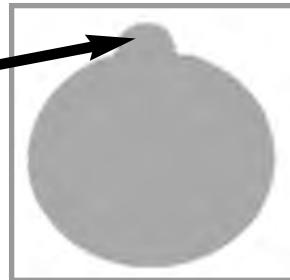

Film-backed production quality disc for furniture, woodworking. Provides a faster and sharper cutting performance and longer life than competitors' products. The result is an outstanding finish without scratch marks, clogging, loading, or pilling. **Sunmight** film-backed discs produce a perfect sanding surface every time.

**5" Gold Velcro
5 Hole - 50 Discs/Box**

PART	GRIT	PRICE
52205	60	\$17.88
52206	80	\$15.54
52207	100	\$13.81
52208	120	\$13.81
52209	150	\$13.81
52210	180	\$13.81
52211	220	\$13.81
52214	320	\$13.81
52216	400	\$13.81

**5" Gold Velcro
8 Hole - 50 Discs/Box**

PART	GRIT	PRICE
58105	60	\$17.18
58106	80	\$16.43
58107	100	\$14.62
58108	120	\$14.62
58109	150	\$14.62
58110	180	\$14.62
58111	220	\$14.62
58114	320	\$14.62
58116	400	\$14.62

**5" PSA Gold
No Hole - 100 Discs/Box**

PART	GRIT	PRICE
02105	60	\$28.38
02106	80	\$24.66
02107	100	\$21.77
02108	120	\$21.77
02109	150	\$21.77
02110	180	\$21.77
02111	220	\$21.77
02114	320	\$21.77
02116	400	\$21.77

Full release backer

SUNMIGHT**5" Film-Backed PSA Green
No Hole - 100 Discs/Box**

PART	GRIT	PRICE
01106	80	\$33.25
01107	100	\$29.77
01108	120	\$29.77
01109	150	\$29.77
01110	180	\$29.77
01111	220	\$29.77
01114	320	\$29.77
01116	400	\$29.77

Full release backer

**5" Gold PSA
5 Hole - 100 Discs/Box**

PART	GRIT	PRICE
52106	80	\$24.66
52107	100	\$21.77
52108	120	\$21.77
52109	150	\$21.77
52110	180	\$21.77
52111	220	\$21.77
52114	320	\$21.77
52116	400	\$21.77

**5" Gold Velcro
No Hole - 50 Discs/Box**

PART	GRIT	PRICE
02205	60	\$17.88
02206	80	\$15.54
02207	100	\$13.81
02208	120	\$13.81
02209	150	\$13.81
02210	180	\$13.81
02211	220	\$13.81
02214	320	\$13.81
02216	400	\$13.81

**6" Gold PSA
No Hole - 100 Discs/Box**

PART	GRIT	PRICE
02305	60	\$35.10
02306	80	\$30.50
02307	100	\$27.61
02308	120	\$27.61
02309	150	\$27.61
02310	180	\$27.61
02311	220	\$27.61
02314	320	\$27.61
02316	400	\$27.61

**6" Gold PSA
6 Hole - 100 Discs/Box**

PART	GRIT	PRICE
02706	80	\$30.50
02707	100	\$27.61
02708	120	\$27.61
02709	150	\$27.61
02710	180	\$27.61
02711	220	\$27.61
02714	320	\$27.61
02716	400	\$27.61

**6" Gold Velcro
6 Hole - 50 Discs/Box**

PART	GRIT	PRICE
02806	80	\$19.91
02807	100	\$17.93
02809	120	\$17.93
02809	150	\$17.93
02810	180	\$17.93
02811	220	\$17.93
02814	320	\$17.93
02816	400	\$17.93

SYSTI-MATIC

Budke Combination Blades - 15° Hook

PART	DIA.	TEETH	ARBOR	KERF	PLATE	PRICE
8BB35-085	8	35	5/8	.131	.085	\$55.66

BB - 4 Tooth and Raker Grind (4ATB 1 Raker) Planer

The Budke Combination Blade is the most popular selling combination available. It's the ideal all-purpose shop blade because it does so many jobs so well. Use it to crosscut or rip solid woods as well as for cutting plywood and particle boards. A top value, the Budke Blade is our most popular combination blade and has hefty carbide tips that can be resharpened many times

Compound Mitre Saw Blades

PART	DIA.	TEETH	ARBOR	KERF	PLATE	PRICE
8.5PT40-065N	8.5	40	5/8	.105	.065	\$103.00
8.5MC60-065N	8.5	60	5/8	.105	.065	\$71.72
10RT60-085N	10	60	5/8	.131	.085	\$71.49

PT - Alternate Top Bevel Grind with 10° Hook Angle

PC - Triple Chip Grind with 10° Hook Angle

RM and MC - Triple Chip Grind with Neg. 6° Hook Angle

PT/N and RT - Alternate Top Bevel Grind with Neg. 6° Hook Angle

Compound Miter Blades specially designed for 8.5", 10" and 12" Machines. These miter designed Commercial Quality Blades produce superb results on all types of compound miter machines. (PC) Triple Chip model is excellent for cutting vinyl siding. (RM, MC) Non-Ferrous Metal cutting models are ideal for aluminum siding applications.

Plymaster Blades - 15° Hook

PART	DIA.	TEETH	ARBOR	KERF	PLATE	PRICE
8PM44-085	8	44	5/8	.131	.085	\$58.61
14PM72-109	14	72	1	.161	.109	\$180.46

PM (8", 10" and 12" blades) - 10 Tooth and Raker Grind.

PM 14" blade - 8 Tooth and Raker Grind

The Ultimate Table-Saw Blade for cabinet makers and demanding craftsmen. The plymaster is our best cabinet blade to date. It's ideal for the experienced woodworker who wants smooth, chip-free cuts in all types of materials including plywood, particle boards, hard or soft woods.

For Maximum Performance:

8" Blades: 1" Max. Material Thickness

10" Blades: 1-1/2" Max. Material Thickness

12" Blades: 2-1/2" Max. Material Thickness

14" Blades: 3" Max. Material Thickness

Radial Arm Saw Blades

PART	DIA.	TEETH	ARBOR	KERF	PLATE	PRICE
8RM48-085N	8	48	5/8	.131	.085	\$65.18
10RM60-085N	10	60	5/8	.131	.085	\$67.28
10RT60-085N	10	60	5/8	.131	.085	\$71.49

RM - Triple Chip Grind with Neg. 6° Hook Angle

RT - Alternate Top Bevel Grind with Neg. 6° Hook Angle

Specially designed for safe, smooth cuts on all radial arm saws. Negative hook angle minimizes chances of grabbing or over feeding. Choose the RT Alternate Top Bevel Grind for crosscutting wood and cutoff work, the RM Triple Chip Grind blade is ideal for all-purpose cutting. (Also excellent for cutting non-ferrous metals on chop saws.) For the smoothest performance on thicker material use lower tooth count and for thinner material use higher tooth count.



Double Mitre Blades

PART	DIA.	TEETH	ARBOR	KERF	PLATE	PRICE
10DW80-098N	10	80	5/8	.122	.098	\$101.27
10DW100-098N	10	100	5/8	.122	.098	\$144.77
10DM80-098NG	10	80	5/8	.128	.098	\$91.20
12DW80-110N	12	80	5/8	.135	.110	\$168.54
12DW80-110N-1	12	80	1	.135	.110	\$120.34
12DW100-110N	12	100	5/8	.135	.110	\$137.54
12DW100-110N-1	12	100	1	.135	.110	\$140.66
12DM80-110NG	12	80	5/8	.122	.110	\$130.03
12DM80-110NG-1	12	80	1	.122	.110	\$105.66
12DM100-110NG	12	100	5/8	.122	.110	\$137.97
12DM100-110NG-1	12	100	1	.122	.110	\$140.66
10DM-100-100NG	10	100	5/8	.100	.130	\$106.78

DM - Triple Chip Grind / ALUMINATOR™ / HSR™ GOLD / non-ferrous

DW - 4 ATB and 1 Raker / Wood

Used on production style double mitre machines such as CTD and Pistorius, in wood and non-ferrous applications. The double Mitre blade is the perfect choice for picture frame shops, window and door manufacturers or anywhere that production type mitre machines are used. The 'DW' provides chip free mitres in wood. Use the 'DM' for clean burr-free cuts in aluminum or other non-ferrous metals. ALUMINATOR™ design.

CALL FOR AVAILABILITY

Systi-Matic is out of business. Make your purchase of these fine blades while they are still available.

SYSTI-MATIC

Glue Joint Rip Blades

PART	DIA.	TEETH	ARBOR	KERF	PLATE	PRICE
14GR36-120	14	36	1	.172	.172	\$91.04

GR - Triple Chip Grind with 22° Hook Angle
 MR - Triple Chip Grind with 22° Hook Angle W/KY

Precision Trim Blades

PART	DIA.	TEETH	ARBOR	KERF	PLATE	PRICE
10PT60-085	10	60	5/8	.131	.085	\$64.76
10PT100-085	10	100	5/8	.131	.085	\$122.40
14PT60-109	14	60	1	.161	.109	\$125.03
14PT80-109	14	80	1	.161	.109	\$120.27
14PT100-109	14	100	1	.161	.109	\$132.86
15PT100-090TL	15	100	1	.135	.090	\$148.48
16PT60-20	16	60	1	.172	.120	\$150.04
16PT80-120	16	80	1	.172	.120	\$159.14
16PT100-120	16	100	1	.172	.120	\$188.51
18PT60-134	18	60	1	.190	.134	\$130.13
10PT60-060TL	10	60	5/8	.060	.093	\$87.20
10PT80-070TL	10	80	5/8	.070	.099	\$109.41

PT - Alternate Top Bevel Grind with 10° Hook Angle

For exceptionally smooth end trimming and crosscutting in all types of solid wood and plywood. Super finished alternating bevel teeth cleanly sever wood fibers. This is the ideal production blade for high-quality commercial crosscut applications. In general, select higher tooth quantities for smoother cuts.

Heavy Duty Rip Blades

PART	DIA.	TEETH	ARBOR	KERF	PLATE	PRICE
8HR24-085	8	24	5/8	.131	.085	\$50.48
10HR10-095	10	10	5/8	.145	.095	\$58.24
14HR24-120	14	24	1	.172	.120	\$81.27
16HR30-134	16	30	1	.190	.134	\$119.90

HR - Flat Top Grind with 22° Hook Angle

Rugged, High-Production Rip Blades for all types of solid wood. These blades produce a good finish and are well-suited for both soft and hard wood applications. In general, select higher tooth quantities for power feed applications and use lower tooth quantities on hand-fed machines. Excellent blades for stock break down

CALL FOR AVAILABILITY

Systi-Matic is out of business. Make your purchase of these fine blades while they are still available.

Solid Surface Solutions

PART	DIA.	TEETH	ARBOR	KERF	PLATE	PRICE
7.25SS40-072	7-1/4	40	5/8	.072	.120	\$61.58
10SS60-075	10	60	5/8	.075	.130	\$106.10
12SS72-095	12	72	1	.095	.120	\$112.17
14SS72-109	14	72	1	.109	.149	\$171.39
8SS40-085	8	40	5/8	.085	.120	\$71.50
8SS48-085	8	48	5/8	.085	.120	\$72.28
10SS48-085	10	48	5/8	.085	.120	\$103.38
16SS80-120	16	80	1	.120	.160	\$147.00

SS - Modified Top Bevel Grind with Negative 6° to Positive 10° Hook Angle.

NEW! Hybrid carbide alloy for longer life and durable edge. New expansion slot design keeps the blade running truer and cooler. New technologically advanced saw tip geometry for smoother cuts, giving you less ganding and finishing time. Bottom line, solid profits through Systi-Matic® solid solutions.

Plastic and Trim Blades

PART	DIA.	TEETH	ARBOR	KERF	PLATE	PRICE
8PC60-085	8	60	5/8	.131	.085	\$70.12
9PC60-085	9	60	5/8	.131	.085	\$112.68
10PC60-085	10	60	5/8	.131	.085	\$63.69
10PC80-085	10	80	5/8	.131	.085	\$74.13
14PC60-109	14	60	1	.161	.109	\$131.48
14PC100-109	14	100	1	.161	.109	\$132.85
16PC80-120	16	80	1	.172	.120	\$159.42
10PC60-070TL	10	60	5/8	.070	.099	\$87.29
10PC80-070TL	10	80	5/8	.070	.099	\$103.15

PC - Triple Chip and Raker Grind with 10° Hook Angle

Specially designed for cutting plastics, plastic/particle board overlays, as well as trimming of solid wood and plywood. These blades produce smooth, chip-free cuts on plastics and overlay materials. Minimum burning and melting on heat-sensitive plastics. Higher tooth quantities should be used on thin and brittle materials, lower tooth quantities for thicker and low-melting point materials. Too many teeth tend to cause excessive friction, melting, blade gumming and rough, ragged cuts. Feel the chips - if they're hard, you're generating too much heat. Try feeding the material faster. And if it doesn't work, you definitely should use a blade with fewer teeth. Many users select this blade specifically for mitre cutting of hardwoods.

Aluminator™ HSR™ Gold Non-Ferrous Metal Blades

PART	DIA.	TEETH	ARBOR	KERF	PLATE	PRICE
9MC60-085G	9	60	5/8	.125	.085	\$88.42
10MC60-098NG	10	60	5/8	.128	.098	\$74.26
10MC80-085	10	80	5/8	.125	.085	\$80.84
14MC80-12NG	14	80	1	.150	.120	\$134.41
15MC100-090GTL	15	100	1	.135	.090	\$162.58
16MC100-134NG	16	100	1	.160	.134	\$184.42
10DM100-100NG	10	100	5/8	.100	.130	\$106.78

THE FOLLOWING 2 BLADES ARE NOT HSR™ GOLD

PART	DIA.	TEETH	ARBOR	KERF	PLATE	PRICE
10MC100-085	10	100	5/8	.125	.085	\$111.20

MC and DM - Triple Chip Grind with Neg. Hook Angle (12° Hook on 12MC)

SYSTI-MATIC IS OUT OF BUSINESS.
 SUPPLIES LIMITED TO STOCK ON HAND.

SUPER FINISH TRIM SAW BLADE

Part #	Diameter	Teeth Grind	Kerf	Plate	Hook Angle	Bore	Price
12SF60-095	12"	60 ATB	.095	.145	10°	1"	\$103.86

TFE BANDITS (RED COATED)

Part #	Diameter	Teeth Grind	Kerf	Plate	Hook Angle	Bore	Price
8PT(TF) 60-065	8"	60 ATB	.065	.089	10°	5/8"	\$122.31
8.5PT(TF)60-065	8.5"	60 ATB	.065	.089	10°	5/8"	\$120.87
10GR(TF)24-080	10"	24 TCG	.080	.104	22°	5/8"	\$74.70
10PM(TF)55-080	10"	55 Raker	.080	.104	15°	5/8"	\$130.05
12PM(TF)66-095	12"	66 Raker	.095	.119	15°	1"	\$158.52
12PT(TF)100-080	12"	100 ATB	.080	.104	10°	1"	\$176.82
14PT(TF)100-080	14"	100 ATB	.080	.104	10°	1"	\$199.09
15PT(TF)100-090 15"	15"	100 ATB	.090	.114	10°	1"	\$197.84

VERTICAL PANEL (VP GRIND)

Part #	Diameter	Teeth Grind	Kerf	Plate	Hook Angle	Bore	Application	Price
8VP60-085M 8VP60-060N	8"	60 VP	.085	.118	6°	5/8"	Safety Speed Cut, Milwaukee	\$96.90
220VP64-085 220VP64-30	220mm	64	.085	.126	10°	30mm	Holz-Her	\$137.58
250VP60-085N	250mm	60	.085	.126	-6°	30mm	Interwood	\$116.79
300VP72-085N	300mm	72	.085	.126	-6°	30mm	Streibig Holz-Her	\$123.76

SYSTI-MATIC SAW BLADES (CONT.)

LAMINATE - VENEER (NEGATIVE K LAND GRIND)						
Part #	Diameter	Teeth	Kerf	Plate	Bore	Price
10LV60-085	10"	60	.085	.128	5/8"	\$75.02
14LV80-085	14"	80	.109	.161	5/8"	\$199.00

MELAMINE - VENEER							
Part #	Diameter	Teeth	Kerf	Plate	Hook Angle	Bore	Price
10MV60-086	10"	60	.085	.128	-6°	5/8"	\$78.61
10MV80-086	10"	80	.085	.128	-6°	5/8"	\$87.29

GANG RIP SAW BLADES							
Part #	Diameter	Teeth Grind	Kerf	Plate	Hook Angle	Bore	Price
305/12GR24-080	305mm/12"	24 TCG	.080	.125	22°	1"	\$83.78

RADIAL ARM SAW BLADES							
Part #	Diameter	Teeth Grind	Kerf	Plate	Hook Angle	Bore	Price
8RT48-085N	8"	48 ATB	.085	.131	-6°	5/8"	\$67.49
10RT48-085N	10"	48 ATB	.085	.131	-6°	5/8"	\$69.08
10RM48-085N	10"	48 TCG	.085	.131	-6°	5/8"	\$69.08

Part #	Diameter	Teeth Grind	Kerf	Plate	Hook Angle	Bore	Price
20CT60-148	20"	60 2-ATB, 1-Raker	.148	.204	22°	1"	\$172.54

HITACHI CIRCULAR SAW BLADES (Carbide Tipped)							
Part #	Diameter	# Teeth	Grind	Arbor	Kerf	Plate	Price
726101	12"	90		1"			\$49.99
725206	10"	72		5/8"			\$39.99
998840**	8.5"	24		5/8"			\$25.65
991039**	6.25"	28		5/8"	1/16"		\$19.95

**QUANTITIES LIMITED TO STOCK ON HAND.

T-TOOL

ISO/SK 30 and BT TOOLHOLDERS for CNC ROUTERS					
Part #	Description	C	A	D	Spindle/CNC
SPZ.30DIN05032ERR	SK30 ER32 HSD	50	50	50	HSD/VARIOUS
SPZ.30DN06440ERR	SK30 ER40 HSD	50	64	63	HSD/VARIOUS
SPZ.30DIN06332ERR	SK30 ER32 COLOMBO	50	63	50	COLOMBO
SPZ.30DIN06425OZR	SK30 SYOZ25 ANDERSON	50	64	60	ANDERSON/OMNITECH
SPZ.30ISO05032ERR	ISO30 ER32 CMS	46	50	50	CMS
SPZ.30BT06032ERR	BT30 ER32 SHODA	46	60	50	SHODA
SPZ.30BTW06032ERR	BT30 ER32 KOMO	46	60	50	KOMO W/O DOGS

HSK 63F TOOLHOLDERS for CNC ROUTERS					
Part #	Description	C	A	D	SPINDLE/CNC
SPZ.HSK63F07032ERR	HSK-63F ER32 A70	63	70	50	VARIOUS
SPZ.HSK63F07640ERR	HSK-63F ER40 A76	63	76	63	VARIOUS
SPZ.HSK63F09040ERR	HSK-63F ER40 A90	63	90	63	VARIOUS
SPZ.HSK63F08025OZR	HSK-63F SYOZ25 A80	63	80	60	ANDERSON/OMNITECH

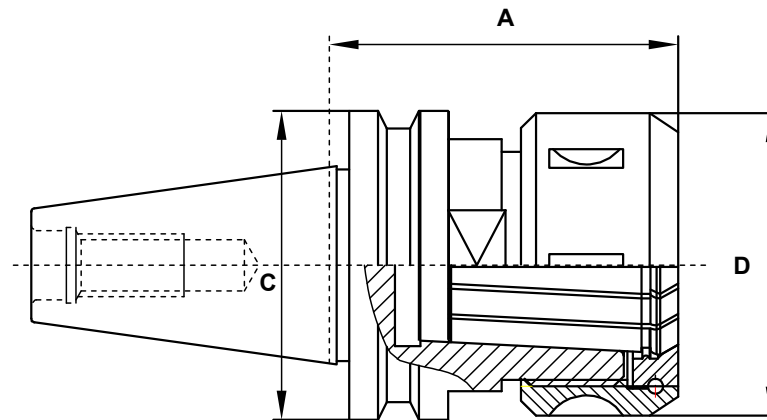

T-TOOL

COLLET NUTS for CNC ROUTERS – MADE IN GERMANY

Part #	Description	A	B	C
SPAMU20UMERPROF	ER20 COLLET NUT	35	19	M25x1.5
SPAMU25UMER	ER25 COLLET NUT	42	20	M32x1.5
SPAMU32UMER	ER32 COLLET NUT	50	23	M40x1.5
SPAMU40UMER	ER40 COLLET NUT	63	25	M50x1.5
SPAMU1825OZK	SYOZ 25 BEARING NUT	60	30	M48x2.0
SPAMU32UMERKM	ER32 BEARING NUT	50	26	M40x1.5
SPAMU40UMERKM	ER40 BEARING NUT	63	29	M50x1.5

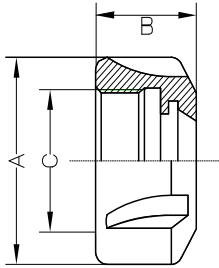

PULL STUDS FOR CNC ROUTERS – MADE IN GERMANY

Part #	Description	CNC
BO30DIN69872A	SK30 PULLSTUD	WEEKE, BUSSELLATO, COLOMBO (billet), ANDI
BO30SCMMOR10	SK30 PULLSTUD	SCM / MORBIDELLI – TOOTHED HOLDERS
BO30BIERUN12	SK30 PULLSTUD	BIESSE/HSD BUTTONHEAD
BO30AIBE12	SK30 PULLSTUD	ALBERTI, MASTERWOOD (COLOMBO – ball)
BO30CMS12	SK30 PULL STUD	CMS
BO30BTKOMO	BT30 PULLSTUD	BT30 KOMO
BO30BT45	BT30 PULLSTUD	BT30 45° HEIAN
BO30BT60	BT30 PULLSTUD	BT30 60° SHODA

COLLETS FOR CNC ROUTERS – MADE IN GERMANY

Part #	Collets - All Sizes	Price
	ER20	\$26.50
	ER25	\$28.00
	ER32	\$28.00
	ER40	\$31.00
	SYOZ20	\$37.00
	SYOZ25	\$28.00

T-TOOL

T- TOOLS COLLET ACCESSORIES

Bearing nuts for collets DIN 6499 Type ER/ESX

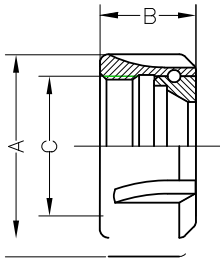

Type	Part #	A	B	C
KM/ER 25	SPAMU25UMERKM	42	22	M 32X1.5
KM/ER 32	SPAMU32UMERKM	50	26	M 40X1.5
KM/ER 40	SPAMU40UMERKM	63	29	M 50X1.5

Ball- bearing nuts for collets DIN 6388

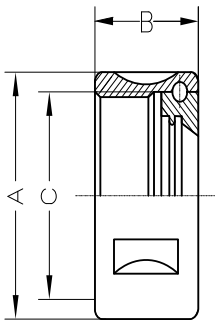

Type (right)	Part #	A	B	C
OZ. 1825 K	SPAMU1825OZK	60	30	M 48x2

Pull studs Alberti SK 30 (Colombo—clamping by balls)

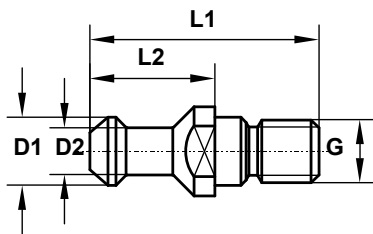

Type	Part #	G	D1	D2	L1	L2
SK 30	BO30AIBE12	M 12	13	9	24	44

Pull studs after MAS - BT - KOMO

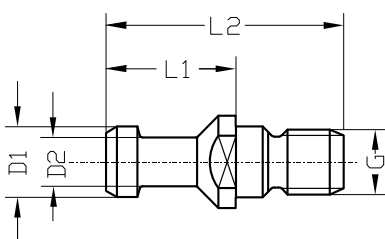

Type	Part #	G	D1	D2	L1	L2
BT 30	BO30BTKOMO	M 12	13	9	24	44

TECHNIKS

ISO 30 and BT Toolholders for CNC Routers

PART	DESCRIPTION	D	A	F	N	COLLET NUT	WRENCH	SPINDLE
42213-W-50	HSD ISO 30xER 32	50	50	15.9	50	46132	04616	HSD
42213-W-63	Colombo ISO 30xER 32	50	60	15.9	50	46132	04616	Colombo
NT-54300130	SK-30xSYOZ 25 ANDI	50	70	15.9	60	03638	03691	ANDI
16121	BT30xER 32 KOMO	46	60	20	50	46132	04616	KOMO

- Balanced to 18,000 RPM at G2.5
- Inspection report included for accuracy and balance.

Call for Pricing 1-800-288-7483

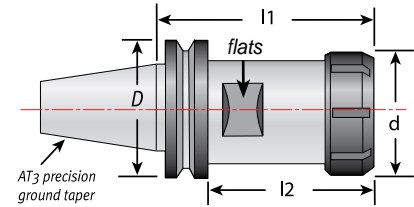

Note: The "l1" dimension is measured with the collet in the nut. Dimensions are in millimeters.

HSK 63F Toolholders for CNC Routers

PART	DESCRIPTION	D	A	F	N	COLLET NUT	WRENCH
30000	HSK 63FxER 32	63mm	70mm	36mm	50mm	46132	04616
30001	HSK 63FxER 40	63mm	76mm	46mm	63mm	46140	04617
30005	HSK 63FxER 40	63mm	125mm	46mm	63mm	46140	04617
31025F	HSK 63FxSYOZ 25	63mm	80mm	38mm	60mm	83632	03691

- Nut is included with each toolholder.
- Each nut has HSK spindle.

Call for Pricing 1-800-288-7483

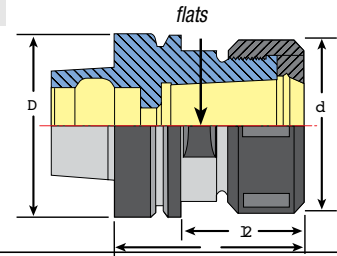

ER Precision Collet Dimensions

PART	D	L
ER16	0.83"	1.24"
ER20	0.67	1.08"
ER25	1.02"	1.34"
ER32	1.31"	1.57"
ER40	1.61"	1.81"
SYOZ 20	0.78"	1.34"
SYOZ 25	1.38"	2.06"

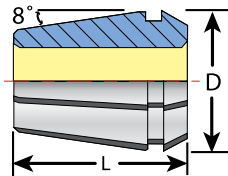

ER40	PRICE	SYOZ20	PRICE	ER25	ER32	SYOZ25	DRILL SHANK	PRICE
04240 - 1/8	\$31.00	83512 - 1/8	\$37.00	04225 - 1/8	04232 - 1/8	83868 - 1/8	1/8"	\$28.00
04240 - 3/16	\$31.00	83512 - 3/16	\$37.00	04225 - 3/16	04232 - 3/16	83868 - 3/16	3/16"	\$28.00
04240 - 1/4	\$31.00	83512 - 1/4	\$37.00	04225 - 1/4	04232 - 1/4	83868 - 1/4	1/4"	\$28.00
04240 - 5/16	\$31.00	83512 - 5/16	\$37.00	04225 - 5/16	04232 - 5/16	83868 - 5/16	5/16"	\$28.00
04240 - 3/8	\$31.00	83512 - 3/8	\$37.00	04225 - 3/8	04232 - 3/8	83868 - 3/8	3/8"	\$28.00
04240 - 7/16	\$31.00	83512 - 7/16	\$37.00	04225 - 7/16	04232 - 7/16	83868 - 7/16	7/16"	\$28.00
04240 - 1/2	\$31.00	83512 - 1/2	\$37.00	04225 - 1/2	04232 - 1/2	83868 - 1/2	1/2"	\$28.00
04240 - 5/8	\$31.00	-----	\$37.00	04225 - 5/8	04232 - 5/8	83868 - 5/8	5/8"	\$28.00
04240 - 3/4	\$31.00	-----	\$37.00	-----	04232 - 3/4	83868 - 3/4	3/4"	\$28.00
04240 - 1	\$31.00	-----	\$37.00	-----	-----	83868 - 1	1"	\$28.00
04240 - 10	\$31.00	83512 - 10	\$37.00	04225 - 10	04232 - 1	83868 - 10	10mm	\$28.00
04240 - 25	\$31.00	-----	\$37.00	-----	-----	83868 - 25	25mm	\$28.00

TECHNIKS

CALL FOR AVAILABILITY

Tightening Stand for ISO, HSK63F and BT30 Toolholders



PART	DESCRIPTION	TOOL HOLDER USED FOR	PRICE
NTS-ISO30-36	30 taper with 36mm wrench flats	12213-W-63, 12213-W-90	\$350.00
NTS-ISO30-38	30 taper with 38mm wrench flats	NT-5400130	\$350.00
NTS-ISO30-47	30 taper with 47mm wrench flats	12213-W-50	\$350.00
NTS-HSK63F-36	HSK63F with 36mm wrench flats	30000	\$350.00
NTS-HSK63F-38	HSK63F with 38mm wrench flats	41025	\$350.00
NTS-HSK63F-46	HSK63F with 46mm wrench flats	30001	\$350.00

- Fastest Tightening stand available.
- New design for easy access to pull studs from bottom
- Constructed of precision machined anodized alloy.
- Outstanding strength, speed and durability.
- Securely bolts right on CNC machine or workbench.

Collet Nuts for CNC Routers

PART	DESCRIPTION	D	B	WRENCH	M	PRICE
46125	ER25 HS Coated Nut	1.65"	0.83"	04615	M32 x 1.5	\$57.00
46132	ER32 HS Coated Nut	1.97"	0.91"	04616	M40 x 1.5	\$49.00
46140	ER40 HS Coated Nut	2.48"	1.02"	04617	M50 x 1.5	\$52.00
83634	SYOZ 20 Coated Nut	1.38"	0.78"	22220	M27 x 1.5	\$65.00
83632	SYOZ 25 Coated Nut	2.36"	1.81"	04691	M98 x 2.0	\$67.00

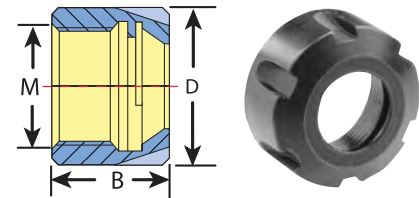

Pull Studs for CNC Routers

PART	TYPE	D	d1	d2	d3	L	I1	I2	O	T	PRICE	
750-19	KOMO 30-A	12.5	17	13	9	12.5	44	23.4	18.2	15°	M12	\$32.00
49001	DAT 30-A17	17	13	9	13	44	24	19	15°	M12	\$14.00	
49001-45	Colombo 30-Ball	17	12.8	9	13	44	24	19	45°	M12	\$22.00	
49019	HSD ISO 30	17	12	8	13	44	23.9	---	radius	M12	\$23.00	

Call Ballew Saw and Tool if you don't see the Pull Stud you need listed here.

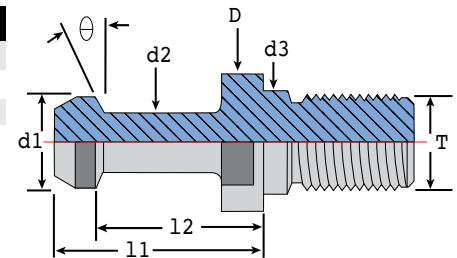

Universal Torque Wrenches



PART	TORQUE RANGE	LENGTH	SPIGOT	PRICE
200 TH	30 - 150 ft./lbs.	16.5	16mm Round	\$372.00
300 TH	45 - 228 ft./lbs.	21.5	16mm Round	\$444.00

Prevent injuries and extend tool life: A Top quality torque wrench is essential to correctly tighten collet nuts and pull studs. Preset wrenches available on request.

Collet Keys

PART	COLLET NUT SIZE	WRENCH TYPE	MAX. TORQUE	PRICE
04603-25	ER25 Spanner	Slotted	95ft/lbs.	\$38.00
04604-32	ER32 Spanner	Slotted	125ft/lbs.	\$39.00
04605-40	ER40 Spanner	Slotted	140ft/lbs.	\$45.00
03690-25	SYOZ 25/TG 100	Hook	100ft/lbs.	\$40.00



TECHNIKS

eR Spanner wrenches

ER Hex Hand Wrench

PART	DESCRIPTION	PRICE
04608	ER 11 A-Wrench	\$14.00
04609	ER 16 A-Wrench	\$14.00
04610	ER 20 A-Wrench	\$21.00



Hex A-Wrench

ER Slotted Hand Wrench

PART	DESCRIPTION	PRICE
04613	ER 16 E-Wrench	\$37.00
04614	ER 20 E-Wrench	\$37.00
04615	ER 25 E-Wrench	\$16.00
04616	ER 32 E-Wrench	\$21.00
04617	ER 40 E-Wrench	\$25.00



Slotted E-Wrench

ER Mini Hand Wrenches

PART	DESCRIPTION	PRICE
04620	ER 8 M-Wrench	\$13.00
04621	ER 11 M-Wrench	\$13.00
04622	ER 16 M-Wrench	\$14.00
04623	ER 20 M-Wrench	\$15.00
04624	ER 25 M-Wrench	\$15.00



Mini M-Wrench

Hook Style TG Hand Wrenches

PART	DESCRIPTION	PRICE
04018	TG 75 Wrench	\$37.00
83691	TG 100 SYOZ 25 Wrench	\$22.00
22220	SYOZ 20 Wrench	\$45.00



TG Hook Wrench

Collet Keys ER Slotted

PART	DESCRIPTION	PRICE
04603-25	ER 25	\$38.00
04604-32	ER 32	\$39.00
04605-40	ER40	\$45.00



Collet Keys Hook

PART	DESCRIPTION	PRICE
03690-25	TG 100/SYOZ 25	\$40.00



TIGRA

Also Available at Ballew Saw and Tool Knives for:

- Centorlock • Centrofix
- Centrostar • Quick Fix • Bull Dozer

TERMINUS

14mm Height - 2.55mm Thickness

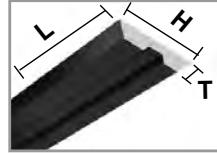

Carbide

HSS

L (mm)	HW T10MG Part#	Price	Black Oxide Standard (M2) Part #	Price
50	100796	\$47.58	114601	\$5.42
60	100803	\$54.01	114602	\$6.49
80	100804	\$66.72	114603	\$8.66
100	100805	\$79.12	114604	\$10.83
110	100806	\$84.59	114605	\$11.91
120	100807	\$89.60	114606	\$13.01
130	055496	\$93.96	114607	\$14.08
136	107532	\$96.80	114608	\$14.74
140	100808	\$96.92	114609	\$15.15
150	100809	\$101.16	114610	\$16.25
160	100811	\$105.23	114611	\$17.32
170	100812	\$108.98	114612	\$18.42
180	100813	\$112.30	114613	\$19.50
190	100814	\$115.55	114614	\$20.57
200	100815	\$118.59	114615	\$21.67
210	100816	\$121.48	114616	\$22.74
220	100817	\$124.01	114617	\$23.84
230	054752	\$126.18	114618	\$24.91
240	100818	\$128.39	114619	\$25.99
250	100819	\$130.07	114620	\$27.08
255	107533	\$131.09	114621	\$27.62
260	100820	\$133.12	114622	\$28.16
270	100821	\$136.54	114623	\$29.26
275	107534	\$139.88	114624	\$29.79
280	100822	\$141.30	114625	\$30.33
300	100823	\$146.93	114626	\$32.50
310	055497	\$147.80	114627	\$33.57
330	107535	\$152.66	114628	\$35.75
350	100824	\$157.05	114629	\$37.92
360	100825	\$161.44	114630	\$38.99
400	100826	\$173.51	114631	\$43.33
410	055498	\$177.80	114632	\$44.41
420	100828	\$181.95	114633	\$45.48
430	100829	\$186.11	114634	\$46.58
450	100830	\$188.79	114635	\$48.75
480	100940	\$195.44	114636	\$52.00
500	104977	\$196.69	114637	\$54.14
510	055499	\$200.61	114638	\$55.24
520	100831	\$204.42	114639	\$56.32
530	100832	\$208.22	114640	\$57.41
610	055500	\$223.77	114641	\$66.08
620	100833	\$227.34	114642	\$67.15
630	100834	\$230.90	114643	\$68.25
640	100835	\$234.47	114644	\$69.32
650	055501	\$237.95	114645	\$70.39
710			114646	\$76.91
810			114647	\$87.74
1050			114648	\$113.75

TERSA 10mm Height - 2.5mm Thickness

Carbide











HSS

L (mm)	HW T10MG Part#	Price	Black Oxide Standard (M2) Part #	Price
60	100847	\$ 37.08	100395	\$5.16
75	104212	\$ 39.44	107545	\$5.99
80	100848	\$ 45.72	100396	\$6.26
90	104398	\$ 51.43	107546	\$6.79
95	104211	\$ 53.05	107547	\$7.16
100	055509	\$ 54.78	100397	\$7.54
110	100849	\$ 60.10	100398	\$8.17
115	105071	\$ 62.69	104630	\$8.52
120	100851	\$ 65.42	100399	\$8.96
125	104022	\$ 70.30	107548	\$9.09
130	055510	\$ 70.76	100400	\$9.41
135	103823	\$ 74.68	103821	\$9.83
140	104766	\$ 75.76	104613	\$10.18
145	104210	\$ 77.35	107549	\$10.53
150	100852	\$ 79.90	100401	\$10.70
160	103943	\$ 83.56	102716	\$11.42
170	100853	\$ 88.69	100402	\$11.63
180	100854	\$ 92.03	100403	\$12.32
185	105070	\$ 94.57	102774	\$12.76
190	104399	\$ 95.23	104808	\$13.02
200	105698	\$101.88	104243	\$13.46
210	100855	\$105.00	100404	\$14.12
220	104589	\$109.90	104566	\$14.44
230	055511	\$114.88	100405	\$14.73
235	103824	\$118.33	101718	\$15.05
240	104043	\$120.08	101720	\$15.13
250	100856	\$124.75	100406	\$15.25
260	100857	\$129.70	100407	\$15.86
265	104573	\$132.20	104326	\$16.15
270	101673	\$134.70	102982	\$16.47
280	100858	\$139.58	100408	\$16.85
300	100859	\$143.47	100409	\$18.04
310	055512	\$145.15	100410	\$18.65
320	107550	\$148.20	104687	\$19.26
330	100861	\$152.98	100411	\$19.83
350	100862	\$155.62	100412	\$20.59
360	100863	\$161.54	100413	\$21.17
400	100864	\$166.10	100414	\$22.33
410	055513	\$184.43	100415	\$22.77
415	107551	\$189.01	105267	\$23.14
420	100865	\$191.29	100416	\$23.34
430	055514	\$193.59	100417	\$23.91
450	100866	\$198.15	100418	\$25.28
500	100867	\$202.91	100419	\$27.86
510	055515	\$220.43	100420	\$28.42
520	055516	\$224.80	100421	\$28.98
530	100868	\$229.19	100422	\$29.18
540	100869	\$233.57	100423	\$29.73
600	104720	\$237.96	103994	\$32.29
610	055517	\$252.65	100424	\$32.75
630	055518	\$256.71	100425	\$33.83
635	102179	\$265.10	103912	\$34.10
640	100870	\$267.20	100426	\$35.12
650	055519	\$269.29	100427	\$36.08
710			114119	\$38.69
810			113435	\$44.15
1050			114599	\$55.12

Edge Profile Bits

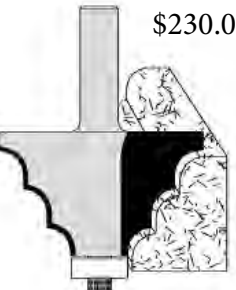
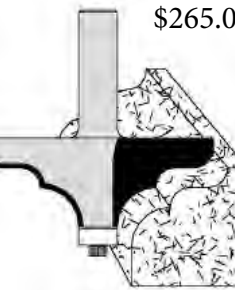
FOR SOLID SURFACE
 Carbide Tipped – 1/2" Shank Diameter
 – 2 Flutes with Ball Bearing Guide

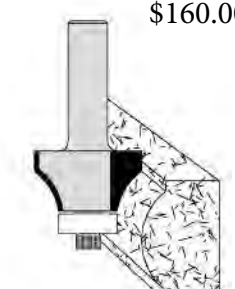
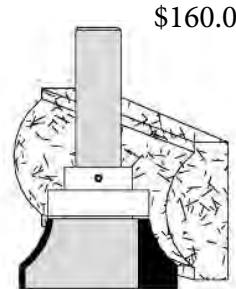

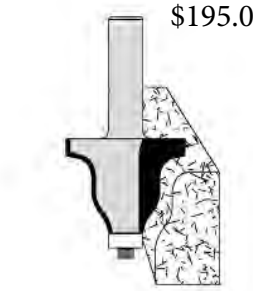
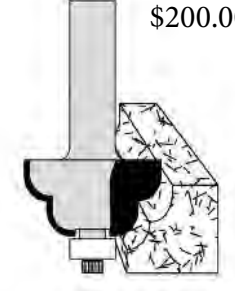
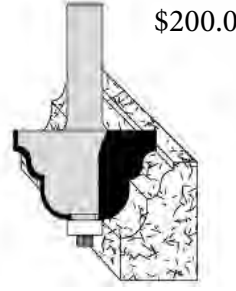
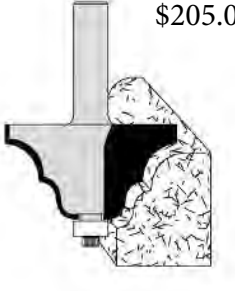
 <p>\$215.00</p> <p>MERRICK 60-101 3" CUTTING DIAMETER, 1-1/8" CUTTING LENGTH</p>	 <p>\$255.00</p> <p>BAYSIDE 60-104 3" CUTTING DIAMETER, 1-3/8" CUTTING LENGTH</p>	 <p>\$210.00</p> <p>BALDWIN 60-102 2-5/8" CUTTING DIAMETER, 1" CUTTING LENGTH</p>	 <p>\$190.00</p> <p>MONT AUK 60-105 2-1/2" CUTTING DIAMETER, 1-1/8" CUTTING LENGTH</p>
 <p>\$245.00</p> <p>HILLSIDE 60-103 2-3/4" CUTTING DIAMETER, 1-1/4" CUTTING LENGTH</p>	 <p>\$210.00</p> <p>HUNTER 60-111 2-1/2" CUTTING DIAMETER, 1-1/2" CUTTING LENGTH</p>	 <p>\$230.00</p> <p>HILLCREST 60-109 2-3/4" CUTTING DIAMETER, 1-5/8" CUTTING LENGTH</p>	 <p>\$265.00</p> <p>HAMILTON 60-114 3" CUTTING DIAMETER, 1-1/8" CUTTING LENGTH</p>
 <p>\$265.00</p> <p>HANOVER 60-115 3-1/8" CUTTING DIAMETER, 1" CUTTING LENGTH</p>	 <p>\$160.00</p> <p>N. OCEAN 60-122 1-3/8" CUTTING DIAMETER, 3/4" CUTTING LENGTH</p>	 <p>\$160.00</p> <p>S. OCEAN 60-123 1-3/4" CUTTING DIAMETER, 3/4" CUTTING LENGTH</p>	 <p>\$190.00</p> <p>HAMPTON 60-108 2-1/2" CUTTING DIAMETER, 1-1/4" CUTTING LENGTH</p>
 <p>\$195.00</p> <p>BEVERLY 60-128 1-3/4" CUTTING DIAMETER, 1-1/4" CUTTING LENGTH</p>	 <p>\$200.00</p> <p>BOSWELL 60-129 1-1/2" CUTTING DIAMETER, 3/4" CUTTING LENGTH</p>	 <p>\$200.00</p> <p>BENTLY 60-125 2" CUTTING DIAMETER, 1-1/8" CUTTING LENGTH</p>	 <p>\$205.00</p> <p>BANGOR 60-130 2-1/2" CUTTING DIAMETER, 1-1/4" CUTTING LENGTH</p>

\$180.00

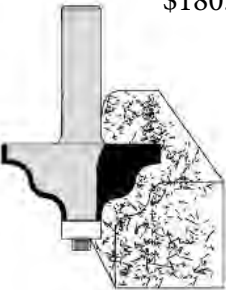

BROOKS 60-131
 2" CUTTING DIAMETER,
 7/8" CUTTING LENGTH

\$170.00

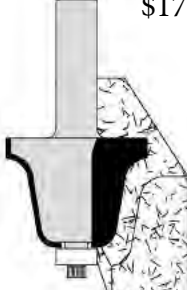

HIALEAH 60-133
 1-3/4" CUTTING DIAMETER,
 1-1/4" CUTTING LENGTH



Plunge Cutting Router Bits

Carbide Tipped

Comp No.	Stock No.	Flutes	Cutting Diameter [A]	Shank Diameter	Cutting Length [C]	Overall Length [D]	Price
10-265	6-8-C1	1	3/8"	1/2"	1"	2-3/4"	\$22.00
10-280	7-8-D2	2	7/16"	1/2"	1-1/4"	3"	\$27.00
10-285	11	2	1/2"	1/2"	1"	2-5/8"	\$22.25
10-315	8-8-F1L	1	1/2"	1/2"	2"	4-1/4"	\$30.20
10-320	15	2	1/2"	1/2"	2"	4-1/4"	\$30.10
10-325	8-8-H2L	2	1/2"	1/2"	2-1/2"	4-1/2"	\$41.25

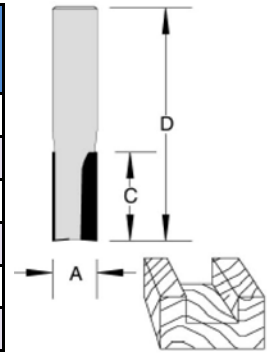

Steel Ball Bearing Guides

For general use as replacement bearings. Use where bearing contact on material surface is not critical.

Comp No.	Stock No.	Inside Diameter [A]	Outside Diameter [B]	Price
12-100	B-2	5/16"	1/2"	\$11.50
12-115	B-5	1/4"	3/8"	\$12.00
12-155	B-13	5/16"	0.945"	\$10.00
12-160	B-14	1/4"	5/8"	\$7.00
12-172	B-20	1/2"	7/8"	\$16.50
12-174	B-24	15MM	24MM	\$20.00

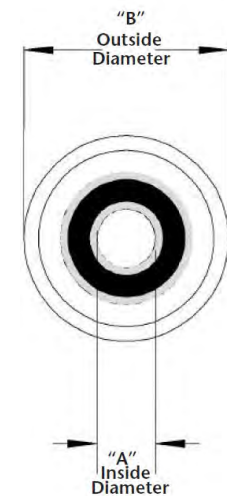

Nylon Bushed Ball Bearing Guides

Used on slotting cutter assemblies to control depth of cut in material

Comp No.	Stock No.	Inside Diameter [A]	Outside Diameter [B]	Price
12-551	VT16-5	5/16"	1"	\$48.00
12-552	VT18-5	5/16"	1-1/8"	\$48.00
12-553	VT20-5	5/16"	1-1/4"	\$48.00
12-555	VT23-5	5/16"	1-7/16"	\$48.00
12-556	VT24-5	5/16"	1-1/2"	\$48.00
12-557	VT26-5	5/16"	1-5/8"	\$48.00
12-558	VT28-5	5/16"	1-3/4"	\$48.00
12-559	VT30-5	5/16"	1-7/8"	\$48.00
12-560	VT32-5	5/16"	2"	\$48.00

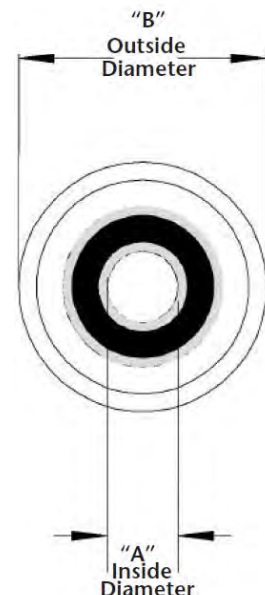



Vel-Vet Touch™ Bearing Guide

Designed not to mark or scratch the surface of the material. Suggested applications are Solid Surfaces, High Gloss Laminates or on any surface that is easily scratched.

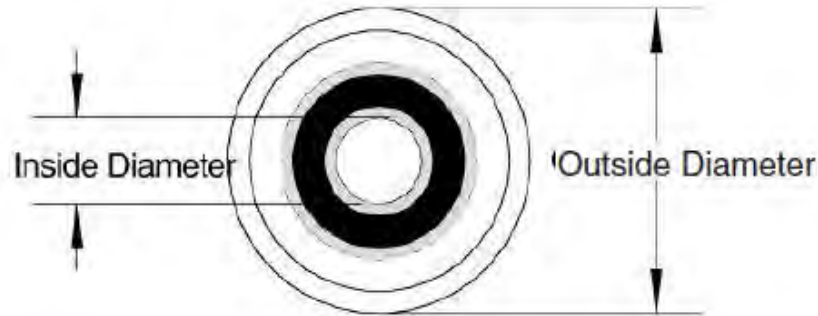

Comp No.	Stock No.	Inside Diameter [A]	Outside Diameter [B]	Degrees	Replacement Screws	Price
12-195	VT-195	1/4"	1"	-----	12-832	\$24.00
12-307	VTA-8-3	3/16"	1/2"	-----	12-825	\$20.00
12-324	VT-324	1/4"	13/16"	-----	12-837	\$24.00
12-340	VT-12-4	1/4"	3/4"	-----	12-837	\$22.00
12-365	VT-14-4	1/4"	7/8"	-----	12-837	\$22.00
12-390	VT-16-4	1/4"	1"	-----	12-837	\$22.00
12-395	VT-12-5	1/4"	3/4"	5	12-837	\$23.50
12-405	VT-12-10	1/4"	3/4"	10	12-837	\$23.50
12-425	VT-15-5	1/4"	15/16"	5	12-837	\$23.50
12-485	VT-14-5	1/4"	7/8"	5	12-837	\$23.50
12-495	VT-14-15	1/4"	7/8"	15	12-837	\$23.50
12-510	VT-14-10	1/4"	7/8"	10	12-837	\$23.50
12-515	VT-16-5 R	1/4"	1"	5	12-837	\$29.00
12-517	VT-16-7 R	1/4"	1"	7	12-837	\$26.00
12-520	VT-16-5	1/4"	1"	5	12-837	\$23.50
12-525	VT-16-10	1/4"	1"	10	12-837	\$23.50
12-535	VT-835	1/4"	15/16"	-----	12-832	\$22.00
12-536	VT-836	1/4"	15/16"	-----	12-832	\$22.00
12-540	VT-16-30	1/4"	1"	30	12-832	\$22.00
12-545	VT-24/B-18	1/2"	1-1/2"	-----	-----	\$30.00
12-550	VT-30/B-18	1/2"	1-1/2"	30	-----	\$33.00
12-606	VT-606	1/4"	15/16"	-----	12-837	\$22.00
12-607	VT-607	1/4"	15/16"	-----	12-837	\$22.00

Note: 12-307 is an assembly that includes a B-9 ball bearing and high hat steel bushing



Flush Trim Bits

Carbide Tipped - with Ball Bearing Guide

Comp No.	Stock No.	Flutes	Cutting Diameter [A]	Shank Diameter	Cutting Length [C]	Number of Bearings	Price
14-150	13B	2	1/2"	1/2"	1-1/2"	1	\$35.50
14-160	15B	2	1/2"	1/2"	2"	1	\$39.25

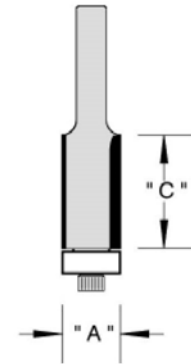

Core Box Bits

Carbide Tipped - 2 Flutes

Comp No.	Stock No.	Cutting Diameter [A]	Shank Diameter	Cutting Length [C]	Overall Length [D]	Radius [R]	Price
19-120	COR-3-8	3/8"	1/2"	3/8"	2"	3/16"	\$36.50
19-150	COR-6-8	3/4"	1/2"	5/8"	2-1/4"	3/8"	\$46.25
19-155	COR-7-4	7/8"	1/4"	5/8"	2"	7/16"	\$48.00

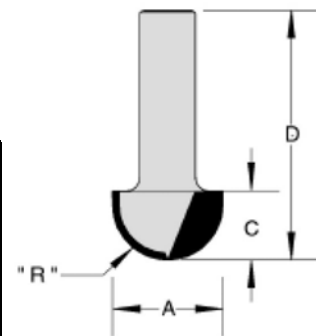

Flush Trim Bits

*TO CUT SOLID SURFACE
Carbide Tipped 1/2" Shank Diameter - 2 Flutes*

Comp No.	Stock No.	Price
14-212	19BVT	For 1/2" or 3/4" thick top \$58.00

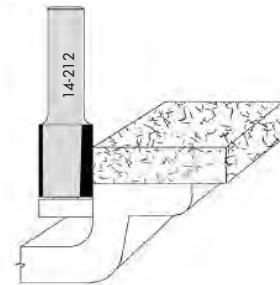

Cove Backsplash Bits

Carbide Tipped - 1/2" Shank Diameter

Comp No.	Stock No.	Cutting Diameter [A]	Cutting Length [C]	Overall Length [D]	Radius [R]	Price
19-220	COR-6-8L	3/4"	1/2"	3-1/4"	1/4"	\$49.00

These tools have extended length shanks, and are designed for use in a coving router to fabricate a coved backsplash in solid surface materials.

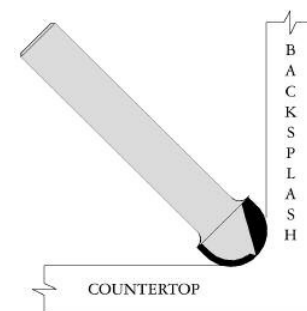

Plunge Cutting Rounding Over Bits

Carbide Tipped - 2 Flutes

Comp No.	Stock No.	Cutting Diameter [A]	Shank Diameter	Cutting Length [C]	Overall Length [D]	Radius [R]	Small Diameter [a]	Price
22-100	PRO-2-4	3/8"	1/4"	1/8"	1-7/8"	1/8"	1/8"	\$35.50
22-105	PRO-2-8	3/8"	1/2"	1/8"	2"	1/8"	1/8"	\$37.75

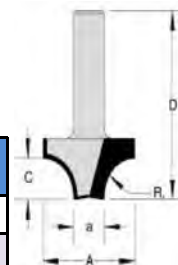



Rounding Over Bits

Carbide Tipped – 2 Flutes with Ball Bearing Guide

Comp No.	Stock No.	Cutting Diameter [A]	Shank Diameter	Cutting Length [C]	Radius [R]	Price
22-365	RO-8-4	1-1/2"	1/4"	3/4"	1/2"	\$50.00
22-390	RO-16-8	2-1/2"	1/2"	1-1/4"	1"	\$148.00

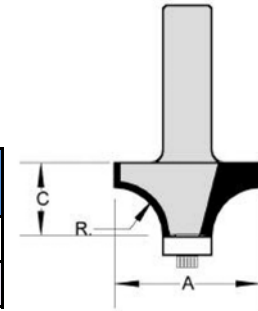

Edge Face Cove Bit

*To Cut Solid Surface
Carbide Tipped – 2 Flutes*

Comp No.	Stock No.	Cutting Diameter [A]	Shank Diameter	Cutting Length [C]	Depth of Cove [E]	Price
22-802	EFCB-5-8VT	1"	1/2"	5/8"	1/8"	\$90.00

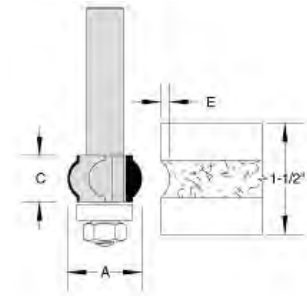

Drainboard Bits

*for Routing Drainboard Countertops
Carbide Tipped – 1/2" Shank Diameter - 2 Flutes*

Comp No.	Stock No.	Cutting Diameter [A]	Shank Diameter	Cutting Length [C]	Depth of Cove [E]	Price
30-050	DB-8-8-2R	1/2"	1/2"	1/2"	1/8"	\$44.00

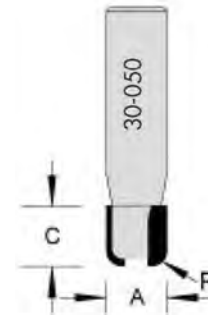

Counter Top Bits

*NO DRIP DESIGN
Carbide Tipped – 1/2" Shank Diameter - 2 Flutes*

Comp No.	Stock No.	Price
30-102	CND-8-8VT	w/VEL-VET TOUCH™ Bearing Guide \$97.50

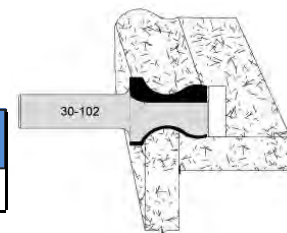

Rounding Over Undermount Bowl Bits

*TO CUT SOLID SURFACE
Carbide Tipped - 1/2" Shank Diameter – 2 Flutes*

Comp No.	Stock No.	Used on Avonite®, Corian®, Fountainhead® and Formica® Bowls, Transolid® and Hi-Macs® Sinks	Price
30-166	CRST10-16-8VT	1/2" Radius for 1" thick top	\$145.00

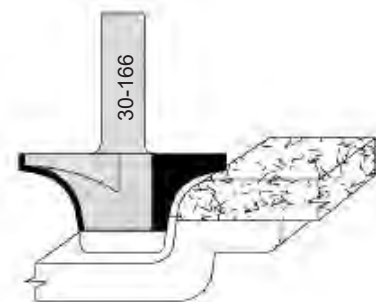



"L" Shape Counter Top Bits

*NO DRIP DESIGN TO CUT SOLID SURFACE Carbide Tipped
- 1/2" Shank Diameter - 2 Flutes*

Comp No.	Stock No.	Shank Diameter	Price
30-115	CNDL-12-8	1/2"	\$67.00

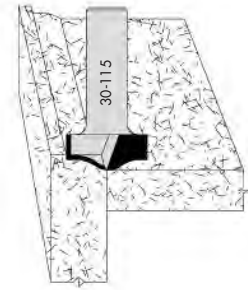

Euro-Topmount Router Bit Set

*TO CUT SOLID SURFACE
Carbide Tipped - 1/2" Shank Diameter - 2 Flutes*

Comp No.	Stock No.		Price
30-310	TMOG-24	Ogee Form Bit, 2 Flutes	\$67.00
30-315	TM-15	Bevel bit, 2 Flutes	\$78.00

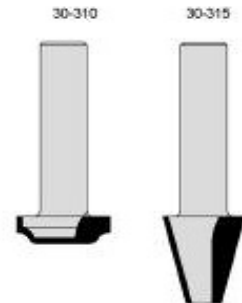

Rounding Over Undermount Bowl Bits

*TO CUT DUPONT CORIAN®
Carbide Tipped - 1/2" Shank Diameter - 2 Flutes*

Comp No.	Stock No.	For 'Bowls 'No. '802, '809, '810, '871	Price
30-140	CRST20-8-8VT	1/2" Radius for 1/2" thick top	\$149.00
30-145	CRST20-12-8VT	1/2" Radius for 3/4" thick top	\$150.00

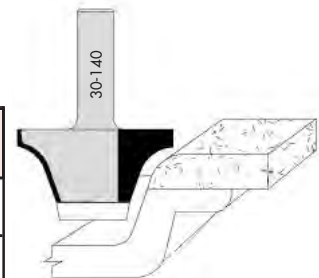

Rounding Over Undermount Bowl Bits

*TO CUT SOLID SURFACE
Carbide Tipped - 1/2" Shank Diameter - 2 Flutes*

Comp No.	Stock No.	Used on Avonite®, Corian®, Fountainhead® and Formica® Bowls, Transolid® and Hi-Macs® Sinks	Price
30-155	CRST10-8-8VTR	1/2" Radius for 1/2" thick top	\$156.00

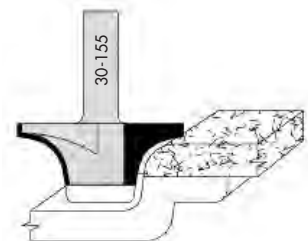

NOTE: TOOLS SUPPLIED WITH RADIUS BEARING AND RECESSED SCREW FOR LIMITED CLEARANCE APPLICATIONS SUCH AS FAUCET DECKS AND SHALLOW BOWL DIVIDES ON DOUBLE BOWL SINKS



Bevel Undermount Bowl Bits

TO CUT SOLID SURFACE
Carbide Tipped - 1/2" Shank Diameter - 2 Flutes

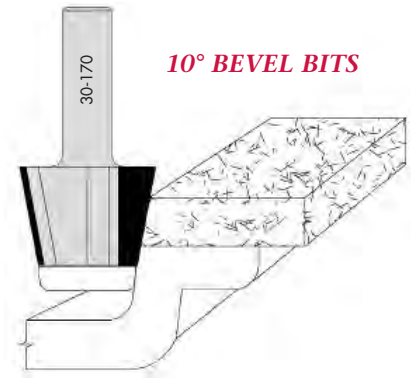

10° BEVEL BITS

Comp No.	Stock No.	Used on Avonite®, Cerata®, Corian®, Sinks and Bowls	Price
30-170	CBST10-CVTR	For 1/2" or 3/4" thick top	\$135.00



Overhang Cut-Out Trim Bits

TO CUT SOLID SURFACE
Carbide Tipped 1/2" Shank Diameter - 2 Flutes

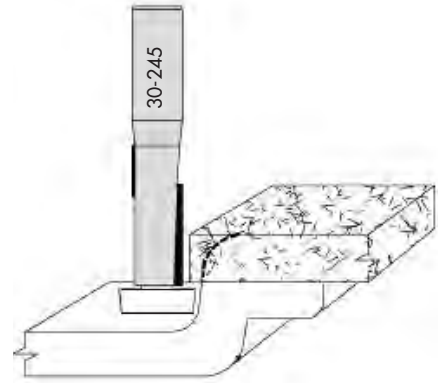

Comp No.	Stock No.	Price
30-245	SURB-8-12-5° For 1/8" Overhang	\$63.00
30-255	SURB-8-15-5° For 7/32" Overhang	\$63.00



Overhang Trim Bits

TO CUT SOLID SURFACE
Carbide Tipped - 1/2" Shank Diameter - 2 Flutes

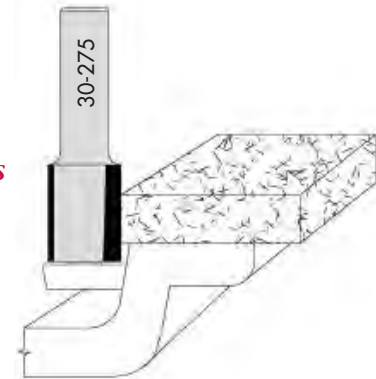

Comp No.	Stock No.	Price
30-275	CO19BVT For 1/2" or 3/4" thick top	\$59.50



Rounding Over Bits

Assembly Carbide Tipped - 1/2" Shank Diameter - 2 Flutes used in combination with above 30-110 CNDL-12-4, 30-115 CNDL-12-8

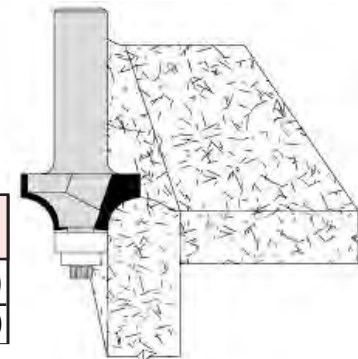

Comp No.	Stock No.	Price
30-347	CRO-5-4VT 1/4" Shank x 5/16" Radius	\$57.00
30-352	CRO-5-8VT 1/2" Shank x 5/16" Radius	\$59.00



Bull Nose Router Bit Set

TO CUT SOLID SURFACE COUNTER TOP
Carbide Tipped – 1/2" Shank Diameter – 2 Flutes

Rounding Over Bit

Comp No.	Stock No.		Price
30-382	CRO-12-8VT	3/4" Radius for 1 1/2" thick top	\$91.00

NOTE: WHEN ORDERING WITH STEEL BEARING, DROP THE VT FROM THE STOCK NO. AND GO DOWN TWO NUMBERS. EXAMPLE: CRO-12-8 (30-380).

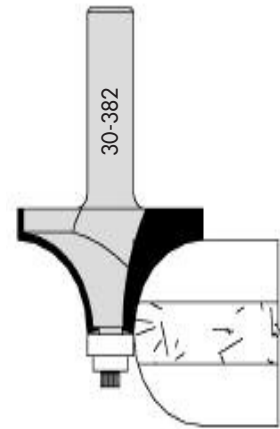

4 Wing Bowl Removal Bits

Carbide Tipped – 1/2" Shank Diameter
These tools are used to remove a damaged solid surface bowl from the countertop.

Comp No.	Stock No.	Description	D	Price
30-465	CPC-250-8	For all Bowls except Corian®	1-1/16"	\$165.00
30-470	CPC-187-8	For Corian® Bowls only	15/16"	\$140.00

NOTE: MAXIMUM RECOMMENDED ROUTER-OPERATING SPEED NOT TO EXCEED 12,000 RPM.

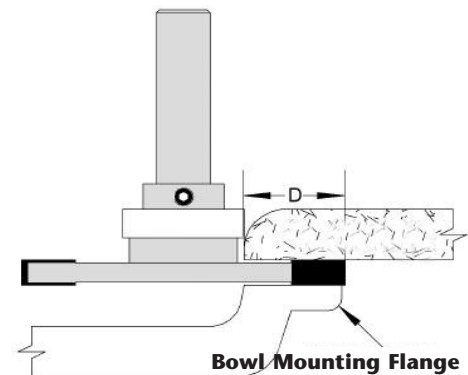

Bull Nose Bit

TO CUT SOLID SURFACE
Carbide Tipped - 1/2" Shank Diameter

Comp No.	Stock No.		Price
30-605	SUBN-8-12-4VT	To cut Avonite,® Cerata®, Surell® Lavatory Bowls & Sinks	\$154.00

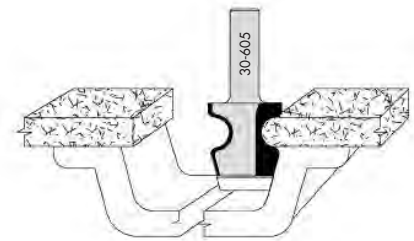

Rounding Over Undermount Bowl Bit

for SUR ELL® Bowls and Sinks
Carbide Tipped - 1/2" Shank Diameter

Comp No.	Stock No.		Price
30-615	SURO 8-12-6VT	For 1/2" and 3/4" thick top	\$135.00

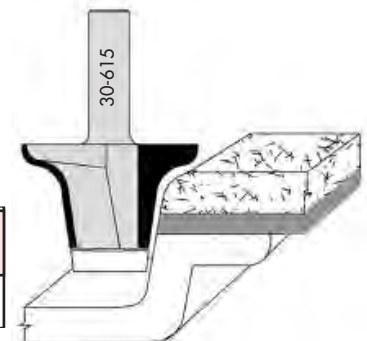



Rounding Over Undermount Bowl Bit

for 835 & 836 COR IAN® BOWLS
Carbide Tipped – 1/2" Shank Diameter – 2 Flutes

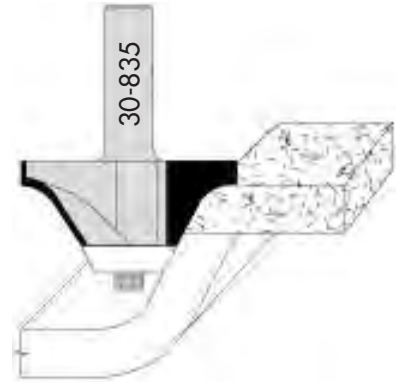

Comp No.	Stock No.		Price
30-835	CRST-835	For Bowl # 835	\$134.00
30-836	CRST-836	For Bowl #836	\$134.00



Face Inlay Bits

with Steel Ball Bearing Guide
Carbide Tipped – 1/2" Shank Diameter - 2 Flutes

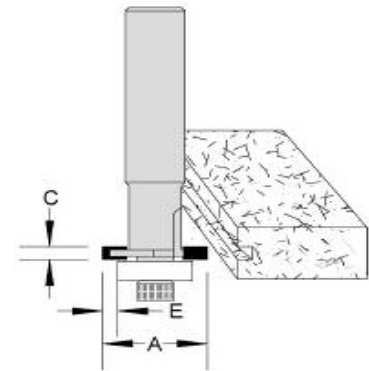

Comp No.	Stock No.	Cutting Diameter [A]	Shank Diameter	Kerf [C]	Inlay depth [E]	Price
30-203	CGT-2-8-3	7/8"	1/2"	1/8"	3/16"	\$45.50



Solid Surface Bits

These tools are designed to fabricate EOS™
3cm thick material.

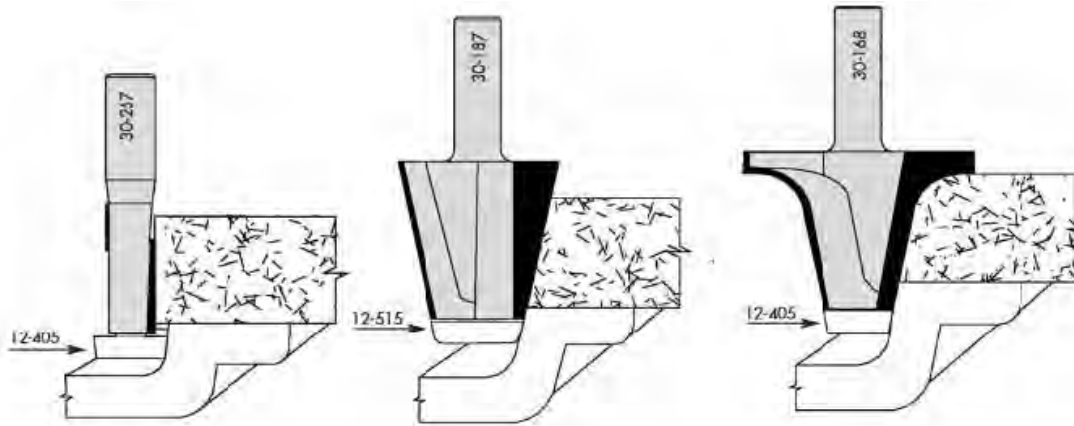

Comp No.	Stock No.	Shank Diameter	Degree	Price
30-168	CRST-12-20-8VT	1/2"		\$ 205.00
30-187	CBST-12-EEVTR	1/2"	12	\$ 150.00
30-257	ST-13B	1/2"		\$ 65.00

Vortex Tool - Solid Carbide Bits

Single Edge Finishers

Part #	Description	CED	CEL	SHK DIA	OAL	Price
830	SC SE Upcut Finisher	1/4	7/8	1/4	2 1/2	\$24.28
835	SC SE Upcut Finisher	5/16	7/8	3/8	3	\$40.86
840	SC SE Upcut Finisher	3/8	1 1/4	3/8	3	\$40.86
850	SC SE Upcut Finisher	1/2	1 1/4	1/2	3	\$70.31
930	SC SE Downcut Finisher	1/4	7/8	1/4	2 1/2	\$24.28
935	SC SE Downcut Finisher	5/16	7/8	3/8	3	\$40.86
940	SC SE Downcut Finisher	3/8	1 1/4	3/8	3	\$40.86
950	SC SE Downcut Finisher	1/2	1 1/4	1/2	3	\$70.31



Two Flute Upcut Roughing Tool

Part #	Description	CED	CEL	SHK DIA	OAL	Price
1040	SC DE Upcut Rougher	3/8	1 1/4	3/8	3	\$69.25
1040L	SC DE Upcut Rougher Left Hand	3/8	1 1/4	3/8	3	\$85.65
1050	SC DE Upcut Rougher	1/2	1 1/4	1/2	3	\$81.17
1050L	SC DE Upcut Rougher Left Hand	1/2	1 1/4	1/2	3	\$100.29
1055	SC DE Upcut Rougher	1/2	1 1/2	1/2	3 1/2	\$84.28
1055L	SC DE Upcut Rougher Left Hand	1/2	1 1/2	1/2	3 1/2	\$103.97
1060	SC DE Upcut Rougher	1/2	1 3/4	1/2	3 1/2	\$97.56
1065	SC DE Upcut Rougher	1/2	2 1/8	1/2	4	\$115.88
1065L	SC DE Upcut Rougher Left Hand	1/2	2 1/8	1/2	4	\$142.90
1070	SC DE Upcut Rougher	5/8	2 1/8	5/8	4	\$171.53
1070L	SC DE Upcut Rougher Left Hand	5/8	2 1/8	5/8	4	\$211.60
1080	SC DE Upcut Rougher	3/4	2 1/2	3/4	5	\$228.55



Two Flute Downcut Roughing Tool

Part #	Description	CED	CEL	SHK DIA	OAL	Price
1140	SC DE Downcut Rougher	3/8	1 1/4	3/8	3	\$69.25
1150	SC DE Downcut Rougher	1/2	1 1/4	1/2	3	\$81.17
1155	SC DE Downcut Rougher	1/2	1 1/2	1/2	3 1/2	\$84.28
1160	SC DE Downcut Rougher	1/2	1 3/4	1/2	3 1/2	\$97.56
1160L	SC DE Downcut Rougher Left Hand	1/2	1 3/4	1/2	3 1/2	\$130.08
1165	SC DE Downcut Rougher	1/2	2 1/8	1/2	4	\$115.88
1170	SC DE Downcut Rougher	5/8	2 1/8	5/8	4	\$171.53
1180	SC DE Downcut Rougher	3/4	2 1/2	3/4	5	\$228.55



Two Flute Upcut Chipbreaker Tool

Part #	Description	CED	CEL	SHK DIA	OAL	Price
1440	SC DE Upcut Chipbreaker	3/8	1 1/4	3/8	3	\$68.94
1450	SC DE Upcut Chipbreaker	1/2	1 1/4	1/2	3	\$96.30
1455	SC DE Upcut Chipbreaker	1/2	1 1/2	1/2	3 1/2	\$100.22
1460	SC DE Upcut Chipbreaker	1/2	1 3/4	1/2	3 1/2	\$106.54
1465	SC DE Upcut Chipbreaker	1/2	2 1/8	1/2	4	\$112.77
1470	SC DE Upcut Chipbreaker	5/8	2 1/8	5/8	4	\$218.93
1470L	SC DE Upcut Chipbreaker	5/8	2 1/8	5/8	4	\$270.46
1480	SC DE Upcut Chipbreaker	3/4	2 1/2	3/4	5	\$239.32



Two Flute Downcut Chipbreaker Tool

Part #	Description	CED	CEL	SHK DIA	OAL	Price
1540	SC DE DC Chipbreaker	3/8	1 1/4	3/8	3	\$68.94
1540L	SC DE DC Chipbreaker	3/8	1 1/4	3/8	3	\$85.19
1550	SC DE DC Chipbreaker	1/2	1 1/4	1/2	3 1/2	\$96.30
1555	SC DE DC Chipbreaker	1/2	1 1/2	1/2	3 1/2	\$100.22
1560	SC DE DC Chipbreaker	1/2	1 3/4	1/2	3 1/2	\$106.54
1565	SC DE DC Chipbreaker	1/2	2 1/8	1/2	4	\$112.77
1570	SC DE DC Chipbreaker	5/8	2 1/8	5/8	4	\$218.93
1580	SC DE DC Chipbreaker	3/4	2 1/2	3/4	5	\$238.40



Two Flute Upcut Finishing Tool

Part #	Description	CED	CEL	SHK DIA	OAL	Price
1203	SC DE Upcut Finisher	3mm	12mm	6mm	64mm	\$18.67
1204	SC DE Upcut Finisher	1/16	1/4	1/8	1 1/2	\$21.84
1205	SC DE Upcut Finisher	4mm	16mm	6mm	64mm	\$18.67
1206	SC DE Upcut Finisher	5mm	20mm	6mm	64mm	\$19.79
1208	SC DE Upcut Finisher	6mm	25mm	6mm	64mm	\$21.25
1210	SC DE Upcut Finisher	1/8	1/2	1/4	2	\$18.78
1210L	SC DE Upcut Finisher Left Hand	1/8	1/2	1/4	2	\$23.35
1212*	DE UC Finishing Spiral	1/8	7/8	1/4	2 1/2	\$23.50
1215	SC DE Upcut Finisher	5/32	9/16	1/4	2	\$18.78
1220	SC DE Upcut Finisher	3/16	5/8	1/4	2	\$18.78
1220L	SC DE Upcut Finisher Left Hand	3/16	5/8	1/4	2	\$23.35
1222	SC DE Upcut Finisher	8mm	25mm	8mm	64mm	\$39.53
1225*	SC DE Upcut Finisher	3/16	7/8	1/4	2 1/2	\$20.80
1228	SC DE Upcut Finisher	7/32	3/4	1/4	2 1/2	\$19.01
1230	SC DE Upcut Finisher	1/4	7/8	1/4	2 1/2	\$21.31
1230L	SC DE Upcut Finisher Left Hand	1/4	7/8	1/4	2 1/2	\$26.34
1232*	SC DE Upcut Finisher	1/4	1 1/4	1/4	3	\$24.51
1232L*	SC DE Upcut Finisher Left Hand	1/4	1 1/4	1/4	3	\$30.23
1234	SC DE Upcut Finisher	9/32	1	5/16	2 1/2	\$36.37
1235	SC DE Upcut Finisher	5/16	1 1/8	5/16	3	\$36.42
1235L	SC DE Upcut Finisher Left Hand	5/16	1 1/8	5/16	3	\$48.58
1238	SC DE Upcut Finisher	3/8	1	3/8	3	\$33.02
1240	SC DE Upcut Finisher	3/8	1 1/4	3/8	3	\$38.93
1240L	SC DE Upcut Finisher Left Hand	3/8	1 1/4	3/8	3	\$48.09
1245	SC DE Upcut Finisher	3/8	1 1/4	1/2	3 1/2	\$60.91
1245L	SC DE Upcut Finisher Left Hand	3/8	1 1/4	1/2	3 1/2	\$75.11
1246	SC DE Upcut Finisher	10mm	30mm	10mm	76mm	\$45.05
1249	SC DE Upcut Finisher	7/16	1	1/2	3	\$58.40
1249L	SC DE Upcut Finisher Left Hand	7/16	1	1/2	3	\$77.87
1250	SC DE Upcut Finisher	1/2	1 1/4	1/2	3 1/2	\$59.92
1250L	SC DE Upcut Finisher Left Hand	1/2	1 1/4	1/2	3 1/2	\$73.99
1251	SC DE Upcut Finisher	1/2	7/8	1/2	3	\$56.33
1253	SC DE Upcut Finisher	12mm	35mm	12mm	88mm	\$60.25
1255	SC DE Upcut Finisher	1/2	1 1/2	1/2	3 1/2	\$60.69
1260	SC DE Upcut Finisher	1/2	1 3/4	1/2	3 1/2	\$62.29
1265	SC DE Upcut Finisher	1/2	2 1/8	1/2	4	\$66.87
1265L	SC DE Upcut Finisher Left Hand	1/2	2 1/8	1/2	4	\$82.67
1270	SC DE Upcut Finisher	5/8	2 1/8	5/8	4	\$158.25
1270L	SC DE Upcut Finisher Left Hand	5/8	2 1/8	5/8	4	\$211.15
1275	SC DE Upcut Finisher	16mm	50mm	16mm	127mm	\$182.30
1280	SC DE Upcut Finisher	3/4	2 1/2	3/4	5	\$185.50
1282	SC DE Upcut Finisher	3/4	1 5/8	3/4	4	\$182.38
1285*	SC DE Upcut Finisher	3/4	3 1/2	3/4	6	\$316.59
1285L*	SC DE Upcut Finisher Left Hand	3/4	3 1/2	3/4	6	\$390.92
1290	SC DE Upcut Finisher	20mm	60mm	20mm	127mm	\$220.61



Three Flute Upcut Roughing Tool

Part #	Description	CED	CEL	SHK DIA	OAL	Price
1638	SC 3FLT Upcut Rougher "Castle"	3/8	1	3/8	2 1/2	\$69.25
1640	SC 3FLT Upcut Rougher	3/8	1 1/4	3/8	3	\$72.14
1650	SC 3FLT Upcut Rougher	1/2	1 1/4	1/2	3	\$81.17
1660	SC 3FLT Upcut Rougher	1/2	1 3/4	1/2	3 1/2	\$101.13
1670	SC 3FLT Upcut Rougher	5/8	2 1/8	5/8	4	\$192.15
1680	SC 3FLT Upcut Rougher	3/4	2 1/2	3/4	5	\$238.86
1680L	SC 3FLT Upcut Rougher Left Hand	3/4	2 1/2	3/4	5	\$294.96
1685*	SC 3FLT Upcut Rougher	3/4	3 1/2	3/4	6	\$361.84



Three Flute Downcut Roughing Tool

Part #	Description	CED	CEL	SHK DIA	OAL	Price
1740	SC 3FLT Downcut Rougher	3/8	1 1/4	3/8	3	\$72.14
1750	SC 3FLT Downcut Rougher	1/2	1 1/4	1/2	3	\$81.17
1750L	SC 3FLT Downcut Rougher Left Hand	1/2	1 1/4	1/2	3	\$100.29
1760	SC 3FLT Downcut Rougher	1/2	1 3/4	1/2	3 1/2	\$101.13
1770	SC 3FLT Downcut Rougher	5/8	2 1/8	5/8	4	\$192.15
1780	SC 3FLT Downcut Rougher	3/4	2 1/2	3/4	5	\$238.86
1785*	SC 3FLT Downcut Rougher	3/4	3 1/2	3/4	6	\$361.84



Two Flute Downcut Finishing Spirals

Part #	Description	CED	CEL	SHK DIA	OAL	Price
1303	3mm DE DC FINISHER	3mm	12mm	6mm	64mm	\$18.67
1305	4mm DE DC FINISHER	4mm	16mm	6mm	64mm	\$19.79
1306	SC DE Downcut Finisher	5mm	20mm	6mm	64mm	\$19.79
1308	SC DE Downcut Finisher	6mm	25mm	6mm	64mm	\$21.25
1310	SC DE Downcut Finisher	1/8	1/2	1/4	2	\$18.78
1310L	SC DE Downcut Finisher Left Hand Rotation	1/8	1/2	1/4	2	\$23.35
1312*	SC DE DC Finishing Spiral	1/8	7/8	1/4	2 1/2	\$23.50
1315	SC DE Downcut Finisher	5/32	9/16	1/4	2	\$18.78
1320	SC DE Downcut Finisher	3/16	5/8	1/4	2	\$18.78
1320L	SC DE Downcut Finisher Left Hand Rotation	3/16	5/8	1/4	2	\$23.35
1322	SC DE Downcut Finisher	8mm	25mm	8mm	64mm	\$39.53
1325*	SC DE Downcut Finisher	3/16	7/8	1/4	2 1/2	\$20.80
1328	SC DE Downcut Finisher	7/32	3/4	1/4	2 1/2	\$19.01
1330	SC DE Downcut Finisher	1/4	7/8	1/4	2 1/2	\$21.31
1330L	SC DE Downcut Finisher Left Hand Rotation	1/4	7/8	1/4	2 1/2	\$26.34
1332*	SC DE Downcut Finisher	1/4	1 1/4	1/4	3	\$24.51
1334	SC DE Downcut Finisher	9/32	1	5/16	2 1/2	\$36.37
1335	SC DE Downcut Finisher	5/16	1 1/8	5/16	3	\$36.42
1338	SC DE Downcut Finisher	3/8	1	3/8	3	\$33.02
1340	SC DE Downcut Finisher	3/8	1 1/4	3/8	3	\$38.93
1340L	SC DE Downcut Finisher Left Hand Rotation	3/8	1 1/4	3/8	3	\$48.09
1345	SC DE Downcut Finisher	3/8	1 1/4	1/2	3 1/2	\$60.91
1345L	SC DE Downcut Finisher Left Hand Rotation	3/8	1 1/4	1/2	3 1/2	\$75.11
1346	SC DE Downcut Finisher	10mm	30mm	10mm	76mm	\$45.05
1349	SC DE Downcut Finisher	7/16	1	1/2	3	\$58.40
1350	SC DE Downcut Finisher	1/2	1 1/4	1/2	3 1/2	\$59.92
1350L	SC DE Downcut Finisher Left Hand Rotation	1/2	1 1/4	1/2	3 1/2	\$73.99
1351	SC DE Downcut Finisher	1/2	7/8	1/2	3	\$56.33
1353	SC DE Downcut Finisher	12mm	35mm	12mm	88mm	\$60.25
1355	SC DE Downcut Finisher	1/2	1 1/2	1/2	3 1/2	\$60.69
1355B	SC DE Downcut Flush Trim Bearing Bit	1/2	1 1/2	1/2	4	\$102.09
1355L	SC DE Downcut Finisher Left Hand Rotation	1/2	1 1/2	1/2	3 1/2	\$75.11
1360	SC DE Downcut Finisher	1/2	1 3/4	1/2	3 1/2	\$62.29
1360L	SC DE Downcut Finisher Left Hand Rotation	1/2	1 3/4	1/2	3 1/2	\$76.95
1365	SC DE Downcut Finisher	1/2	2 1/8	1/2	4	\$66.87
1365L	SC DE Downcut Finisher Left Hand Rotation	1/2	2 1/8	1/2	4	\$82.67
1370	SC DE Downcut Finisher	5/8	2 1/8	5/8	4	\$158.25
1370L	SC DE Downcut Finisher Left Hand Rotation	5/8	2 1/8	5/8	4	\$195.35
1375	SC DE Downcut Finisher	16mm	50mm	16mm	127mm	\$182.30
1380	SC DE Downcut Finisher	3/4	2 1/2	3/4	5	\$185.50
1380L	SC DE Downcut Finisher Left Hand Rotation	3/4	2 1/2	3/4	5	\$247.33
1382	SC DE Downcut Finisher	3/4	1 5/8	3/4	4	\$182.38
1385*	SC DE Downcut Finisher	3/4	3 1/2	3/4	6	\$316.59
1390	SC DE Downcut Finisher	20mm	60mm	20mm	127mm	\$220.61



Three Flute Upcut Finishing Tool

Part #	Description	CED	CEL	SHK DIA	OAL	Price
1830	SC 3FLT Upcut Finisher	1/4	3/4	1/4	2 1/2	\$25.61
1840	SC 3FLT Upcut Finisher	3/8	1 1/4	3/8	3	\$46.72
1840L	SC 3FLT Upcut Finisher Left Hand	3/8	1 1/4	3/8	3	\$57.71
1850	SC 3FLT Upcut Finisher	1/2	1 1/4	1/2	3 1/2	\$87.84
1860	SC 3FLT Upcut Finisher	1/2	1 3/4	1/2	3 1/2	\$92.75
1860L	SC 3FLT Upcut Finisher Left Hand	1/2	1 3/4	1/2	3 1/2	\$114.51
1865	SC 3FLT Upcut Finisher	1/2	2 1/8	1/2	4	\$104.66
1870	SC 3FLT Upcut Finisher	5/8	2 1/8	5/8	4	\$174.51



Three Flute Downcut Finishing Tool

Part #	Description	CED	CEL	SHK DIA	OAL	Price
1930	SC 3FLT Downcut Finisher	1/4	3/4	1/4	2 1/2	\$25.61
1930L	SC 3FLT Downcut Finisher Left Hand	1/4	3/4	1/4	2 1/2	\$31.61
1940	SC 3FLT Downcut Finisher	3/8	1 1/4	3/8	3	\$46.72
1940L	SC 3FLT Downcut Finisher Left Hand	3/8	1 1/4	3/8	3	\$57.71
1950	SC 3FLT Downcut Finisher	1/2	1 1/4	1/2	3	\$87.84
1950L	SC 3FLT Downcut Finisher Left Hand	1/2	1 1/4	1/2	3	\$108.52
1960	SC 3FLT Downcut Finisher	1/2	1 3/4	1/2	3 1/2	\$92.75
1960L	SC 3FLT Downcut Finisher Left Hand	1/2	1 3/4	1/2	3 1/2	\$114.51
1965	SC 3FLT Downcut Finisher	1/2	2 1/8	1/2	4	\$104.66
1970	SC 3FLT Downcut Finisher	5/8	2 1/8	5/8	4	\$174.51
1970L	SC 3FLT Downcut Finisher Left Hand	5/8	2 1/8	5/8	4	\$216.07
1980	SC 3FLT Downcut Finisher	3/4	2 1/2	3/4	5	\$229.01
1980L	SC 3FLT Downcut Finisher Left Hand	3/4	2 1/2	3/4	5	\$282.83
1982	SC 3FLT Downcut Finisher	3/4	1 5/8	3/4	4	\$212.70
1985*	SC 3FLT Downcut Finisher	3/4	3 1/2	3/4	6	\$332.29
1985L*	SC 3FLT Downcut Finisher Left Hand	3/4	3 1/2	3/4	6	\$410.38



Three Flute Upcut Chipbreaker Tool

Part #	Description	CED	CEL	SHK DIA	OAL	Price
2040	SC 3FLT Upcut Chipbreaker	3/8	1 1/4	3/8	3	\$75.08
2050	SC 3FLT Upcut Chipbreaker	1/2	1 1/4	1/2	3	\$104.15
2060	SC 3FLT Upcut Chipbreaker	1/2	1 3/4	1/2	3 1/2	\$106.49
2060L	SC 3FLT Upcut Chipbreaker Left Hand	1/2	1 3/4	1/2	3 1/2	\$131.45
2065	SC 3FLT Upcut Chipbreaker	1/2	2 1/8	1/2	4	\$127.10
2070	SC 3FLT Upcut Chipbreaker	5/8	2 1/8	5/8	4	\$218.93
2070L	SC 3FLT Upcut Chipbreaker Left Hand	5/8	2 1/8	5/8	4	\$291.98
2080	SC 3FLT Upcut Chipbreaker	3/4	2 1/2	3/4	5	\$281.67



Three Flute Downcut Chipbreaker Tool

Part #	Description	CED	CEL	SHK DIA	OAL	Price
2140	SC 3FLT Downcut Chipbreaker	3/8	1 1/4	3/8	3	\$75.08
2140L	SC 3FLT Downcut Chipbreaker Left Hand	3/8	1 1/4	3/8	3	\$92.75
2150	SC 3FLT Downcut Chipbreaker	1/2	1 1/4	1/2	3 1/2	\$104.15
2160	SC 3FLT Downcut Chipbreaker	1/2	1 3/4	1/2	3 1/2	\$106.49
2165	SC 3FLT Downcut Chipbreaker	1/2	2 1/8	1/2	4	\$127.10
2170	SC 3FLT Downcut Chipbreaker	5/8	2 1/8	5/8	4	\$218.93
2180	SC 3FLT Downcut Chipbreaker	3/4	2 1/2	3/4	5	\$281.67



Two Flute Upcut Ballnose Router Bits

Part #	Description	CED	CEL	SHK DIA	OAL	Price
2203	SC DE Upcut Ballnose	3mm	12mm	6mm	64mm	\$28.14
2204	SC DE Upcut Ballnose	1/16	1/4	1/8	1 1/2	\$30.97
2208	SC DE Upcut Ballnose	6mm	22mm	6mm	64mm	\$28.49
2210	SC DE Upcut Ballnose	1/8	1/2	1/8	1 1/2	\$27.76
2222	SC DE Upcut Ballnose	8mm	25mm	8mm	64mm	\$48.90
2230	SC DE Upcut Ballnose	1/4	7/8	1/4	2 1/2	\$32.76
2230L	SC DE Upcut Ballnose Left Hand	1/4	7/8	1/4	2 1/2	\$49.43
2235*	SC DE Upcut Ballnose	1/4	1 1/2	1/4	4	\$49.93
2240	SC DE Upcut Ballnose	3/8	1 1/4	3/8	3	\$51.76
2243*	SC DE Upcut Ballnose	3/8	1 1/2	3/8	4	\$79.47
2246	SC DE Upcut Ballnose	10mm	29mm	10mm	76mm	\$51.78
2250	SC DE Upcut Ballnose	1/2	1 1/4	1/2	3	\$81.13
2250L	SC DE Upcut Ballnose Left Hand	1/2	1 1/4	1/2	3	\$107.70
2253	SC DE Upcut Ballnose	12mm	29mm	12mm	76mm	\$74.31
2255	SC DE Upcut Ballnose	1/2	1 1/2	1/2	3 1/2	\$82.03
2258	SC DE Upcut Ballnose	1/2	1 1/2	1/2	5	\$96.87
2265	SC DE Upcut Ballnose	1/2	2 1/8	1/2	4	\$86.06
2265L	SC DE Upcut Ballnose Left Hand	1/2	2 1/8	1/2	4	\$114.75
2270	SC DE Upcut Ballnose	5/8	2 1/8	5/8	4	\$197.40
2280	SC DE Upcut Ballnose	3/4	2 1/2	3/4	5	\$221.22
2280L	SC DE Upcut Ballnose Left Hand	3/4	2 1/2	3/4	5	\$294.96
2282	SC DE Upcut Ballnose	3/4	1 1/2	3/4	4	\$209.78
2285*	SC DE Upcut Ballnose	3/4	3 1/2	3/4	6	\$341.46



Pass by Spiral Upcut

Part #	Description	CED	CEL	SHK DIA	OAL	Price
2305	SC DE Upcut Pass By - DOC 1" - Finisher	1/8	1/2	1/4	3	\$80.98
2310	SC DE Upcut Pass-by - DOC 2.625" - Finisher	3/8	1	3/8	4	\$109.01
2320	SC DE Upcut Pass-by - DOC 3.50" - Finisher	1/2	1 1/4	1/2	5	\$114.28
2325	SC DE Upcut Pass-by - DOC 4.50" - Finisher	1/2	1 1/2	1/2	6	\$120.24
2340	SC DE Upcut Pass-by - DOC 4.50" - Finisher	5/8	1 1/2	5/8	6	\$336.64
2345	SC DE Upcut Pass-by - DOC 3.50" - Finisher	3/4	1 1/2	3/4	5	\$360.69
2350	SC DE Upcut Pass-by - DOC 4.50" - Finisher	3/4	1 1/2	3/4	6	\$379.93
2360	SC 3FLT Upcut Pass-by - DOC 2.625" - Finisher	3/8	1	3/8	4	\$111.76
2365	SC 3FLT Upcut Pass-by - DOC 3.50" - Finisher	1/2	1 1/4	1/2	5	\$116.79
2370	SC 3FLT Upcut Pass-by - DOC 4.50" - Finisher	1/2	1 1/2	1/2	6	\$122.71
2373R	SC 3FLT Upcut Pass-by - DOC 4.50" - Rougher	1/2	1 1/2	1/2	6	\$199.48
2375	SC 3FLT Upcut Pass-by - DOC 4.50" - Finisher	5/8	1 1/2	5/8	6	\$341.46
2377R	SC 3FLT Upcut Pass-by - DOC 4.50" - Rougher	5/8	2	5/8	6	\$348.09
2380	SC 3FLT Upcut Pass-by - DOC 3.50" - Finisher	3/4	1 1/2	3/4	5	\$365.50
2385	SC 3FLT Upcut Pass-by - DOC 4.50" - Finisher	3/4	1 1/2	3/4	6	\$384.73
2387R	SC 3FLT Upcut Pass-by - DOC 4.50" - Rougher	3/4	2	3/4	6	\$398.48



Upcut Tornado Router Bits

Part #	Description	CED	CEL	SHK DIA	OAL	Price
2442	SC 4FLT Upcut "Tornado"	3/8	1 1/4	3/8	3	\$113.82
2442L	SC 4FLT Upcut "Tornado" Left Hand	3/8	1 1/4	3/8	3	\$140.61
2450	SC 4FLT Upcut "Tornado"	1/2	1 1/4	1/2	3	\$158.66
2455	SC 4FLT Upcut "Tornado"	1/2	1 1/2	1/2	3 1/2	\$170.38
2460	SC 4FLT Upcut "Tornado"	1/2	1 3/4	1/2	3 1/2	\$175.60
2465	SC 4FLT Upcut "Tornado"	1/2	2 1/8	1/2	4	\$205.65
2480	SC 4FLT Upcut "Tornado"	3/4	2 1/2	3/4	5	\$349.65
2480L	SC 4FLT Upcut "Tornado" Left Hand	3/4	2 1/2	3/4	5	\$457.10



Downcut Tornado Router Bits

Part #	Description	CED	CEL	SHK DIA	OAL	Price
2542	SC 4FLT Downcut "Tornado"	3/8	1 1/4	3/8	3	\$113.82
2542L	SC 4FLT Downcut "Tornado" Left Hand	3/8	1 1/4	3/8	3	\$140.61
2550	SC 4FLT Downcut "Tornado"	1/2	1 1/4	1/2	3	\$158.66
2555	SC 4FLT Downcut "Tornado"	1/2	1 1/2	1/2	3 1/2	\$170.38
2560	SC 4FLT Downcut "Tornado"	1/2	1 3/4	1/2	3 1/2	\$175.60
2565	SC 4FLT Downcut "Tornado"	1/2	2 1/8	1/2	4	\$205.65
2580	SC 4FLT Downcut "Tornado"	3/4	2 1/2	3/4	5	\$349.65



Solid Carbide Spiral Dovetail Bits

Part #	Description	CED	CEL	SHK DIA	OAL	Price
2620	SC Upcut Dovetail Spiral	14mm	.354 (9mm)	14mm w/flat	60mm	\$163.23
2620L	SC Upcut Dovetail Spiral Left Hand	14mm	.354" (9mm)	14mm w/flat	60mm	\$217.65
2630	SC Upcut Dovetail Sprial	14mm	.394" DOC	14mm w/flat	60mm	\$163.23
2630L	SC Upcut Dovetail Spiral Left Hand	14mm	.394" DOC	14mm w/flat	60mm	\$217.65
2640	SC Upcut Dovetail Spiral	14mm	.622" DOC	14mm w/flat	60mm	\$168.18
2640L	SC Upcut Dovetail Spiral Left Hand	14mm	.622" DOC	14mm w/flat	60mm	\$224.34
2660	SC Downcut Dovetail Spiral	14mm	.394" DOC	14mm w/flat	60mm	\$163.23
2660L	SC Downcut Dovetail Spiral Left Hand	14mm	.394" DOC	14mm w/flat	60mm	\$217.65
2670	SC Downcut Dovetail Spiral	14mm	.622" DOC	14mm w/flat	60mm	\$168.18
2670L	SC Downcut Dovetail Spiral Left Hand	14mm	.622" DOC	14mm w/flat	60mm	\$224.34
2680	SC Upcut Dovetail Spiral	14mm	.394" (10mm)	12mm	60mm	\$185.96



Two Flute Roughing Compression

Part #	Description	CED	CEL	SHK DIA	OAL	Price
2930	SC DE Roughing Comp	3/8	1 1/8	3/8	3	\$95.73
2985 (m)	SC DE Roughing Comp	3/8	7/8	3/8	3	\$95.73
2935	SC DE Roughing Comp	1/2	1	1/2	3	\$104.79
2989 (m)	SC DE Roughing Comp	1/2	1	1/2	3	\$104.79
2952	SC DE Roughing Comp	1/2	1 3/8	1/2	3 1/2	\$122.65
2960	SC DE Roughing Comp	1/2	1 3/4	1/2	3 1/2	\$128.61
2980	SC DE Roughing Comp	3/4	2	3/4	4	\$291.98
2980L	SC DE Roughing Comp Left Hand	3/4	2	3/4	4	\$374.43



Single Flute Upcut & Downcut Spiral (compression spiral)

Part #	Description	CED	CEL	SHK DIA	OAL	Price
3010	SC SE Comp Spiral	1/4	7/8	1/4	2 1/2	\$54.28
3010L	SC SE Comp Spiral	1/4	7/8	1/4	2 1/2	\$69.62
3030	SC SE Comp Spiral	3/8	1 1/8	3/8	3	\$66.32
3030L	SC SE Comp Spiral	3/8	1 1/8	3/8	3	\$85.19
3035	SC SE Comp Spiral	1/2	1	1/2	3	\$90.46
3052	SC SE Comp Spiral	1/2	1 3/8	1/2	3 1/2	\$96.50
3052L	SC SE Comp Spiral	1/2	1 3/8	1/2	3 1/2	\$123.67
3060	SC SE Comp Spiral	1/2	1 3/4	1/2	3 1/2	\$96.50
3070	SC SE Comp Spiral	5/8	2	5/8	4	\$199.15
3080	SC SE Comp Spiral	3/4	2	3/4	4	\$271.43



Two Flute Upcut & Downcut Spiral (compression spiral)

Part #	Description	CED	CEL	SHK DIA	OAL	Price
3108	SC DE Comp Spiral	6mm	25mm	6mm	64mm	\$66.18
3110	SC DE Comp Spiral	1/4	7/8	1/4	3	\$56.49
3110L	SC DE Comp Spiral - LH	1/4	7/8	1/4	2 1/2	\$72.28
3122	SC DE Comp Spiral	8mm	28mm	8mm	64mm	\$88.12
3130	SC DE Comp Spiral	3/8	1 1/8	3/8	3	\$61.92
3130L	SC DE Comp Spiral - LH	3/8	1 1/8	3/8	3	\$79.47
3135	SC DE Comp Spiral	1/2	1	1/2	3	\$76.21
3135L	SC DE Comp Spiral - LH	1/2	1	1/2	3	\$97.79
3145	SC DE Comp Spiral	10mm	35mm	10mm	76mm	\$96.19
3152	SC DE Comp Spiral	1/2	1 3/8	1/2	3 1/2	\$80.97
3152L	SC DE Comp Spiral - LH	1/2	1 3/8	1/2	3 1/2	\$103.97
3155	SC DE Comp Spiral	12mm	35mm	12mm	88mm	\$127.78
3160	SC DE Comp Spiral	1/2	1 3/4	1/2	3 1/2	\$85.74
3160L	SC DE Comp Spiral - LH	1/2	1 3/4	1/2	3 1/2	\$109.93
3162	SC DE Comp Spiral	1/2	2	1/2	4	\$109.46
3162L	SC DE Comp Spiral - LH	1/2	2	1/2	4	\$140.39
3170	SC DE Comp Spiral	5/8	2	5/8	4	\$218.93
3170L	SC DE Comp Spiral - LH	5/8	2	5/8	4	\$280.77
3179	SC DE Comp Spiral	3/4	1 5/8	3/4	4	\$225.06
3180	SC DE Comp Spiral	3/4	2	3/4	4	\$271.43
3180L	SC DE Comp Spiral - LH	3/4	2	3/4	4	\$326.11
3183	SC DE Comp Spiral	3/4	2 1/2	3/4	5	\$292.22
3183L	SC DE Comp Spiral - LH	3/4	2 1/2	3/4	5	\$352.68



Two Flute Mortise Compression

Part #	Description	CED	CEL	SHK DIA	OAL	Price
3112*	SC DE Mortise Comp Spiral	1/4	7/8	1/4	3	\$56.49
3115*	SC DE Mortise Comp Spiral	1/4	5/8	1/4	2 1/2	\$55.66
3115L*	SC DE Mortise Comp Spiral LH	1/4	5/8	1/4	2 1/2	\$71.45
3184*	SC DE Mortise Comp Spiral	3/8	7/8	3/8	3	\$61.92
3185	SC DE Mortise Comp Spiral	3/8	7/8	3/8	3	\$61.92
3185L	SC DE Mortise Comp Spiral LH	3/8	7/8	3/8	3	\$79.47
3187*	SC DE Mortise Comp Spiral	1/2	1	1/2	3	\$76.21
3188	SC DE Mortise Comp Spiral	1/2	1 3/8	1/2	3 1/2	\$80.97
3189	SC DE Mortise Comp Spiral	1/2	1	1/2	3	\$76.21
3189L	SC DE Mortise Comp Spiral LH	1/2	1	1/2	3	\$97.79
3190	SC DE Mortise Comp Spiral	1/2	1 5/8	1/2	3 1/2	\$100.91
3190L	SC DE Mortise Comp Spiral LH	1/2	1 5/8	1/2	3 1/2	\$129.39
3168	SC DE Mortise Comp Spiral	9/16	1	1/2	3	\$115.52
3168L	SC DE Mortise Comp Spiral LH	9/16	1	1/2	3	\$148.17
3193	SC DE Mortise Comp Spiral	5/8	2	5/8	4	\$189.07
3198	SC DE Mortise Comp Spiral	3/4	1 1/2	3/4	4	\$230.01
3105 (m*)	SC DE Mortise Comp Spiral	6mm	22mm	6mm	64mm	\$66.18
3120 (m)	SC DE Mortise Comp Spiral	8mm	25mm	8mm	64mm	\$88.12
3140 (m)	SC DE Mortise Comp Spiral	10mm	30mm	10mm	76mm	\$96.19
3154 (m)	SC DE Mortise Comp Spiral	12mm	25mm	12mm	76mm	\$127.78



Three Flute Upcut & Downcut Spiral (compression spiral)

Part #	Description	CED	CEL	SHK DIA	OAL	Price
3284 (m*)	SC 3E Mortise Comp	3/8	7/8	3/8	3	\$81.30
3285 (m)	SC 3E Mortise Comp	3/8	7/8	3/8	3	\$81.30
3285L (m)	SC 3E Comp Spiral - LH	3/8	7/8	3/8	3	\$108.55
3230	SC 3E Comp Spiral	3/8	1 1/8	3/8	3	\$81.30
3235	SC 3FLT Comp Spiral	1/2	1	1/2	3	\$108.55
3235L	SC 3E Comp Spiral - LH	1/2	1	1/2	3	\$144.73
3287 (m*)	SC 3E Mortise Comp	1/2	1	1/2	3	\$108.55
3289 (m)	SC 3E Mortise Comp	1/2	1	1/2	3	\$108.55
3289L (m)	SC 3E Comp Spiral - LH	1/2	1	1/2	3	\$154.65
3252	SC 3E Comp Spiral	1/2	1 3/8	1/2	3 1/2	\$114.28
3252L	SC 3E Comp Spiral - LH	1/2	1 3/8	1/2	3 1/2	\$146.56
3290 (m)	SC 3E Mortise Comp	1/2	1 5/8	1/2	3 1/2	\$116.70
3260	SC 3E Comp Spiral	1/2	1 3/4	1/2	3 1/2	\$120.78
3270	SC 3E Comp Spiral	5/8	2	5/8	4	\$258.34
3280	SC 3E Comp Spiral	3/4	2	3/4	4	\$321.07



Three Flute Upcut & Downcut Spiral (compression spiral) with Chipbreakers

Part #	Description	CED	CEL	SHK DIA	OAL	Price
3230C	SC 3E Chipbreaker Comp	3/8	1 1/8	3/8	3	\$100.99
3235C	SC 3E Chipbreaker Comp	1/2	1	1/2	3	\$128.57
3252C	SC 3E Chipbreaker Comp	1/2	1 3/8	1/2	3 1/2	\$134.20
3280C	SC 3E Chipbreaker Comp	3/4	2	3/4	4	\$348.46
3285C (m)	SC 3E Chipbreaker Comp	3/8	7/8	3/8	3	\$100.99
3289C (m)	SC 3E Chipbreaker Comp	1/2	1	1/2	3	\$128.57



Four Flute Compression Spirals

Part #	Description	CED	CEL	SHK DIA	OAL	Price
3335	SC 4E Comp Spiral	1/2	1	1/2	3	\$132.92
3389 (m)	SC 4E Mortise Comp	1/2	1	1/2	3	\$132.92
3352	SC 4E Comp Spiral	1/2	1 3/8	1/2	3 1/2	\$150.90
3390 (m)	SC 4E Mortise Comp	1/2	1 5/8	1/2	3 1/2	\$150.60
3360	SC 4E Comp Spiral	1/2	1 3/4	1/2	3 1/2	\$157.83
3380	SC 4E Comp Spiral	3/4	2	3/4	4	\$392.75



Two Flute Upcut & Downcut Spiral (with chipbreakers)

Part #	Description	CED	CEL	SHK DIA	OAL	Price
3422	SC DE Chipbreaker Compression	8mm	27mm	8mm	64mm	\$97.28
3445	SC DE Compression w/Chipbreakers	10mm	30mm	10mm	76mm	\$107.87
3455	SC DE Compression w/Chipbreakers	12mm	35mm	12mm	88mm	\$139.24
3485 (m)	SC DE Chipbreaker Comp	3/8	7/8	3/8	3	\$84.28
3430	SC DE Chipbreaker Comp	3/8	1 1/8	3/8	3	\$84.28
3435	SC DE Chipbreaker Comp	1/2	1	1/2	3	\$96.74
3489 (m)	SC DE Chipbreaker Comp	1/2	1	1/2	3	\$96.74
3452	SC DE Chipbreaker Comp	1/2	1 3/8	1/2	3 1/2	\$106.26
3460	SC DE Chipbreaker Comp	1/2	1 3/4	1/2	3 1/2	\$113.13
3470	SC DE Chipbreaker Comp	5/8	2	5/8	4	\$241.15
3480	SC DE Chipbreaker Comp	3/4	2	3/4	4	\$298.63
3480L	SC DE Compression w/Chipbreakers LH Rotation	3/4	2	3/4	4	\$382.90
3483	SC DE Chipbreaker Comp	3/4	2 1/2	3/4	5	\$304.58
3483L	SC DE Compression w/Chipbreakers LH Rotation	3/4	2 1/2	3/4	5	\$390.69



Tornado Compression Router Bits

Part #	Description	CED	CEL	SHK DIA	OAL	Price
3535	SC 4E "Tornado" Comp	1/2	1	1/2	3	\$149.32
3589 (m)	SC 4E "Tornado" Comp	1/2	1	1/2	3	\$149.32
3552	SC 4E "Tornado" Comp	1/2	1 3/8	1/2	3 1/2	\$165.25
3552L	SC 4E "Tornado" Comp	1/2	1 3/8	1/2	3 1/2	\$220.54
3560	SC 4E "Tornado" Comp	1/2	1 3/4	1/2	3 1/2	\$174.27
3570	SC 4E "Tornado" Comp	5/8	2	5/8	4	\$201.39
3580	SC 4E "Tornado" Comp	3/4	2	3/4	4	\$291.98
3580L	4E Tornado Compression Spiral - Left Hand Rotation	3/4	2	3/4	4	\$374.43
3583	SC 4E "Tornado" Comp	3/4	2 1/2	3/4	5	\$359.86



Double Eased Edge Radius Spirals

Part #	Description	CED	CEL	SHK DIA	OAL	Price
3640	SC DE Upcut Eased Edge - Radius = 1/8, Opening = .531, Material Thickness =	3/4	1	3/4	4	\$224.66
3650	SC DE Upcut Eased Edge - Radius = 1/8, Opening = .656, Material Thickness =	3/4	1 1/8	3/4	4	\$228.10
3660	SC DE Upcut Eased Edge - Radius = 1/8, Opening = .781, Material Thickness =	3/4	1 1/4	3/4	4	\$231.99
3670	SC DE Upcut Eased Edge - Radius = 1/8, Opening = 1.045, Material Thickness = 1	3/4	1 1/2	3/4	4	\$240.00
3680	SC DE Upcut Eased Edge - Radius = 1/8, Opening = 1.297, Material Thickness = 1 1/8	3/4	1 5/8	3/4	4	\$249.26



Solid Carbide Veining Bits

Part #	Description	SM DIA	RADIUS	SHK DIA	OAL	Price
3710	SC Veining Bits - SM DIA = .094, Radius = .125	0.094	.125"R	1/4	2	\$25.65
3720	SC Veining Bits - SM DIA = .094, Radius = .187	0.094	.187" R	1/4	2	\$25.65
3730	SC Veining Bits - SM DIA = .125, Radius = .250	0.125	.250"R	3/8	3	\$36.18



Solid Carbide Beading Bits

Part #	Description	SM DIA	RADIUS	SHK DIA	OAL	Price
3750	.125" Radius SC Beading Bit	.110"	.125"R	1/2	3	\$123.67
3760	.187"R DE SC Beading Bit	.110"	.187" R	1/2	3	\$123.67
3770	.250" Radius DE SC Beading Bit	.110"	.250"R	1/2"	3"	\$130.54



Solid Carbide VPoint Bits

Part #	Description	CED	CEL	SHK DIA	OAL	Price
3830	SC 60° V-Point Bits	1/4	1/2	1/4	3	\$34.35
3835	SC 90° V-Point Bits	1/4	1/2	1/4	3	\$32.38
3840	SC 60° V-Point Bits	3/8	5/8	3/8	3	\$57.94
3845	SC 90° V-Point Bits	3/8	5/8	3/8	3	\$56.11
3850	SC 60° V-Point Bits	1/2	5/8	1/2	3	\$75.81
3855	SC 90° V-Point Bits	1/2	5/8	1/2	3	\$74.20
3860	60* SC V-Point Bit	6mm	12mm	6mm	64mm	\$43.51
3865	90* SC V-Point Bit	6mm	12mm	6mm	64mm	\$42.13
3870	60* V-Point Bit	12mm	16mm	12mm	76mm	\$92.52
3875	90* V-Point Bit	12mm	16mm	12mm	76mm	\$90.23
3880	90* V-Point with .090" Flat for Alucobond, Dibond, etc	1/2	13/64	1/2	3	\$80.50



Solid Carbide Compression Door Bit

Part #	Description	CED	CEL	SHK DIA	OAL	Price
3950	SC DE Compression Door Bit	1/2	2 1/2	1/2	5 1/2	\$164.89



Double Edge Straight Flute

Part #	Description	CED	CEL	SHK DIA	OAL	Price
4005	SC DE Straight Flute	4mm	16mm	6mm	64mm	\$29.26
4006	SC DE Straight Flute	5mm	20mm	6mm	64mm	\$29.26
4008	SC DE Straight Flute	6mm	25mm	6mm	64mm	\$31.19
4010	SC DE Straight Flute	1/8	1/2	1/4	2	\$20.61
4020	SC DE Straight Flute	3/16	3/4	1/4	2	\$21.84
4020L	SC DE Straight Flute	3/16	3/4	1/4	2	\$27.02
4022	SC DE Straight Flute	8mm	25mm	8mm	76mm	\$35.23
4030	SC DE Straight Flute	1/4	7/8	1/4	2 1/2	\$23.14
4033	SC DE Straight Flute	1/4	1 1/8	1/4	3	\$24.74
4033L	SC DE Straight Flute	1/4	1 1/8	1/4	3	\$30.68
4037	SC DE Straight Flute	3/8	1	3/8	3	\$43.33
4040	SC DE Straight Flute	3/8	1 1/4	3/8	3	\$44.51
4040L	SC DE Straight Flute	3/8	1 1/4	3/8	3	\$54.96
4046	SC DE Straight Flute	10mm	35mm	10mm	76mm	\$73.92
4047	SC DE Straight Flute	1/2	1	1/2	3	\$65.82
4050	SC DE Straight Flute	1/2	1 1/4	1/2	3	\$68.25
4053	SC DE Straight Flute	12mm	35mm	12mm	88mm	\$80.27
4070	SC DE Straight Flute	5/8	2 1/8	5/8	4	\$145.42
4080	SC DE Straight Flute	3/4	2 1/8	3/4	4	s



High Helix Foam Bits

Part #	Description	CED	CEL	SHK DIA	OAL	Price
4135*	SC DE Upcut Foam Sprls	1/4	2	1/4	4	\$62.29
4140	SC DE Upcut Foam Sprls	3/8	1 1/2	3/8	3	\$64.08
4160	SC DE Upcut Foam Sprls	1/2	1 3/4	1/2	3 1/2	\$95.05
4165	SC DE Upcut Foam Sprls	1/2	2 1/4	1/2	4	\$124.58
4185	SC DE Upcut Foam Sprls	3/4	3 1/4	3/4	6	\$327.03



Two Flute Low Helix Upcut Finishers

Part #	Description	CED	CEL	SHK DIA	OAL	Price
4208	SC DE UC Low Helix	6mm	20mm	6mm	64mm	\$21.25
4220	SC DE UC Low Helix	3/16	5/8	1/4	2 1/2	\$23.78
4220L	SC DE Upcut Lw Helix LH Rotation	3/16	5/8	1/4	2 1/2	\$32.52
4230	SC DE Upcut Low Helix	1/4	3/8	1/4	3	\$19.24
4230L	SC DE Upcut Low Helix	1/4	3/8	1/4	3	\$25.65
4233	SC DE Upcut Low Helix	1/4	3/4	1/4	3	\$21.52
4235	DE UC Low Helix Finisher	5/16	1	5/16	3	\$36.60
4240	SC DE Upcut Low Helix	3/8	1	3/8	3	\$36.60
4245	SC DE Upcut Low Helix	1/2	1	1/2	3	\$61.90
4246	SC DE UC Low Helix	10mm	30mm	10mm	76mm	\$45.05
4250	SC DE Upcut Low Helix	1/2	1 1/4	1/2	3 1/2	\$63.96
4253	SC DE UC Low Helix	12mm	35mm	12mm	88mm	\$60.25
4260	SC DE Upcut Low Helix	1/2	1 3/4	1/2	4	\$74.10
4260L	SC DE Upcut Lw Helix LH Rotation	1/2	1 3/4	1/2	3 1/2	\$98.29
4280	SC DE Upcut Low Helix	3/4	2 1/2	3/4	5	\$204.28



Two Flute Low Helix Downcut Finishers

Part #	Description	CED	CEL	SHK DIA	OAL	Price
4308	DE DC Low Helix Finisher	6mm	20mm	6mm	64mm	\$21.25
4320	DE DC Low Helix Finisher	3/16	5/8	1/4	2 1/2	\$23.78
4330	SC DE Downcut Low Helix	1/4	3/8	1/4	3	\$19.24
4333	SC DE Downcut Low Helix	1/4	3/4	1/4	3	\$21.52
4335	DE DC Low Helix Finisher	5/16	1	5/16	3	\$36.60
4340	SC DE Downcut Low Helix	3/8	1	3/8	3	\$36.60
4345	SC DE Downcut Low Helix	1/2	1	1/2	3 1/2	\$61.90
4346	DE DC Low Helix Finisher	10mm	30mm	10mm	76mm	\$45.05
4350	SC DE Downcut Low Helix	1/2	1 1/4	1/2	3 1/2	\$63.96
4350L	SC DE Downcut Low Helix	1/2	1 1/4	1/2	3 1/2	\$78.61
4353	DE DC Low Helix Finisher	12mm	35mm	12mm	88mm	\$64.30
4360	SC DE Downcut Low Helix	1/2	1 3/4	1/2	4	\$74.10
4380	SC DE Downcut Low Helix	3/4	2 1/2	3/4	6	\$204.28



Three Flute Low Helix Upcut Finishers

Part #	Description	CED	CEL	SHK DIA	OAL	Price
4430	SC 3E Upcut Low Helix	1/4	3/8	1/4	3	\$36.18
4433	SC 3E Upcut Low Helix	1/4	3/4	1/4	3	\$38.01
4435	3E UC Low Helix Finisher	5/16	1	5/16	3	\$56.11
4438	3E Low Helix Upcut Fnisher	3/8	5/8	3/8	3	\$65.04
4440	SC 3E Upcut Low Helix	3/8	1	3/8	3	\$66.41
4445	SC 3E Upcut Low Helix	1/2	1	1/2	3	\$75.11
4450	SC 3E Upcut Low Helix	1/2	1 1/4	1/2	3 1/2	\$84.28
4460	SC 3E Upcut Low Helix	1/2	1 3/4	1/2	4	\$95.73
4460L	SC 3E Upcut Low Helix	1/2	1 3/4	1/2	4	\$118.17
4480	SC 3E Upcut Low Helix	3/4	2 1/2	3/4	5	\$206.80



Three Flute Low Helix Downcut Finishers

Part #	Description	CED	CEL	SHK DIA	OAL	Price
4530	SC 3E Downcut Low Helix	1/4	3/8	1/4	3	\$36.18
4533	SC 3E Downcut Low Helix	1/4	3/4	1/4	3	\$38.01
4535	3E DC Low Helix Finisher	5/16	1	5/16	3	\$56.11
4538	3E Low Helix Downcut Fnisher	3/8	5/8	3/8	3	\$65.04
4540	SC 3E Downcut Low Helix	3/8	1	3/8	3	\$66.41
4545	SC 3E Downcut Low Helix	1/2	1	1/2	3 1/2	\$75.11
4550	SC 3E Downcut Low Helix	1/2	1 1/4	1/2	3 1/2	\$84.28
4560	SC 3E Downcut Low Helix	1/2	1 3/4	1/2	4	\$101.41
4560L	SC 3E Downcut Low Helix	1/2	1 3/4	1/2	4	\$125.27
4580	SC 3E Downcut Low Helix	3/4	2 1/2	3/4	6	\$228.55



Low Helix Single Edge Finishing Spiral

Part #	Description	CED	CEL	SHK DIA	OAL	Price
4630	SC SE Upcut Low Helix	1/4	3/8	1/4	3	\$20.84
4633	SC SE Upcut Low Helix	1/4	3/4	1/4	3	\$22.91
4640	SC SE Upcut Low Helix	3/8	1	3/8	3	\$38.93
4730	SC SE Downcut Low Helix	1/4	3/8	1/4	3	\$20.84
4733	SC SE Downcut Low Helix	1/4	3/4	1/4	3	\$22.91
4740	SC SE Downcut Low Helix	3/8	1	3/8	3	\$38.93



Two Flute "Low Helix" Roughing Tools (upcut & downcut)

Part #	Description	CED	CEL	SHK DIA	OAL	Price
5050	SC DE Upcut Rougher	1/2	1 1/4	1/2	3 1/2	\$87.48
5060	SC DE Upcut Rougher	1/2	1 3/4	1/2	3 1/2	\$95.96
5080	SC DE Upcut Rougher	3/4	2 1/2	3/4	5	\$228.55
5150	SC DE Downcut Rougher	1/2	1 1/4	1/2	3 1/2	\$87.48
5160	SC DE Downcut Rougher	1/2	1 3/4	1/2	4	\$102.37
5180	SC DE Downcut Rougher	3/4	2 1/2	3/4	6	\$238.17



Three Flute "Low Helix" Roughing Tools (upcut and downcut)

Part #	Description	CED	CEL	SHK DIA	OAL	Price
5240	SC 3FLT Upcut Rougher	3/8	1	3/8	3	\$107.63
5250	SC 3FLT Upcut Rougher	1/2	1 1/4	1/2	3 1/2	\$126.41
5250L	SC 3FLT Upcut Rougher Left Hand	1/2	1 1/4	1/2	3 1/2	\$168.55
5260	SC 3FLT Upcut Rougher	1/2	1 3/4	1/2	3 1/2	\$136.26
5280	SC 3FLT Upcut Rougher	3/4	2 1/2	3/4	5	\$267.48
5340	SC 3FLT Downcut Rougher	3/8	1	3/8	3	\$107.63
5350	SC 3FLT Downcut Rougher	1/2	1 1/4	1/2	3 1/2	\$126.41
5360	SC 3FLT Downcut Rougher	1/2	1 3/4	1/2	4	\$136.26
5380	SC 3FLT Downcut Rougher	3/4	2 1/2	3/4	6	\$279.39



Single Edge "O" Flute Straight

Part #	Description	CED	CEL	SHK DIA	OAL	Price
5404	SC SE O'Flute Straight	1/16	1/4	1/8	1 1/2	\$27.71
5409	SC SE O'Flute Straight	1/8	1/4	1/4	2	\$22.91
5410	SC SE O'Flute Straight	1/8	1/2	1/4	2	\$24.28
5410L	SC SE O'Flute Straight LH	1/8	1/2	1/4	2	\$26.80
5412	SC SE O'Flute Straight	1/8	5/8	1/4	4	\$32.06
5412L	SC SE O'Flute Straight LH	1/8	5/8	1/4	4	\$47.66
5415	SC SE O'Flute Straight	5/32	5/8	1/4	2	\$25.19
5415L	SC SE O'Flute Straight - LH Rotation	5/32	5/8	1/4	2	\$28.85
5418	SC SE O'Flute Straight	3/16	3/8	1/4	2	\$22.68
5420	SC SE O'Flute Straight	3/16	5/8	1/4	2	\$22.68
5420L	SC SE O'Flute Straight LH	3/16	5/8	1/4	2	\$26.11
5422*	SC SE O'Flute Straight	3/16	1	1/4	4	\$32.06
5422L*	SC SE O'Flute Straight	3/16	1	1/4	4	\$34.81
5430	SC SE O'Flute Straight	1/4	3/8	1/4	2 1/2	\$24.51
5433	SC SE O'Flute Straight	1/4	3/4	1/4	2 1/2	\$25.52
5433L	SC SE O'Flute Straight	1/4	3/4	1/4	2 1/2	\$27.48
5434	SC SE O'Flute Straight	1/4	1	1/4	2 1/2	\$27.26
5435	SC SE O'Flute Straight	1/4	3/4	1/4	3 1/4	\$28.40
5437	SC SE O'Flute Straight	1/4	1 1/4	1/4	3 1/4	\$30.18
5440	SC SE O'Flute Straight	1/4	1	1/4	4	\$32.52
5443	SC SE O'Flute Straight	3/8	1 1/4	3/8	3	\$43.97
5453	SC SE O'Flute Straight	1/2	1 1/4	1/2	3	\$63.66
5453L	SC SE O'Flute Straight LH	1/2	1 1/4	1/2	3	\$67.33
5454	SC SE O'Flute Straight	1/2	1 3/4	1/2	4	\$72.82
5454L	SC SE O'Flute Straight LH	1/2	1 3/4	1/2	4	\$76.04
5460	SC SE O'Flute Straight	3mm	8mm	6mm	64mm	\$26.80
5470	SC SE O'Flute Straight	4mm	16mm	6mm	64mm	\$26.11
5470L	SC SE O'Flute Straight LH	4mm	16mm	6mm	64mm	\$29.09
5475	SC SE O'Flute Straight	5mm	20mm	6mm	64mm	\$26.11
5475L	SC SE O'Flute Straight LH	5mm	20mm	6mm	64mm	\$29.09
5480	SC SE O'Flute Straight	6mm	25mm	6mm	64mm	\$26.11
5480L	SC SE O'Flute Straight LH	6mm	25mm	6mm	64mm	\$29.09
5485	SC SE O'Flute Straight	8mm	25mm	8mm	64mm	\$36.60
5490	SE O'Flute Straight	10mm	30mm	10mm	76mm	\$47.63



Double Edge "O" Flute Straight

Part #	Description	CED	CEL	SHK DIA	OAL	Price
5509	SC DE O'Flute Straight	1/8	1/4	1/4	2	\$21.98
5510	SC DE O'Flute Straight	1/8	1/2	1/4	2	\$21.98
5510L	SC DE O'Flute Straight LH	1/8	1/2	1/4	2	\$24.28
5512*	SC DE O'Flute Straight	1/8	5/8	1/4	4	\$30.00
5518	SC DE O'Flute Straight	3/16	3/8	1/4	2	\$21.07
5520	SC DE O'Flute Straight	3/16	5/8	1/4	2	\$21.07
5522*	SC DE O'Flute Straight	3/16	1	1/4	4	\$30.00
5530	SC DE O'Flute Straight	1/4	3/8	1/4	2 1/2	\$21.07
5533	SC DE O'Flute Straight	1/4	3/4	1/4	2 1/2	\$22.76
5533L	SC DE O'Flute Straight LH	1/4	3/4	1/4	2 1/2	\$24.74
5534	SC DE O'Flute Straight	1/4	1	1/4	2 1/2	\$23.14
5534L	SC DE O'Flute Straight LH	1/4	1	1/4	2 1/2	\$25.43
5535	SC DE O'Flute Straight	1/4	3/4	1/4	3 1/4	\$25.52
5537	SC DE O'Flute Straight	1/4	1 1/4	1/4	3 1/4	\$26.47
5537L	SC DE O'Flute Straight LH	1/4	1 1/4	1/4	3 1/4	\$29.78
5540	SC DE O'Flute Straight	1/4	1	1/4	4	\$42.13
5540L	SC DE O'Flute Straight - LH Rotation	1/4	1	1/4	4	\$52.22
5543	SC DE O'Flute Straight	3/8	1 1/4	3/8	3	\$59.08
5543L	SC DE O'Flute Straight LH	3/8	1 1/4	3/8	3	\$78.90
5553	SC DE O'Flute Straight	1/2	1 1/4	1/2	3	\$66.41
5554	SC DE O'Flute Straight	1/2	1 3/4	1/2	4	\$81.98
5554L	SC DE O'Flute Straight LH	1/2	1 3/4	1/2	4	\$85.19
5570	SC DE O'Flute Straight	4mm	16mm	6mm	64mm	\$24.51
5575	SC DE O'Flute Straight	5mm	20mm	6mm	64mm	\$24.51
5580	SC DE O'Flute Straight	6mm	25mm	6mm	64mm	\$24.51
5585	SC DE O'Flute Straight	8mm	25mm	8mm	64mm	\$37.10
5590	DE O'Flute Straight	10mm	30mm	10mm	76mm	\$43.06



Single Edge "O" Flute Upcut

Part #	Description	CED	CEL	SHK DIA	OAL	Price
5609	SC SE O'Flute Upcut	1/8	1/4	1/4	2	\$23.14
5610	SC SE O'Flute Upcut	1/8	1/2	1/4	2	\$23.14
5610L	SC SE O'Flute Upcut	1/8	1/2	1/4	2	\$26.34
5618	SC SE O'Flute Upcut	3/16	3/8	1/4	2	\$23.14
5620	SC SE O'Flute Upcut	3/16	5/8	1/4	2	\$23.14
5621	SC SE O'Flute Upcut	7/32	3/4	1/4	2	\$22.45
5625H	SC SE O'Flute Upcut	1/4	3/8	1/4	2 1/2	\$23.14
5630H	SC SE O'Flute Upcut	1/4	3/4	1/4	2 1/2	\$23.14
5630S	SC SE O'Flute Upcut	1/4	3/4	1/4	2 1/2	\$23.14
5632H	SC SE O'Flute Upcut	1/4	1 1/4	1/4	3 1/4	\$27.26
5632HL	SC SE O'Flute Upcut	1/4	1 1/4	1/4	3 1/4	\$31.61
5632S	SC SE O'Flute Upcut	1/4	1 1/4	1/4	3 1/4	\$27.26
5640	SC SE O'Flute Upcut	3/8	1 1/4	3/8	3	\$39.85
5650	SC SE O'Flute Upcut	1/2	1 1/4	1/2	3	\$65.73
5655	SC SE O'Flute Upcut	2mm	8mm	6mm	64mm	\$22.37
5660	SC SE O'Flute Upcut	3mm	8mm	6mm	64mm	\$22.85
5663	SC SE O'Flute Upcut	3mm	12mm	6mm	64mm	\$22.85
5668	SC SE O'Flute Upcut	4mm	8mm	6mm	64mm	\$21.52
5670	SC SE O'Flute Upcut	4mm	16mm	6mm	64mm	\$22.91
5672	SC SE O'Flute Upcut	5mm	8mm	6mm	64mm	\$21.52
5675	SC SE O'Flute Upcut	5mm	16mm	6mm	64mm	\$21.52
5677	SC SE O'Flute Upcut	6mm	10mm	6mm	64mm	\$22.91
5678	SC SE O'Flute Upcut	6mm	16mm	6mm	64mm	\$22.91
5680	SC SE O'Flute Upcut	6mm	25mm	6mm	64mm	\$22.91
5685	SC SE O'Flute Upcut	8mm	25mm	8mm	64mm	\$33.21
5690	SC SE O'Flute Upcut	10mm	30mm	10mm	76mm	\$42.13



Single Edge "O" Flute Downcut

Part #	Description	CED	CEL	SHK DIA	OAL	Price
5709	SC SE O'Flute Downcut	1/8	1/4	1/4	2	\$23.14
5710	SC SE O'Flute Downcut	1/8	1/2	1/4	2	\$23.14
5710L	SC SE "O" Flute Downcut - Left Hand Rotation	1/8	1/2	1/4	2	\$26.34
5718	SC SE O'Flute Downcut	3/16	3/8	1/4	2	\$23.14
5720	SC SE O'Flute Downcut	3/16	5/8	1/4	2	\$23.14
5721	SC SE O'Flute Downcut	7/32	3/4	1/4	2 1/2	\$22.68
5725H	SC SE O'Flute Downcut	1/4	3/8	1/4	2 1/2	\$23.14
5730H	SC SE O'Flute Downcut	1/4	3/4	1/4	2 1/2	\$23.14
5730S	SC SE O'Flute Downcut	1/4	3/4	1/4	2 1/2	\$23.14
5732H	SC SE O'Flute Downcut	1/4	1 1/4	1/4	3 1/4	\$27.26
5732S	SC SE O'Flute Downcut	1/4	1 1/4	1/4	3 1/4	\$27.26
5740	SC SE O'Flute Downcut	3/8	1 1/4	3/8	3	\$39.85
5750	SC SE O'Flute Downcut	1/2	1 1/4	1/2	3	\$65.73
5760	SC SE O'Flute Downcut	3mm	8mm	6mm	64mm	\$22.85
5763	SC SE O'Flute Downcut	3mm	12mm	6mm	64mm	\$22.85
5768	SC SE O'Flute Downcut	4mm	8mm	6mm	64mm	\$21.52
5770	SC SE O'Flute Downcut	4mm	16mm	6mm	64mm	\$22.91
5772	SC SE O'Flute Downcut	5mm	8mm	6mm	64mm	\$21.52
5775	SC SE O'Flute Downcut	5mm	16mm	6mm	64mm	\$21.52
5777	SC SE O'Flute Downcut	6mm	10mm	6mm	64mm	\$22.91
5778	SC SE O'Flute Downcut	16mm	6mm	64mm	64mm	\$22.91
5780	SC SE O'Flute Downcut	6mm	25mm	6mm	64mm	\$22.91
5785	SC SE O'Flute Downcut	8mm	25mm	8mm	64mm	\$33.21
5790	SC SE O'Flute Downcut	10mm	30mm	10mm	76mm	\$42.13



Double Edge "O" Flute Upcut

Part #	Description	CED	CEL	SHK DIA	OAL	Price
5830	SC DE O'Flute Upcut	1/4	3/8	1/4	2 1/2	\$19.79
5833	SC DE O'Flute Upcut	1/4	3/4	1/4	2 1/2	\$21.07
5835	SC DE O'Flute Upcut	5/16	1/2	3/8	3	\$37.55
5840	SC DE O'Flute Upcut	3/8	3/4	3/8	3	\$39.85
5843	SC DE O'Flute Upcut	3/8	1 1/4	3/8	3	\$40.76
5853	SC DE O'Flute Upcut	1/2	1 1/4	1/2	3 1/2	\$68.71
5880	SC DE O'Flute Upcut	6mm	25mm	6mm	64mm	\$19.93
5885	SC DE O'Flute Upcut	8mm	25mm	8mm	64mm	\$38.93



Double Edge "O" Flute Downcut

Part #	Description	CED	CEL	SHK DIA	OAL	Price
5930	SC DE O'Flute Downcut	1/4	3/8	1/4	2 1/2	\$19.79
5933	SC DE O'Flute Downcut	1/4	3/4	1/4	2 1/2	\$21.07
5933L	SC DE O'Flute Downcut	1/4	3/4	1/4	2 1/2	\$24.28
5940	SC DE O'flute Downcut	3/8	3/4	3/8	3	\$39.85
5943	SC DE O'Flute Downcut	3/8	1 1/4	3/8	3	\$40.76
5953	SC DE O'Flute Downcut	1/2	1 1/4	1/2	3	\$68.71
5980	SC DE O'Flute Downcut	6mm	25mm	6mm	64mm	\$19.93
5985	SC DE O'Flute Downcut	8mm	25mm	8mm	64mm	\$38.93



Single Edge "O" Flute Straight Edge Rounding

Part #	Description	CED	CEL	SHK DIA	OAL	Price
6010	SE O'Flute Edge Rounding - Opening: 5/32, Radius: 1/8, Plastic Size: 1/8	1/4	3/8	1/4	2 1/2	\$39.16
6015	SE O'Flute Edge Rounding - Opening: 7/32, Radius: 3/16, Plastic Size: 3/16	1/4	3/8	1/4	2 1/2	\$39.16
6020	SE O'Flute Edge Rounding - Opening: 9/32, Radius: 1/4, Plastic Size: 1/4	1/4	3/8	1/4	2 1/2	\$39.16
6030	SC DE UC Edge Rounding - Opening: 5/32, Radius: 1/8, Plastic Size: 1/8	3/8	3/8	3/8	2 1/2	\$63.12
6035	SC DE UC Edge Rounding - Opening: 7/32, Radius: 3/16, Plastic Size: 3/16	3/8	3/8	3/8	2 1/2	\$63.12
6040	SC DE UC Edge Rounding - Opening: 9/32, Radius: 1/4, Plastic Size: 1/4	3/8	3/8	3/8	2 1/2	\$63.12
6045	SC DE UC Edge Rounding - Opening: 13/32, Radius: 3/8, Plastic Size: 3/8	1/2	1/2	1/2	3	\$77.64
6050	SC DE DC Edge Rounding - Opening: 5/32, Radius: 1/8, Plastic Size: 1/8	3/8	3/8	3/8	2 1/2	\$63.12
6055	SC DE DC Edge Rounding - Opening: 7/32, Radius: 3/16, Plastic Size: 3/16	3/8	3/8	3/8	2 1/2	\$63.12
6060	SC DE DC Edge Rounding - Opening: 9/32, Radius: 1/4, Plastic Size: 1/4	3/8	3/8	3/8	2 1/2	\$63.12
6065	SC DE DC Edge Rounding - Opening: 13/32, Radius: 3/8, Plastic Size: 3/8	1/2	1/2	1/2	3	\$77.64



Three Flute Upcut Phenolic/Composite Spirals

Part #	Description	CED	CEL	SHK DIA	OAL	Price
6140	SC 3E UC Phenolic	3/8	7/8	3/8	3	\$70.54
6150	SC 3E UC Phenolic	1/2	7/8	1/2	3	\$91.14
6155	SC 3E UC Phenolic	1/2	1 1/4	1/2	3 1/2	\$93.43
6165	SC 3E UC Phenolic	1/2	2 1/8	1/2	4	\$105.34



Three Flute Downcut Phenolic/Composite Spirals

Part #	Description	CED	CEL	SHK DIA	OAL	Price
6240	SC 3E DC Phenolic	3/8	7/8	3/8	3	\$70.54
6250	SC 3E DC Phenolic	1/2	7/8	1/2	3	\$91.14
6255	SC 3E DC Phenolic	1/2	1 1/4	1/2	3 1/2	\$93.43
6265	SC 3E DC Phenolic	1/2	2 1/8	1/2	4	\$105.34



Medium Burr with Plunge Point No Flutes

Part #	Description	CED	CEL	SHK DIA	OAL	Price
6330	SC Med Burr Plunge	1/4	3/4	1/4	2 1/2	\$26.57
6340	SC Med Burr Plunge	3/8	7/8	3/8	2 1/2	\$59.31
6350	SC Med Burr Plunge	1/2	1	1/2	3	\$79.01



Two Flute Burr With Plunge Point

Part #	Description	CED	CEL	SHK DIA	OAL	Price
6430	SC DE Burr Plunge	1/4	3/4	1/4	2 1/2	\$32.94
6440	SC DE Burr Plunge	3/8	7/8	3/8	2 1/2	\$65.95
6450	SC DE Burr Plunge	1/2	1	1/2	3	\$84.96



Two Flute Compression Burr

Part #	Description	CED	CEL	SHK DIA	OAL	Price
6530	SC DE Burr Compression	1/4	3/4	1/4	2 1/2	\$73.51
6540	SC DE Burr Compression	3/8	1	3/8	3	\$100.30
6550	SC DE Burr Compression	1/2	1	1/2	3	\$141.76



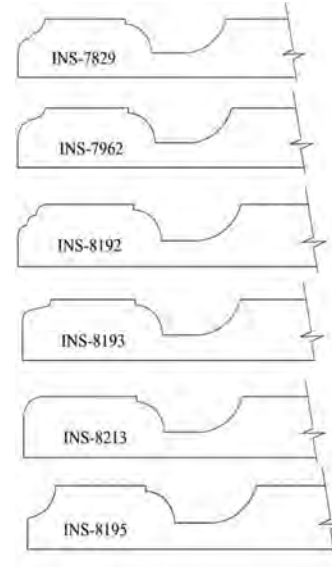

MDF Door Cutters - Outside Door Edges

Part #	Description	SHK DIA	Price
7962	Outside Door Edge Insert Tool	3/4	\$359.88
INS-7829	Outside Door Edge Repl Inserts		\$28.28
INS-7962	Outside Door Edge Repl Insert		\$28.28
INS-8192	Outside Door Edge Repl Insert		\$28.28
INS-8193	Outside Door Edge Repl Insert		\$28.28
INS-8195	Outside Door Edge Repl Insert		\$28.28

MDF Door Cutters - Inside Profiles Roughing

Part #	Description	SHK DIA	Price
7960	Inside Bevel Profile Insert Tool	3/4	\$368.92
7964	Inside Bead Insert Tool	3/4	\$359.88
INS-7960	Replacement Insert for 7960		\$32.22
INS-7964	Lrg Bead Replacement Insert for 7964		\$28.28
INS-9358	Sm Bead Replacement Insert for 7964		\$28.28



MDF Door Cutters - Inside Profiles Cleaning

Part #	Description	SHK DIA	Price
7961	Inside Bevel Cnr Clnr Insert Tool	3/4	\$332.13
7965	Ins Bead Crn Clnr Insert Body	3/4	\$332.13
INS-7961	Replacement Insert for 7961		\$30.00
INS-7965	Lrg Bead Repl Insert for 7965		\$30.00
INS-9357	Sm Bead Repl Insert for 7965		\$30.00



MDF Door Cutters - Raised Panel

Part #	Description	SHK DIA	Price
7963	MDF Panel Raise Insert Tool	3/4	\$359.88
7966	MDF Panel Raise Insert Tool	3/4	\$408.23
8215	MDF Panel Raise Insert Body	3/4	\$408.23
INS-7963	Replacement Insert for 7963		\$28.28
INS-7966	Replacement Insert for 7966		\$36.64
INS-8215	Panel Raise Insert for 8215 Body used with 3/8" Bead Insert		\$36.64



Vortex Tool - Insert Router Bits

One Pass MDF Door Cutters

Part #	Description	Price
INS-7964	Lrg Bead Replacement Insert for 7964	\$28.28
INS-8209	One Pass MDF Door Insert	\$28.28
INS-8210	One Pass MDF Door Insert	\$28.28



Part #	Description	SHK DIA	Price
7900	Four Piece Insert MDF Door Set	3/4	\$1,366.37

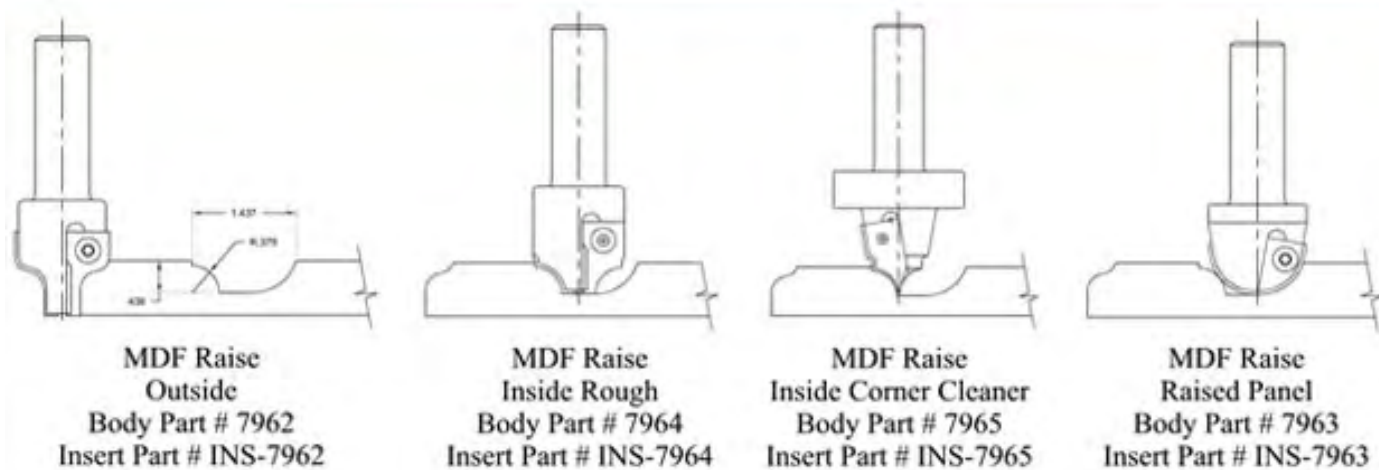

Insert V-Groove Cutters

Part #	Description	CED	Depth of Cut	SHK DIA	OAL	Price
7050	90° Insert V-Groove Cutters - Angle: 45°, Insert#: IVB-30	1 1/2	.730	1/2	3.30	\$210.42
7055	90° Insert V-Groove Cutters - Angle: 45°, Insert#: IVB-40	2 1/4	1	1/2	3.50	\$220.14
7060	90° Insert V-Groove Cutters - Angle: 45°, Insert#: IVB-40	2 1/4	1	3/4	3.75	\$223.37
7065	90° Insert V-Groove Cutters - Angle: 45°, Insert#: IVB-50	3	1 1/4	3/4	4.00	\$229.85
7075	22.5° Insert V-Groove Cutter- Included Angle-45°, Insert-IVB-10	2	5/8	1/2	3.90	\$210.42
7080	22.5° Insert V-Groove Cutter- Included Angle-45°, Insert-IVB-20	2	1	1/2	3.90	\$226.60
7085	30° Insert V-Groove Cutter- Included Angle: 60°, Insert-IVB-20	2	.966	1/2	3.90	\$226.60
7090	60° Insert V-Groove Cutter- Included Angle 120° Insert-IVB-50	3.437	.911	3/4	3.90	\$255.25



Insert Spoilboard Cutters

Part #	Description	CED	Depth of Cut	SHK DIA	Price
7025	2W Insert Spoilboard - #/Wings: 2	2 1/2	1/2	1/2	\$298.50
7030	3W Insert Spoilboard #/Wings: 3	3	1/2	3/4	\$323.72
7040	3W Insert Spoilboard #/Wings: 3	4	1/2	3/4	\$332.13

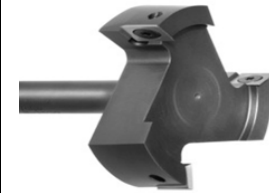

Insert Round & Rout Cutters - Body Part #8211

8211	Round & Rout Insert Body - Sm Dia .500	\$ 324.35
------	--	-----------

Insert Round & Rout Cutters - Insert Part for #8211

Insert #	Description	SM DIA	RADIUS	SHK DIA	PRICE
INS-8211	1/8"R Replacement Insert	0.500	1/8	3/4	\$25.71
INS-8212	3/16"R Replacement Insert	0.500	3/16	3/4	\$25.71
INS-8213	1/4"R Replacement Insert	0.500	1/4	3/4	\$25.71
INS-7830	5/16"R Replacement Insert	0.500	5/16	3/4	\$25.71
INS-8214	3/8"R Replacement Insert	0.500	3/8	3/4	\$25.71



Flat Table Dovetail Drawer System

Part #	Description	SHK DIA	Price
7500	Insert Body 9101. 4 - INS-9101 Inserts; 2 - 3115 1/4" comp. spirals)	3/4	\$568.41
7600	Insert Body 9101. 4 - INS-9282 Inserts; 2 - 3115 1/4" comp. spirals)	3/4	\$568.41

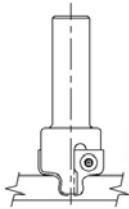

KIT #7500 - Round Edge

Includes:
 Insert Body 9101
 4 - INS-9101 Inserts
 2 - 3115 (1/4" compression spirals)

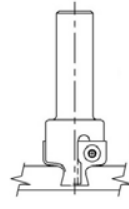

KIT #7600 - Square Edge

Includes:
 Insert Body 9101
 4 - INS-9282 Inserts
 2 - 3115 (1/4" compression spirals)

3W C.T. Slotting Cutters



Part #	Description	CED	KERF	SHK DIA	DEPTH OF CUT	Price
6600	3W Slotting Cutter	2"	.075 Kerf	1/2"	3/4	\$105.71
6605	3W Slotting Cutter	2"	.093" Kerf	1/2"	3/4	\$105.71
6610	3W Slotting Cutter	2"	.125" Kerf	1/2"	3/4	\$105.71
6615	3W Slotting Cutter	2"	.187" Kerf	1/2"	3/4	\$111.17
6620	3W Slotting Cutter	2"	.250" Kerf	1/2"	3/4	\$111.17

Insert Shaker Door Cutters



Part #	Description	CED	Depth of Cut	SHK DIA	WINGS	Price
8300	Insert Shaker Door Cutter	1 1/4	1/2"	1/2	2 wings	\$222.82

Tapered Upcut Spiral for Wood Doors



Part #	Description	CED	CEL	SHK DIA	OAL	Price
8534	TaperedUpcut Spiral	3/4"	2 1/2	3/4	5	\$357.25

W. L. FULLER, INC.

Type 'C' 4 Flute Countersinks - 82° Angle

PART	CUTTING DIAMETER	DRILL HOLE SIZE	OVERALL LENGTH	PRICE
C2	1/4	5/64	3/4	\$7.88
C3	1/4	3/32	3/4	\$7.88
C4	5/16	7/64	7/8	\$7.88
C44	5/16	1/8	7/8	\$7.88
C65	5/16	9/64	7/8	\$7.88
C410	5/16	5/32	7/8	\$7.88
C411	5/16	11/64	7/8	\$7.88
C43	5/16	3/16	7/8	\$7.88
C56	3/8	3/32	7/8	\$7.88
C57	3/8	7/64	7/8	\$7.88
C5	3/8	1/8	7/8	\$7.12
C6	3/8	9/64	7/8	\$7.12
C7	3/8	5/32	7/8	\$7.12
C8	3/8	11/64	7/8	\$7.12
C9	3/8	3/16	7/8	\$7.12
C913	3/8	13/64	7/8	\$7.12
C97	3/8	7/32	7/8	\$7.12
C105	7/16	5/32	7/8	\$7.88
C1011	7/16	11/64	7/8	\$7.88
C103	7/16	3/16	7/8	\$7.88
C10	7/16	13/64	7/8	\$7.88
C1014	7/16	7/32	7/8	\$7.88
C104	7/16	1/4	7/8	\$7.88
C122	1/2	1/8	7/8	\$7.88
C129	1/2	9/64	7/8	\$7.88
C125	1/2	5/32	7/8	\$7.88
C92	1/2	3/16	7/8	\$7.88
C102	1/2	13/64	7/8	\$7.88
C12	1/2	7/32	7/8	\$7.88
C1415	1/2	15/64	7/8	\$7.88
C14	1/2	1/4	7/8	\$7.88
C145	5/8	5/32	1-1/16	\$10.54
C143	5/8	3/16	1-1/16	\$10.54
C167	5/8	7/32	1-1/16	\$10.54
C244	3/4	1/4	1-1/8	\$13.91
C245	3/4	5/16	1-1/8	\$13.91
C20	3/4	21/64	1-1/8	\$13.91
C24	3/4	3/8	1-1/4	\$13.91
C284	7/8	1/4	1-1/4	\$17.79
C285	7/8	5/16	1-1/4	\$17.79
C286	7/8	3/8	1-1/4	\$17.79
C287	7/8	7/16	1-3/8	\$17.79
C324	1	1/4	1-3/8	\$21.03
C326	1	3/8	1-3/8	\$21.03
C328	1	1/2	1-1/2	\$21.03



Type 'C' 4 Flute Countersinks - (Cont.)

PART	CUTTING DIAMETER	DRILL HOLE SIZE	OVERALL LENGTH	PRICE
C16	5/8	1/4	1-1/16	\$10.54
C18	5/8	5/16	1-1/16	\$10.54
C169	5/8	9/32	1-1/16	\$10.54
C243	3/4	3/16	3/16	\$13.91
C247	3/4	7/32	1-1/8	\$13.91
C1617	5/8	17/64	1-1/16	\$10.54
C1619	5/8	19/64	1-1/16	\$10.54

Type C Countersink Sets

Item #	Set Name	Sizes Included in Set	# of Pieces in Set	Price
10390006	No. 6 Set	C56 thru C913	13	\$79.02

Stop Collars

PART	INSIDE DIAMETER	WIDTH	PRICE
11900250	1/4	1/4	\$2.67
11900312	5/16	1/4	\$2.73
11900375	3/8	1/4	\$2.92
11900437	7/16	1/4	\$3.24
11900500	1/2	1/4	\$3.31
11900562	9/16	1/4	\$3.50
11900625	5/8	1/4	\$3.94
11900750	3/4	1/4	\$4.06
11900875	7/8	1/4	\$4.19
11901000	1	5/16	\$4.58

Ferro-Tic Carbide Countersinks

PART	CUTTING DIAMETER	DRILL HOLE SIZE	PRICE
CC5	3/8	1/8	\$42.69
CC6	3/8	9/64	\$42.69
CC7	3/8	5/32	\$42.69
CC8	3/8	11/64	\$42.69
CC9	3/8	3/16	\$42.69
CC125	1/2	5/32	\$50.05
CC1211	1/2	11/64	\$50.05
CC92	1/2	3/16	\$50.05
CC102	1/2	13/64	\$50.05
CC12	1/2	7/32	\$50.05
CC14	1/2	1/4	\$50.05
CC143	5/8	3/16	\$67.98
CC16	5/8	1/4	\$67.98
CC169	5/8	9/32	\$67.98
CC18	5/8	5/16	\$67.98
CC244	3/4	1/4	\$67.98
CC245	3/4	5/16	\$97.58
CC24	3/4	3/8	\$97.58

W. L. FULLER, INC.

High Speed Steel Taper Point Drill Sizes and Lengths

WOOD SCREW SIZE	DRILL SIZE	REGULAR	FAST SPIRAL PART	PRICE	PRICE	FLUTE LENGTH	OVERALL LENGTH	SHORT LENGTH PART	PRICE
2	5/64	1	2	20100078	\$3.99	20800078			\$6.35
3	3/32	1-1/4	2-1/4	20100093	\$3.99	20800093			\$6.54
4	7/64	1-1/2	2-5/8	20100109	\$4.10	20800109			\$6.73
5	1/8	1-5/8	2-3/4	20100125	\$3.99	20800125	7/8	1-7/8	20000125 \$4.41
6	9/64	1-3/4	2-7/8	20100140	\$4.25	20800140			\$8.00
7	5/32	2	3-1/8	20100156	\$4.25	20800156	1	2-1/16	20000156 \$4.73
8	11/64	2	3-1/8	20100171	\$4.46	20800171	1-1/16	2-1/8	20000171 \$4.78
9	3/16	2-5/16	3-1/2	20100187	\$4.67	20800187	1-1/8	2-3/16	20000187 \$4.99
10	13/64	2-7/16	3-5/8	20100203	\$4.88	20800203			\$10.04
12	7/32	2-1/2	3-3/4	20100218	\$5.20	20800218	1-1/4	2-3/8	20000218 \$5.36
14	15/64	2-5/8	3-7/8	20100234	\$5.41	20800234	1-5/16	2-7/16	20000234 \$5.67
14	1/4	2-3/4	4	20100250	\$5.72	20800250	1-3/8	2-1/2	20000250 \$5.99
16	17/64	2-7/8	4-1/8	20100265	\$6.77	20800265			\$13.15
16	9/32	2-15/16	4-1/4	20100281	\$7.35	20800281			\$13.08
18	19/64	3-1/16	4-3/8	20100296	\$7.88	20800296			\$14.23
18-20	5/16	3-3/16	4-1/2	20100312	\$8.09	20800312	1-5/8	2-13/16	20000312 \$6.77
20	21/64	3-5/16	4-5/8	20100328	\$8.82	20800328			\$16.58
20	11/32	3-7/16	4-3/4	20100343	\$9.56	20800343			\$17.08
24	23/64	3-1/2	4-7/8	20100359	\$10.55	20800359			\$19.44
24	3/8	3-5/8	5	20100375	\$10.55	20800375	1-13/16	3-1/8	20000375 \$8.45

Drill Stops



3/8" Diameter by 1/2" Overall Length

Drill Size	Decimal	Stock Number	Price
1/8	0.1250	10600125	\$ 2.73

7/16" Diameter by 1/2" Overall Length

Drill Size	Decimal	Stock Number	Price
3/16	0.1875	10600187	\$ 2.92

1/2" Diameter by 1/2" Overall Length

Drill Size	Decimal	Stock Number	Price
1/4 E	0.2500	10600250	\$ 3.24

5/8" Diameter by 5/8" Overall Length

Drill Size	Decimal	Stock Number	Price
5/16	0.3125	10600312	\$ 4.77

7/8" Diameter by 7/8" Overall Length

Drill Size	Decimal	Stock Number	Price
3/8	0.3750	10600375	\$ 4.77
1/2	0.5000	10600500	\$ 6.04

1-1/8" Diameter by 1-1/8" Overall Length

Drill Size	Decimal	Stock Number	Price
5/8	0.6250	10600625	\$ 9.08

1-1/2" Diameter by 1-1/2" Overall Length

Drill Size	Decimal	Stock Number	Price
1	1.000	10601000	\$ 16.96

Replacement Taper Point Drills for the TPS-Lock System

Replacement Drill Size	Tapered Drill with TPS-Lock#	TPS-Lock Shank#	Replacement Drill #	Price
9/64	20140140	QST09	20130140	\$ 6.60
11/64	20140171	QST11	20130171	\$ 6.86

"HSS" Countersinks

Stock #	Cutting Dia	Drill Hole Dia	OA Length	Price
H287S	7/8"	7/16"	1-3/8	\$ 28.59

Type "X" Counterbores

Stock Number	Cutting Dia.	Overall Length	Drill Size	Price
*X3L	5/8	1	3/16	\$16.26
X43L	3/4	1	3/16	\$18.29
*X4L	3/4	1	1/4	\$18.29
X64L	7/8	1-1/8	1/4	\$22.87
X74L	1	1-1/8	1/4	\$27.64
*X7L	1	1-3/8	7/16	\$27.64
X10L	1-3/8	2	5/8	\$45.11







Special Sizes - Quotation on Request

W. L. FULLER, INC.

Plug Cutters To Cut Your Own Wood Plugs

Designed for clean cutting and hardened for long life. These two and four-bladed Plug Cutters do not eject the plugs. The plug remains in the board and can be broken out with a screwdriver or the board can be sawed to free the plug. These tools cut fast and make smooth chamfered plugs for easy starting in counterbored holes.

DIMENSIONS		STANDARD TYPE 4 FLUTE PLUG CUTTERS PART			TAPERED PLUG CUTTERS	SS TYPE 4 FLUTE PLUG CUTTERS PART		CARBIDE TIPPED 2 FLUTE PLUG CUTTERS PART	
PLUG SIZE	MAX. LENGTH	1/4" (D) SHANK	3/8" (D) SHANK	1/2" (D) SHANK	1/4" (D) SHANK	3/8" (D) SHANK	1/2" (D) SHANK	3/8" (D) SHANK	1/2" (D) SHANK
1/4	3/8	11640250	--	--	11640250T	--	--	11860250	--
5/16	3/8	11640312	--	--	--	--	--	11860312	--
8mm	3/8	11640315	--	--	--	--	--	--	--
3/8	1/2	11640375	11660375	--	11640375T	11700375	--	11860375	--
10mm	1/2	11640393	--	--	--	--	--	--	--
7/16	1/2	11640437	11660437	--	--	11700437	--	11860437	--
12mm	1/2	11640472	--	--	--	--	--	--	--
1/2	1/2	11640500	11660500	--	11640500T	11700500	--	11860500	--
13mm	1/2	11640511	--	--	--	--	--	--	--
14mm	1/2	11640551	--	--	--	--	--	--	--
9/16	9/16	11640562	11660562	--	--	--	--	11860562	--
15mm	9/16	11640590	--	--	--	--	--	--	--
5/8	5/8	11640625	11660625	--	11640625T	11700625	--	11860625	--
16mm	5/8	11640629	--	--	--	--	--	--	--
3/4	3/4	--	--	11680750	--	--	11700750	--	11880750
7/8	3/4	--	--	11680875	--	--	11700875	--	11880875
1	3/4	--	--	11681000	--	--	11701000	--	11881000
1-1/8	3/4	--	--	11681125	--	--	--	--	11881125
1-1/4	3/4	--	--	11681250	--	--	--	--	11881250
1-3/8	3/4	--	--	11681375	--	--	--	--	11881375
1-1/2	3/4	--	--	11681500	--	--	--	--	11881500

 <p>Standard Plug Cutter Suitable for both soft and most hardwoods. Plug diameter is slightly larger than counterbore diameter for a tight fit every time.</p>	 <p>Tapered Plug Cutter Suitable for both soft and most hardwoods. Plug diameter is tapered slightly from on size to .010" oversize. All sizes have 1/4" shank</p>	 <p>SS Plug Cutter For hardwoods like oak and Teak. Plug diameter is slightly larger than counterbore diameter for a tight fit every time.</p>	 <p>Carbide Tipped 2 Flute Plug Cutter For high production in hardwoods like oak and teak and abrasive materials. Plug diameter is slightly larger than counterbore diameter for a tight fit every time.</p>
--	--	---	--

Tenon Cutters for Wood - 4 Flute

PART	OUTSIDE DIAMETER	TENON SIZE	TENON LENGTH	PRICE
T4	3/4	1/4	1/2	\$42.43
T6	1-1/4	3/8	5/8	\$51.59
T8	1-1/4	1/2	5/8	\$54.69
T10	1-3/8	5/8	3/4	\$72.23
T12	1-1/2	3/4	3/4	\$85.44

To make round Tenons on any shape wood parts with width not more than outside diameter of cutter. All sizes with 1/2" shank to fit chuck. Other Tenon sizes, outside diameter or shank sizes quotation on request.

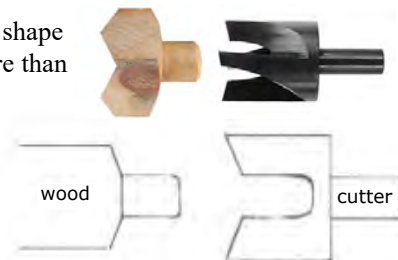

W. L. FULLER, INC.

Metric Regular Length Brad Point Drills					
mm Size	Dec. Equiv.	Flute Length	O.A. Length	Series 281 HSS Brad Point-RH	Price
2.0	0.0787	15/16"	1-15/16"	28100078	\$ 4.96
2.5	0.0984	1-3/16"	2-1/4"	28100098	\$ 5.27
3.0	0.1181	1-5/16"	2-13/32"	28100118	\$ 5.33
3.5	0.1378	1-3/4"	2-7/8"	28100137	\$ 5.59
4.0	0.1575	1-11/16"	2-15/16"	28100157	\$ 6.23
5.0	0.1968	2-1/16"	3-3/8"	28100196	\$ 6.79
6.0	0.2362	2-1/4"	3-21/32"	28100236	\$ 7.88
6.5	0.2559	2-15/32"	3-31/32"	28100255	\$ 8.64
10.5	0.4134	3-7/16"	5-1/4"	28100413	\$ 17.16

Regular Length - Metric Sizes					
mm Size	Dec. Equiv.	Flute Length	O.A. Length	Series 181 Regular Point	Price
1.0	0.0394	15/32	1-11/32"	18100039	\$ 1.93
1.5	0.0591	23/32	1-9/16"	18100059	\$ 2.08
2.0	0.0787	15/16	1-15/16"	18100078	\$ 1.95
2.5	0.0984	1-3/16	2-1/4"	18100098	\$ 2.08
3.0	0.1181	1-5/16	2-13/32"	18100118	\$ 2.10
3.5	0.1378	1-3/4	2-7/8"	18100137	\$ 2.29
4.0	0.1575	1-11/16	2-15/16"	18100157	\$ 2.52
5.0	0.1968	2-1/16	3-3/8"	18100196	\$ 3.09
6.0	0.2362	2-1/4	3-21/32"	18100236	\$ 3.97
6.5	0.2559	2-15/32	3-31/32"	18100255	\$ 4.73

Regular / Jobbers Length Drills Reg. Brad Point

PART	SIZE	DECIMAL EQUIVALENT	FLUTE LENGTH	OVERALL LENGTH	PRICE
25100078	5/64	.0781	1	2	\$4.06
25100093	3/32	.0937	1-1/4	2-1/4	\$4.13
25100109	7/64	.1094	1-1/2	2-5/8	\$4.32
25100125	1/8	.1250	1-5/8	2-3/4	\$4.52
25100140	9/64	.1406	1-3/4	2-7/8	\$4.70
25100156	5/32	.1562	2	3-1/8	\$4.77
25100171	11/64	.1719	2-1/8	3-1/4	\$5.27
25100187	3/16	.1875	2-5/16	3-1/2	\$5.52
25100203	13/64	.2031	2-7/16	3-5/8	\$5.85
25100218	7/32	.2188	2-1/2	3-3/4	\$6.23
25100234	15/64	.2344	2-5/8	3-7/8	\$6.42
25100250	1/4	.2500	2-3/4	4	\$7.37
25100265	17/64	.2656	2-7/8	4-1/8	\$7.37
25100281	9/32	.2812	2-15/16	4-1/4	\$8.06
25100296	19/64	.2969	3-1/16	4-3/8	\$8.58
25100312	5/16	.3125	3-3/16	4-1/2	\$8.77
25100328	21/64	.3281	3-5/16	4-5/8	\$9.33
25100343	11/32	.3438	3-7/16	4-3/4	\$10.35
25100359	23/64	.3594	3-1/2	4-7/8	\$11.06
25100375	3/8	.3750	3-5/8	5	\$11.37
25100390	25/64	.3906	3-3/4	5-1/8	\$12.71
25100406	13/32	.4062	3-7/8	5-1/4	\$12.89
25100421	27/64	.4219	3-15/16	5-3/8	\$13.72
25100437	7/16	.4375	4-1/16	5-1/2	\$14.23
25100453	29/64	.4531	4-3/16	5-5/8	\$15.89
25100468	15/32	.4688	4-5/16	5-3/4	\$16.01
25100484	31/64	.4844	4-3/8	5-7/8	\$16.89
25100500	1/2	.5000	4-1/2	6	\$20.09
25100531	17/32	.5156	4-13/16	6-5/8	\$33.93
25100578	37/64	.5781	4-13/16	6-5/8	\$38.88

Series 251 Brad Point - For clean holes in wood, plastic and sheet metal.

Regular or Jobbers Length Drills Regular Point

PART	SIZE	DECIMAL EQUIVALENT	FLUTE LENGTH	OVERALL LENGTH	PRICE
15100078	5/64	.0781	1	2	\$1.87
15100093	3/32	.0937	1-1/4	2-1/4	\$1.87
15100109	7/64	.1094	1-1/2	2-5/8	\$1.40
15100125	1/8	.1250	1-5/8	2-3/4	\$1.91
15100140	9/64	.1406	1-3/4	2-7/8	\$2.12
15100156	5/32	.1562	2	3-1/8	\$2.14
15100171	11/64	.1719	2-1/8	3-1/4	\$2.34
15100187	3/16	.1875	2-5/16	3-1/2	\$2.60
15100203	13/64	.2031	2-7/16	3-5/8	\$2.89
15100218	7/32	.2188	2-1/2	3-3/4	\$3.20
15100234	15/64	.2344	2-5/8	3-7/8	\$3.49
15100250	1/4	.2500	2-3/4	4	\$3.43
15100265	17/64	.2656	2-7/8	4-1/8	\$4.43
15100281	9/32	.2812	2-15/16	4-1/4	\$4.59
15100296	19/64	.2969	3-1/16	4-3/8	\$5.30
15100312	5/16	.3125	3-3/16	4-1/2	\$5.86
15100328	21/64	.3281	3-5/16	4-5/8	\$6.52
15100343	11/32	.3438	3-7/16	4-3/4	\$7.27
15100359	23/64	.3594	3-1/2	4-7/8	\$8.18
15100375	3/8	.3750	3-5/8	5	\$8.28
15100390	25/64	.3906	3-3/4	5-1/8	\$9.58
15100406	13/32	.4062	3-7/8	5-1/4	\$9.82
15100421	27/64	.4219	3-15/16	5-3/8	\$10.94
15100437	7/16	.4375	4-1/16	5-1/2	\$11.35
15100453	29/64	.4531	4-3/16	5-5/8	\$12.69
15100468	15/32	.4688	4-5/16	5-3/4	\$13.49
15100484	31/64	.4844	4-3/8	5-7/8	\$14.15
15100500	1/2	.5000	4-1/2	6	\$14.11
15800187	3/16	.1875	2-5/16	3-1/2	\$3.63

Series 151 Regular Point - General purpose for drilling materials such as wood, plastic and metal.

Brad Point Drill Sets

Brad Point Drill Sets	Number Pieces	Size Range	Length	Price
25195028	29	1/16 to 1/2 by 64ths	Regular Length	\$ 266.49



Reduced Shank Brad Point Drill

Sets #41092007 **\$65.44**

Drill Dia.	OA Lgth	Shank Size
*1/8	2-3/4	1/8
*3/16	3-1/2	3/16
1/4	4	1/4
5/16	4	1/4
3/8	4	1/4
7/16	4	1/4
1/2	4	1/4

*Sizes below 1/4" have straight shanks

W. L. FULLER, INC
1/2" Reduced Shank Drills - 3" Twist

Drill Dia.	340 Series		350 Series	
	HSS Brad Point	Price	HSS Reg Point	Price
9/64	34000140	\$ 16.08	35000140	\$ 12.77
11/64	34000171	\$ 17.35	X	
1/2	34000500	\$ 20.09	35000500	\$ 14.11
1/4	34000250	\$ 19.12	35000250	\$ 14.42
3/4	34000750	\$ 34.24	35000750	\$ 23.05
3/8	34000375	\$ 22.47	X	
5/8	34000625	\$ 27.70	35000625	\$ 19.07
5/16	34000312	\$ 20.97	35000312	\$ 15.95
7/8	X		35000875	\$ 28.18
9/16	34000562	\$ 25.10	35000562	\$ 17.08
11/16	34000687	\$ 30.43	35000687	\$ 21.25
17/32	34000531	\$ 23.70	35000531	\$ 16.19
19/32	34000593	\$ 27.12	35000593	\$ 18.88
21/32	34000656	\$ 29.73	35000656	\$ 20.59
23/32	34000718	\$ 33.41	35000718	\$ 22.56
29/32	34000906	\$ 44.90	X	
31/32	X		35000968	\$ 35.45
33/64	34000515	\$ 24.52	35000515	\$ 17.05
35/64	34000546	\$ 26.18	35000546	\$ 18.17
37/64	34000578	\$ 27.51	35000578	\$ 19.24
39/64	34000609	\$ 28.91	35000609	\$ 20.29
41/64	34000640	\$ 30.56	35000640	\$ 21.40
43/64	34000671	\$ 31.57	35000671	\$ 22.41
45/64	34000703	\$ 34.30	35000703	\$ 23.44
47/64	34000734	\$ 35.70	35000734	\$ 24.55
63/64	X		35000984	\$ 38.46
1	34001000	\$ 36.13	34001000	\$ 36.13

Series 340 High Speed Steel Brad Point

For clean, accurately sized holes in hardwoods and plastics.

Sizes 1/8" to 15/64" are 5" overall length.

Sizes 1/4" to 1-1/2" are 6" overall length.

All sizes have 3" of twist. Can be specifically ground for softer woods if specified when ordering. Can be ordered with long brad points for angle drilling.



Series 350 High Speed Steel Regular Point

For through holes in woods, plastics and metals.

Sizes 1/8" to 15/64" are 5" overall length. Sizes

1/4" to 1-1/2" are 6" overall length.

All sizes have 3" of twist



High Speed Steel Step Drills - 82° or 180° Countersink Angle



PART	SCREW HOLE SIZE	A COUNTERSINK DIAMETER	B PILOT DIA.	C PILOT LENGTH	D FLUTE LENGTH	E OVERALL LENGTH	F SHANK DIA.	PRICE
SD2	2	3/16	.090	3/16	1-1/8	2-3/16	3/16	\$10.10
SD3	3	7/32	.103	3/16	1-1/4	2-3/8	7/32	\$10.87
SD4	4	15/64	.116	3/16	1-5/16	2-7/16	15/64	\$11.75
SD5	5	17/64	.129	1/4	1-7/16	2-5/8	1/4	\$12.45
SD6	6	19/64	.142	1/4	1-9/16	2-3/4	1/4	\$13.60
SD7	7	21/64	.155	1/4	1-11/16	2-15/16	1/4	\$14.29
SD8	8	11/32	.168	1/4	1-11/16	3	1/4	\$15.37
SD9	9	3/8	.182	1/4	1-13/16	3-1/8	3/8	\$16.33
SD10	10	13/32	.195	1/4	1-15/16	3-5/16	3/8	\$17.47
SD12	12	29/64	.221	5/16	2-1/8	3-9/16	3/8	\$21.22
SD14	14 or 1/4	1/2	.255	5/16	2-1/4	3-3/4	1/2	\$22.81
SD16	16 or 9/32	9/16	.286	5/16	2-1/2	5	1/2	\$30.87
SD18	18 or 5/16	5/8	.317	3/8	2-1/2	5	1/2	\$34.37
SD20	20	11/16	.328	3/8	2-1/2	5	1/2	\$43.90
SD24	24 or 3/8	3/4	.380	3/8	2-1/2	5	1/2	\$47.13

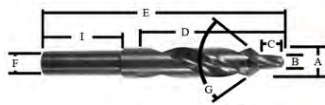

For high production in woods, plastics and metals. Made of High Speed Steel. With 82-degree included angle or 180-degree flat step. Drill and Countersink or Counterbore in one operation, clearance for the head and body of various types of screw. Flutes are less likely to clog compared with two-piece Countersink and Drill combination particularly in materials such as aluminum.

Plexi-Point Drills

* 6" OAL with 1/2" shank

** Minimum quantities of 6 or 12 may apply

Drill Size	Dec. Equiv.	Flute Length	O.A. Length	Stock Number	Price
1/2	.5000	4-1/2	6	14400500	\$ 20.08
1/4	.2500	2-3/4	4	14400250	\$ 7.43
3/4	.7500	3	6	14400750	\$ 45.42
5/8	.6250	3	6	14400625	\$ 27.70
3/8	.3750	3-5/8	5	14400375	\$ 13.35
1/16	.0625	7/8	1-7/8	14400062	\$ 4.83
3/16	.1875	2-5/16	3-1/2	14400187	\$ 6.29
5/16	.3125	3-3/16	4-1/2	14400312	\$ 10.23
7/16	.4375	4-1/16	5-1/2	14400437	\$ 16.96
9/16	.5625	3	6	14400562	\$ 25.10
3/32	.0938	1-1/4	2-1/4	14400093	\$ 4.83
5/32	.1562	2	3-1/8	14400156	\$ 5.46
7/32	.2188	2-1/2	3-3/4	14400218	\$ 7.12
9/32	.2812	2-15/16	4-1/4	14400281	\$ 8.70
11/32	.3438	3-7/16	4-3/4	14400343	\$ 12.00
13/32	.4062	3-7/8	5-1/4	14400406	\$ 15.31
5/64	.0781	1	2	14400078	\$ 7.46
7/64	.1094	1-1/2	2-5/8	14400109	\$ 4.58
9/64	.1406	1-3/4	2-7/8	14400140	\$ 5.40
11/64	.1719	2-1/8	3-1/4	14400171	\$ 6.54
13/64	.2031	2-7/16	3-5/8	14400203	\$ 6.54
15/64	.2344	2-5/8	3-7/8	14400234	\$ 7.43
17/64	.2656	2-7/8	4-1/8	14400265	\$ 8.39
19/64	.2969	3-1/16	4-3/8	14400296	\$ 9.53
21/64	.3281	3-5/16	4-5/8	14400328	\$ 10.93
23/64	.3594	3-1/2	4-7/8	14400359	\$ 12.96
25/64	.3906	3-3/4	5-1/8	14400390	\$ 15.06
27/64	.4219	3-15/16	5-3/8	14400421	\$ 16.45
29/64	.4531	4-3/16	5-5/8	14400453	\$ 18.43
31/64	.4844	4-3/8	5-7/8	14400484	\$ 20.14

Short Length - Standard Point Drills

Size	Dec. Equiv	Flute Length	Overall Length	HSS Regular Point	Price
7/64	0.1094	13/16	1-13/16	15000109	\$ 1.64
3/16	0.1875	1-1/8	2-3/16	15000187	\$ 2.10
1/4	0.2500	1-3/8	2-1/2	15000250	\$ 3.14
5/16	0.3125	1-5/8	2-13/16	15000312	\$ 3.93
3/8	0.3750	1-13/16	3-1/8	15000375	\$ 5.44
7/16	0.4375	2-1/16	3-7/16	15000437	\$ 7.32

WHITESIDE MACHINE

7° ANGLE Dovetail Bits						
PART	LARGE DIAMETER	DEPTH OF CUT	SHANK DIAMETER	OVERALL LENGTH	CROSS REFERENCE	PRICE
D7-530	17/32	3/4	1/4	2-1/2	--	\$18.35
D7-531	17/32	3/4	1/2	2-1/2	P·C 43776PC	\$18.35
D7-622 NEW	5/8	7/8	1/4	2-3/8	--	\$17.70
D7-625	5/8	7/8	1/2	2-5/8	Incra™	\$22.11
D7-748 NEW	3/4	7/8	1/4	2-3/8	--	\$20.02
D7-750	3/4	7/8	1/2	2-5/8	Incra™	\$25.03
D7-875	7/8	7/8	1/2	2-1/2	Stair Tread	\$28.53
D7-875LH	7/8	7/8	1/2	2-1/2	Stair Tread	\$33.04

7-1/2° ANGLE						
PART	LARGE DIAMETER	DEPTH OF CUT	SHANK DIAMETER	OVERALL LENGTH	CROSS REFERENCE	PRICE
D75-25*	1/4	5/16	1/4	2-1/2	Incra™/ OmniJig® 43639	\$18.11

8° ANGLE						
PART	LARGE DIAMETER	DEPTH OF CUT	SHANK DIAMETER	OVERALL LENGTH	CROSS REFERENCE	PRICE
D8-250*	1/4	1/4	1/4	2-1/2	Leigh 50	\$18.53
D8-250x8	1/4	1/4	8mm	2-1/2	Leigh 50	\$23.36
D8-250x8 LH	1/4	1/4	8mm	2-1/2	Leigh 50	\$23.36
D8-312	5/16	3/8	1/4	2-1/4	Leigh 60	\$17.02
D8-312x8	5/16	3/8	8mm	2-1/4	Leigh 60	\$20.03
D8-375	3/8	1/2	1/4	2-3/8	Leigh 70	\$15.19
D8-375x8	3/8	1/2	8mm	2-3/8	Leigh 70	\$17.52
D8-437	7/16	5/8	1/4	2-3/8	Leigh 75	\$17.86
D8-437x8	7/16	5/8	8mm	2-3/8	Leigh 75	\$21.53
D8-500	1/2	13/16	1/4	2-3/4	Leigh 80	\$17.02
D8-500x8	1/2	13/16	8mm	2-3/4	Leigh 80	\$20.61
D8-687	11/16	1	1/2	3	Leigh 90	\$20.61
D8-812	13/16	1 1/4	1/2	3-1/4	Leigh 100	\$22.11

9° ANGLE						
PART	LARGE DIAMETER	DEPTH OF CUT	SHANK DIAMETER	OVERALL LENGTH	CROSS REFERENCE	PRICE
D9-312	5/16	3/8	1/4	2-1/4		\$18.35
D9-372	3/8	3/8	1/4	2	Incra™	\$16.64
D9-373	3/8	3/8	3/8	2	---	\$17.86
D9-375	3/8	3/8	1/2	2	---	\$17.86
D9-375LH	3/8	3/8	1/2	2	---	\$19.61
D9-376	3/8	3/8	1/2	2-1/2	Incra™	\$18.53
D9-376LH	3/8	3/8	1/2	2-1/2	Incra™	\$20.61
D9-390	.390	3/8	1/2	2	---	\$17.85
D9-390LH	.390	3/8	1/2	2	---	\$19.62

10° ANGLE						
PART	LARGE DIAMETER	DEPTH OF CUT	SHANK DIAMETER	OVERALL LENGTH	CROSS REFERENCE	PRICE
D10-50	1/2	5/8	1/4	2-1/2	Incra™ / Leigh 101	\$16.64
D10-50x8 NEW	1/2	5/8	8mm	2-1/2	Incra™ / Leigh 101	\$20.86
D10-55	1/2	5/8	1/2	2-5/8	Incra™	\$19.40

14° ANGLE						
PART	LARGE DIAMETER	DEPTH OF CUT	SHANK DIAMETER	OVERALL LENGTH	CROSS REFERENCE	PRICE
D14-375	3/8	3/8	1/4	2	---	\$17.52
D14-50	1/2	1/2	1/4	2	Incra / OmniJig 43705	\$16.19
D14-51	1/2	1/2	1/4	2-3/8	Leigh 120	\$17.02
D14-51x8	1/2	1/2	8mm	2-3/8	Leigh 120	\$20.36
D14-55	1/2	1/2	1/2	2-1/2	Incra™ / OmniJig® 43750	\$19.61
D14-531	17/32	1/2	1/4	2	Incra™	\$20.03
D14-72 NEW	3/4	3/4	1/4	2-3/8		\$15.09
D14-75	3/4	3/4	1/2	3	OmniJig® 43774	\$18.86
D14-100	1	7/8	1/2	2-1/2	---	\$30.45

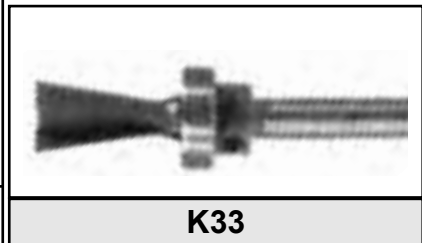
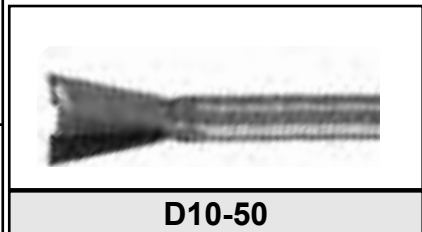
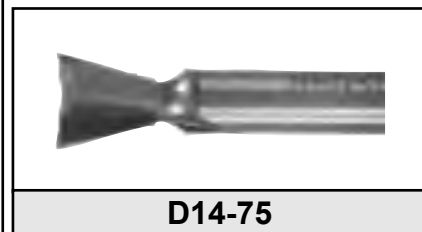
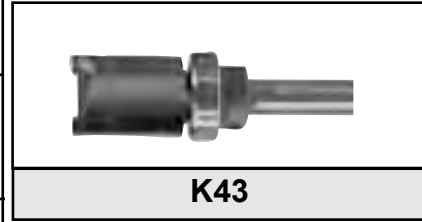

* Solid Carbide
 LH - Indicates Left Hand tool
 All bits designated Incra™ are also compatible with the JointTech™ system.

WHITESIDE MACHINE

Dovetail Bits cont.

18° ANGLE

PART	LARGE DIAMETER	DEPTH OF CUT	SHANK DIAMETER	OVERALL LENGTH	CROSS REFERENCE	PRICE
D18-50	1/2	3/8	1/4	2-1/4	Leigh 128	\$16.64
D18-50x8	1/2	3/8	8mm	2-1/4	Leigh 128	\$20.78

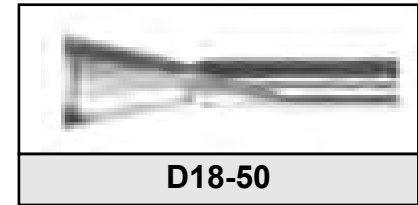

D18-50

STRAIGHT BITS

PART	LARGE DIAMETER	DEPTH OF CUT	SHANK DIAMETER	OVERALL LENGTH	CROSS REFERENCE	PRICE
1020	5/16	1	1/4	2-3/4	Leigh 140	\$13.45
1020x8	5/16	1	8mm	2-3/4	Leigh 140-8mm shank	\$15.84
1064A	13/32	1	1/2	2-1/2	P•C 43743PC	\$14.52
1065L NEW	7/16	1-1/4	1/2	3-1/4	Leigh 150	\$15.62
1067 NEW	1/2	1-1/4	1/2	2-7/8	Leigh 160	\$14.10

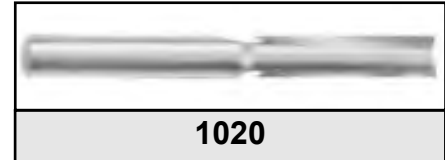

1020

* Solid Carbide

LH - Indicates Left Hand tool

All bits designated Inkra™ are also compatible with the JointTech™ system.

Akeda Dovetail Bits

PART	DESCRIPTION	PRICE
DA7-438 NEW	7 Akeda Dovetail Bit	\$23.50
DA9-438 NEW	9 Akeda Dovetail Bit	\$23.50
DA11-438 NEW	11 Akeda Dovetail Bit	\$23.50
DA14-438 NEW	14 Akeda Dovetail Bit	\$23.50
DA20-438 NEW	20 Akeda Dovetail Bit	\$23.50
1020AKS NEW	Akeda Standard Straight Bit	\$15.36
1020AOS NEW	Akeda Oversize Straight Bit	\$15.36
1020AUS NEW	Akeda Undersize Straight Bit	\$15.36
1020ABJ NEW	Akeda Box Joint Bit	\$18.44
D102A (set) NEW	9 Piece Akeda Complete Set	\$164.90

Inkra™ Dovetail Sets

PART	DESCRIPTION	PRICE
D101 NEW	6 Piece 1/4 Shank Inkra™ Set	\$84.67
605 NEW	6 Piece 1/2 Shank Inkra™ Set	\$95.04

Top Quality Dovetailing Sets for use with the popular Inkra System. Choose the D101 set (1/4" Shank) for the smaller Dovetails (1/4", 3/8", 1/2" and 17/32"), or the 605 Set (1/2" Shank) for the heavier Dovetails (3/8", 1/2", 5/8" and 3/4"). Both Sets also include the 1/4" and 3/8" Box Joint Bits.

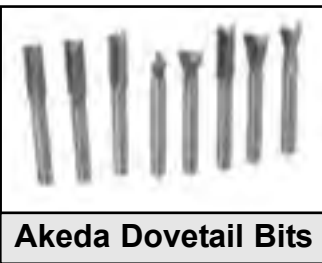

Akeda Dovetail Bits



Leigh Dovetail Bits

Leigh Dovetail Sets

PART	DESCRIPTION	PRICE
D108 NEW	7 Piece 8mm Adapter Leigh Set	\$95.04
D116 NEW	6 Piece Leigh Set	\$84.67

Upgrade to Whiteside Quality USA Bits for your Leigh Jig. The smaller bits are supplied in the recommended 8mm Shanks (1/2" Adapter Collet is included). The largest sizes come in 1/2" shanks. Improved Performance Guaranteed.

Keller Dovetail Bits

7° ANGLE

PART	KELLER LARGE	CUTTING DIA.	CUTTING LENGTH	SHANK DIA.	OAL	PRICE
K31	1631	11/32	3/8	1/4	2-1/4	\$29.20
K33	1633	7/16	3/4	1/4	2-5/8	\$30.04
K35	2435	5/8	1	3/8	2-5/8	\$38.38

STRAIGHT BITS

PART	KELLER LARGE	CUTTING DIA.	CUTTING LENGTH	SHANK DIA.	OAL	PRICE
K41	1641	5/8	1/2	1/4	2-1/4	\$25.03
K43	1643 / 2443	5/8	3/4	1/4	2-1/2	\$26.70
3015	2445	7/8	1	3/8	2-5/8	\$31.70
3032*	1642	9/16	3/4	1/4	2-1/4	\$20.86

*: Box Joint Bit

Whiteside Machine Company offers precision router bits to match Keller's unique dovetailing system. All tools above are supplied with required ball bearings.



Keller Dovetail Bits

WHITESIDE MACHINE

Standard Spiral Bits - Solid Carbide 2 Flute

1/4" SHANK

UPCUT PART	DOWN CUT PART	CUT DIA.	CUT LENGTH	OVERALL LENGTH	PRICE
RU1600	RD1600	1/8	1/2	2	\$16.27
RU1700	RD1700	5/32	5/8	2	\$17.02
RU1800	RD1800	3/16	3/4	2-1/2	\$16.27
RU1900	RD1900	7/32	3/4	2-1/2	\$16.69
RU2075	RD2075	1/4	3/4	2-1/2	\$15.65
RU2100	RD2100	1/4	1	2-1/2	\$16.27

5/16" SHANK

UPCUT PART	DOWN CUT PART	CUT DIA.	CUT LENGTH	OVERALL LENGTH	PRICE
RU3100	RD3100	5/16	1	2-1/2	\$26.70

3/8" SHANK

UPCUT PART	DOWN CUT PART	CUT DIA.	CUT LENGTH	OVERALL LENGTH	PRICE
RU4075	RD4075	3/8	3/4	2-1/2	\$25.03
RU4100	RD4100	3/8	1	2-1/2	\$27.53
RU4125	RD4125	3/8	1-1/4	3	\$29.20

1/2" SHANK

UPCUT PART	DOWN CUT PART	CUT DIA.	CUT LENGTH	OVERALL LENGTH	PRICE
RU4675+	RD4675	1/4	3/4	3	\$22.11
RU4700+	RD4700	1/4	1	3-1/4	\$23.78
RU4800	RD4800	9/32	1	3	\$57.57
RU4850	RD4850	5/16	1	3	\$43.80
RU4875	RD4875	3/8	3/4	3	\$41.30
RU4900	RD4900	3/8	1-1/4	3	\$43.80
RU4950	RD4950	7/16	1-1/4	3	\$43.38
RU5100	RD5100	1/2	1	3	\$39.21
RU5125	RD5125	1/2	1-1/4	3	\$41.30
RU5150	RD5150	1/2	1-1/2	3-1/2	\$44.22
RU5200	RD5200	1/2	2	4	\$54.23

5/8" SHANK

UPCUT PART	DOWN CUT PART	CUT DIA.	CUT LENGTH	OVERALL LENGTH	PRICE
RU6150	RD6150	5/8	1-1/2	3-1/2	\$95.95
RU6200	RD6200	5/8	2	4	\$103.46

3/4" SHANK

UPCUT PART	DOWN CUT PART	CUT DIA.	CUT LENGTH	OVERALL LENGTH	PRICE
RU7150	RD7150	3/4	1-1/2	3-1/2	\$96.78
RU7200	RD7200	3/4	2	4	\$104.29
RU7300	RD7300	3/4	3	5	\$141.83
RU7306+	RD7306	3/4	3	6	\$154.34



Chipbreaker Spiral Bits - Solid Carbide - 2 Flute - 1/2 Shank

UPCUT PART	DOWNCUT PART	CUT DIA.	CUT LENGTH	OVERALL LENGTH	PRICE
RU5125CB	RD5125CB	1/2	1-1/4	3	\$51.73
RU5150CB	RD5150CB	1/2	1-1/2	3-1/2	\$54.23
RU5200CB	RD5200CB	1/2	2	4	\$64.24



Roughing Spiral Bits Solid Carbide - 3 Flute (Hoggers)

UPCUT PART	DOWNCUT PART	CUT DIA.	CUT LENGTH	SHANK DIA.	OVERALL LENGTH	PRICE
RU4000H* NEW		3/8	1	3/8	2-1/8	\$44.06
RU4100H	RD4100H	3/8	1	3/8	2-1/2	\$47.52
RU4125H	RD4125H	3/8	1-1/4	3/8	3	\$48.38
RU5162H	RD5162H	1/2	1-5/8	1/2	4	\$95.04
RU5218H	RD5218H	1/2	2-3/16	1/2	4	\$122.69
RU6200H+	RD6200H+	5/8	2	5/8	4	\$134.78
RU7200H+	RD7200H+	3/4	2	3/4	4	\$158.96
RU7325H+	RD7325H+	3/4	3-1/4	3/4	6	\$214.27

* :For Castle and P-C Pocket Machines.



Spiral Bits - Solid Carbide - 3 Flute

UPCUT PART	DOWNCUT PART	CUT DIA.	CUT LENGTH	SHANK DIA.	OVERALL LENGTH	PRICE
RU4125T	RD4125T	3/8	1-1/4	3/8	3	\$31.70
RU5125T	RD5125T	1/2	1-1/4	1/2	3	\$43.38
RU5200T	RD5200T	1/2	2	1/2	4	\$56.73
RU7200T	RD7200T	3/4	2	3/4	4	\$116.81



O-Flute Slow Spiral Bits Solid Carbide - 2 Flute

UPCUT PART	DOWNCUT PART	CUT DIA.	CUT LENGTH	SHANK DIA.	OVERALL LENGTH	PRICE
RU2076A	RD2076A	1/4	3/4	1/4	2-1/2	\$18.77

Used Primarily for Routing Plastics.



WHITESIDE MACHINE

O-Flute Straight Bits Solid Carbide - Single Flute

PART	CUT DIA.	CUT LENGTH	SHANK DIA.	OVERALL LENGTH	PRICE
SA1600	1/8	3/8	1/4	2-1/2	\$17.23
SA1700	5/32	1/2	1/4	2-1/2	\$20.86
SA1800	3/16	1/2	1/4	2-1/2	\$17.23
SA1900	7/32	5/8	1/4	2-1/2	\$20.86
SA2075	1/4	3/4	1/4	2-1/2	\$17.23
SA2100	1/4	1	1/4	3-1/2	\$21.69
SA4100	3/8	1	3/8	3	\$35.04

Primarily used for routing plastics.



Spiral Bits - Solid Carbide Up and Down Cut

(1+1 COMPRESSION) SINGLE FLUTE

PART	CUT DIA.	CUT LENGTH	SHANK DIA.	OVERALL LENGTH	PRICE
UD2100	1/4	1	1/4	2-1/2	\$30.04
UD4125	3/8	1 1/4	3/8	3	\$51.73
UD5150	1/2	1 1/2	1/2	3-1/2	\$73.42
UD5160	1/2	1 5/8	1/2	3-1/2	\$73.42

(2+2 COMPRESSION) TWO FLUTE

PART	CUT DIA.	CUT LENGTH	SHANK DIA.	OVERALL LENGTH	PRICE
UD2102	1/4	1	1/4	2-1/2	\$28.37
UD4102M*	3/8	1	3/8	2-1/2	\$48.39
UD4122	3/8	1-1/4	3/8	3	\$48.39
UD4122M* NEW	3/8	1-1/4	3/8	3	\$51.73
UD5122	1/2	1-1/4	1/2	3	\$62.57
UD5122M*	1/2	1-1/4	1/2	3	\$66.74
UD5152	1/2	1-1/2	1/2	3-1/2	\$68.42
UD5162	1/2	1-5/8	1/2	3-1/2	\$68.42
UD5162M* NEW	1/2	1-5/8	1/2	3-1/2	\$72.59
UD5202	1/2	2	1/2	4	\$75.09
UD6152	5/8	1-1/2	5/8	4	\$140.16
UD7152	3/4	1-1/2	3/4	4	\$138.50
UD7202	3/4	2	3/4	5	\$163.52

(3+3 COMPRESSION) THREE FLUTE

PART	CUT DIA.	CUT LENGTH	SHANK DIA.	OVERALL LENGTH	PRICE
UD4123M*	3/8	1-1/4	3/8	3	\$61.74
UD5123	1/2	1-1/4	1/2	3	\$73.42
UD5123M*	1/2	1-1/4	1/2	3	\$78.43
UD5143	1/2	1-3/8	1/2	3-1/2	\$80.09
UD5163	1/2	1-5/8	1/2	3-1/2	\$80.09
UD5163M*	1/2	1-5/8	1/2	3-1/2	\$85.10

* :Mortise Style - 1/4 up cut on end.



Flush Trim Spiral Bits Solid Carbide - 2 Flute

UPCUT PART	DOWNCUT PART	CUT DIA.	CUT LENGTH	SHANK DIA.	OVERALL LENGTH	PRICE
RFT1600	RFTD1600	1/8	3/8	1/4	2	\$30.04
RFT2100	RFTD2100	1/4	1	1/4	3	\$33.38
RFT5125	RFTD5125	1/2	1-1/4	1/2	3-3/4	\$65.91
RFT5200	RFTD5200	1/2	2	1/2	4-3/4	\$78.43

These spiral bits offer State-of-the-Art results in Flush trimming. Our 1/4 diameter tools are great for small inside corners. Try our 1/8 diameter for extremely sharp corners. The 1/8 bit uses a brass pilot. All others feature a double bearing guide. Available in your choice of Up or Down Cut.



Slow Spiral Bits - Solid Carbide 3 Flute

UPCUT PART	DOWNCUT PART	CUT DIA.	CUT LENGTH	SHANK DIA.	OVERALL LENGTH	PRICE
RU4100S	RD4100S	3/8	1	3/8	2-1/2	\$35.04
RU5100S	RD5100S	1/2	1	1/2	3	\$45.05
RU5150S	RD5150S	1/2	1-1/2	1/2	3-1/2	\$50.06



Left Hand Spiral Bits - Solid Carbide 2 Flute

UPCUT PART	DOWNCUT PART	CUT DIA.	CUT LENGTH	SHANK DIA.	OVERALL LENGTH	PRICE
LU1600	LD1600	1/8	1/2	1/4	2	\$20.03
LU1800	LD1800	3/16	3/4	1/4	2	\$20.03
LU2100	LD2100	1/4	1	1/4	2-1/2	\$18.77
LU3100	LD3100	5/16	1	5/16	3	\$36.71
LU4100	LD4100	3/8	1	3/8	3	\$36.71
LU5125	LD5125	1/2	1-1/4	1/2	3	\$46.72
LU5200	LD5200	1/2	2	1/2	4	\$66.74
LU6150	LD6150	5/8	1-1/2	5/8	3-1/2	\$141.00
LU6200	LD6200	5/8	2	5/8	4	\$181.88
LU7150	LD7150	3/4	1-1/2	3/4	4	\$137.66
LU7200	LD7200	3/4	2	3/4	4	\$146.00



ULTIMATE 
Up/Down Bits

Part #	Cutting Dia.	Cutting Length	Shank Dia	OAL	Price
UC5050	3/8	1/2	1/2	3	\$ 70.50
UC5057	3/8	3/4	1/2	3	\$ 72.00

O-Flute Spirals Single Flute / Up-Cut / Plastic Cutting

Part #	Cutting Dia.	Cutting Length	Shank Dia	OAL	Price
RU1581A	1/8	1/4	1/4	2	\$ 21.00
RU1601A	1/8	1/2	1/4	2-1/2	\$ 21.75
RU1701A	5/32	5/8	1/4	2-1/2	\$ 22.50
RU1801A	3/16	5/8	1/4	2-1/2	\$ 22.50
RU2074A	1/4	3/4	1/4	2-1/2	\$ 19.50
RU2111A	1/4	1-1/8	1/4	3	\$ 22.50
RU4111A	3/8	1-1/8	3/8	3	\$ 30.00
RU5121A	1/2	1-1/4	1/2	3	\$ 64.50
RU5161A	1/2	1-5/8	1/2	3-1/2	\$ 69.00
RU5201A	1/2	2	1/2	4	\$ 73.50



Up-Cut **HERCULES** 

Part #	Cutting Dia.	Cutting Length	Shank Dia	OAL	Price
HU4125	3/8	1-1/4	3/8	3	\$ 33.75
HU5125	1/2	1-1/4	1/2	3	\$ 50.25

Down-Cut

Part #	Cutting Dia.	Cutting Length	Shank Dia	OAL	Price
HD4125	3/8	1-1/4	3/8	3	\$ 33.75
HD5125	1/2	1-1/4	1/2	3	\$ 50.25

Up/Down-Cut

Part #	Cutting Dia.	Cutting Length	Shank Dia	OAL	Price
HC4122	3/8	1-1/4	3/8	3	\$ 52.50
HC4122M	3/8	1-1/4	3/8	3	\$ 55.50
HC5122	1/2	1-1/4	1/2	3	\$ 69.00
HC5122M	1/2	1-1/4	1/2	3	\$ 72.75

* Mortise Style (Short up-cut flute for shallow dado cuts)

WHITESIDE MACHINE

WHITESIDE "ULTIMATE" FLUSH TRIM/PATTERN ROUTER BITS

"ULTIMATE" Trim Bits are perfect when working with templates or when using a router to finish matching wood surfaces. Whiteside's compression carbide spiral design, along with a ball bearing guide, makes this bit easy to use in the router and produces a superior quality trimmed edge. The "ULTIMATE" Trim series brings industrial engineered bits, previously manufactured for CNC machines, right into your shop.

PART	CUT DIA.	CUT LENGTH	SHANK DIA.	OVERALL LENGTH	PRICE
UDP9112	7/8"	1-1/8"	1/2"	3-3/8"	\$144.83
UDC9112	7/8"	1-1/8"	1/2"	3-3/4"	\$144.83
UDFT9112	7/8"	1-1/8"	1/2"	3-3/4"	\$135.18
UDFT5152	1/2"	1-1/2"	1/2"	4-1/4"	\$98.45



UDC9112



UDP9112



UDFT9112



UDFT5152

WHITESIDE MACHINE

Standard Straight Bits Solid Carbide

SINGLE FLUTE

PART	CUT DIA.	CUT LENGTH	SHANK DIA.	OVERALL LENGTH	PRICE
SC062 +	1/16	3/16	1/4	1-1/2	\$12.52
SC01	1/16	5/16	1/4	1-1/2	\$17.52
SC01A	3/32	5/16	1/4	1-1/2	\$17.52
SC02	1/8	3/8	1/4	1-1/2	\$11.68
SC03	5/32	5/8	1/4	1-1/2	\$12.85
SC04	3/16	1/2	1/4	1-1/2	\$12.77
SC05	7/32	3/4	1/4	2	\$14.10
SC06	1/4	3/4	1/4	2	\$15.12
SC07	1/4	1	1/4	2-1/2	\$17.02
SC08	1/4	1	1/4	3	\$20.27
SC17	5/16	1	5/16	2-1/2	\$26.70

DOUBLE FLUTE

+ : NEW

PART	CUT DIA.	CUT LENGTH	SHANK DIA.	OVERALL LENGTH	PRICE
SC33	1/8	1/4	1/4	2	\$11.89
SC09	1/8	3/8	1/4	1-1/2	\$11.85
SC09A	1/8	3/8	1/4	2	\$12.52
SC156	5/32	3/8	1/4	1-1/2	\$12.18
SC10	5/32	5/8	1/4	1-1/2	\$12.54
SC10A	5/32	5/8	1/4	2	\$13.14
SC34	3/16	3/8	1/4	2	\$12.68
SC11	3/16	1/2	1/4	1-1/2	\$12.85
SC11A	3/16	1/2	1/4	2	\$13.52
SC12	3/16	5/8	1/4	2	\$14.02
SC13	7/32	3/4	1/4	2	\$14.60
SC35	1/4	1/2	1/4	2	\$13.97
SC14	1/4	3/4	1/4	2	\$15.02
SC15	1/4	1	1/4	2-1/2	\$18.17
SC16	1/4	1	1/4	3	\$21.47
SC18	5/16	1	5/16	2-1/2	\$27.05
SC19	3/8	1	3/8	2-1/2	\$28.37
SC19A	3/8	1-1/4	3/8	3	\$30.04
SC218	7/32	3/4	1/2	2-3/4	\$20.86
SC235	15/64	3/4	1/2	2-3/4	\$20.86
SC20	1/4	3/4	1/2	2-3/4	\$22.11
SC21	1/4	1	1/2	3	\$23.78
SC22	5/16	1	1/2	3	\$30.04
SC23	3/8	1	1/2	3	\$35.04
SC24	3/8	1-1/4	1/2	3-1/4	\$37.55
SC25	1/2	1	1/2	3	\$37.55
SC26	1/2	1-1/4	1/2	3	\$39.21
SC27	1/2	1-1/2	1/2	3-1/2	\$40.88

+ : NEW



Flush Trim - 1/4" Cut Length

PART	CUT LENGTH	SHANK DIAMETER	OVERALL LENGTH	PRICE
SC28B	1/4	1/4	1-1/2	\$7.93
SC28B-BLK		20 Pieces - Bulk		\$124.65
		50 Pieces - Bulk		\$293.50
		100 Pieces - Bulk		\$551.50

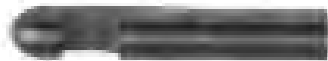

Flush Trim - 3/8" Cut Length

PART	CUTTING LENGTH	SHANK DIAMETER	OVERALL LENGTH	PRICE
SC28	3/8	1/4	1-1/2	\$8.76
SC28-BLK		20 Pieces - Bulk		\$137.95
		50 Pieces - Bulk		\$324.25
		100 Pieces - Bulk		\$608.35



Flush Trim - Double End

PART	CUTTING LENGTH	SHANK DIAMETER	OVERALL LENGTH	PRICE
SC28A	1/4	1/4	2	\$13.14



Dado Trim - Small Pilot for Dado

PART	CUTTING LENGTH	SHANK DIAMETER	OVERALL LENGTH	PRICE
SC28C	1/4	1/4	1-1/2	\$7.93
SC28C-BLK		20 Pieces - Bulk		\$124.65
		50 Pieces - Bulk		\$293.50
		100 Pieces - Bulk		\$551.50

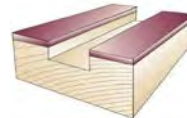

7° Bevel Trim

PART	CUTTING LENGTH	SHANK DIAMETER	OVERALL LENGTH	PRICE
SC29	1/4	1/4	1-1/2	\$8.76
SC29-BLK		20 Pieces - Bulk		\$137.95
		50 Pieces - Bulk		\$324.25
		100 Pieces - Bulk		\$608.35



7° Bevel Trim - Double End

PART	CUTTING LENGTH	SHANK DIAMETER	OVERALL LENGTH	PRICE
SC29A	1/4	1/4	2	\$14.18



Flush and 7° Bevel Trim - Without Pilot

PART	CUTTING LENGTH	SHANK DIAMETER	OVERALL LENGTH	PRICE
SC30	3/8	1/4	1-1/2	\$9.59



WHITESIDE MACHINE

Hole and Flush Trim

PART	CUTTING LENGTH	SHANK DIAMETER	OVERALL LENGTH	PRICE
SC31	3/8	1/4	2	\$10.64



Solid Carbide Fiberglass Bit

PART	CUTTING DIAMETER	CUTTING LENGTH	SHANK DIA.	OVERALL LENGTH	PRICE
SC90	1/4	3/4	1/4	2-1/2	\$17.52
SC90V	1/4	3/4	1/4	2-1/2	\$18.35
SC91V NEW	1/4	1	1/4	3	\$22.52

SC90 has a flat plunge point while the SC90V has a vee plunge point. SC90V & SC91V are supplied with vee plunge point



Rip and Slotting

PART	CUTTING LENGTH	SHANK DIAMETER	OVERALL LENGTH	PRICE
SC32	3/8	1/4	1-1/2	\$10.43



Screw Slot Bits

Use these **solid carbide** bits with a plunge router to cut slots for #8 screws. Screw slots allow for the seasonal movement of larger wooden parts such as table tops. These bits will also cut up to a 7/16" deep recess for the screw head.

PART	STYLE	LARGE DIA.	CUTTING LENGTH	OVERALL LENGTH	PRICE
SC100	82° C'sink	7/16"	15/16"	3"	\$32.54
SC102	Flat C'bore	1/2"	15/16"	3"	\$32.54



Flat Bottom Veining - 1/4" Shank Double Flute

PART	CUTTING LENGTH	SHANK DIAMETER	OVERALL LENGTH	PRICE
SC062	1/16	3/16	1-1/2	\$12.52
SC33	1/8	1/4	2	\$11.89
SC156	5/32	3/8	1-1/2	\$12.18
SC34	3/16	3/8	2	\$12.68
SC35	1/4	1/2	2	\$13.97



CNC Straight Cut Router Bits

1/2 SHANK - SINGLE FLUTE

PART	CUTTING DIAMETER	CUTTING LENGTH	OVERALL LENGTH	PRICE
C1052	1/2	1-1/4	2-7/8	\$16.24
C1055	1/2	2	4-1/8	\$20.03

1/2 SHANK - DOUBLE FLUTE

PART	CUTTING DIAMETER	CUTTING LENGTH	OVERALL LENGTH	PRICE
C1067	1/2	1-1/4	2-7/8	\$17.17
C1069	1/2	1-1/2	3-1/8	\$18.89
C1072	1/2	2	4-1/8	\$26.70

5/8 SHANK - DOUBLE FLUTE

PART	CUTTING DIAMETER	CUTTING LENGTH	OVERALL LENGTH	PRICE
C6310	5/8	1-1/4	3	\$24.62
C6320	5/8	2	4	\$30.04

3/4 SHANK - DOUBLE FLUTE

PART	CUTTING DIAMETER	CUTTING LENGTH	OVERALL LENGTH	PRICE
C7512	3/4	1-1/4	3	\$24.62
C7515	3/4	1-1/2	3-1/4	\$26.70
C7520	3/4	2	4	\$31.70
C7520F	3/4	2	4	\$40.05
C7520V	3/4	2	4	\$42.55
C7525	3/4	2-1/2	4-1/2	\$35.04
C7525F	3/4	2-1/2	4-1/2	\$43.38
C8820V	7/8	2	4	\$35.04
C1108	1	1-1/2	3-1/4	\$29.20
C1109	1	2	4-1/4	\$36.71

F - Supplied with Carbide Flat Bottom Boring Point.

V - Supplied with Carbide Vee Bottom Boring Point.

CNC Tools are designed to meet the severe applications of CNC routing.

These tools offer superior performance over standard straight flute bits at the high feed rates commonly found on CNC routers. They also provide an economical alternative to the more expensive spiral bits. For the ultimate in CNC routing, choose from Whiteside's wide selection of Solid Carbide Spiral Bits.

Use on CNC Routers only.



Round Bottom Veining - 1/4" Shank Double Flute

PART	RADIUS	CUTTING DIA.	CUTTING LENGTH	OVERALL LENGTH	PRICE
SC39	1/16	1/8	1/4	2	\$14.52
SC40	3/32	3/16	3/8	2	\$14.10
SC41	1/8	1/4	1/2	2	\$13.87

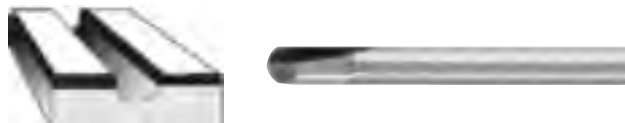

Carving Liner

PART	POINT LENGTH	SHANK DIAMETER	OVERALL LENGTH	PRICE
SC50	5/8	1/4	2-1/2	\$20.86



WHITESIDE MACHINE

Straight Bits

1/4 SHANK - Single Flute

PART	CUT DIA.	CUT LENGTH	OVERALL LENGTH	SPECIAL USE	PRICE
1004	1/4	3/4	2-1/4	--	\$9.97
1005	1/4	1	2-1/2	--	\$10.28
1007	1/4	1	3-1/8	--	\$10.52
1007A	1/4	1	3-1/4	--	\$10.27
1008	9/32	3/4	2-1/4	--	\$11.14

1/4 SHANK - Double Flute

PART	CUT DIA.	CUT LENGTH	OVERALL LENGTH	SPECIAL USE	PRICE
1012	1/4	1/2	2	--	\$11.85
1013	1/4	3/4	2-1/4	Incra™	\$11.68
1014	1/4	1	2-1/2	--	\$12.10
1016	1/4	1	3	--	\$12.93
1016-01	1/4	1	3-1/4	Air Router	\$13.68
1018	9/32	1	3	--	\$13.68
1019	5/16	1	2-1/2	OmniJig® 43300	\$13.01
1020	5/16	1	2-3/4	Leigh 140	\$13.45
1020X8*	5/16	1	2-3/4	Leigh 140-8mm shank	\$15.84
1021	3/8	3/4	2-1/4	--	\$13.01
1022	3/8	1	2-1/2	Incra™	\$13.68
1023	3/8	1-1/4	2-3/4	--	\$15.82
1023A	13/32	1	2-1/2	--	\$14.52
1024	7/16	1	2-1/2	--	\$14.93
1024A	31/64	3/4	2-1/4	Undersize Plywood Dado	\$15.02
1025	1/2	3/4	2-1/4	--	\$13.35
1026	1/2	1	2-1/2	OmniJig® 43318	\$14.18
1027	9/16	3/4	2-1/4	--	\$15.02
1027A	19/32	3/4	2-1/4	Undersize Plywood Dado	\$15.02
1028	5/8	3/4	2-1/8	--	\$14.99
1029	11/16	3/4	2-1/8	--	\$17.15
1029A	23/32	3/4	2-1/8	Undersize Plywood Dado	\$17.15
1030	3/4	3/4	2-1/8	--	\$15.65
1031	3/4	1	2-5/8	--	\$17.44
1033	1	3/4	2-1/8	--	\$19.61
1303	1-1/4	1/2	2-1/8	Mortising	\$22.40

3/8 SHANK - SINGLE FLUTE

PART	CUT DIA.	CUT LENGTH	OVERALL LENGTH	SPECIAL USE	PRICE
1035	3/8	1	2-5/8	--	\$12.47
1036	3/8	1-1/4	2-7/8	--	\$14.69

3/8 SHANK - DOUBLE FLUTE

PART	CUT DIA.	CUT LENGTH	OVERALL LENGTH	SPECIAL USE	PRICE
1039	3/8	1	2-5/8	--	\$14.40
1040	3/8	1-1/4	2-7/8	--	\$15.35
1041	3/8	1-1/4	3-5/8	--	\$15.90
1043	1/2	1	2-1/2	--	\$15.27
1045	7/8	1	2-1/2	--	\$20.03

1/2 SHANK - SINGLE FLUTE

PART	CUT DIA.	CUT LENGTH	OVERALL LENGTH	SPECIAL USE	PRICE
1049	3/8	1	2-5/8	--	\$12.47
1050	3/8	1-1/4	2-7/8	--	\$13.67
1051	1/2	3/4	2-3/8	Midwest Machine	\$12.10
1052	1/2	1-1/4	2-7/8	--	\$12.72
1054	1/2	1-1/2	3-1/8	--	\$13.56
1055	1/2	2	4-1/8	--	\$16.27
1055A	1/2	2-1/2	4-3/8	--	\$20.71

1/2 SHANK - DOUBLE FLUTE

PART	CUT DIA.	CUT LENGTH	OVERALL LENGTH	SPECIAL USE	PRICE
1058	1/4	3/4	2-3/8	Incra™	\$14.77
1059	9/32	3/4	2-3/8	--	\$14.77
1060	5/16	1	2-5/8	--	\$15.22
1061	3/8	3/4	2-3/8	--	\$13.06
1062	3/8	1	2-5/8	Incra™	\$14.40
1063	3/8	1-1/4	2-7/8	--	\$15.82
1064	13/32	3/4	2-1/2	--	\$14.52
1065	7/16	1-1/4	2-7/8	--	\$14.70
1065L	7/16	1-1/4	3-1/4	Leigh 150	\$15.62
1065A	31/64	1	2-5/8	Undersize Plywood Dado	\$13.68
1066	1/2	1	2-5/8	--	\$13.68
1067	1/2	1-1/4	2-7/8	Leigh 160	\$14.10
1067F	1/2	1-1/4	2-7/8	Carbide Boring Point	\$20.57
1069	1/2	1-1/2	3-1/8	--	\$15.19
1069DS	1/2	1-1/2	3-1/8	Down Shear	\$18.22
1070	1/2	1-1/2	4-1/8	--	\$17.14
1071	1/2	2	3-1/2	--	\$20.93
1072	1/2	2	4-1/8	--	\$21.43
1073	1/2	2-1/2	4-3/8	--	\$27.80
1073-01*	1/2	2-1/2	5-1/2	--	\$30.04
1074	17/32	1-1/4	2-7/8	--	\$16.64
1075	9/16	1-1/4	3	--	\$15.52
1075A	19/32	3/4	2-1/4	Undersize Plywood Dado	\$16.32
1076	5/8	1	2-1/2	--	\$14.85
1076F	5/8	1	2-1/2	Carbide Boring Point	\$22.03
1077	5/8	1-1/4	3	--	\$15.52
1078	5/8	1-1/2	3	--	\$16.64
1079	5/8	2	4	--	\$26.10
1080	21/32	1-1/4	3	--	\$18.62
1082	11/16	1	2-1/2	--	\$16.64
1083	11/16	1-1/4	3	--	\$17.44
1083A	23/32	1	2-1/2	Undersize Plywood Dado	\$16.64
1302A	3/4	5/8	2-1/4	Mortising	\$16.19
1084	3/4	1	2-3/4	--	\$16.19
1085	3/4	1-1/4	3	--	\$16.64
1085F	3/4	1-1/4	3	Carbide Boring Point	\$23.69
1086	3/4	1-1/2	3-1/4	--	\$18.86
1087	3/4	2	3-5/8	--	\$26.03
1088	25/32	1-1/4	3	--	\$17.86
1090	13/16	1-1/4	3	--	\$18.77
1091	7/8	1-1/4	3	--	\$18.77
1092	15/16	1-1/4	3	--	\$21.69
1093	1	1-1/4	3	--	\$20.79
1093F	1	1-1/4	3	Carbide Boring Point	\$27.80
1094	1	1-1/2	3	--	\$22.31
1095	1	2	3-3/4	--	\$30.45
1096	1-1/8	1-1/2	3	--	\$27.74
1304	1-1/4	1/2	2-1/8	Mortising	\$19.40
1097	1-1/4	1-1/2	3	--	\$26.70
1098	1-3/8	1-1/4	3	--	\$31.29
1099	1-1/2	1-1/4	3	--	\$33.04
1100	1-3/4	1-1/4	3	--	\$47.56
1101	2	1-1/4	3	--	\$50.81

1/4" Shank



3/8" Shank



1/2" Shank



WHITESIDE MACHINE

Straight Cut - Left Hand

* CAUTION: LEFT HAND ROTATION

1/4" SHANK - DOUBLE FLUTE

PART	CUTTING DIAMETER	CUTTING LENGTH	OVERALL LENGTH	PRICE
1014LH	1/4	1	2-1/2	\$20.49

1/2" SHANK - DOuBLE FLuTE

PART	CUTTING DIAMETER	CUTTING LENGTH	OVERALL LENGTH	PRICE
1062LH	3/8	1	2-5/8	\$25.03
1066LH	1/2	1	2-5/8	\$27.11
1069LH	1/2	1 1/2	3-1/8	\$32.12
1072LH	1/2	2	4-1/8	\$38.38
1085LH	3/4	1-1/4	3	\$31.70

3/4" SHANK - DOuBLE FLuTE

PART	CUTTING DIAMETER	CUTTING LENGTH	OVERALL LENGTH	PRICE
1105LH	3/4	2	5	\$36.71
1126LH*	3/4	2-1/2	5	\$40.05
1128LH*	3/4	2-1/2	5-1/2	\$41.72

* Recommended for Topmaster machines.



Straight Cut - Cabinet Dado Bits

1/4" SHANK - DOuBLE FLuTE

PART	CUT DIA.	PLYWOOD SIZE	CUT LENGTH	OVERALL LENGTH	PRICE
SC13*	7/32	1/4" / 5.5mm	3/4	2	\$14.60
1024A	31/64	1/2	3/4	2-1/4	\$15.02
1027A	19/32	5/8	3/4	2-1/4	\$15.02
1029A	23/32	3/4	3/4	2-1/4	\$17.15

1/2" SHANK - DOuBLE FLuTE

PART	CUT DIA.	PLYWOOD SIZE	CUT LENGTH	OVERALL LENGTH	PRICE
SC218*	7/32	1/4" / 5.5mm	3/4	2-3/4	\$20.86
SC235*	15/64	15/64" / 6mm	3/4	2-3/4	\$20.86
1065A	31/64	1/2	1	2-5/8	\$13.68
1075A	19/32	5/8	3/4	2-1/4	\$16.32
1083A	23/32	3/4	1	2-1/2	\$16.64

* Solid Carbide

Bits are specialized for Undersized Plywood.



Straight Cut with Boring Point 1/2" Shank

PART	CUTTING DIAMETER	CUTTING LENGTH	OVERALL LENGTH	PRICE
1067F	1/2	1-1/4	2-7/8	\$20.57
1076F	5/8	1	2-1/2	\$22.03
1085F	3/4	1-1/4	3	\$23.69
1093F	1	1-1/4	3	\$27.80

These tools are the same as Whiteside's standard straight with an added carbide flat bottom boring point for improved plunge routing.



END VIEW OF BORING POINT

Template Bits with Ball Bearing Guide

1/4" SHANK

PART	CUT DIA.	CUT LENGTH	OVERALL LENGTH	BEARING	PRICE
3000A*	1/2	1/8	1-3/4	B9	\$18.77
3000*	1/2	1/4	1-7/8	B9	\$17.94
3001 NEW	1/2	1/2	2	B9	\$18.77
3002	1/2	3/4	2-1/4	B9	\$19.61
3004	1/2	1	2-1/2	B9	\$20.19
3006*	5/8	1/4	1-3/4	B6	\$19.61
K41	5/8	1/2	2-1/4	B6	\$25.03
K43	5/8	3/4	2-1/2	B6	\$26.70
3008	5/8	1	2-1/2	B6	\$24.62
3010*	3/4	1/4	1-3/4	B4	\$19.61
3012	3/4	3/4	2-3/8	B4	\$23.78
3014	3/4	1	2-5/8	B4	\$24.99

3/8" SHANK

PART	CUT DIA.	CUT LENGTH	OVERALL LENGTH	BEARING	PRICE
3015	7/8	1	2-5/8	B12	\$31.70

1/2" SHANK

PART	CUT DIA.	CUT LENGTH	OVERALL LENGTH	BEARING	PRICE
3016	1-1/8	1	3	B11	\$31.70
3018	1-1/8	1-1/2	3-1/2	B11	\$35.46
3019	1-1/8	2	4	B11	\$45.89
3020**	3/4	1	2-3/4	B19	\$26.70
3021**	3/4	1-1/4	3	B19	\$28.37
3022**	3/4	1-1/2	3-1/4	B19	\$31.29
3022A NEW	7/8	1-1/2	3-1/2	B13	\$31.29
3023**	3/4	2	3-5/8	B19	\$38.38

* Dado clean out bits. These bits are used to square the bottom of dado cuts made on a table saw.

** Whiteside recommends the 1-1/8" diameter tools in the 1/2" shank whenever possible due to the fragile nature of the B19 bearing.



WHITESIDE MACHINE

Template Bits with Oversize Bearings 1/4" Shank

PART	CUT DIA.	CUT LENGTH	OVERALL LENGTH	BEARING DIA.	BEARING	PRICE
3025*	5/16	3/4	2-3/4	1/2	B9	\$20.03
3028**	1/2	1/4	1-7/8	3/4	B4	\$19.61
3032***	9/16	3/4	2-1/4	5/8	B6	\$20.86

* For Porter-Cable Morten™, Mortise and Tenon Jig and Omnijig® templates.

** For Hinge-Mate™ II Template.

*** Keller Joint Bit.



Staggertooth Bits - Straight Flute

1/4" SHANK

PART	CUTTING DIAMETER	CUTTING LENGTH	OVERALL LENGTH	PRICE
1200	1/4	1-1/4	3-1/2	\$15.02

1/2" SHANK

PART	CUTTING DIAMETER	CUTTING LENGTH	OVERALL LENGTH	PRICE
1201	3/8	1-1/2	3-1/8	\$16.85
1202	1/2	1-1/2	3-1/8	\$16.85
1203	1/2	2-1/8	4	\$19.61
1205	1/2	2-5/8	5-1/2	\$45.36



Up and Down Staggertooth Bits Opposite Shear (Compression)

PART	CUT DIA.	CUT LENGTH	SHANK DIA.	OVERALL LENGTH	PRICE
1250	1/2	1-1/2	1/2	3-1/2	\$30.04
1252	1/2	2	1/2	4	\$32.54
1260	3/4	2	5/8	4	\$43.38
1270	3/4	2	1/4	4	\$43.38



Mortise Bits

PART	CUT DIA.	CUT LENGTH	SHANK DIA.	OVERALL LENGTH	PRICE
1300	1/2	3/4	1/4	2-1/8	\$13.73
1301	5/8	3/4	1/4	2-1/8	\$15.32
1302	3/4	3/4	1/4	2-1/8	\$15.90
1303	1-1/4	1/2	1/4	2-1/8	\$22.40
1302A	3/4	5/8	1/2	2-1/4	\$16.19
1304	1-1/4	1/2	1/2	2-1/8	\$19.40

If you need a square corner on your mortise, use Whiteside's Square Corner Chisel.



1302A



Screw Type Helix with Downshear Cutter Only - Double Flute

PART	CUTTING DIA. FRACTIONAL	CUTTING DIA. DECIMAL	CUTTING LENGTH	OVERALL LENGTH	PRICE
13-500	1/2	.500	5/8	7/8	\$19.23
13-515	33/64	.515	5/8	7/8	\$19.23
13-531	17/32	.531	5/8	7/8	\$19.23
13-562	9/16	.562	5/8	7/8	\$19.23
13-625	5/8	.625	5/8	7/8	\$19.23
13-640	41/64	.640	5/8	7/8	\$19.23
13-656	21/32	.656	5/8	7/8	\$20.19
13-687	11/16	.687	5/8	7/8	\$20.19
13-719	23/32	.719	5/8	7/8	\$20.19
13-750	3/4	.750	5/8	7/8	\$20.19
13-765	49/64	.765	5/8	7/8	\$20.19
13-781	25/32	.781	5/8	7/8	\$20.19
13-812	13/16	.812	5/8	7/8	\$20.19
13-875	7/8	.875	5/8	7/8	\$20.19
13-937	15/16	.937	5/8	7/8	\$21.86
13-1000	1	1.000	1/2	1/2	\$21.86
13-1125	1-1/8	1.125	1/2	1/2	\$21.86
13-1250	1-1/4	1.250	1/2	1/2	\$21.86
13-1250A*	1-1/4	1.250	1/2	1/2	\$21.86

* 13-1250A is supplied with 5/16-24 threads.

All others supplied with 1/4-28 threads.

Special Cutting Diameters Available by Special Order.



Helix Mortise Arbors

PART	SHANK DIAMETER	THREAD	OVERALL LENGTH	PRICE
HMA-1/4	1/4	1/4-28	1-3/4	\$4.17
HMA-1/2	1/2	1/4-28	1-3/4	\$4.17
HMA-1/4A*	1/4	5/16-24	1-3/4	\$4.17
HMA-1/2A*	1/2	5/16-24	1-3/4	\$4.17

* Fits 13-1250A only

* Used with above Screw Helix Cutters



Bowl and Tray Bits

PART	RADIUS	CUT DIA.	CUT LENGTH	SHANK DIA.	OVERALL LENGTH	PRICE
1370	1/8	7/16	5/16	1/4	2-1/8	\$20.03
1372	1/4	3/4	5/8	1/4	2-3/8	\$20.86
1372B*	1/4	3/4	5/8	1/4	2-3/8	\$24.62
1374	1/4	3/4	5/8	1/2	2-3/8	\$20.86
1376	1/4	1-1/4	1/2	1/2	2-1/4	\$24.20
1376B*	1/4	1-1/4	1/2	1/2	2-1/4	\$30.04

* Supplied with Bearing on Shank for Pattern Template Routing.



WHITESIDE MACHINE

Round Nose (Core Box)

Caution: Cut Diameter is double the radius

1/4" SHANK

PART	RADIUS	CUT DIA.	CUT LENGTH	OVERALL LENGTH	PRICE
SC39*	1/16	1/8	1/4	2	\$14.52
SC40*	3/32	3/16	3/8	2	\$14.10
SC41*	1/8	1/4	1/2	2	\$13.87
1403	3/16	3/8	1/2	2	\$16.25
1404	1/4	1/2	5/8	2-1/4	\$19.58
1405	5/16	5/8	3/8	2	\$20.25
1406	3/8	3/4	7/16	2	\$20.64

1/2" SHANK

PART	RADIUS	CUT DIA.	CUT LENGTH	OVERALL LENGTH	PRICE
1407	3/16	3/8	1	2-5/8	\$22.49
1408	1/4	1/2	1-1/4	2-7/8	\$23.73
1410	5/16	5/8	1-1/4	2-7/8	\$25.86
1411	3/8	3/4	1-1/4	2-7/8	\$29.62
1412	7/16	7/8	1-1/4	2-7/8	\$37.55
1413	1/2	1	1-1/4	2-7/8	\$38.38
1414	5/8	1-1/4	1-1/4	3	\$41.72
1415	3/4	1-1/2	1-1/4	3	\$54.23
1416	7/8	1-3/4	1-1/4	3	\$78.43
1417	1	2	1-1/4	3	\$82.60

3/4" SHANK

PART	RADIUS	CUT DIA.	CUT LENGTH	OVERALL LENGTH	PRICE
1420	3/8	3/4	2	4	\$68.42

* Solid Carbide



Round Nose with Bearing Guide 1/4" Shank

PART	RADIUS	CUT DIA.	CUT BEARING LENGTH	PRICE
1404B	1/4	1/2	5/8	B9 \$24.86
1405B	5/16	5/8	3/8	B6 \$24.86
1406B	3/8	3/4	7/16	B4 \$24.86

The addition of a shank mounted bearing extends the use of our round nose bits in lettering, veining, or decorative cuts when following a template.

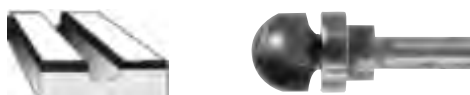

Half Round (Bull Nose)

1/4" SHANK

PART	(R) RADIUS	(B) OPENING OF CUTTER	(C) CUTTING LENGTH	LARGE DIA.	PRICE
1425	3/32	3/16	1/2	3/4	\$25.03
1426	1/8	1/4	9/16	7/8	\$25.03
1427	3/16	3/8	7/8	1	\$30.04
1428	1/4	1/2	1	1-1/8	\$38.38

1/2" SHANK

PART	(R) RADIUS	(B) OPENING OF CUTTER	(C) CUTTING LENGTH	LARGE DIA.	PRICE
1429	3/32	3/16	1/2	3/4	\$25.03
1430	1/8	1/4	9/16	7/8	\$25.03
1431	3/16	3/8	7/8	1	\$29.20
1432	1/4	1/2	1	1-1/8	\$37.55
1432A	5/16	5/8	1	1-1/4	\$46.72
1433	3/8	3/4	1-1/4	1-5/8	\$56.73
1433A	7/16	7/8	1-1/2	1-7/8	\$62.57
1434	1/2	1	1-1/2	1-15/16	\$62.57
1434A	9/16	1-1/8	1-1/2	1-15/16	\$75.09
1435	5/8	1-1/4	1-3/4	2-3/16	\$75.09
1436	3/4	1-1/2	1-7/8	2-7/16	\$116.81

Note: Large Diameter - Opening of Cutter = Small Diameter.

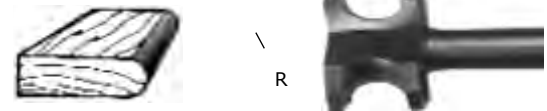

Plunge Cut Hand Grip - 1/2" Shank

PART	(A) BEAD OPENING	(B) BEAD DEPTH	CUTTING LENGTH	OVERALL LENGTH	PRICE
1440	7/8	1/4	1 3/8	3-1/2A	\$111.11

Bead Depth denotes bearing (B11) on shank for Pattern Template Routing.

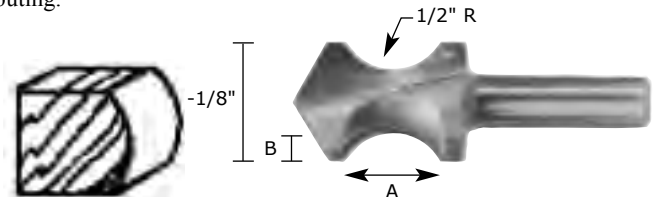

Oval Edge (Half Bull Nose) 1/2" Shank

PART	(A) BEAD OPENING	(B) BEAD DEPTH	CUTTING LENGTH	LARGE DIA.	PRICE
1470 NEW	7/8	5/32	1-1/4	13/16	\$111.11
1474	1/2	1/8	1	3/4	\$27.11
1476	3/4	3/16	1-1/4	1	\$35.46
1478	1	3/16	1-1/4	1	\$41.72
1480	1-1/2	1/4	1-3/4	1-1/4	\$51.73

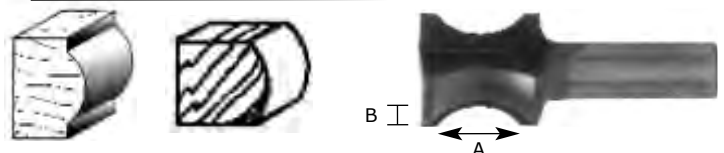

WHITESIDE MACHINE

V Groove - 90° Included Angle

1/4" SHANK

PART	CUTTING DIAMETER	POINT LENGTH	OVERALL LENGTH	PRICE
1500*	1/4	1/8	1-1/2	\$12.68
1501	3/8	3/16	1-7/8	\$14.97
1502	1/2	1/4	1-7/8	\$17.52

1/2" SHANK

PART	CUTTING DIAMETER	POINT LENGTH	OVERALL LENGTH	PRICE
1503	1/2	1/4	2	\$18.35
1504	3/4	3/8	2-1/4	\$34.54
1506	1	1/2	2-1/2	\$38.38
1508	1-1/2	3/4	2-5/8	\$54.23

* Solid Carbide

Not for Miter Folding

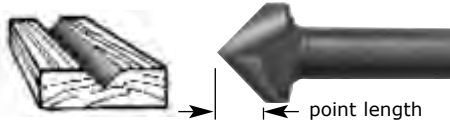

V Groove - 60° Included Angle

1/4" SHANK

PART	CUTTING DIAMETER	POINT LENGTH	OVERALL LENGTH	PRICE
1540*	1/4	7/32	1-1/2	\$12.68
1541*~	1/4	7/32	2	\$15.19
1550	1/2	7/16	2	\$18.35

1/2" SHANK

PART	CUTTING DIAMETER	POINT LENGTH	OVERALL LENGTH	PRICE
1560	1/2	7/16	2-1/4	\$19.19

* Solid Carbide

~ 1541 features three flutes for improved veining.

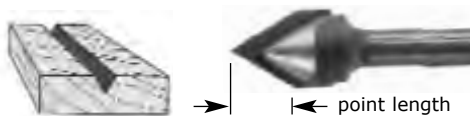

Point Cutting Roundover Decorative Trimming and Lettering

1/4" SHANK

PART	RADIUS	CUT DIA.	CUT LENGTH	OVERALL LENGTH	PRICE
1568	1/8	1/4	1/4	2	\$21.63
1570	3/16	3/8	3/8	2	\$17.52
1572	1/4	1/2	1/2	2	\$18.77
1574	3/8	3/4	5/8	2	\$23.78

1/2" SHANK

PART	RADIUS	CUT DIA.	CUT LENGTH	OVERALL LENGTH	PRICE
1580	3/8	3/4	5/8	2-1/4	\$23.78

Point cutting roundovers are not guaranteed against breakage.

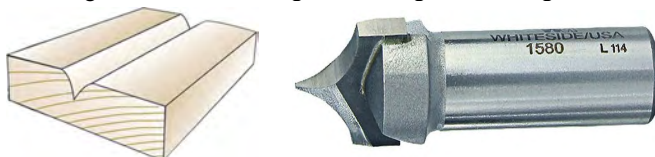

Panel Bits - Pilot Plunge Point

SINGLE FLUTE

PART	CUT DIA.	CUT LENGTH	SHANK DIA.	OVERALL LENGTH	PRICE
1700	1/4	3/4	1/4	2-5/8	\$9.98
1701	3/8	1	3/8	3-3/8	\$13.35
1702	1/2	1-1/4	1/2	4	\$13.35
1702A NEW	1/2	1-1/4	1/2	3-5/8	\$12.52

DOuBLE FLUTE

PART	CUT DIA.	CUT LENGTH	SHANK DIA.	OVERALL LENGTH	PRICE
1704	3/8	1	1/4	3-1/4	\$19.36
1705	3/8	1	3/8	3	\$19.36
1706	1/2	1-1/4	1/2	4	\$21.69



Staggertooth Panel Bit with Center Pilot - 1/2" Shank

PART	CUT DIA.	(A) CUT LENGTH	(B) FLUTE LENGTH	OVERALL LENGTH	PRICE
1726	1/2	2-3/4	1-1/8	4-1/4	\$33.38

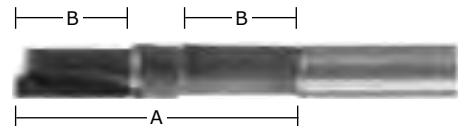

Cove Bits

1/4" SHANK

PART	RADIUS	LARGE DIA.	CUTTING LENGTH	BEARING NUMBER	PRICE
1800A	3/16	7/8	1/2	B3	\$21.69
1800	1/4	1	1/2	B3	\$21.69
1801	3/8	1 1/4	1/2	B3	\$23.78
1802	1/2	1 1/2	5/8	B3	\$26.70

1/2" SHANK

PART	RADIUS	LARGE DIA.	CUTTING LENGTH	BEARING NUMBER	PRICE
1803	1/4	1	1/2	B3	\$21.69
1804	3/8	1-1/4	1/2	B3	\$23.78
1805	1/2	1-1/2	5/8	B3	\$26.70
1806	5/8	1-3/4	3/4	B3	\$42.55
1807	3/4	2	7/8	B3	\$48.39
1810	1	2-1/2	1	B3	\$75.09



WHITESIDE MACHINE

Rabbet Bits

1/4" SHANK

PART	LARGE DIA.	CUT LENGTH	CUT DEPTH	BEARING NUMBER	PRICE
1900	1-1/4	1/2	3/8	B3	\$20.44
1951	1-3/8	1/2	1/2	B2	\$22.52

1/2" SHANK

PART	LARGE DIA.	CUT LENGTH	CUT DEPTH	BEARING NUMBER	PRICE
1901	1-1/4	1/2	3/8	B3	\$20.44
1954	1-3/8	1/2	1/2	B2	\$22.11
1959	1-7/8	1	3/4	B2	\$43.38

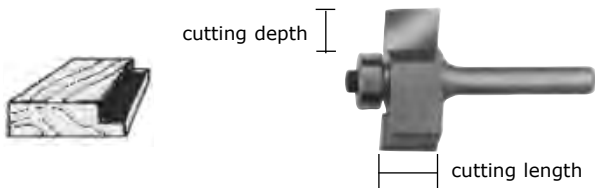

BB501 - Bearing Kit with Wrench. Increase the versatility of your Rabbeting Bits by simply changing the bearing size to vary your cutting depth. This set allows 1/4", 5/16", 3/8", and 7/16" cutting depth on all 1-1/4" bits or 3/8", 7/16", 1/2", and 9/16" cutting depth on all 1-1/2" bits. **Price: \$12.52**

Slotting and Rabbeting

1/4" SHANK

PART	LARGE DIA.	(A) CUTTING LENGTH	(B) CUTTING DEPTH	OVERALL LENGTH	PRICE
1904	1-1/4	1/8	3/8	2	\$20.03
1908*	1-1/2	5/32	1/2	1-3/4	\$17.52
1912	1-1/4	1/4	3/8	2	\$18.77
1916	1-1/4	3/8	3/8	2	\$20.86
1920	1-1/2	1/2	1/2	2	\$22.94

1/2" SHANK

PART	LARGE DIA.	(A) CUTTING LENGTH	(B) CUTTING DEPTH	OVERALL LENGTH	PRICE
1906	1-1/4	1/8	3/8	2	\$20.03
1910*	1-1/2	5/32	1/2	2	\$17.52
1914	1-1/4	1/4	3/8	2	\$18.77
1918	1-1/4	3/8	3/8	2-1/8	\$20.86
1922	1-1/2	1/2	1/2	2-1/4	\$22.94
1924	1-1/4	3/4	3/8	2-1/2	\$25.86

* Proper size for biscuit joining.
B3 Bearing supplied

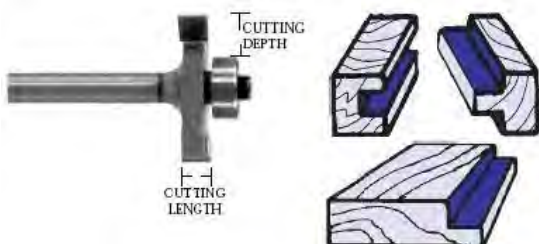

Biscuit Joining Kit

PART	DESCRIPTION	PRICE
1940	1/4" Shank Kit	\$27.11
1945	1/2" Shank Kit	\$27.11

This kit contains our 5/32" Rabbeting Bit with 1/2" B3 bearing for cutting slots to fit 20 Biscuits. Also includes alternate bearings B14 and B15 to cut slots for 0 and 10 Biscuits. Hex Wrench included.



Multi Rabbet Set

PART	LARGE DIA.	CUTTING LENGTH	DESCRIPTION	PRICE
1952	1-3/8	1/2	1/4" Shank Set	\$48.39
1955	1-3/8	1/2	1/2" Shank Set	\$48.39

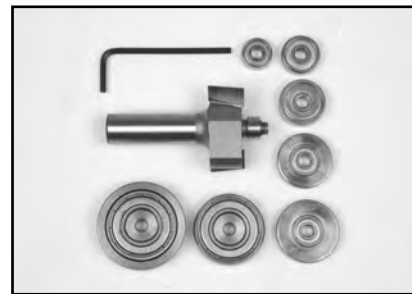

Change Your Rabbet depth by changing the bearing! Set Includes all eight bearings to make each of the cuts shown. Hex Wrench included

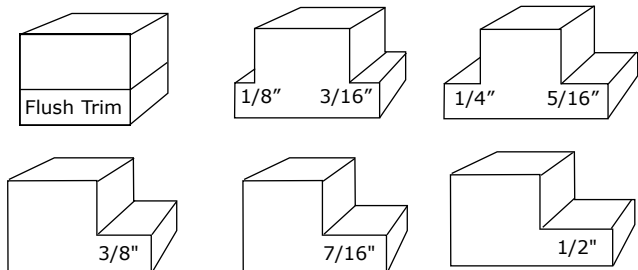

Deep Multi Rabbet Set

PART	LARGE DIA.	CUTTING LENGTH	DESCRIPTION	PRICE
1960	1-7/8	1	1/2" Shank Set	\$56.73

Our largest Rabbet Bit in a set with five bearings. Makes those extra deep Rabbet cuts as shown. Hex Wrench included.

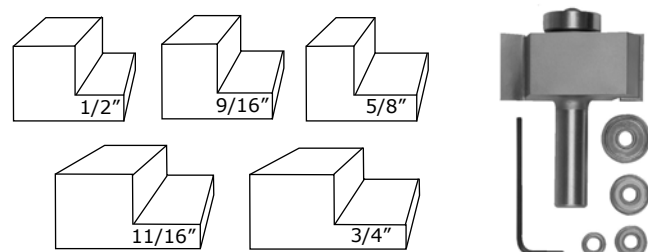

NOT ALL OF THE WHITESIDE WOOD SAMPLES ARE SHOWN ACTUAL SIZE - SEE INDIVIDUAL ITEMS FOR DETAILS

WHITESIDE MACHINE

Roundover Bits - Small Pilot - 1/4" Shank

PART	RADIUS	LARGE DIA.	CUT LENGTH	OVERALL LENGTH	PRICE
1978	1/16	3/8	7/16	2	\$20.86
1980	1/8	3/8	7/16	2	\$20.03
1982	1/4	5/8	1/2	2-1/8	\$20.44
1984	3/8	7/8	5/8	2-1/4	\$22.52

Extra Small Brass Pilot (5/32" dia.) allows these bits to roundover edges on finely detailed workpieces with intricate contours, tight confines, and narrow openings. These bits give professional results without all the tedious hand sanding. Carbide cutting edges far outlast comparable high speed steel bits.



Multi-Beading Sets for Extra Deep Beading

PART	RADIUS	LARGE DIA.	CUT LENGTH	OVERALL LENGTH	PRICE
2040B	1/4	1-1/4	1/2	2-3/8	\$31.70
2042B	3/8	1-1/2	5/8	2-1/2	\$35.67
2044B	1/2	1-3/4	3/4	2-5/8	\$37.55

Roundover and More! Conventional Beading cuts a shallow 1/16" bead. Expand your capabilities with these versatile sets. Deeper beads create a more pronounced edge on larger pieces. Includes all four bearings and Hex Key Wrench.

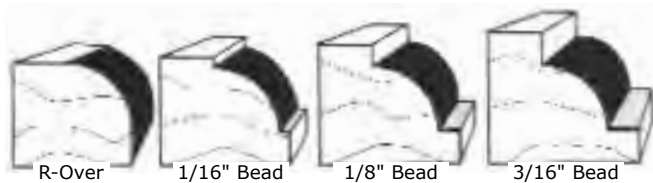

Roundover and Edge Trim (Long Nose) with Plunge Point - 1/2" Shank

PART	RADIUS	LARGE DIA.	SMALL DIA.	CUT LENGTH	OVERALL LENGTH	PRICE
2068*	3/16	1	1/2	13/16	2-5/8	\$45.05
2070**	3/16	1	1/2	1-5/16	3-1/8	\$61.74
2072*	1/4	1-1/8	1/2	13/16	2-5/8	\$54.23
2074**	1/4	1-1/8	1/2	1-5/16	3-1/4	\$70.08
2076*	3/8	1-3/8	1/2	13/16	2-3/4	\$60.07
2078**	3/8	1-3/8	1/2	1-5/16	3-1/4	\$73.42

* Edge Trim for 3/4 stock
 ** Edge Trim for 1 1/4 stock



Roundover with Ball Bearing Guide



Roundover

1/4" SHANK

ROUND OVER PART	RADIUS	LARGE DIAMETER	CUTTING LENGTH	PRICE
2000A	1/16	5/8	1/2	\$19.19
2000B	3/32	11/16	1/2	\$20.44
2000C	1/8	3/4	1/2	\$18.77
2000D	5/32	13/16	1/2	\$20.86
2000	3/16	7/8	1/2	\$19.61
2001	1/4	1	1/2	\$19.61
2002	5/16	1-1/8	1/2	\$21.69
2003	3/8	1-1/4	5/8	\$21.69
2004	1/2	1-1/2	3/4	\$26.70

1/2" SHANK

ROUND OVER PART	RADIUS	LARGE DIAMETER	CUTTING LENGTH	PRICE
2005C	1/8	3/4	1/2	\$18.77
2005	3/16	7/8	1/2	\$20.44
2006	1/4	1	1/2	\$19.61
2007	5/16	1-1/8	1/2	\$21.69
2008	3/8	1-1/4	5/8	\$21.69
2008A	7/16	1-3/8	5/8	\$29.20
2009	1/2	1-1/2	3/4	\$26.70
2009A	5/8	1-3/4	1	\$43.38
2009B	9/16	1-5/8	3/4	\$35.04
2010	3/4	2	1	\$47.56
2011	7/8	2-1/4	1-1/8	\$81.77
2012	1	2-1/2	1-5/16	\$91.54
2013	1-1/8	3	1-1/2	\$118.47
2014	1-1/4	3-1/4	1-3/4	\$123.48
2015	1-3/8	3-1/2	1-3/4	\$135.16
2016	1-1/2	3-3/4	1-7/8	\$135.16

Bearings:

Use B3 for Rounding Over; Use B2 for Beading; Use B4 for 2013 thru 2016

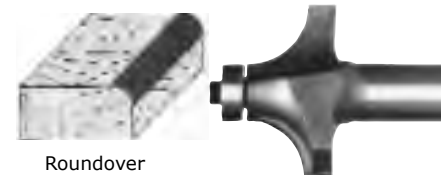

Roundover

Beading with Ball Bearing Guide



1/16 BEAD

1/4" SHANK

BEADING	RADIUS	LARGE DIAMETER	CUTTING LENGTH	PRICE
2100A	1/16	5/8	1/2	\$20.86
2000C	1/8	3/4	1/2	\$18.77
2000D	5/32	13/16	1/2	\$20.86
2100	3/16	7/8	1/2	\$20.86
2101	1/4	1	1/2	\$21.19
2102	5/16	1-1/8	1/2	\$23.36
2103	3/8	1-1/4	5/8	\$23.36
2104	1/2	1-1/2	3/4	\$28.37

Roundover with Ball Bearing Guide

1/2" SHANK

BEADING PART	RADIUS	LARGE DIAMETER	CUTTING LENGTH	PRICE
2105C	1/8	3/4	1/2	\$20.44
2105	3/16	7/8	1/2	\$22.52
2106	1/4	1	1/2	\$21.19
2107	5/16	1-1/8	1/2	\$23.36
2108	3/8	1-1/4	5/8	\$23.36
2109	1/2	1-1/2	5/8	\$28.37
2110	3/4	2	1	\$49.22

Bearings:

Use B3 for Rounding Over;

Use B2 for Beading



Double Toundover with Adjustable Cutting Length - 1/2" Shank

PART	RADIUS	LARGE DIAMETER	OVERALL LENGTH	PRICE
2160	1/8	1-1/8	3-3/4	\$46.72
2162	3/16	1-1/4	3-3/4	\$46.72
2164	1/4	1-3/8	3-3/4	\$46.72

Assemblies Sold with B5 Bearing for flush round over
 Use B20 Bearing for 1/16" Bead • Use B27 Bearing for 1/8" Bead
 Replacement Cutter Heads: Add RH to Part Number for cutter next to shank, Add LH to Part Number for end cutter. Example: 2160LH

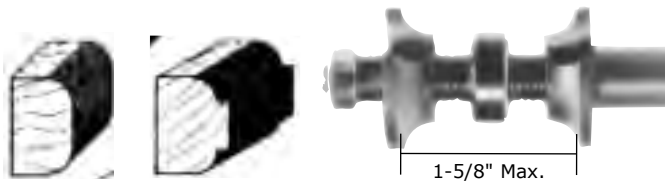

Roman Ogee

1/4" SHANK

PART	RADIUS	LARGE DIA.	CUTTING LENGTH	OVERALL LENGTH	PRICE
2200	5/32	1-1/8	9/16	2	\$28.79
2201	1/4	1-1/2	11/16	2-1/4	\$31.29

1/2" SHANK

PART	RADIUS	LARGE DIA.	CUTTING LENGTH	OVERALL LENGTH	PRICE
2202	5/32	1-1/8	9/16	2-1/4	\$28.79
2203	1/4	1-1/2	11/16	2-3/8	\$31.29
2210	3/8	2	1	2-3/4	\$46.72

Bearing Number: B3

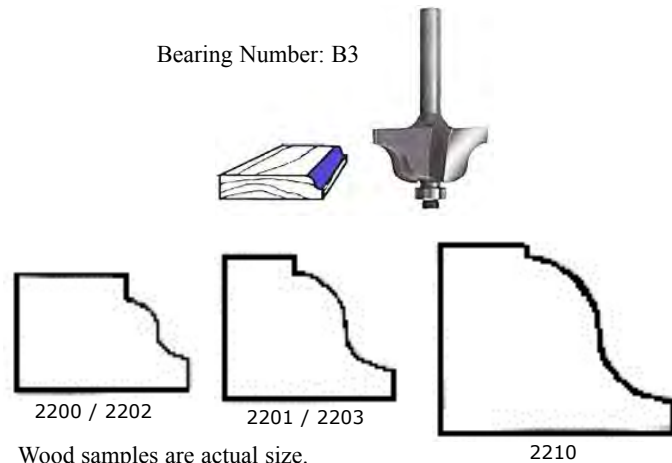

Plunge Roundover

1/4" SHANK

PART	(R) RADIUS	(A) LARGE DIA.	(B) SMALL DIA.	(C) PATTERN LENGTH	OVERALL LENGTH	PRICE
2050	1/8	3/8	1/8	1/4	1-3/4	\$18.35
2051	3/16	5/8	1/4	1/8	1-3/4	\$25.03
2052	1/4	3/4	1/4	3/8	1-7/8	\$28.37

1/2 SHANK

PART	(R) RADIUS	(A) LARGE DIA.	(B) SMALL DIA.	(C) PATTERN LENGTH	OVERALL LENGTH	PRICE
2055	1/4	3/4	1/4	1/4	2	\$28.37
2056	1/4	3/4	1/4	3/8	2	\$31.29
2057	3/8	1	1/4	5/16	2-1/8	\$35.67
2058	3/8	1	1/4	9/16	2-1/4	\$36.71
2060	1/2	1-3/8	3/8	3/4	2-1/2	\$43.38
2062	9/16	1-5/8	1/2	1	2-3/4	\$55.07
2064	5/8	1-3/4	1/2	1-1/16	3	\$60.07
2066	3/4	2	1/2	1-1/8	3	\$65.91

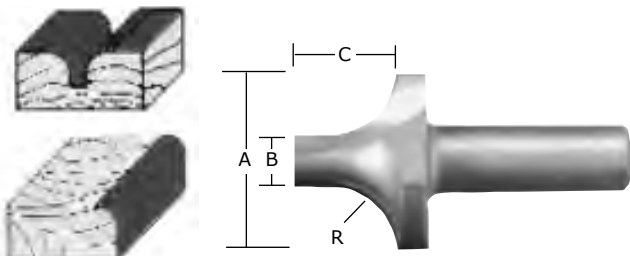

45° Chamfer

1/4" SHANK

PART	(a) DEGREE OF ANGLE	(B) CUTTING LENGTH	(C) CUTTING HEIGHT	OVERALL LENGTH	PRICE
*2292 NEW	45°	7/16	5/16	1-7/8	\$20.03
2302	45°	5/8	7/16	2	\$22.11

Bearing Number: B3 (Use B2 on #2292)

* 2292 has 1" large diameter for use in trim routers.

1/2" SHANK

PART	(a) DEGREE OF ANGLE	(B) CUTTING LENGTH	(C) CUTTING HEIGHT	OVERALL LENGTH	PRICE
2305	45°	5/8	7/16	2-1/4	\$22.11
2306	45°	1-1/16	3/4	2-1/2	\$34.42
2310	45°	1-1/2	1-1/16	3	\$65.08

Bearing Number: B3

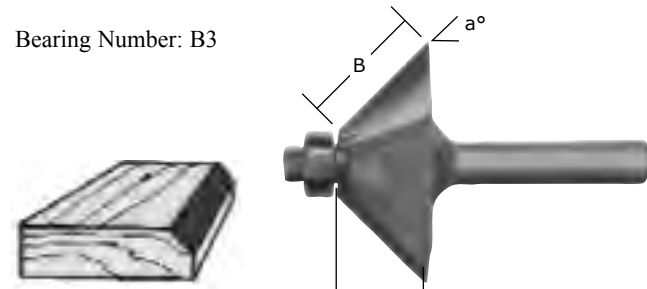

WHITESIDE MACHINE

Edge Bevel

1/4" SHANK

PART	(a) DEGREE OF ANGLE	(B) CUTTING LENGTH	(C) CUTTING HEIGHT	OVERALL LENGTH	PRICE
2298*	7°	3/8	3/8	2-1/8	\$16.27
2300	15°	1/2	1/2	2	\$17.02
2300A*	15°	1/4	1/4	2	\$15.44
2301	25°	9/16	1/2	2	\$17.69
2308	30°	7/8	3/4	2-3/4	\$28.37

1/2" SHANK

PART	(a) DEGREE OF ANGLE	(B) CUTTING LENGTH	(C) CUTTING HEIGHT	OVERALL LENGTH	PRICE
2325	15°	1	15/16	2-3/4	\$23.36
2307	22-1/2°	15/16	7/8	2-3/4	\$24.62
2309	30°	7/8	3/4	2-3/4	\$25.86

*Used on Laminate Trim

2308 / 2309 Used for six sided boxes

2307 Used for eight sided boxes

2325 Used for twelve sided boxes

Bearing Number: B3

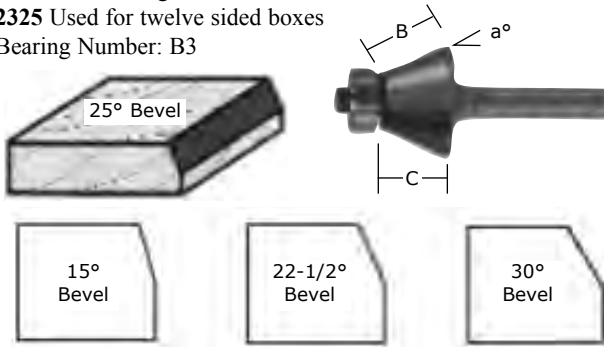

Flush Trim with Single Bearing Two Flute

1/4" SHANK

PART	CUT DIA.	CUT LENGTH	OVERALL LENGTH	BEARING NUMBER	PRICE
2400	3/8	1	2-1/8	B1	\$14.10
2401	3/8	1/2	2-1/8	B1	\$13.42
2402	1/2	1	2-1/2	B3	\$14.10
2403	1/2	1/2	2-1/8	B3	\$13.42

1/2" SHANK

PART	CUT DIA.	CUT LENGTH	OVERALL LENGTH	BEARING NUMBER	PRICE
2404A	3/8	1	3-1/8	B1	\$15.02
2405	1/2	1	3-1/4	B3	\$14.69
2406	1/2	1/2	2-3/4	B3	\$14.15
2407	1/2	1-1/2	3-5/8	B3	\$17.69
2408	1/2	2	4	B3	\$22.36
2410	3/4	1-1/4	3	B4	\$20.69
2415 NEW	7/8	1-1/2	3-1/2	B21	\$22.11



Flush Trim V-Groove

PART	CUT DIA.	CUT LENGTH	SHANK DIA.	OVERALL LENGTH	BEARING NUMBER	PRICE
2425	1/2	1	1/4	2-1/2	B3	\$18.53
2426	1/2	1	1/2	3-1/4	B3	\$18.53

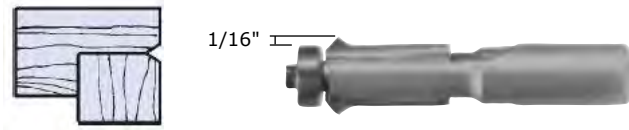

Overhang Trim Bit - 1/4" Shank

PART	OVERHANG	CUT DIA.	CUT LENGTH	BEARING NUMBER	PRICE
2468	1/16	3/8	1/2	B3	\$16.27
2470	1/8	3/8	1/2	B7	\$16.27



Flush Trim with Double Bearings Two Flute - 1/2" Shank

PART	CUT DIA.	CUT LENGTH	OVERALL LENGTH	BEARING NUMBER	PRICE
2457	1/2	1-1/2	3-7/8	B3	\$35.46
2458	1/2	2	4-1/4	B3	\$40.05



Flush Trim - Three Flute

1/4" SHANK

PART	CUT DIA.	CUT LENGTH	OVERALL LENGTH	BEARING NUMBER	PRICE
2500	1/2	1	2-1/2	B3	\$19.19
2501	1/2	1/2	2-1/8	B3	\$17.94

1/2" SHANK

PART	CUT DIA.	CUT LENGTH	OVERALL LENGTH	BEARING NUMBER	PRICE
2502	1/2	1	3-1/4	B3	\$19.61
2503	1/2	1/2	2-3/4	BB33	\$18.35
2504	1/2	1-1/2	3-5/8	BB33	\$23.63
2505	1/2	2	4	BB33	\$30.04



Flush Trim with Double Bearings Three Flute - 1/2" Shank

PART	CUT DIA.	CUT LENGTH	OVERALL LENGTH	BEARING NUMBER	PRICE
2554	1/2	1-1/2	3-7/8	B3	\$41.47
2555	1/2	2	4-1/4	B3	\$47.56



WHITESIDE MACHINE

Downshear Flush Trim - Two Flute

1/4" SHANK

PART	CUT DIA.	CUT LENGTH	OVERALL LENGTH	BEARING NUMBER	PRICE
2602	1/2	1	2-1/2	B3	\$17.52
2560	3/4	5/8	2-1/8	B4	\$21.69

1/2" SHANK

PART	CUT DIA.	CUT LENGTH	OVERALL LENGTH	BEARING NUMBER	PRICE
2605	1/2	1	3-1/4	B3	\$17.94
2570	3/4	1	3	B4	\$25.03
2575	3/4	1-1/2	3-1/2	B4	\$28.37
2580	3/4	2	4	B4	\$33.04

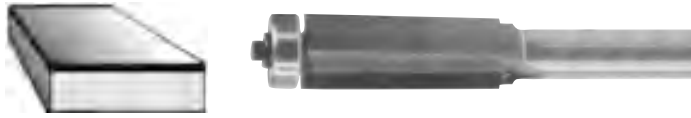

Combination Flush Trim

1/4" SHANK

PART	CUT DIA.	CUT LENGTH	OVERALL LENGTH	BEARING NUMBER	PRICE
2702	1/2	1	2-5/8	B3 & B9	\$20.86



2702

1/2" SHANK

PART	CUT DIA.	CUT LENGTH	OVERALL LENGTH	BEARING NUMBER	PRICE
2715	7/8	1-1/2	3-1/2	B3 & B211	\$28.37

Laminate Trim Bits with Ball Bearing Two Flute - 1/4" Shank

PART	BEVEL DEGREE	LARGE DIA.	CUTTING LENGTH	BEARING NUMBER	PRICE
2401	Flush	3/8	1/2	B1	\$13.42
2298	7°	9/16	7/16	B3	\$16.27
2300A	15°	5/8	1/4	B3	\$15.44
2301	25°	1	9/16	B3	\$17.69



Combination Flush or Bevel Laminate Trim 1/4" Shank

PART	CUTTING DIA.	DEGREE OF ANGLE	CUT LENGTH	OVERALL LENGTH	PRICE
2800	7/16	22-1/2°	1/2	1-1/8	\$13.85
2801	7/16	22-1/2°	1/2	1-7/8	\$13.85



Laminate Trimmers with Euro Square Bearings

1/4" SHANK

PART	CUT DIA.	CUT LENGTH	OVERALL LENGTH	BEARING NUMBER	PRICE
2640	1/2	1/4	1-5/8	B3SQ	\$18.77
2650	3/4	5/8	2-1/4	B8SQ	\$24.95

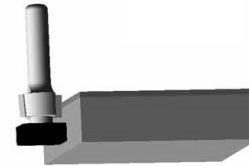

1/2" SHANK

PART	CUT DIA.	CUT LENGTH	OVERALL LENGTH	BEARING NUMBER	PRICE
2660	3/4	5/8	2-1/4	B8SQ	\$24.95

Here's a Square Deal! A quality Whiteside Trim Bit with the exclusive Euro Square Bearing. How does it work? The square bearing stops spinning as soon as it touches the workpiece. Then the side of the square slides along the workpiece edge. Compare this to a regular bearing that simply rolls along the edge - building up more glue and residue with every revolution. Plus, the square is made from non-stick Teflon, so it wipes clean easily and it won't mark your workpiece. If you cut laminates, you need to try this bit.

These bits are designed with a slight taper on the cutting diameter. This allows up or down adjustment to achieve an exact blend - even after resharpening.



WHITESIDE MACHINE

Round Over with Non-Marring Bearing 1/2" Shank

PART	MATERIAL THICKNESS	RADIUS	OVERALL LENGTH	BEARING NUMBER	PRICE
2006N	1/2	1/4	2-1/4	B3S	\$22.52
2009N	1	1/2	2-1/2	B3S	\$29.62
2010N	1-1/2	3/4	2-3/4	B3S	\$50.48

Supplied with Non-Marring Nylon Sleeved Bearing (Part B3S)



Rounding Under - 1/2" Shank

PART	MATERIAL THICKNESS	RADIUS	OVERALL LENGTH	BEARING NUMBER	PRICE
2030	1/2	1/4	2-3/4	B5	\$36.71
2034	1	1/2	3	B5	\$68.42
2036	1-1/2	3/4	3-3/8	B5	\$93.44

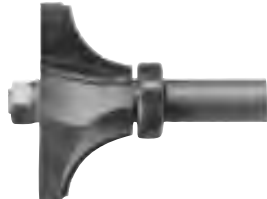

Rounding Over Undermount 1/2" Shank

PART	MATERIAL THICKNESS	DEGREE	OVERALL LENGTH	BEARING NUMBER	PRICE
2929	1/2	18°	3"	BB300	\$78.43
2930	3/4	18°	3-1/4	BB300	\$90.94

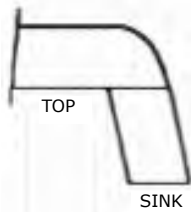

Bevel Undermount Bowl - 1/2" Shank

PART	MATERIAL THICKNESS	DEGREE	OVERALL LENGTH	BEARING NUMBER	PRICE
2944	1/2 - 3/4	12°	3	BB300	\$54.23

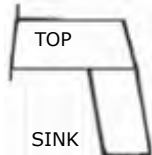

Solid Surface Bits 1/2" Shank

PART	MATERIAL THICKNESS	DEGREE	OVERALL LENGTH	BEARING NUMBER	PRICE
2910	1/2	10°	2-7/8"	BB300	\$81.11
2915	3/4	15°	2-7/8"	BB315	\$81.11
2918	1/2	18°	2-7/8"	BB318	\$81.11

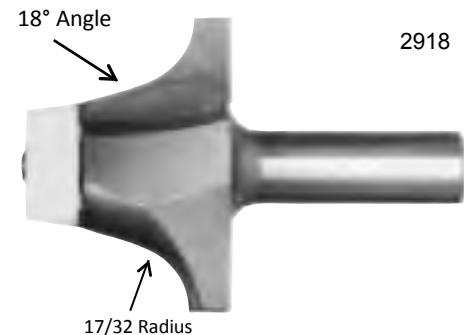
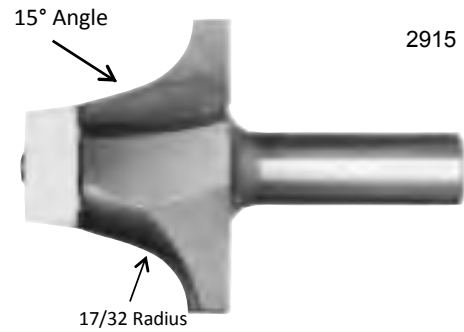
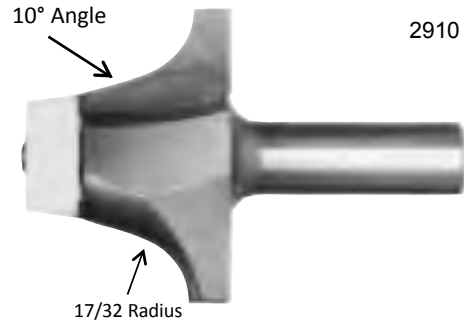

Dovetail - Single Flute

PART	CUT DIA	DEGREE	SHANK	OAL	PRICE
DT45-257	15mm	10°	12mm	2-23/64	\$50.47



* USED IN Powermatic and Other Dovetail Machines

WHITESIDE MACHINE COMPANY

Face Inlay - 1/2" Shank

PART	DIA.	CUTTING LENGTH	DEPTH	OVERALL LENGTH	BEARING	PRICE
2900	7/8	1/4	1/16	2-3/4	B4	\$24.98
2901	7/8	1/4	1/8	2-3/4	B6	\$24.98
2902	7/8	1/4	3/16	2-3/4	B9	\$24.98
2903	7/8	1/2	1/16	3	B4	\$24.98
2904	7/8	1/2	1/8	3	B6	\$24.98
2905	7/8	1/2	3/16	3	B9	\$24.98
2906	7/8	3/4	1/16	3-1/4	B4	\$24.98
2907	7/8	3/4	1/8	3-1/4	B6	\$24.98
2908	7/8	3/4	3/16	3-1/4	B9	\$24.98



Keyhole Bits

1/4" SHANK

PART	LARGE DIA.	SMALL DIA.	CUTTING LENGTH	OVERALL LENGTH	PRICE
3050	3/8	3/16	7/16	1-1/2	\$11.68
3052	1/2	5/16	7/16	1-1/2	\$15.02

1/2" SHANK

PART	CUT DIA.	CUT LENGTH	OVERALL LENGTH	BEARING NUMBER	PRICE
3051	3/8	3/16	7/16	2-1/8	\$13.35
3053	1/2	5/16	7/16	2-1/8	\$15.68

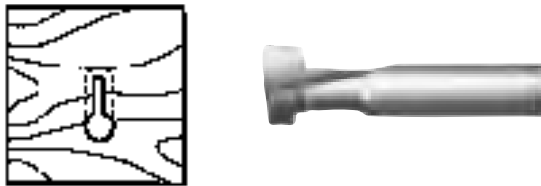

T-Slot Cutter - 1/2" Shank

PART	LARGE DIA.	SMALL DIA.	"A" LENGTH	"B" LENGTH	OVERALL LENGTH	PRICE
3070	1-1/16	3/8	5/16	1/2	2-3/8	\$45.89
3075	1-3/16	3/8	1/4	3/8	2-3/8	\$51.73

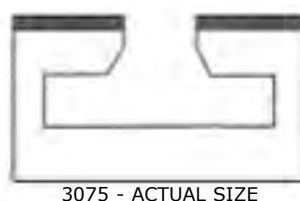
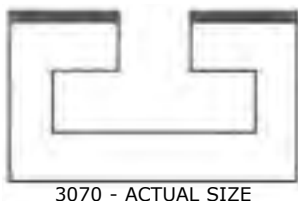
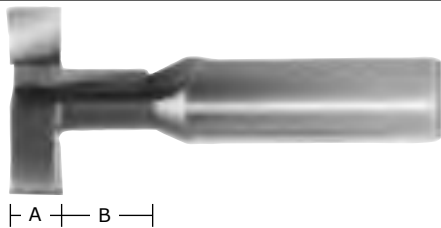

Overhang Bowl Trim - 1/2" Shank

PART	MATERIAL THICKNESS	CUT DIA.	OVERALL LENGTH	BEARING NUMBER	PRICE
2945	1/2 - 3/4	3/4	2-7/8	BB300	\$45.05



Slot and Undercut Bits - 1/4" Shank

PART	LARGE DIA.	"A" LENGTH	"B" LENGTH	OVERALL LENGTH	PRICE
3094	3/4	1/8	1/4	1-7/8	\$15.77
3094B*	3/4	1/8	1/8	1-7/8	\$22.03
3098	1	1/4	3/8	2	\$17.86
3098B*	1	1/4	1/4	2	\$23.78
3110	1-1/2	1/4	5/8	2	\$20.44
3110B*	1-1/2	1/4	1/2	2	\$26.49

* B denotes Bearing (B9) guide on shank.

These smooth cutting, two flute bits were designed to undercut the bottom of a blind pocket or cavity. Ideal for undercutting decorative patterns to give them a bold appearance. Can be used to cut all types of slots or grooves.

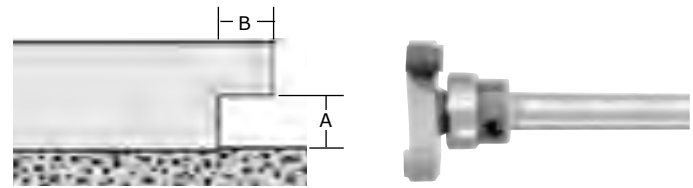

Classical Cove

1/4" SHANK

PART	RADIUS	LARGE DIA.	CUTTING LENGTH	OVERALL LENGTH	PRICE
3160	5/32	1-1/4	1/2	2	\$29.62
3162	1/4	1-3/8	3/4	2-1/4	\$33.38

1/2" SHANK

PART	RADIUS	LARGE DIA.	CUTTING LENGTH	OVERALL LENGTH	PRICE
3164	5/32	1-1/4	1/2	2-1/4	\$29.62
3166	1/4	1-3/8	3/4	2-1/2	\$33.38

Bearing Number: B3

Wood samples are actual size.

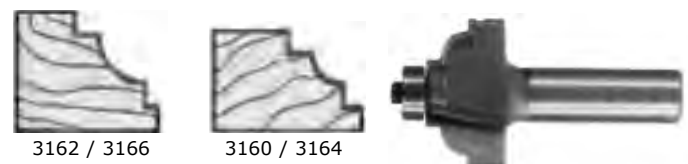

WHITESIDE MACHINE

Wavy Edge

1/4" SHANK

PART	RADIUS	LARGE DIA.	CUTTING LENGTH	OVERALL LENGTH	PRICE
3170	1/8	1-1/4	3/4	2-1/4	\$30.04

1/2" SHANK

PART	RADIUS	LARGE DIA.	CUTTING LENGTH	OVERALL LENGTH	PRICE
3172	1/8	1-1/4	3/4	2-1/2	\$30.04

Bearing Number: B



ACTUAL SIZE



Radius Flute Cutter

1/4" SHANK

PART	RADIUS	LARGE DIA.	CUTTING LENGTH	OVERALL LENGTH	PRICE
3180	1/8	1-1/8	1/4	2-5/8	\$31.70
3182	3/16	1-1/4	3/8	3-1/8	\$31.70

1/2" SHANK

PART	RADIUS	LARGE DIA.	CUTTING LENGTH	OVERALL LENGTH	PRICE
3181	1/8	1-1/8	1/4	2-3/4	\$31.70
3183	3/16	1-1/4	3/8	3-1/8	\$31.70

Bearing Number: B5



3180 / 3181



3182 / 3183

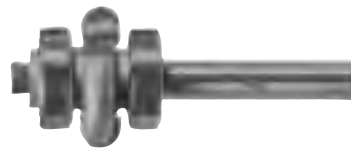

Wood samples are actual size.

Multi-Beading

1/4" SHANK

PART	RADIUS	LARGE DIA.	CUTTING LENGTH	OVERALL LENGTH	PRICE
3200	1/8	7/8	1	2-1/2	\$38.99

1/2" SHANK

PART	RADIUS	LARGE DIA.	CUTTING LENGTH	OVERALL LENGTH	PRICE
3202	1/8	7/8	1	2-3/4	\$38.99

Bearing Number: B5



Full Bead - 1/4" Shank

PART	RADIUS	LARGE DIA.	CUTTING LENGTH	OVERALL LENGTH	PRICE
3190	1/8	7/8	5/16	2-1/8	\$31.70
3192	3/16	1	1/2	2-3/8	\$33.38
3194	1/4	1-1/8	5/8	2-1/2	\$40.05
3196	3/8	1-3/8	7/8	2-3/4	\$45.05

Bearing Number: B6

Wood samples are actual size.

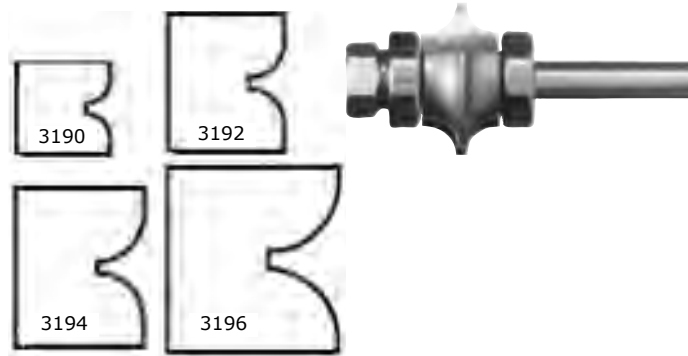

Double Round

1/4" SHANK

PART	RADIUS	LARGE DIA.	CUTTING LENGTH	OVERALL LENGTH	PRICE
3205	5/32	1-1/8	1/2	2	\$32.37
3206	7/32	1-3/8	5/8	2-1/4	\$35.04

1/2" SHANK

PART	RADIUS	LARGE DIA.	CUTTING LENGTH	OVERALL LENGTH	PRICE
3207	5/32	1-1/8	1/2	2-1/4	\$32.37
3208	7/32	1-3/8	5/8	2-1/2	\$35.04

Bearing Number: B3

Wood samples are actual size.

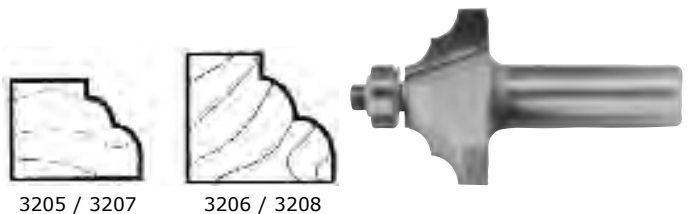

WHITESIDE MACHINE

Cove and Bead

1/4" SHANK

PART	RADIUS	LARGE DIA.	CUTTING LENGTH	OVERALL LENGTH	PRICE
3209	5/32	1-1/8	1/2	2	\$32.54
3210	1/4	1-5/16	5/8	2-1/8	\$32.54

1/2" SHANK

PART	RADIUS	LARGE DIA.	CUTTING LENGTH	OVERALL LENGTH	PRICE
3211	5/32	1-1/8	1/2	2-1/4	\$32.54
3212	1/4	1-5/16	5/8	2-3/8	\$32.54
3282	3/8	2	1-3/16	2-7/8	\$51.73

Bearing Number: B3
Wood samples are actual size.

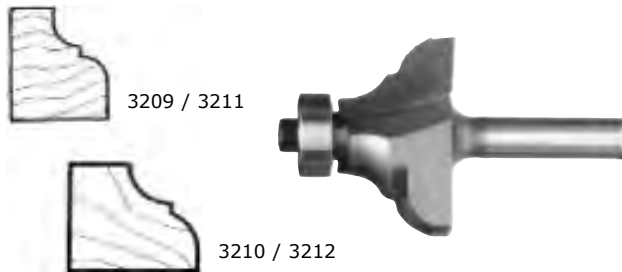

Ogee

1/4" SHANK

PART	RADIUS	LARGE DIA.	CUTTING LENGTH	OVERALL LENGTH	PRICE
3220	5/32	1-1/8	1/2	2	\$31.65
3224	1/4	1-1/2	5/8	2-1/8	\$34.21

1/2" SHANK

PART	RADIUS	LARGE DIA.	CUTTING LENGTH	OVERALL LENGTH	PRICE	
3222	5/32	1-1/8	1/2	2-1/4	\$31.65	
3226	1/4	1-1/2	5/8	2-3/8	\$34.21	
3228	9/64 and	5/16	1-5/8	5/8	2-1/2	\$40.05

Bearing Number: B3
Profile shown below are actual size.

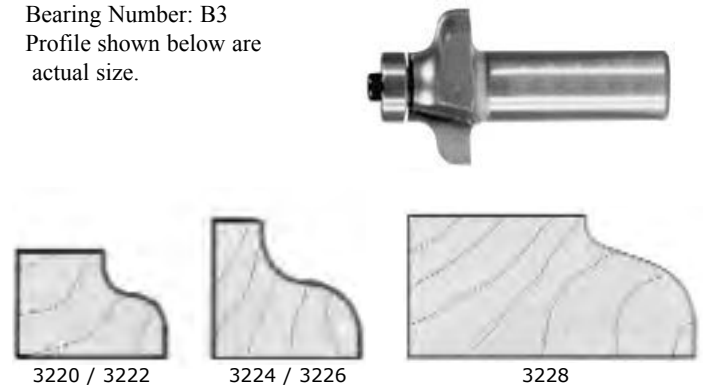

Ogee Filet

1/4" SHANK

PART	RADIUS	LARGE DIA.	CUTTING LENGTH	OVERALL LENGTH	PRICE
3214	3/16	1-3/8	5/8	2-1/8	\$31.54

1/2" SHANK

PART	RADIUS	LARGE DIA.	CUTTING LENGTH	OVERALL LENGTH	PRICE
3216	3/16	1-3/8	5/8	2-1/2	\$31.54
3218	1/4	1-5/8	3/4	2-5/8	\$36.80

Bearing Number: B3
Wood sample is actual size.

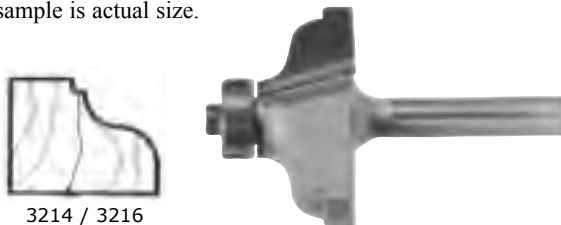

Classical Pattern

1/4" SHANK

PART	RADIUS	LARGE DIA.	CUTTING LENGTH	OVERALL LENGTH	PRICE
3230	5/32	1-1/4	1/2	2-1/8	\$33.04
3234	3/16	1-1/2	5/8	2-1/4	\$36.46

1/2" SHANK

PART	RADIUS	LARGE DIA.	CUTTING LENGTH	OVERALL LENGTH	PRICE
3232	5/32	1-1/4	1/2	2-3/8	\$33.04
3236	3/16	1-1/2	5/8	2-1/2	\$36.46

Bearing Number: B3
Wood samples are actual size.

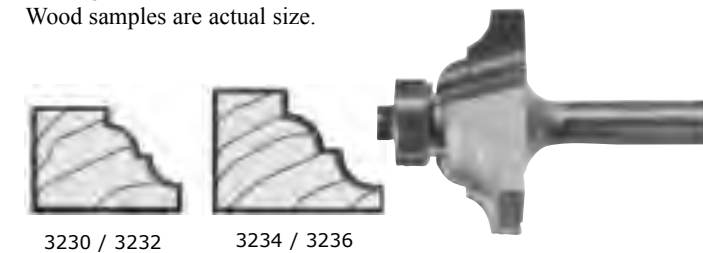

WHITESIDE MACHINE

Edge Beading

1/4" SHANK

PART	LARGE DIA.	"A" BEAD DIA.	"B" CUTTING LENGTH	OVERALL LENGTH	PRICE
3240	7/8	1/8	9/16	2	\$24.86
3244	7/8	1/4	9/16	2	\$28.37
3248	1	5/16	5/8	2-1/4	\$30.87
3252	1-1/16	3/8	3/4	2-1/4	\$32.54
3256	1-1/16	1/2	3/4	2-1/4	\$34.21

1/2" SHANK

PART	LARGE DIA.	A BEAD DIA.	B CUTTING LENGTH	OVERALL LENGTH	PRICE
3242	7/8	1/8	9/16	2-1/4	\$24.86
3246	7/8	1/4	9/16	2-1/4	\$28.37
3250	1	5/16	5/8	2-1/4	\$30.87
3254	1-1/16	3/8	3/4	2-1/2	\$32.54
3258	1-1/16	1/2	3/4	2-1/2	\$34.21
3260	1-3/8	5/8	1	2-5/8	\$42.55
3262	1-1/2	3/4	1-1/8	3	\$46.72

Bearing Number: B3
Wood samples are actual size.



3244 and 3246 3252 and 3254

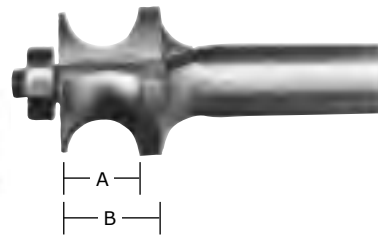

French Traditional

1/4" SHANK

PART	"R1" RADIUS	"R2" RADIUS	LARGE DIA.	CUTTING LENGTH	OVERALL LENGTH	PRICE
3270	3/16	5/16	1-1/2	5/8	2-1/8	\$40.76

1/2" SHANK

PART	"R1" RADIUS	"R2" RADIUS	LARGE DIA.	CUTTING LENGTH	OVERALL LENGTH	PRICE
3272	3/16	5/16	1-1/2	5/8	2-1/2	\$40.76

Bearing Number: B3
Wood sample is actual size.

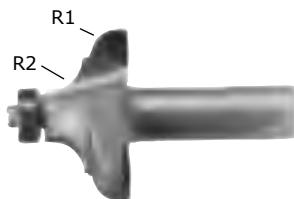

French Provincial Molding - 1/2" Shank

PART	LARGE DIA.	CUTTING LENGTH	BEAD DIA.	OVERALL LENGTH	PRICE
3280	1-3/4	1-1/8	1/4	3-1/8	\$73.42

Bearing Number: B3
Wood sample is actual size.

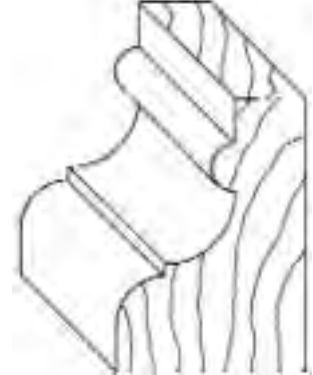
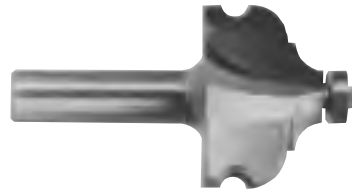

Thumbnail Table Edge

1/4" SHANK

PART	PROFILE WIDTH	LARGE DIA.	CUTTING LENGTH	OVERALL LENGTH	PRICE
3290	7/16	1-3/8	3/8	1-7/8	\$31.70

1/2" SHANK

PART	PROFILE WIDTH	LARGE DIA.	CUTTING LENGTH	OVERALL LENGTH	PRICE
3292	7/16	1-3/8	3/8	2	\$31.70
3294	1	2-1/2	3/4	2-1/2	\$65.08

Bearing Number: B3
Profiles shown are actual size.

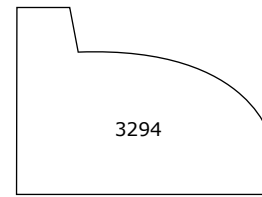
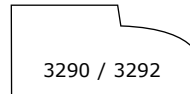

Speciality Molding - 1/2" Shank

PART	LARGE DIA.	CUTTING LENGTH	BEAD DIA.	OVERALL LENGTH	PRICE
3320	1	1	5/16	2-3/4	\$35.68
3324	7/8	1-5/8	5/16	3-1/2	\$41.72
3326	1-1/16	1-5/8	1/4	3-1/2	\$41.72
3330	1	1-5/8	1/4	3-1/2	\$45.89

Bearing Number: B3. Wood samples are actual size.

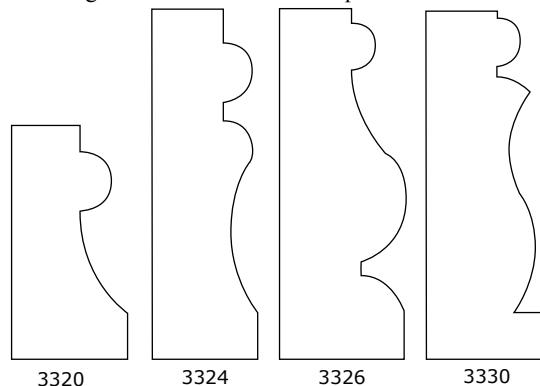

NOT ALL OF THE WHITESIDE WOOD SAMPLES ARE SHOWN ACTUAL SIZE - SEE INDIVIDUAL ITEMS FOR DETAILS

WHITESIDE MACHINE

Traditional Table Edge - 1/2" Shank

PART	PROFILE WIDTH	LARGE DIA.	CUTTING LENGTH	OVERALL LENGTH	PRICE
3228	9/16	1-5/8	5/8	2-1/2	\$40.05
3296	1	2-1/2	3/4	2-1/2	\$65.08

Bearing Number: B3
Wood samples are actual size.

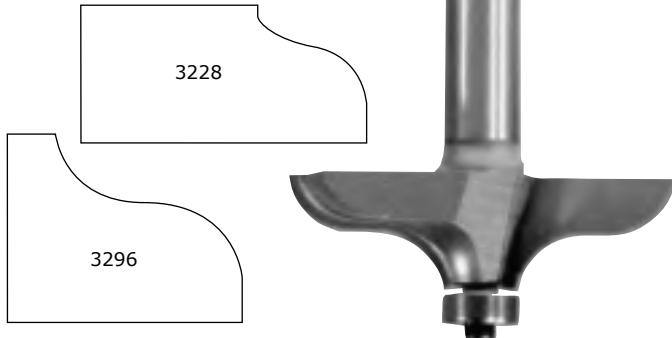

Thumbnail and Bead Table Edge 1/2" Shank

PART	PROFILE WIDTH	LARGE DIA.	CUTTING LENGTH	OVERALL LENGTH	PRICE
3302	1	2-1/2	3/4	2-1/2	\$65.08

Bearing Number: B3
Wood sample is actual size.

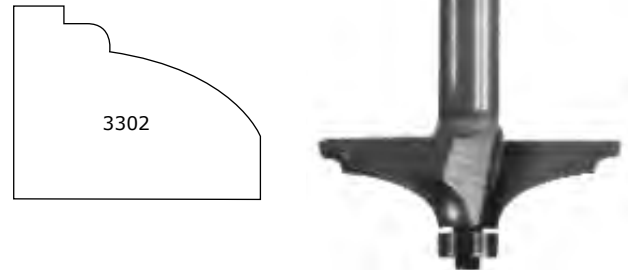

Classical Ogee Table Edge - 1/2" Shank

PART	PROFILE WIDTH	LARGE DIA.	CUTTING LENGTH	OVERALL LENGTH	PRICE
3298	1	2-1/2	3/4	2-1/2	\$65.08

Bearing Number: B3
Wood sample is actual size.

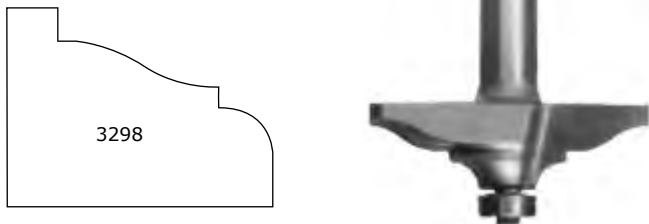

Handrail Bits - 1/2" Shank

PART	LARGE DIA.	CUTTING LENGTH	BEAD DIA.	OVERALL LENGTH	PRICE
3304	1-3/8	1-1/2	1/4	3-3/8	\$68.42
3305	1-1/4	2	1/4	3-7/8	\$75.92

Bearing Number: B3
Wood samples are actual size.

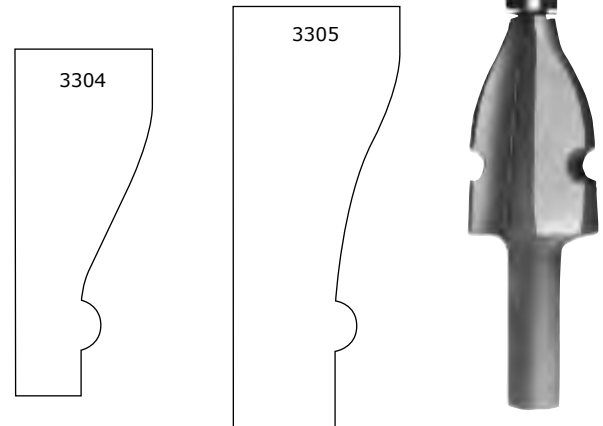

French Baroque Table Edge 1/2" Shank

PART	PROFILE WIDTH	LARGE DIA.	CUTTING LENGTH	OVERALL LENGTH	PRICE
3300	7/8	2-1/4	3/4	2-1/2	\$65.08

Bearing Number: B3
Wood sample is actual size.

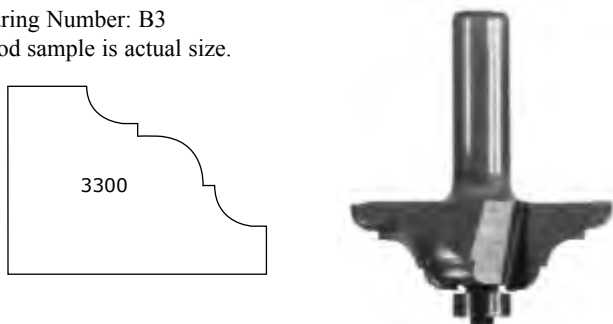

Handrail Profiles

Here are some examples of the handrail profiles which are possible using the handrail bits at the bottom of this page in combination with your choice of the table edge bits. Profiles are shown smaller than actual size.

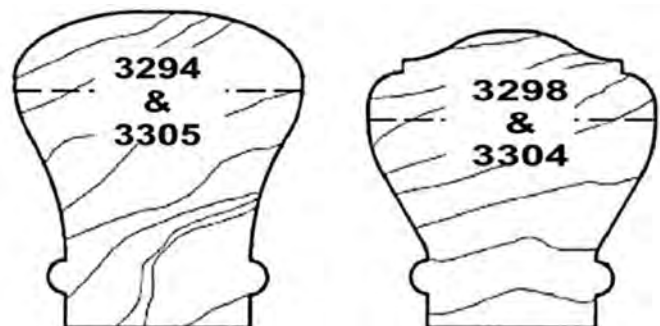

WHITESIDE MACHINE

Classical Multi-Forms - 1/2" Shank

PART	RADIUS	LARGE CUTTING DIA.	CUTTING LENGTH	BEAD DIA.	OVERALL LENGTH	PRICE
3340	3/16	1-3/8	1	1/4	2-3/4	\$63.41
3342	5/16	2-1/4	1-7/8	1/2	3-3/4	\$81.35

Bearing Number: B3

Many distinct profiles are possible by using different sections of this tool.

Wood samples are actual size.

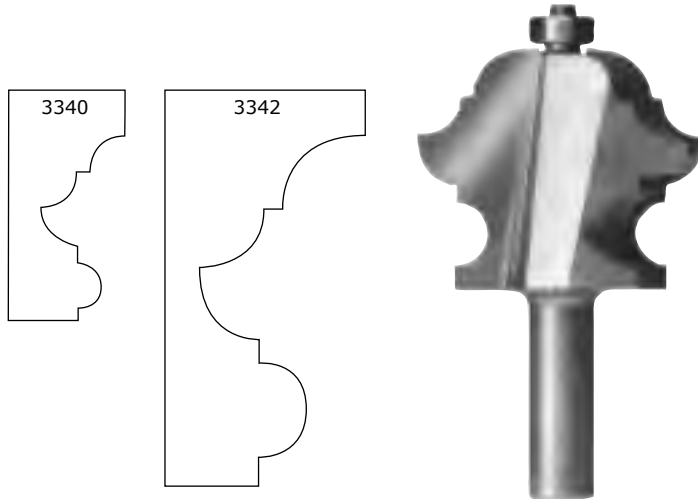

Standard Glue Joint

PART	MATERIAL THICKNESS	LARGE DIA.	SHANK DIA.	OVERALL LENGTH	PRICE
3354	1/2 - 1-1/4	1-1/2	1/2	2-3/4	\$51.73

Tool makes both cuts. Wood sample is actual size.

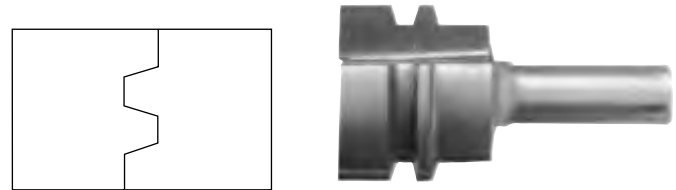

45° Lock Miter

PART	MATERIAL THICKNESS	LARGE DIA.	SHANK DIA.	OVERALL LENGTH	PRICE
3360	1/2 to 1-1/4	3-1/8	1/2	2-7/8	\$101.78
3362	1/2 to 3/4	2	1/2	2-3/8	\$75.09

Note: 3362 is recommended for stock thickness 1/2" - 3/4". Each individual tool makes both cuts.

Wood sample is actual size.



Locking Drawer Glue Joints

PART	LARGE DIA.	CUTTING LENGTH	SHANK DIA.	OVERALL LENGTH	PRICE
3346	3/4	1/2	1/4	1-7/8	\$28.37
3347	1	1/2	1/2	2-1/8	\$30.04
3350	1	1	1/4	2-3/8	\$44.32
3352	1	1	1/2	2-3/8	\$44.32

Wood samples are actual size. Tool makes both cuts.

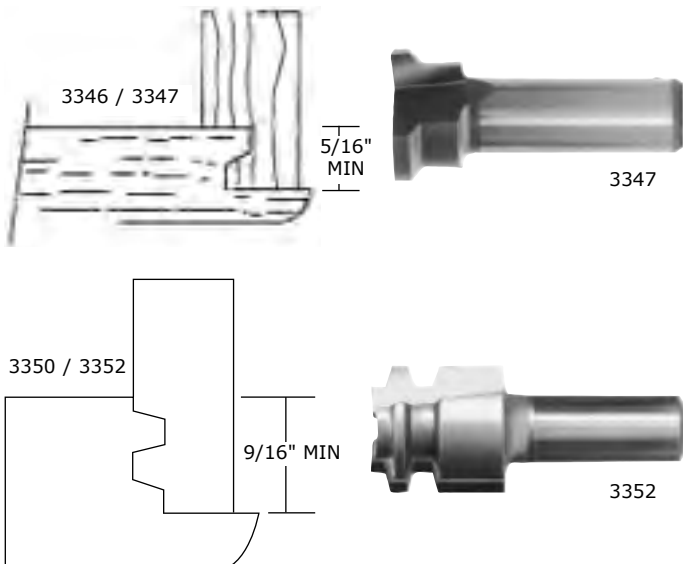

Wedge Tongue and Groove 1/2" Shank

PART	MATERIAL THICKNESS	LARGE DIA.	SHANK DIA.	OVERALL LENGTH	PRICE
3370	5/8 to 1-1/4	1-1/4	1-1/4	2-7/8	\$100.12

* Order 3370 for Two Piece Set.

* Order 3370A or 3370B for individual cutters.

Wood sample is actual size.

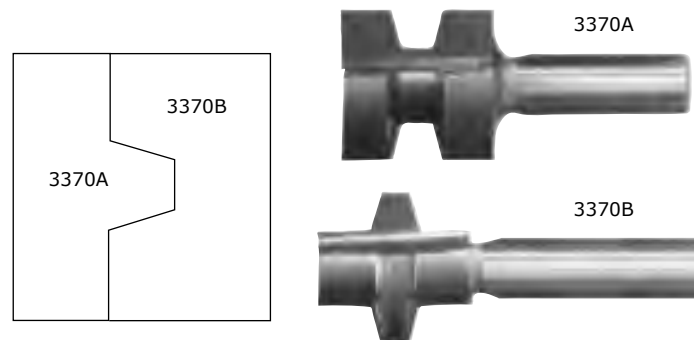

WHITESIDE MACHINE

Straight Tongue and Groove with Ball Bearing Guide - 1/2" Shank

PART	MATERIAL THICKNESS	LARGE DIA.	CUTTING LENGTH	OVERALL LENGTH	PRICE
3373	1/2 to 1-1/4	1-1/4	1-1/4	3-1/8	\$100.12

* Order 3373 for two piece set
 * Order 3373A or 3373B for individual cutters.
 Wood sample is actual size.

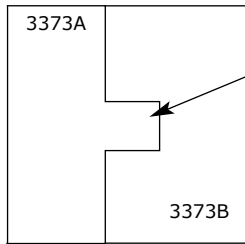

Fine Finger Joint - 1/2" Shank

PART	MATERIAL THICKNESS	LARGE DIA.	FINGER DEPTH	OVERALL LENGTH	PRICE
3390	5/16 to 1-1/4	1-3/8	5/16	3-1/4	\$96.78

Bearing Number: B4. Tool makes both cuts.

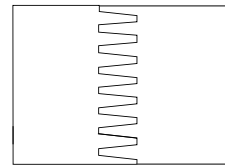

Two-Piece Edge Banding Bit Set

3/4" Thickness, 1/2" shank

- #3400(set) \$71.28
- #3401 \$32.40
- #3402 \$44.55

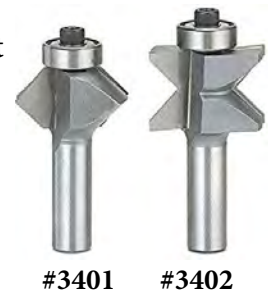

Vee Panel Tongue and Groove with Ball Bearing Guide - 1/2" Shank

PART	MATERIAL THICKNESS	LARGE DIA.	CUTTING LENGTH	OVERALL LENGTH	PRICE
3374	5/8 to 1*	1-5/8	1	2-3/4	\$120.98

* Order 3374 for two piece set.
 * Order 3374A or 3374B for individual cutters.
 * Material over 1" thick requires a second cut on the tongue profile to waste away excess stock.
 Wood sample is actual size.

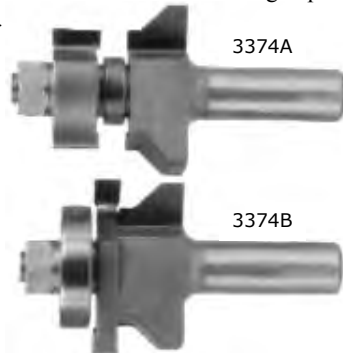
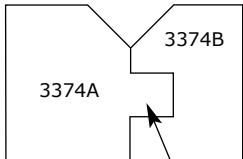

Multi-Side Bits - 1/2" Shank

PART	OF SIDES	STOCK (MAX.)	LARGE DIA.	ANGLE	PRICE
3506	6 or 12	7/8	1-7/8	60 / 30°	\$39.21
3508	8	7/8	1-3/4	45 / 45°	\$39.21
3516	16	1	1-5/8	67-1/2/22-1/2°	\$39.21

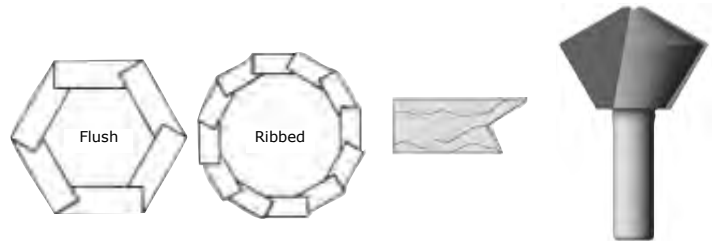

Plunge Ogee

PART	"A" RADIUS	"B" SMALL DIA.	"C" LARGE DIA.	CUTTING LENGTH	OVERALL LENGTH	PRICE
2051*	3/16	1/4	5/8	3/8	1-3/4	\$25.03
3602*	3/32	1/8	1/2	1/4	1-3/4	\$20.03
3604*	3/16	3/16	7/8	1/2	2	\$21.69
3606**	3/16	3/16	7/8	1/2	2	\$22.28
3608**	3/16	3/8	1-1/8	1/2	2-1/4	\$28.37

* 2051, 3602 and 3604 have 1/4" Shanks

** 3606 and 3608 have 1/2" Shanks

Wood samples are actual size.

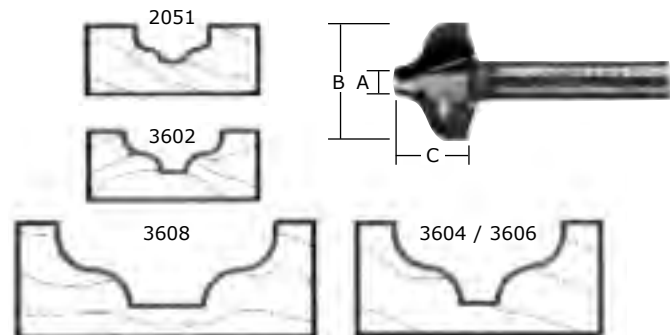

Tongue and Groove Assembly 1/2" Shank

PART	MATERIAL THICKNESS	LARGE DIA.	TONGUE WIDTH	BEARING	PRICE
3375	1/2 to 13/16	1-5/8	9/32	5	\$46.72

Tool makes both cuts "A" and "B".
 Replacement Parts: Groover - 3375G; Arbor - A260
 Wood sample is actual size.

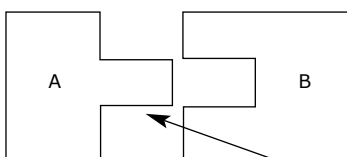

1/4" x 3/8" Tongue



WHITESIDE MACHINE

Classical Round Bottom

1/4" SHANK

PART	RADIUS	LARGE DIA.	CUTTING LENGTH	OVERALL LENGTH	PRICE
3720	1/8	5/8	1/2	2	\$24.62
3725	1/8	3/4	1/2	2	\$26.70
3730	3/16	7/8	1/2	2	\$28.37

1/2" SHANK

PART	RADIUS	LARGE DIA.	CUTTING LENGTH	OVERALL LENGTH	PRICE
3735	3/16	7/8	1/2	2-1/8	\$28.37
3740	3/16	1-1/8	1/2	2-1/8	\$33.38
3750	7/32	1-3/8	9/16	2-1/2	\$41.72



Wood samples are actual size.



Classical Flat Bottom

1/4" SHANK

PART	RADIUS	LARGE DIA.	CUTTING LENGTH	OVERALL LENGTH	PRICE
3770	7/64	3/4	3/8	2	\$28.37

1/2" SHANK

PART	RADIUS	LARGE DIA.	CUTTING LENGTH	OVERALL LENGTH	PRICE
3780	13/64	1-3/8	9/16	2-1/2	\$41.72

Wood samples are actual size.

These bits are ideal for adding bearings to the shank to produce the following templates. Select a bearing with the same inside diameter as your shank size. Outside diameter should be the same size or larger than the large diameter of your router bit. Secure bearings with a lock collar. Use Lock Collar LC-1/4 for 1/4" shanks or LC-1/2 for 1/2" shanks.



Model Train Track Bits

PART	DESCRIPTION	LARGE DIA.	CUTTING LENGTH	PRICE
3900	Female Connector (Ball Cutter)	1/2	3/4	\$23.36
3902	Male Connector (1/2 Round Cutter)	1-3/16	11/16	\$45.43
3910	Track Single Groove Bit	1/2	1/4	\$23.36
3915	Track Double Groove Bit	1-1/8	1-1/2	\$36.71

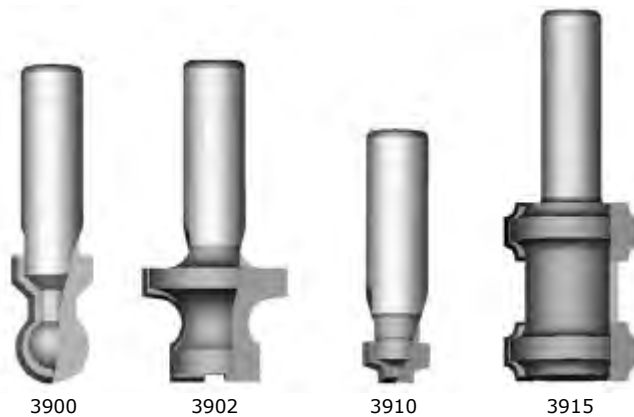
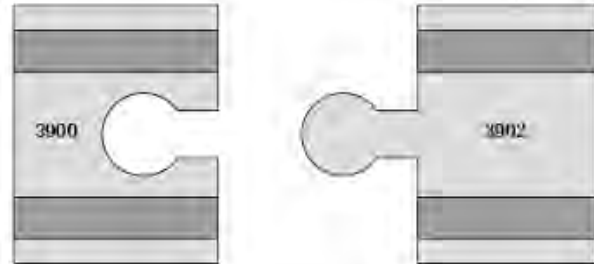

Miniature Raised Panel Bits with Ball Bearing Guide

PART	LARGE DIAMETER	SHANK DIAMETER	PRICE
5750	1-3/4	1/2	\$43.39
5751	1-3/4	1/2	\$43.39

These Raised Panel bits offer a reduced pattern ideal for smaller projects. Available in your choice of cove or ogee profile shown below. To work with the miniature Stile and Rail bits, set depth to leave a 5/32" thick tongue. Leaves only a 3/8" reveal after assembly! Now you can use raised panel construction for small doors, chests, jewelry boxes, etc.

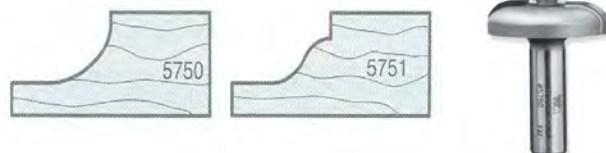

WHITESIDE MACHINE

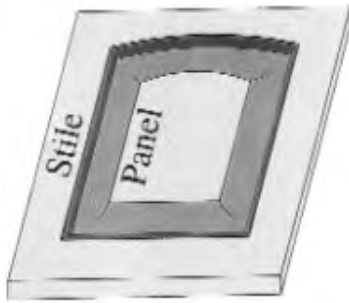

MDF Doors

The Tooling on this page is designed to give the illusion of raised panel door construction in MDF and solid panel doors. These bits, when used individually, produce a nice simple raised panel effect in one pass. Or use one of the "Panel" bits in conjunction with one of the "Stile" bits to create a more authentic raised panel reveal. Many different Stile and Panel combinations are possible. See profiles at the bottom of page.

Although originally designed for solid door machines and CNC routers, the addition of a bearing to the shank will allow you to cut your pattern by following an edge guide. The guide can be four strips clamped around the perimeter of the door. The top strip may be curved for an arched pattern. Follow the guide and rout both profiles. There's no need to move the guide for the second cut. A larger bearing on the panel bit takes care of the offset. Use Bearing B16 for the Stile bits and Bearing B24 for the Panel bits. Secure the bearings to the

shank with a LC-1/2 Lock Collar. When making the second cut, match the depth setting of the first cut to obtain a pattern with a flat bottom - Or vary the depth to add an extra distinctive step in the bottom of your reveal. Complete the door by adding a door edge pattern around the outside edge.

"Stile" Profile Bits - 1/2" Shank

PART	STYLE	LARGE DIAMETER	OVERALL LENGTH	PRICE
5610*	Bead	7/8	2-1/2	\$38.38
5620	Traditional	1-1/4	2-1/2	\$41.72
5630	Ogee	1-1/4	2-1/2	\$41.72
5645	Straight	1-1/4	2-1/2	\$41.72

* If you have a unique machine, it is recommended that you purchase. **Part 2057** (\$35.67) instead of 5610.

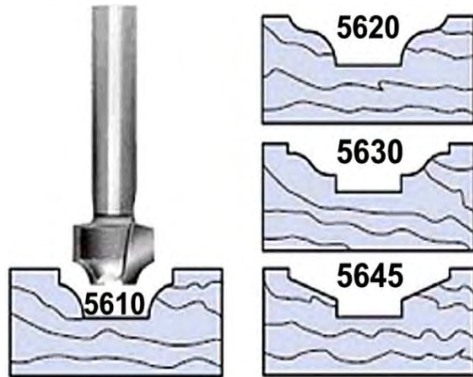

"Panel" Profile Bits - 1/2" Shank

PART	STYLE	LARGE DIAMETER	OVERALL LENGTH	PRICE
5710*	Cove	1-1/2	2-1/2	\$60.07
5720	Straight	1-1/2	2-1/2	\$60.07
5725	Ogee	1-1/2	2-1/2	\$60.07

* If you have a unique machine, it is recommended that you purchase **Part 97-320** (\$55.62) instead of 5710.

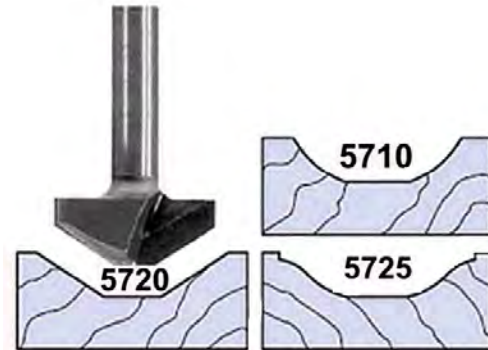

Stile and Panel Combination Profiles

wood samples are actual size

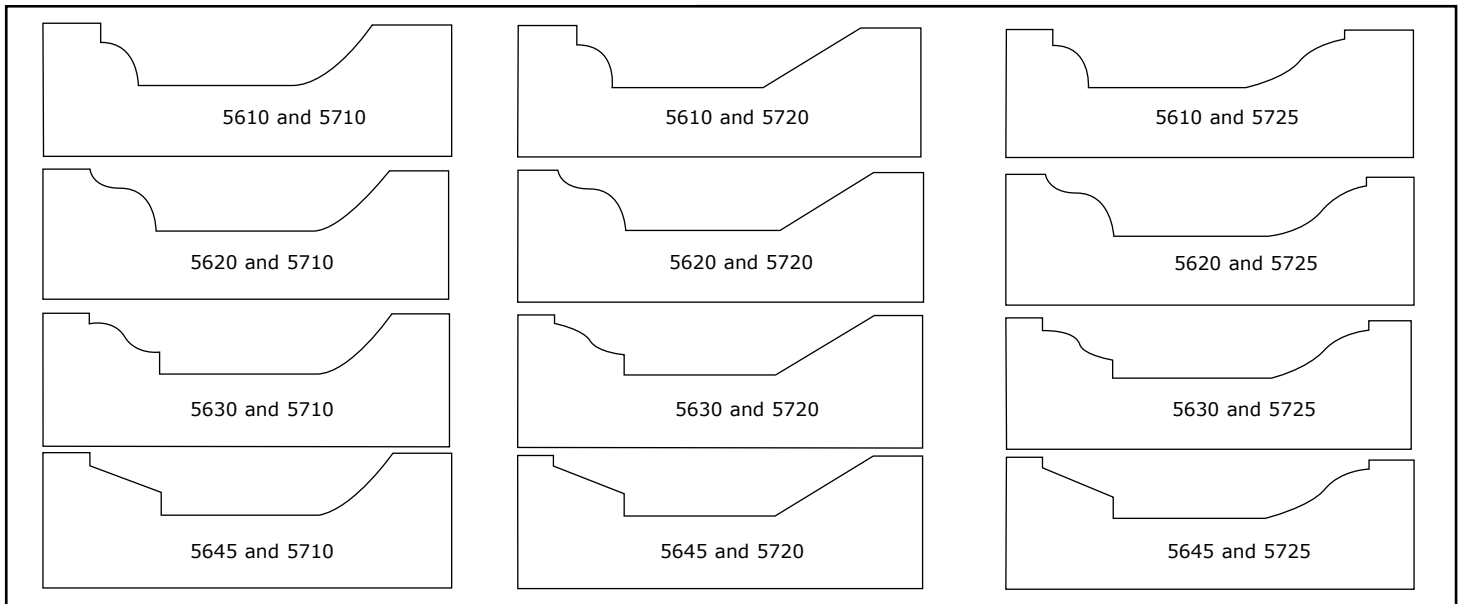

WHITESIDE MACHINE

Medium Raised Panel Bits 1/2" Shank

PART	PATTERN	LARGE DIA.	CUTTING LENGTH	OVERALL DIA.	PRICE
5950	Cove	2-1/2	1	2-1/4	\$62.57
5951	Ogee	2-1/2	1	2-3/8	\$62.57
5952	25° Straight	2-1/2	1	2-3/8	\$62.57
5953	Classic Ogee	2-1/2	1	2-3/8	\$62.57
5954	Ogee Bead	2-1/2	1	2-3/8	\$62.57

Wood samples are actual size.

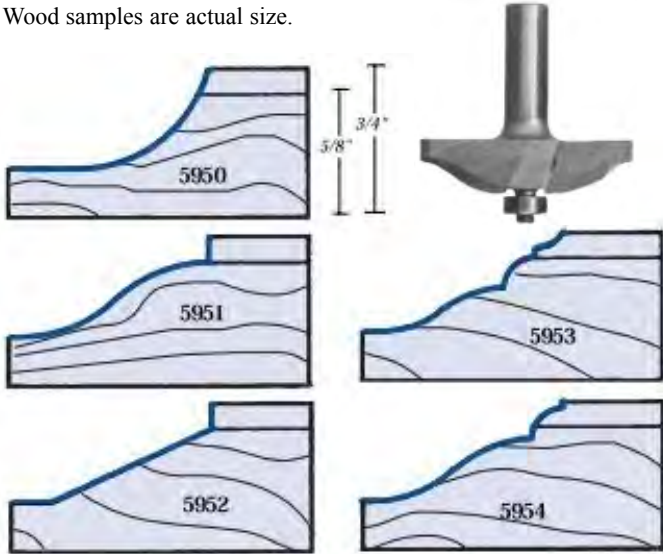

Large Raised Panel Bits - 1/2" Shank

PART	LARGE DIA.	LENGTH OF PROFILE	OVERALL BEARING	PRICE
5900A	3-1/4	1-3/8	2-3/4 B3	\$90.11
5900B	3-1/4	1-3/8	2-3/4 B3	\$90.11
5900C	3-1/4	1-3/8	2-3/4 B3	\$90.11
5900E	3-1/4	1-3/8	2-3/4 B3	\$90.11
5900F	3-1/4	1-3/8	2-3/4 B3	\$90.11
5900G	3-1/4	1-3/8	2-3/4 B3	\$90.11
5900H	3-1/4	1-3/8	2-3/4 B3	\$90.11
6000A	3-3/8	1-7/16	2-3/4 B3	\$105.12
6000B	3-3/8	1-7/16	2-3/4 B3	\$105.12
6000C	3-3/8	1-7/16	2-3/4 B3	\$105.12
6000E	3-3/8	1-7/16	2-3/4 B3	\$105.12
6000F	3-3/8	1-7/16	2-3/4 B3	\$105.12
6000G	3-3/8	1-7/16	2-3/4 B3	\$105.12
6000H	3-3/8	1-7/16	2-3/4 B3	\$105.12

5900 Series - 2 Wing 3-1/4 Diameter

6000 Series - 3 Wing 3-3/8 Diameter

Wood samples are actual size.

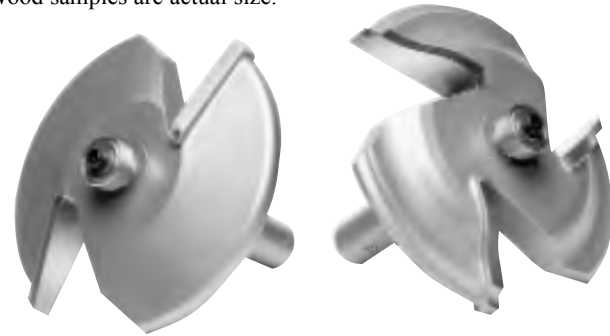

Large Raised Panel Bits with Back Cutter

PART	LARGE DIAMETER	SHANK DIAMETER	PRICE
5920B	3-1/4	1/2	\$106.79
5920C	3-1/4	1/2	\$106.79
5920E	3-1/4	1/2	\$106.79

Raised panel bits with back cutters allow you to cut the front reveal and the optional back cut at the same time - and guarantees a 1/4" tongue.

Wood samples are actual size.

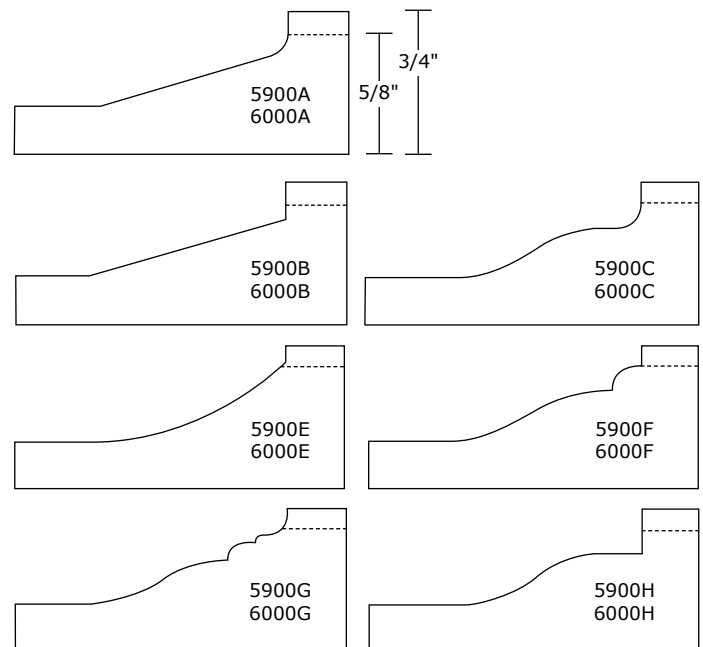
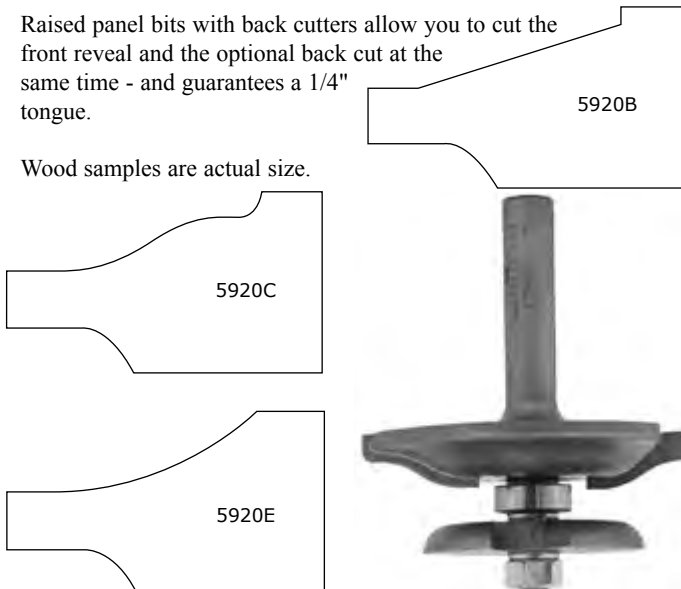

WHITESIDE MACHINE

Full Size Stile and Rail - 1/2" Shank TWO PIECE SETS

PART	STYLE	CUTTING LENGTH	REVEAL WIDTH	PRICE
6001	Round	1	1/4	\$106.79
6002	Ogee	7/8	3/8	\$106.79
6003	Bead	7/8	3/8	\$106.79
6004	Straight	7/8	3/8	\$106.79
6005	Traditional	7/8	3/8	\$106.79
6006	Classical	7/8	3/8	\$106.79

INDIVIDUAL CUTTERS

PART	STYLE	CUTTING LENGTH	REVEAL WIDTH	PRICE
6001A	Round (Stile)	1	1/4	\$58.40
6001B	Round (Rail)	1	1/4	\$58.40
6002A	Ogee (Stile)	7/8	3/8	\$58.40
6002B	Ogee (Rail)	7/8	3/8	\$58.40
6003A	Bead (Stile)	7/8	3/8	\$58.40
6003B	Bead (Rail)	7/8	3/8	\$58.40
6004A	Straight (Stile)	7/8	3/8	\$58.40
6004B	Straight (Rail)	7/8	3/8	\$58.40
6005A	Traditional (Stile)	7/8	3/8	\$58.40
6005B	Traditional (Rail)	7/8	3/8	\$58.40
6006A	Classical (Stile)	7/8	3/8	\$58.40
6006B	Classical (Rail)	7/8	3/8	\$58.40

REPLACEMENTS

PART	DESCRIPTION	PRICE
6625	Groover	\$16.69

Bearing: B5

Make full size Stile and Rail joints on your router table. The interlocking design plus the raised panel groove are both cut in one pass. Ball bearing guides control the cutting depth and also allow use on the rounded, arched, or special shaped doors. With these two piece sets, simply switch router bits to change from cutting stiles to cutting rails. Ideal for stock from 5/8" to 7/8" thick.

STILE	RAIL	STILE	RAIL
6001 - ROUND		6004 - STRAIGHT	
6002 - OGEE		6005 - TRADITIONAL	
6003 - BEAD		6006 - CLASSICAL	

All wood samples on this page are actual size

Plywood Panel Stile and Rail

PART	DESCRIPTION	PRICE
6000X	Full Size Stile and Rail to Plywood conversion kit	\$37.55
6001X	Round Stile and Rail Set for Plywood	\$116.81
6002X	Ogee Stile and Rail Set for Plywood	\$116.81

This set-up is for cabinet door construction with undersized 1/4" plywood panels. (Actual panel thickness of 7/32" or 5.5mm).

Whiteside's conversion kit 6000X converts the regular full size Stile and Rail Bits to the narrower groove required for these plywood panels. This kit gives you the flexibility to do either plywood panels or raised panels. Plus, it can be used on any Whiteside full size Stile and Rail Bits that you may already own. 1/2" Shank Only.

Stile and Rail Glass Doors

Make the Stile and Rail cuts for glass doors using Whiteside's standard Stile and Rail Bits. No extra components are required. All that's needed is to stagger the cutting edges and "stack" both groovers on the Stile bit. Use both bearings (no groover) on the Rail bit. See Drawing. Now make your cuts just like in normal door construction - Cut the inside edges of all four pieces with the Stile Bit. Trim the ends of the Rails with the Rail bit. Assemble door and insert glass pane. Use clips or corner trim mold on the back side to hold the pane in place.

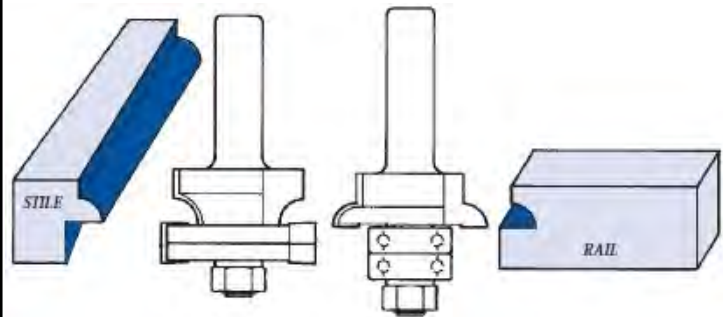

Miniature Stile and Rail Sets

PART	STYLE	REVEAL WIDTH	LARGE DIA.	STOCK SIZE	PRICE
5740	Round	3/16	1-1/8	7/16 to 3/4	\$116.80
5742	Ogee	1/4	1-1/8	7/16 to 3/4	\$116.80

For Individual Bits

Add A to Part Number for Stile Cutter; Add B to Part Number for Rail Cutter

Example: 5740A- Round Stile Cutter

Replacement Parts

Stile Groover - 5740AG; Rail Groover - 5740BG

Bearing Number: B27

These miniature Stile and Rail sets work just like their full size counterparts (see below). They feature a reduced pattern and a reduced tongue and groove (5/32" x 1/4") suitable for smaller projects. Works with 7/16" to 3/4" thick stock.

STILE	RAIL	STILE	RAIL
5740 - ROUND		5742 - OGEE	

WHITESIDE MACHINE

Raised Panel Door Construction

Choose stock size as appropriate for your project. For example, 3/4" x 2" stile and rails and 5/8" thick panels (without optional back cut) are common for cabinet doors. Use your stock size and door size to calculate the following:



- Stile length = Door Height
- Rail Length = Door Width - width of both stiles + Interlock
- Panel Height = Door height - width of both rails + interlock - Expansion
- Panel width = Rail Length - Expansion
- Interlock = 3/4" (3/8" per side) on Whiteside full size Stile and Rail bits or 1/2" (1/4" per side) For Whiteside miniature Stile and Rail.
- Expansion: Generally 1/8" on cabinet doors. Can vary with door size, green condition of wood, anticipated exposure to high Humidity, and species of wood.

Use the Stile Bit to cut the entire length of the inside edge on both the stiles and the rails. Use the Rail bit to make the matching cross grain end cuts on the rails only. Use the Raised Panel bit to cut all four sides of each raised panel face down on the router table. Set Raised Panel bit height for proper tongue thickness. Tongue should be 1/4" for the full size Stile and Rail bits or 5/32" for miniature ones. Allow extra stock if you plan to use the optional back cutter. Use the Standard Glue joint or biscuits for added strength when gluing up larger panels. Cut all components and test fit. Then glue up and reassemble. Glue only the stile and rail joints.

The panel should be allowed to "float" to allow for expansion and contraction. You may choose to use anti-rattle snakes to prevent the panel from rattling. Make you own by running a 1/8" bead of 100% silicone caulk on wax paper. Allow to dry. Cut into pieces about 3/4" long. Insert in each groove at every corner while assembling. Check the door for squareness immediately after gluing up. It may also be helpful to pre-stain the raised panel because part of the concealed portion of the tongue may become visible later due to contraction. Complete the door by adding a door edge pattern around the outside edge.

Raised Panel Back Cutter

PART	LARGE DIAMETER	SHANK DIAMETER	PRICE
5850	1-3/4	1/2	\$43.38

This bit offers a safe and economical way to make that optional backside cut on raised panels. It is suitable for use with any of our Raised Panel bits.

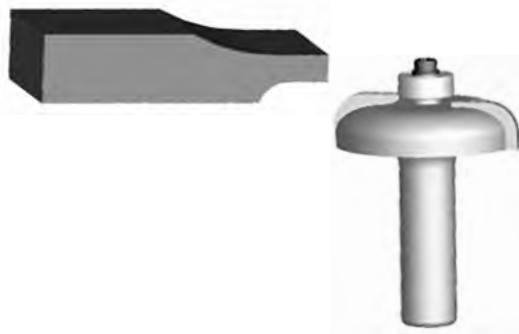

Vertical Panel Bits

PART	PATTERN	LARGE DIA.	CUTTING LENGTH	OVERALL LENGTH	PRICE
5801	Cove	1	1-1/2	3	\$60.07
5802	Straight Cove	1	1-1/2	3	\$60.07
5804	Ogee Cove	1	1-1/2	3	\$60.07
5805	Ogee Bead	1	1-1/2	3	\$60.07

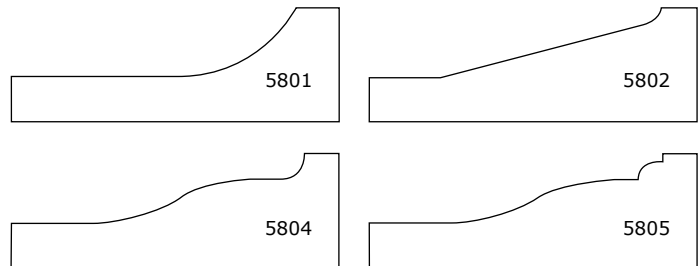

WHITESIDE MACHINE

Door Edge Bits - Complete Edge 1/2" Shank

PART	STYLE	LARGE DIAMETER	CUTTING LENGTH	PRICE
6010	Recessed Doors	1-3/8	1-1/8	\$54.23
6015	Finger Pull	1-1/2	7/8	\$45.89
6016	Reversible	1-5/8	15/16	\$54.75

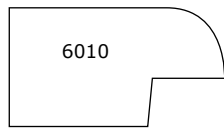

Wood samples are actual size.

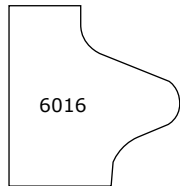
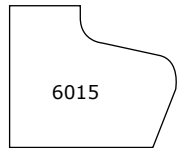

Door Edge Bits - Front Face Edge with Ball Bearing Guide 1/4" SHANK

PART	LARGE DIA.	CUTTING LENGTH	SHANK DIA.	OVERALL LENGTH	PRICE
3290	1-3/8	3/8	1/4	1-7/8	\$31.70
3292	1-3/8	7/16	1/2	2	\$31.70
6020	1-9/16	17/32	1/2	2-1/4	\$38.38
6021	1-3/4	5/8	1/2	2-1/4	\$38.38
6022	1-3/4	5/8	1/2	2-1/4	\$38.38
6023	1-3/4	5/8	1/2	2-1/4	\$38.38

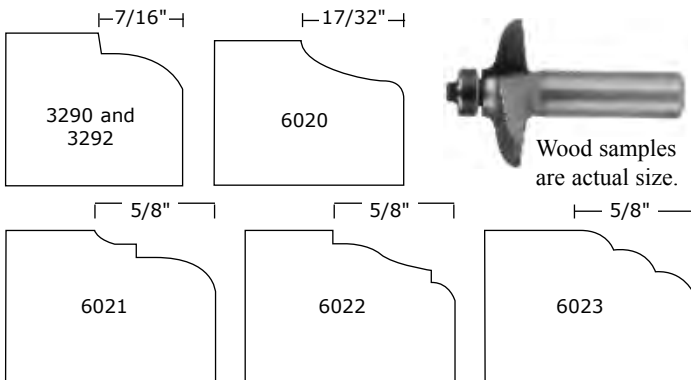

Wood samples are actual size.

Drawer Pull - European Style 1/2" Shank

PART	RADIUS	LARGE DIA.	CUTTING LENGTH	OVERALL LENGTH	PRICE
6024	3/16	3/4	7/8	2-3/8	\$45.05
6026	1/4	1-1/2	13/16	2-3/8	\$49.64

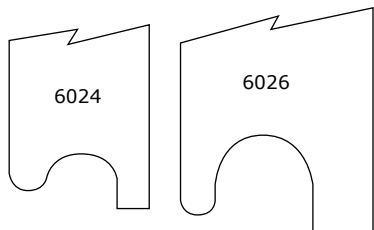

Wood samples are actual size.

Drawer Edge Finger Pull - 1/2" Shank

PART	LARGE DIAMETER	CUTTING LENGTH	OVERALL LENGTH	PRICE
6032	1-1/4	3/4	2-1/2	\$28.79

Bearing Number: B3



Window Sill Edge - 1/2" Shank

PART	RADIUS	LARGE DIA.	PROFILE LENGTH	OVERALL LENGTH	PRICE
6045	7/32	1-1/4	13/16	2-7/8	\$40.88
6046	3/8	1-7/16	1-1/8	3-3/8	\$49.64

B16 Bearing + LC-1/2" Lock Collar on 6045
B18 Bearing + LC-1/2" Lock Collar on 6046

Wood samples are actual size.

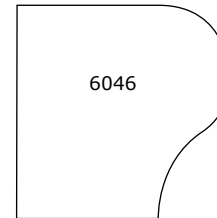
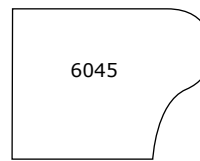

Boring Bits

PART	CUTTING DIAMETER	SHANK DIAMETER	OVERALL LENGTH	PRICE
6100	2-1/8	1/2	6-1/8	\$85.10
6140	35mm	3/8	2-3/8	\$40.05



FaceFrame Counterbores Carbide Tipped -3/8" Shank

PART	COUNTERBORE DIA.	PILOT DIA.	LENGTH	TYPE	PRICE
FF301	3/8	.136	4	Standard	\$28.37
FF301SP*	3/8	.126	4	Spiral Flute	\$34.04
FF302	3/8	.136	6	Long	\$49.44
FF303	Replacement	.136 Pilot	Fishtail Drill Bit (HSS)		\$4.84
FF304	Replacement	Set Screw - Uses 5/64" Hex Key			\$0.23



WHITESIDE MACHINE

CNC Spoilboard

Surfacing STRAIGHT CUT

PART	LARGE DIAMETER	SHANK DIAMETER	OF WINGS	PRICE
SB25-2	2-1/2	1/2	2	\$253.63
SB40-2	4	3/4	2	\$263.64
SB40-3	4	3/4	3	\$283.67

UP SHEAR CUT

PART	LARGE DIAMETER	SHANK DIAMETER	OF WINGS	PRICE
SBU25-2	2-1/2	1/2	2	\$283.67
SBU40-3	4	3/4	3	\$336.81

CARBIDE INSERTS: INDEXABLE - 4 CUTTING EDGES

PART	DESCRIPTION	SIZE	PRICE
SB-Insert	10 Piece Pak	14mm x 14mm x 2mm	\$28.37
SB-Screw	Replacement Screw	M5x7	\$2.94
SB-Wrench	Insert Wrench	T-15 Torx	\$6.91



CNC Spoilboard Cutters

Carbide Tipped



Part #	Cutting Dia.	Cutting Length	Shank Dia	Num of Wings	Price
6210	1	1/4	1/4	3	\$ 23.40
6220	2	1/2	1/2	4	\$ 56.22



Cove Nose Spiral

Part #	Cutting Dia	Corner Radius	Cutting Length	OAL	Price
RU2075CN	1/4	1/16	3/4	2-1/2	\$21.00

Conical Ball Nose Spirals



Part #	Radius	Ball Dia	Included Angel	OAL	Price
SC64	1/32	1/16	11°	2-1/2	\$40.50
SC66	1/16	1/8	7°	2-1/2	\$40.50

PART	CUTTING DIAMETER	CUTTING LENGTH	OVERALL LENGTH	PRICE
6050	1-3/8	7/8 to 1-5/8	3-5/8	\$85.10

Replacement Parts

Profile Cutter: 6050H

Arbor: A380

Straight Cutter: 6050G

Spacer: 6050SP

Bearing Number: B5

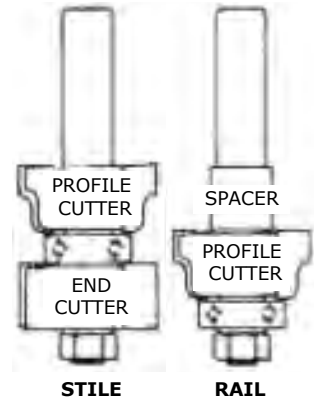

Window Sash

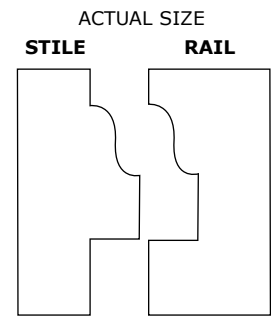
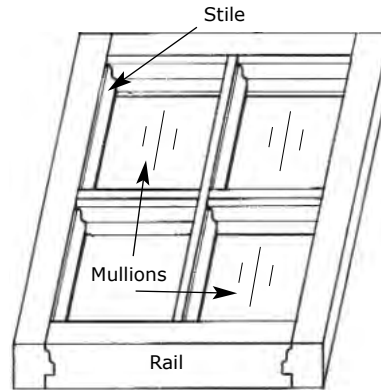

Drawer Slot Cutters (Jemco Machines)

PART	CUTTING DIAMETER	BORE	KERF	NO. FLUTES	PRICE
6800	1-1/4	3/8 to 24 the	3/16	4	\$20.86
6801	1-1/4	3/8 to 24 the	3/16	6	\$25.03
6804	1-1/4	3/8 to 24 the	1/4	4	\$20.86
6805	1-1/4	3/8 to 24 the	1/4	6	\$25.03



Drawer Slot Cutter Arbors

PART	SHANK DIAMETER	OVERALL LENGTH	THREAD	PRICE
6890	1/4	2	3/8 to 24	\$6.68
6891	3/8	2	3/8 to 24	\$6.68
6892	1/2	2	3/8 to 24	\$6.68
6896	3/8	3-1/4	3/8 to 24	\$16.69



Slotting Cutter Arbors Includes B5 Bearing for 1/2" depth cut

PART	SHANK DIAMETER	OVERALL LENGTH	PRICE
A200B	1/4	2-3/8	\$7.37
A205B	3/8	2-3/8	\$9.05
A210B	1/2	2-3/8	\$7.37
A220B	1/2	4	\$13.64

NOTE - A220B has an extra long shank for extended reach.
 Use B20 Bearing for 9/16" depth of cut.
 Use B25 Bearing for 3/8" depth of cut.
 Use B26 Bearing for 1/4" depth of cut.
 Use B27 Bearing for 5/8" depth of cut.

Arbors

PART	SHANK DIA.	ARBOR DIA.	ARBOR LENGTH	OVERALL LENGTH	PRICE
A200	1/4	5/16	7/8	2-3/8	\$3.76
A205	3/8	5/16	7/8	2-1/2	\$5.84
A210	1/2	5/16	7/8	2-5/8	\$3.76
A220	1/2	5/16	7/8	4	\$10.01
A250	1/4	5/16	1-3/16	2-3/4	\$5.00
A260	1/2	5/16	1-3/16	2-7/8	\$5.00
A300	1/4	5/16	1-7/16	3	\$5.42
A310	1/2	5/16	1-7/16	3-3/16	\$5.00
A375	1/2	5/16	1-3/4	3-3/8	\$7.51
A550	1/2	1/2	1-7/8	3-7/8	\$10.01
A560	1/2	1/2	2-3/8	4-3/8	\$13.35

Arbors include nut and washer.



Slotting Cutters 1-7/8" Cutting Diameter 5/16" Bore

3 WING

PART	KERF DECIMAL	KERF FRACTION	NUMBER OF WINGS	PRICE
6700A	.062	1/16	3	\$12.52
6701A	.070	---	3	\$14.15
6702A	.080	---	3	\$14.15
6703A	.094	3/32	3	\$13.97
6704A	.100	---	3	\$16.02
6704C	.110	7/64	3	\$16.61
6705A	.125	1/8	3	\$15.74
6708A	.156	5/32	3	\$15.74
6709A	.187	3/16	3	\$15.74
6710A	.250	1/4	3	\$15.74
6712A	.281	9/32	3	\$19.52
6700B	.062	1/16	4	\$18.72
6703B	.094	3/32	4	\$20.98
6705B	.125	1/8	4	\$23.13
6710B	.250	1/4	4	\$23.78

Special sizes available upon request.



Solid Brass Inlay Kit

PART	DESCRIPTION	PRICE
9500	Solid Brass Inlay Kit	\$37.85

Whiteside's Brass Inlay Kit allows you to make perfect fitting inlays for decoration or repairs. Simply cut your template from 1/4" thick material and trace it with your router to cut both the cavity in your workpiece and the matching inlay to be inserted. Instructions are included. Our kit includes a special centering pin to insure exact alignment with router spindle. Also includes a 1/8" Solid Carbide Spiral Router Bit (Part RD1600).



Square Corner Chisel

PART	DESCRIPTION	PRICE
9600	Square Corner Chisel	\$22.52

Use this tool to square up the round corners left behind when routing hinge mortises. Hold unit in mortise corner and strike with hammer. Our chisel features a sharp 3/8" square hardened steel cutting blade. Made in USA by Whiteside Machine Company.



Hex Key Wrenches

PART	SIZE	APPLICATION	PRICE
HK-1/16	1/16	Bearing Lock Collars	\$0.83
HK-5/64	5/64	1/8" I.D. Bearings (3-48 Screw)	\$0.83
HK-3/32*	3/32	3/16" I.D. Bearings (5-40 Screw)	\$0.83
HK-5/32	5/32	1/4" I.D. Bearings (10-32 Screw)	\$0.83

* Standard size fits most bits.



Base Plate Reducers

PART	DESCRIPTION	PRICE
9510	Base Plate Reducers	\$37.85

These solid brass inserts fit into your router base plate to reduce the hole around the router bit. Not only is this safer, but it also reduces tearout and helps support smaller workpieces. Supplied in a set with openings of 1/4", 3/8", 1/2", 5/8", 3/4", 7/8", and 1", plus retaining nut. Openings are slightly oversize for tool clearance. Fits any router with a standard 1 3/16" diameter recessed hole for template guides.



WHITESIDE MACHINE

Shim Washer Set

PART	DESCRIPTION	PRICE
W300	Shim Washer Set	\$10.01

Use these shim washers to fine adjust the spacing on Stile and Rail Bits or on any assembly with a 5/16" diameter arbor. Washers are 5/16" I.D. x 1/2" O.D. Includes three each of the following thicknesses: .004, .006, .008, .010 and .012.

Quick Change Chuck

PART	DESCRIPTION	PRICE
9700	All 1/2" Porter-Cable (Except 100)	\$73.42
9710	All 1/2" Bosch	\$73.42
9720	Dewalt 625/Elu 1/2" Festool/Freud	\$73.42
9730	Dewalt 616, 618 and 621	\$73.42

Swap router bits quickly and easily. Cam-lock design clamps and loosens with a partial turn using a hex-key wrench. Much simpler than the two wrench method. Holds 1/2" shank bits. Use router collets for smaller shanks.



Brass Set-Up Gauge Blocks

PART	DESCRIPTION	PRICE
9800	5 Piece Set (2-1/2" Long)	\$9.86
9810	5 Piece Set (4" Long)	\$14.34

Our square gauge blocks are a quick way to make many easy, accurate set-ups. A great way to make exact depth movements on plunge routers. On table routers, they're perfect for setting distances from the fence to the cutter, or for checking the bit height above the table. Supplied in 1/8", 3/16", 1/4", 3/8" and 1/2" squares.

Blocks can be "stacked" to cover a wide range of sizes. A very helpful tool!

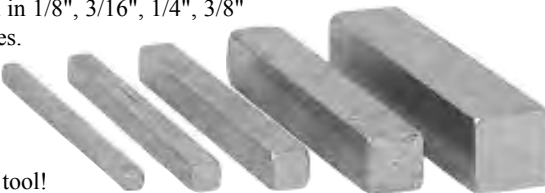

Bearing Lock Collars

PART	SHANK DIAMETER	OUTSIDE DIAMETER	PRICE
LC-1/4	1/4	7/16	\$2.72
LC-1/2	1/2	11/16	\$2.72

Uses part HK-1/16 Hex Key Wrench
LCS-Replacement Set Screws for Lock Collars
Retaining Collars used when bearings are added to the shanks of router bits for following templates.



Ball Bearings



PART	OUTSIDE DIA.	INSIDE DIA.	APPLICATION	PRICE
B1A	1/4	1/8		\$5.00
B1	3/8	1/8		\$4.17
B2	3/8	3/16		\$3.76
B3	1/2	3/16	Standard	\$3.76
B3 BLK	1/2	3/16	100 pcs. bulk	\$271.15
B3S	1/2	3/16	Non-Mar Nylon Sleeve	\$6.89
B3T	1/2	3/16	Teflon® Shields	\$4.59
B3U	.490	3/16	for resharpening (undersize)	\$4.59
B4	3/4	1/4		\$3.34
B5	7/8	5/16		\$3.34
B6	5/8	1/4		\$3.34
B7	5/8	3/16		\$3.67
B8	3/4	3/16		\$5.00
B9	1/2	1/4		\$4.17
B9U	.490	1/4	for resharps (undersize)	\$6.26
B11	1-1/8	1/2		\$4.17
B12	7/8	3/8		\$6.68
B13 NEW	7/8	1/2		\$8.76
B14	11/16	3/16		\$7.10
B15	13/16	3/16		\$7.93
B16	1-1/4	1/2		\$13.35
B17	1-3/8	1/2		\$13.35
B18	1-1/2	1/2		\$13.35
B19	3/4	1/2		\$10.43
B20	3/4	5/16		\$8.34
B21	7/8	1/4		\$11.68
B24	1-7/8	1/2		\$15.86
B25	1-1/8	5/16		\$12.52
B26	1-3/8	5/16		\$12.52
B27	5/8	5/16		\$7.51
B28	7/8	3/16		\$9.18
B29	1	3/16		\$9.18
B33 NEW	9/16	3/16		\$10.01
BB300	7/8 x 10°	3/16	Non-Mar Nylon Sleeve	\$15.77

Euro Square Bearings

PART	INSIDE DIAMETER	SIZE	PRICE
B3SQ	3/16	1/2	\$5.42
B8SQ	3/16	3/4	\$5.42

Replace the standard 1/2" B3 bearing found on most of our Edge Form bits with the B3SQ square bearing if residue build-up on the bearing or marring of the workpiece is a problem. Recommended for solid surface applications.



Extension Adapter for CNC Carving Machines

PART	DESCRIPTION	PRICE
9750	Extension Adapter for CNC Carving Machines	\$43.38

Used for light routing and veining on CNC carving machines. Allows deeper reach. Adapter is 1/2" shank. Accepts 1/4" shank bits only.



WHITESIDE MACHINE

5 Piece Bearing Conversion Kit

PART	DESCRIPTION	PRICE
BB501	5 Piece Bearing Conversion Kit	\$12.52

Use this kit to change cutting depths or finish profile depth on tools with bearing pilots. Also great for stepping in to finish depth by controlled increments.

Contains: B2 (3/8"), B3 (1/2"), B7 (5/8"), B8 (3/4") Bearings and 3/32" Hex Key Wrench.

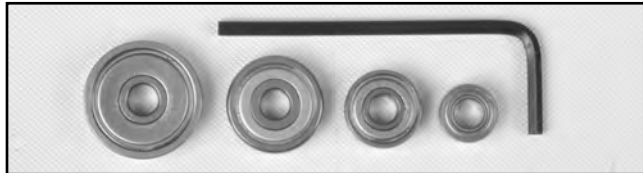

General Bearing Repair Kit

PART	DESCRIPTION	PRICE
BB600	General Bearing Repair Kit	\$17.52

This handy kit includes spare bearings, screws, and wrench to replace bearings on most bits. Includes five B3 (1/2 x 3/16) and two B2 (3/8 x 3/16) bearings, ten 54025S Screws, and a 3/32 Hex Key Wrench.

Accessory Kit

PART	DESCRIPTION	PRICE
BB701	Accessory Kit	\$40.05

Great for replacement bearings and screws - plus this generous bearing assortment allows you to vary your cutting depths and change your profiles. Also contains lock collars and bearings for adding bearing guides to the shanks of your standard bits for following templates.

Contains: 12 bearings - four B3 (1/2" x 3/16"), one each of B2 (3/8" x 3/16"), B7 (5/8" x 3/16"), B8 (3/4" x 3/16"), B9 (1/2" x 1/4"), B6 (5/8" x 1/4"), B4 (3/4" x 1/4"), B5 (7/8" x 5/16"), and B11 (1-1/8" x 1/2"); two each 1/4" lock collars (LC-1/4) and 1/2" lock collars (LC-1/2); one each 1/16", 5/64", 3/32", and 5/32" Hex Key Wrenches; plus ten 54025S bearing screws.

Socket Head Cap Screws

PART	QUANTITY	THREAD SIZE	THREAD LENGTH	HEX KEY SIZE	PRICE
34825S	10	3 - 48	1/4	5/64	\$3.34
34825SBLK	100	3 - 48	1/4	5/64	\$20.03
54025S	10	5 - 40	1/4	3/32	\$3.34
54025SBLK	100	5 - 40	1/4	3/32	\$20.03
103238S	10	10 - 32	3/8	5/32	\$3.34
103238SBLK	100	10 - 32	3/8	5/32	\$20.03



Hex Nuts - 10 Piece Pack

PART	THREAD SIZE	WIDTH	HEX SIZE	PRICE
1032N	10 - 32	1/4	3/8	\$4.17
5020N	1/2 - 20	7/16	3/4	\$5.00
31224N	5/16 - 24	1/4	1/2	\$4.17

Flat Washers - 10 Piece Pack

PART	INSIDE DIAMETER	OUTSIDE DIAMETER	THICKNESS	PRICE
31250W	5/16	1/2	1/16	\$6.68
5088W	1/2	7/8	5/64	\$8.35

Replacement Parts by Tool Number

PART	ITEM	WORKS FOR TOOL S	PRICE
34825S	Screw	2400, 2401, 2404A	\$3.34
103238S	Screw	2013 thru 2016, 2410, 2560, 2570, 2575, 2580, 2900, 2908, 3390	\$3.34
1032N	Nut	RFT5125, RFTD5125, RFT5200, RFTD5200, UDFT5152	\$4.17

Replacement Bearing sizes are listed in the catalog with each tool. Most tools with bearing pilots on the end require only the 54025S Screw. Listed above are known exceptions.

Raised Panel Sets - 1/2" Shank

PART	INCLUDES	INCLUDED ITEM DESCRIPTION	PRICE
100	6001 6000A	Round Stile and Rail Standard Raised Panel	\$185.40
101	6002 6000C	Ogee Stile and Rail Ogee Raised Panel	\$185.40
120	5920B 6001	Bevel Raised Panel w/ Back Cutter Round Stile and Rail	\$189.26
121	5920C 6002	Ogee Raised Panel w/ Back Cutter Ogee Stile and Rail	\$189.26

WHITESIDE MACHINE

Straight and Half Round Combo 1/2" Shank

PART	INCLUDES	PRICE
600	3/8" Straight, 3/8" Half Round 1/2" Straight, 1/2" Half Round 5/8" Straight, 5/8" Half Round 3/4" Straight, 5/8" Half Round	\$181.44

A nice collection of Straight Bits and Half Rounds grouped together in one protective case. This handy group covers the full assortment of bits needed for the INCRA® HingeCrafter. Whiteside Industrial Quality.



Roundover and Beading Set 1/2" Shank

PART	DESCRIPTION	PRICE
501	Roundover and Beading Set 1/2" Shank	\$95.04

Roundovers are by far the most used Edge forming bits in wood-working. This set offers the most common Radii (1/4", 3/8" and 1/2") in 1/2" shanks, plus a hefty 3/4" Radius workhorse. Extra bearings and wrench are included to convert each bit from Rounding over to Beading - i.e., Roundover with a decorative step.



Basic 7 Piece Router Bit Set

PART	SHANK DIAMETER	PRICE
401	1/2	\$95.04
402	1/4	\$95.04

These sets are made up of the most popular woodworking bits. Included are 1/4" Straight, 1/2" Straight, 3/8" Radius Roundover, 3/8" x 1/2" Rabbet, 3/8" Radius Cove, 45° Chamfer and a 1/2" Flush Trim. All USA Quality.

Roundover and Beading Set 1/4" Shank

PART	DESCRIPTION	PRICE
502	Roundover and Beading Set 1/4" Shank	\$95.04

Easily round off all your square edges with lightweight 1/4" capacity Hand Routers. Keep the whole range of sizes (R1/8, R3/16, R1/4, R3/8 and R1/2) neatly organized and right at your fingertips.

As with the 1/2" shank set, this kit comes fully equipped to extend its usage by converting to Beading - i.e., Roundover with a decorative step.



The Ten Essential Router Bits Set

PART	DESCRIPTION	PRICE
410	10 Essential Router Bits	\$223.78

- Made from solid alloy steel
- Precision ground for proper balance at high RPMs.
- Uses the highest quality American made micrograin carbide.
- High hook and relief angles make for better chip ejection.
- Made with thick carbide for extra sharpenings.
- Superior edge quality.
- Made with only the high quality American made grinding wheels.



WHITESIDE MACHINE



Single Flute - Up/ Down DOOR-LITE Bit

Designed for Metal Clad Doors

PART	CED	CEL	SHK DIA	OAL	PRICE
HC 5250	1/2"	2-1/2"	1/2"	5-1/2"	\$36.71
HCF 5250	With Flat on Shank				\$38.38

BIT SET 703

Solid Carbide Conical 1/16" Taper Bit - 4 Flute

PART	BALL NOSE BIT	RADIUS	DEGREE	SHANK	CUT LENGTH	VER ALL LENGTH	PRICE
SC 66	1/8"	1/16"	7.2	1/4"	3/4"	2-1/2"	\$43.20

Solid Carbide Two Flute Spiral with Ball End (Round Nose)

PART	BALL NOSE BIT	RADIUS	SHANK	CUT LENGTH	VER ALL LENGTH	PRICE
RU1800RN	3/16"	3/32"	1/4"	3/4"	2-1/2"	\$21.00
RU2075RN	1/4"	1/8"	1/4"	3/4"	2-1/2"	\$19.50

Price For Set: \$74.85



703

BIT SET 705

Solid Carbide Conical 1/16" Taper Bit - 4 Flute

PART	BALL NOSE BIT	RADIUS	DEGREE	VER ALL LENGTH	PRICE
SC 66	1/8"	1/16"	7.2	2-1/2"	\$43.20

Solid Carbide Conical 1/32" Taper Bit - 4 Flute

PART	BALL NOSE BIT	RADIUS	DEGREE	VER ALL LENGTH	PRICE
SC 64	1/16"	1/32"	11	2-1/2"	\$43.20

Solid Carbide Two Flute Spi

PART	CUT DIAMETER	CUT LENGTH	PRICE
RU2075	1/4"	3/4"	\$15.65

90 Degree Vee Groove

PART	CUT DIAMETER	POINT LENGTH	PRICE
1502	1/2"	1/4"	\$17.52

60 Degree Vee Groove

PART	CUT DIAMETER	POINT LENGTH	PRICE
1550	1/2"	7/16"	\$18.35

Price For Set: \$121.80



705



706

BIT SET 706

Part #	PCS	Description	Price
706	6	Lettering Set - 1403, 1404, 1550, 1572, 2051, and RU2075CN	\$111.00

WHITESIDE MACHINE

Brad Point Dowel Drills Carbide Tipped - 10mm Shank Import (RH + LH)

CUTTING DIA.	57mm OAL PART RH	PART LH	PRICE
3/16	DB187-57RH	DB187-57LH	\$10.83
7/32	DB218-57RH	DB218-57LH	\$10.83
1/4	DB250-57RH	DB250-57LH	\$10.83
5mm	DB5-57RH	DB5-57LH	\$10.83
6mm	DB6-57RH	DB6-57LH	\$10.83
7mm	DB7-57RH	DB7-57LH	\$8.38
8mm	DB8-57RH	DB8-57LH	\$8.94
9mm	DB9-57RH	DB9-57LH	\$8.94
10mm	DB10-57RH	DB10-57LH	\$8.94
11mm	DB11-57RH	DB11-57LH	\$10.15
12mm	DB12-57RH	DB12-57LH	\$9.77
13mm	DB13-57RH	DB13-57LH	\$10.15
14mm	DB14-57RH	DB14-57LH	\$10.81
15mm	DB15-57RH	DB15-57LH	\$10.48
16mm	DB16-57RH	DB16-57LH	\$10.81
3mm*	DB3-57SCRH	DB3-57LHSC	\$18.15
4mm	DB4-57SCRH	DB4-57LHSC	\$16.82
5mm	DB5-57SCRH	DB5-57LHSC	\$17.34

RH and LH rotation. Include LH suffix for left hand rotation. Include SC suffix for Solid Carbide (Prices differ between SC and non-SC drills Call for pricing). Supplied with flat on shank. * 3mm available in Solid Carbide Only.



Thru Hole V-Point Dowel Drills Carbide Tipped - 10mm Shank - Import (RH + LH)

CUTTING DIA.	57mm OAL PART RH	PART LH	PRICE
1/4	DT250-57RH	DT250-57LH	\$15.08
5mm	DT5-57RH	DT5-57LH	\$11.16
6mm	DT6-57RH	DT6-57LH	\$13.14
7mm	DT7-57RH	DT7-57LH	\$14.70
8mm	DT8-57RH	DT8-57LH	\$15.21
9mm	DT9-57RH	DT9-57LH	\$20.16
10mm	DT10-57RH	DT10-57LH	\$19.80
11mm	DT11-57RH	DT11-57LH	\$24.84
12mm	DT12-57RH	DT12-57LH	\$24.84
13mm	DT13-57RH	DT13-57LH	\$25.88
14mm	DT14-57RH	DT14-57LH	\$27.00
15mm	DT15-57RH	DT15-57LH	\$27.00

Brad Point Dowel Drills Carbide Tipped - 10mm Shank Import (RH + LH)

CUTTING DIA.	70mm OAL PART RH	PART LH	PRICE
3/16	DB187-70RH	DB187-70 LH	\$11.67
7/32	DB218-70RH	DB218-70 LH	\$11.67
1/4	DB250-70RH	DB250-70 LH	\$11.67
3/8	DB375-70RH	DB375-70 LH	\$9.86
7/16	DB437-70RH	DB437-70 LH	\$10.98
1/2	DB500-70RH	DB500-70 LH	\$10.98
5mm	DB5-70RH	DB5-70 LH	\$8.85
6mm	DB6-70RH	DB6-70 LH	\$8.85
7mm	DB7-70RH	DB7-70 LH	\$9.03
8mm	DB8-70RH	DB8-70 LH	\$9.86
9mm	DB9-70RH	DB9-70 LH	\$10.06
10mm	DB10-70RH	DB10-70 LH	\$10.06
11mm	DB11-70RH	DB11-70 LH	\$10.98
12mm	DB12-70RH	DB12-70 LH	\$10.98
13mm	DB13-70RH	DB13-70 LH	\$10.98
14mm	DB14-70RH	DB14-70 LH	\$11.88
15mm	DB15-70RH	DB15-70 LH	\$11.88
16mm	DB16-70RH	DB16-70 LH	\$11.88
3mm*	DB3-70SCRH	DB3-70LHSC	\$19.66
4mm	DB4-70SCRH	DB4-70LHSC	\$18.15
5mm	DB5-70SCRH	DB5-70LHSC	\$17.83

Thru Hole V-Point Dowel Drills Carbide Tipped - 10mm Shank-Import (RH + LH)

CUTTING DIA.	70mm OAL PART RH	PART LH	70mm PRICE
3/16	DT187-70RH	DT187-70LH	\$15.75
7/32	DT218-70RH	DT218-70LH	\$16.05
1/4	DT250-70RH	DT250-70LH	\$16.05
3/8	DT375-70RH	DT375-70LH	\$24.12
7/16	DT437-70RH	DT437-70LH	\$26.10
1/2	DT500-70RH	DT500-70LH	\$30.96
5mm	DT5-70RH	DT5-70LH	\$12.49
6mm	DT6-70RH	DT6-70LH	\$14.15
7mm	DT7-70RH	DT7-70LH	\$15.03
8mm	DT8-70RH	DT8-70LH	\$16.47
9mm	DT9-70RH	DT9-70LH	\$19.96
10mm	DT10-70RH	DT10-70LH	\$19.96
11mm	DT11-70RH	DT11-70LH	\$26.10
12mm	DT12-70RH	DT12-70LH	\$24.75
13mm	DT13-70RH	DT13-70LH	\$29.95
14mm	DT14-70RH	DT14-70LH	\$30.78
15mm	DT15-70RH	DT15-70LH	\$34.92

RH and LH rotation. Include LH suffix for left hand rotation. Include SC suffix for Solid Carbide (Prices differ between SC and non-SC drills Call for pricing). Supplied with flat on shank.

* 3mm available in Solid Carbide Only.



WHITESIDE MACHINE

**Hinge Boring Bits - Carbide Tipped
10mm Shank-Import**

CUTTING DIAMETER	57mm OAL PART	57mm PRICE	70mm OAL PART	70mm PRICE
15mm	DH15-57LH	\$24.04	DH15-70LH	\$24.74
20mm	DH20-57	\$24.54	DH20-70LH	\$25.25
25mm	DH25-57LH	\$25.13	DH25-70LH	\$25.84
30mm	DH30-57LH	\$26.55	DH30-70LH	\$28.89
35mm	DH35-57LH	\$26.82	DH35-70LH	\$29.52

RH and LH rotation. Include LH suffix for left hand rotation. Supplied with flat on shank.



Steel Router Collets - Reducer Bushings

PART	I.D.	O.D.	OVERALL LENGTH	PRICE
6400	1/4	1/2	1-1/4	\$10.43
6400x8	8mm	1/2	1-1/4	\$10.43
6401	5/16	1/2	1-1/4	\$10.43
6402	3/8	1/2	1-1/4	\$10.43
6403	1/4	3/4	1-1/4	\$15.02
6404	5/16	3/4	1-1/4	\$15.02
6405	3/8	3/4	1-1/4	\$15.02
6406	1/2	3/4	1-1/4	\$12.52



15° - Engraving Bits



SC54 SC55

30° - Engraving Bits

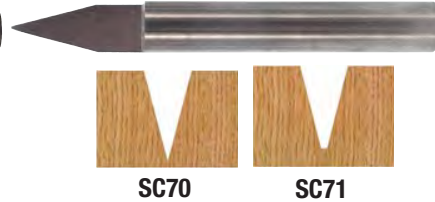

SC70 SC71

45° - Engraving Bits



SC75 SC76

Part #	Point Type	Included Angel	OAL	Price
SC75	Pencil	45°	2	\$21.63
SC76	1/32 Flat	45°	2	\$21.63
SC70	Pencil	30°	2	\$23.18
SC71	1/32 Flat	30°	2	\$23.18
SC54	1/16 Flat	15°	2-1/2	\$23.18
SC55	3/32 * 45°	15°	2-1/2	\$24.72

Laminate Roundover

No Filing Bits



2630



2631

Part #	Radius	Bearing	Shank Dia	Price
2630	1/16	Standard	1/4	\$ 21.00
2631	1/16	Square	1/4	\$ 24.00

Transom Drill - 8 OAL/Quick Change Chank

Part #	Dia	Twist Length	OAL	Recommended Rev/Min	Price
8040437	7/16	6	8	2000-3000	\$ 64.00
8040500	1/2	6	8	2000-3000	\$ 64.00
8040531	17/32	6	8	2000-3000	\$ 64.00
8040562	9/16	6	8	2000-3000	\$ 64.00
8040687	11/16	6	8	2000-3000	\$ 67.20
8040937	15/16	6	8	2000-3000	\$ 76.80

Transom Drill - 5 OAL/Quick Change Chank

Part #	Dia	Twist Length	OAL	Recommended Rev/Min	Price
8050375	3/8	3-3/4	5	2000-3000	\$ 59.20
8050500	1/2	3-3/4	8	2000-3000	\$ 59.20
8050562	9/16	3-3/4	5	2000-3000	\$ 59.20
8050750	3/4	3-3/4	5	2000-3000	\$ 68.80
8051000	1	3-3/4	5	2000-3000	\$ 75.20

Brad Point Transom Drill - 5 OAL/Quick Change Chank

Part #	Dia	Twist Length	OAL	Recommended Rev/Min	Price
8100312	5/16	3-3/4	5	2000-3000	\$ 68.80
8100375	3/8	3-3/4	8	2000-3000	\$ 68.80
8100500	1/2	3-3/4	5	2000-3000	\$ 68.80
8100562	9/16	3-3/4	5	2000-3000	\$ 68.80

Composite Drills - With Pilot Drill**3-7/8 OAL/Carbide Tipped/Quick Change Shank**

Part #	Size	Recommended Rev/Min	Depth of Cut	Price
8090750	3/4	2500-3000	3-7/8	\$ 72.00
8090937	15/16	2200-2800	3-7/8	\$ 72.00
8091000	1	2200-2800	3-7/8	\$ 72.00
8091062	1-1/16	2200-2800	3-7/8	\$ 81.60
8091125	1-1/8	2000-2500	3-7/8	\$ 81.60
8091187	1-3/16	2000-2500	3-7/8	\$ 89.60
8091250	1-1/4	2000-2500	3-7/8	\$ 89.60
8091312	1-5/16	2000-2500	3-7/8	\$ 97.60
8091500	1-1/2	2000-2500	3-7/8	\$ 104.80
8091750	1-3/4	2000-2500	3-7/8	\$ 108.80



3-Wing Drills - 6" Overall Length

Part #	Size	Shank Dia	Nominal Overall Length	Price
8120687	11/16	1/2	6	\$ 72.00
8120750	3/4	1/2	6	\$ 72.00
8120812	13/16	1/2	6	\$ 72.00
8120875	7/8	1/2	6	\$ 73.60
8121000	1	1/2	6	\$ 73.60
8121125	1-1/8	1/2	6	\$ 76.80
8121250	1-1/4	1/2	6	\$ 84.80
8121375	1-3/8	1/2	6	\$ 92.80
8121500	1-1/2	1/2	6	\$ 100.00
8121625	1-5/8	1/2	6	\$ 102.40
8121750	1-3/4	1/2	6	\$ 104.00
8121875	1-7/8	1/2	6	\$ 123.20
8122000	2	1/2 *	6	\$ 124.80
8122125	2-1/8	1/2 *	6	\$ 124.80
8122250	2-1/4	1/2 *	6	\$ 144.00
8122500	2-1/2	1/2 *	6	\$ 152.00



* Sizes 2" and larger have 1/2 shank with a 3/4 diameter reinforced step

Quick Change Tooling - Quick Change Chucks



Part #	Shank Size	Adapter Size	OAL	Price
8020375	3/8 Hex	7/16 Hex	2-3/4	\$ 36.00
8020500	1/2 Hex	7/16 Hex	2-3/4	\$ 28.80

1/4 Hex Adapter



Part #	Shank Size	Adapter Size	OAL	Price
8020250	7/16 Hex	1/4 Hex	2-1/8	\$ 24.00

Quick Change Shank



Part #	Shank	Shank Length	Price
800/QCS	7/16 Hex	2	\$ 9.60
800-3/QCS	7/16 Hex	3	\$ 12.00
800-4/QCS	7/16 Hex	4	\$ 14.40
800-6/QCS	7/16 Hex	5	\$ 19.20

3-Wing Composite Drills**3-7/8 OAL/Carbide Tipped/Quick Change Shank**

Part #	Size	Recommended Rev/Min	OAL	Price
8030500	1/2	2500-3000	3-7/8	\$ 67.20
8030562	9/16	2500-3000	3-7/8	\$ 67.20
8030625	5/8	2500-3000	3-7/8	\$ 67.20
8030687	11/16	2500-3000	3-7/8	\$ 67.20
8030750	3/4	2500-3000	3-7/8	\$ 67.20
8030812	13/16	2200-2800	3-7/8	\$ 67.20
8030875	7/8	2200-2800	3-7/8	\$ 67.20
8030937	15/16	2200-2800	3-7/8	\$ 67.20
8031000	1	2200-2800	3-7/8	\$ 67.20
8031062	1-1/16	2000-2500	3-7/8	\$ 73.60
8031125	1-1/8	2000-2500	3-7/8	\$ 76.80
8031250	1-1/4	2000-2500	3-7/8	\$ 84.80
8031312	1-5/16	2000-2500	3-7/8	\$ 89.60
8031375	1-3/8	2000-2500	3-7/8	\$ 89.60
8031437	1-7/16	2000-2500	3-7/8	\$ 96.00
8031500	1-1/2	2000-2500	3-7/8	\$ 100.00
8031625	1-5/8	2000-2500	3-7/8	\$ 102.40
8031750	1-3/4	2000-2500	3-7/8	\$ 104.00
8031875	1-7/8	2000-2500	3-7/8	\$ 112.00
8032000	2	1800-2300	3-7/8	\$ 124.80
8032125	2-1/8	1500-2000	3-7/8	\$ 132.80
8032250	2-1/4	1500-2000	3-7/8	\$ 144.00
8032500	2-1/2	1500-2000	3-7/8	\$ 152.00

**Deep-Cor Hole Saw - Carbide Tipped**

Part #	Size	Recommended Rev/Min	Depth of Cut	Price
8081125K	1-1/8	1800-2300	3	\$ 119.76
8081187K	1-3/16	1800-2300	3	\$ 119.76
8081500K	1-1/2	1800-2300	3	\$ 130.80
8081625K	1-5/8	1800-2300	3	\$ 146.40
8081750K	1-3/4	1800-2300	3	\$ 146.40
8081875K	1-7/8	1800-2300	3	\$ 151.20
8082125K	2-1/8	1800-2300	3	\$ 168.00
8082250K	2-1/4	1800-2300	3	\$ 168.00
8082312K	2-5/16	1800-2300	3	\$ 180.00
8082375K	2-3/8	1800-2300	3	\$ 180.00
8082500K	2-1/2	1800-2300	3	\$ 180.00
8083000K	3	1500-2000	3	\$ 208.80
8083250K	3-1/4	1500-2000	3	\$ 226.80
8083500K	3-1/2	1500-2000	3	\$ 226.80
8083625K	3-5/8	1500-2000	3	\$ 252.00
8084000K	4	500-1200	3	\$ 288.00
8084125K	4-1/8	500-1200	3	\$ 288.00
8084375K	4-3/8	500-1200	3	\$ 316.80
8084625K	4-5/8	500-1200	3	\$ 336.00
8084750K	4-3/4	500-1200	3	\$ 336.00
8086625K	6-5/8	500-1200	3	\$ 456.00

Self Clean Hole Saw - Carbide Tipped



Part #	Size	Recommended Rev/Min	Price
8001000K	1	1800-2300	\$ 79.84
8001062K	1-1/16	1800-2300	\$ 79.84
8001125K	1-1/8	1800-2300	\$ 79.84
8001187K	1-3/16	1800-2300	\$ 79.84
8001250K	1-1/4	1800-2300	\$ 79.84
8001312K	1-5/16	1800-2300	\$ 87.20
8001375K	1-3/8	1800-2300	\$ 87.20
8001437K	1-7/16	1800-2300	\$ 87.20
8001500K	1-1/2	1800-2300	\$ 87.20
8001625K	1-5/8	1800-2300	\$ 97.60
8001687K	1-11/16	1800-2300	\$ 97.60
8001750K	1-3/4	1800-2300	\$ 97.60
8001875K	1-7/8	1800-2300	\$ 100.80
8001937K	1-15/16	1800-2300	\$ 100.80
8001968K	1-31/32	1800-2300	\$ 100.80
8002000K	2	1800-2300	\$ 100.80
8002062K	2-1/16	1800-2300	\$ 112.00
8002125K	1-1/8	1800-2300	\$ 112.00
8002187K	2-3/16	1800-2300	\$ 112.00
8002250K	2-1/4	1800-2300	\$ 112.00
8002312K	2-5/16	1800-2300	\$ 120.00
8002375K	2-3/8	1800-2300	\$ 120.00
8002500K	2-1/2	1800-2300	\$ 120.00
8002625K	2-5/8	1800-2300	\$ 132.00
8002750K	2-3/4	1800-2300	\$ 132.00
8002875K	2-7/8	1800-2300	\$ 139.20
8003000K	3	1500-2000	\$ 139.20
8003125K	3-1/8	1500-2000	\$ 151.20
8003250K	3-1/4	1500-2000	\$ 151.20
8003437K	3-7/16	1200-1800	\$ 151.20

Part #	Size	Recommended Rev/Min	Price
8003500K	3-1/2	1200-1800	\$ 151.20
8003625K	3-5/8	1200-1800	\$ 168.00
8003687K	3-11/16	800-1200	\$ 168.00
8003750K	3-3/4	800-1200	\$ 168.00
8003875K	3-7/8	800-1200	\$ 168.00
8004000K	4	500-1200	\$ 192.00
8004125K	4-1/8	500-1200	\$ 192.00
8004250K	4-1/4	500-1200	\$ 192.00
8004312K	4-5/16	500-1200	\$ 211.20
8004375K	4-3/8	500-1200	\$ 211.20
8004500K	4-1/2	500-1200	\$ 211.20
8004625K	4-5/8	500-1200	\$ 224.00
8004750K	4-3/4	500-1200	\$ 224.00
8005000K	5	500-1200	\$ 236.00
8005250K	5-1/4	500-1200	\$ 248.00
8005312K	5-5/16	500-1200	\$ 256.00
8005500K	5-1/2	500-1200	\$ 256.00
8005625K	5-5/8	500-1200	\$ 272.00
8005750K	5-3/4	500-1200	\$ 272.00
8006000K	6	500-1200	\$ 280.00
8006250K	6-1/4	500-1200	\$ 288.00
8006375K	6-3/8	500-1200	\$ 300.00
8006500K	6-1/2	500-1200	\$ 300.00
8006625K	6-5/8	500-1200	\$ 304.00
8006875K	6-7/8	500-1200	\$ 340.00
8007250K	7-1/4	500-1200	\$ 380.00
8008375K	8-3/8	500-1200	\$ 580.00
8008500K	8-1/2	500-1200	\$ 580.00
8008625K	8-5/8	500-1200	\$ 600.00

Self-Centering VIX Bits - 1/4" Shank



Replacement Drill Bits

Part #	Size	Description	Price
8110003	5/64	#3 & #4 Wood Screw	\$ 11.20
8110005	7/64	#5 & #6 Wood Screw	\$ 11.20
8110008	9/64	#8, #9 & #10 Wood Screw	\$ 11.20
8110012	11/64	#12 Wood Screw	\$ 28.80
8110014	13/64	#14 Wood Screw	\$ 28.80
8110051	5 mm	5 mm Shelf Pin - 3/8 Pilot	\$ 24.00
8110025	1/4	1/4 Shelf Pin - 3/8 Pilot	\$ 24.00

Part #	Size	Description	Price
8110783	5/64	Replacement Bit	\$ 3.20
8111095	7/64	Replacement Bit	\$ 3.20
8111418	9/64	Replacement Bit	\$ 3.20
8111712	11/64	Replacement Bit	\$ 4.80
8112014	13/64	Replacement Bit	\$ 4.80
8115051	5 mm	Replacement Bit	\$ 4.80
8112525	1/4	Replacement Bit	\$ 4.80

MOLDING STEEL

ALL BARS 25" LONG

High Speed Steel Corrugated Knives 35° Bevel

PART	WIDTH	THICKNESS	CORRUGATIONS	PRICE
SCM25125	1-1/4	1/4	16-60	\$86.96
SCM25150	1-1/2	1/4	16-60	\$94.92
SCM25175	1-3/4	1/4	16-60	\$101.45
SCM25200	2	1/4	16-60	\$105.98
SCM225	2-1/4	1/4	16-60	\$111.87
SCM25250	2-1/2	1/4	16-60	\$118.32
SCM31125	1-1/4	5/16	16-60	\$94.84
SCM31150	1-1/2	5/16	16-60	\$104.22
SCM31175	1-3/4	5/16	16-60	\$112.31
SCM31200	2	5/16	16-60	\$116.79
SCM31225	2-1/4	5/16	16-60	\$125.17
SCM31250	2-1/2	5/16	16-60	\$134.91
SCM31275	2-3/4	5/16	16-60	\$140.54
SCM31300	3	5/16	16-60	\$159.38

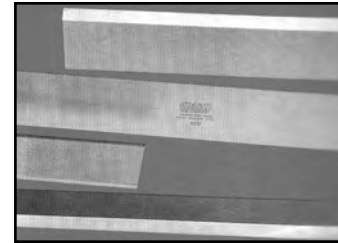

Lumber and wood working plants the world over specify M-2 High-Speed Steel knives to produce the finest finish cuts in planer, jointer, molder, and tenon operations. The consistent hardness and high molybdenum content give an excellent edge and allows for easy grinding. High-Speed Steel is ideal for medium to long runs.

Williams and Hussey Steel - Plain and Corrugated

ALL BARS 25" LONG

PART	WIDTH	THICKNESS	CORRUGATIONS	PRICE
WH13414	1-3/4	1/4	Plain Back	\$102.74
WH214	2	1/4	Plain Back	\$105.38
WH21414	2-1/4	1/4	Plain Back	\$113.13
WH21214	2-1/2	1/4	Plain Back	\$119.93
KA26383	1-3/4	3/16	16-60	\$112.58
KA26383C	2-1/4	1/4	16-60	\$120.34
KA26383C	2-1/2	1/4	16.60	\$127.13

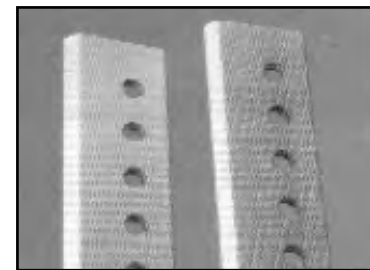

High Speed BEVEL EDGE Shaper Steel - 30° Bevel

High Speed Steel - Finish Ground Router Blanks - 3" Overall Length

PART	LENGTH	WIDTH	THICKNESS	PRICE
41254	25	3/4	5/16	\$64.99
41262	25	1-3/4	5/16	\$98.58
41266	25	2-1/4	5/16	\$118.13
41268	25	2-1/2	5/16	\$118.13
41270	25	2-3/4	5/16	\$134.72
41272	25	3	5/16	\$134.72

PART	WINGS	DIAMETER	EDGE	PRICE
63021	2	3/4	1-1/2	\$64.87
63022	2	1	1-1/2	\$64.87
63025	2	1-3/4	1-1/2	\$64.87
70519	2	2-3/4	1-1/2	\$132.74

CLOSEOUT PRICING ON ABOVE BEVEL EDGE SHAPER STEEL WHILE SUPPLIES LAST.

OTHER SIZES OF WKW STEEL ARE ALSO AVAILABLE.

Part Number	Diameter	Cutting Length	Price
SEHSSRB-34	3/4"	1-1/2"	\$41.66
SEHSSRB-1	1"	1-1/2"	\$45.28
SEHSSRB-1	1-1/4"	1-1/2"	\$52.70
SEHSSRB-112	1-1/2"	1-1/2"	\$65.24
SEHSSRB-134	1-3/4"	1-1/2"	\$75.20
SEHSSRB-2	2"	1-1/2"	\$76.40
SEHSSRB-214	2-1/4"	1-1/2"	\$92.33
SEHSSRB-212	2-1/2"	1-1/2"	\$115.20
SEHSSRB-234	2-3/4"	1-1/2"	\$120.83
SEHSSRB-3	3"	1-1/2"	\$127.19

Router blanks provide the flexibility to create you own designs.

**WILLIAMS & HUSSEY
MODEL 154CE**

ONLY \$2,195



**STRAIGHT
APPLICATION
SHOWN**



OPTIONAL VARI-FEED



SHOWN WITH
OPTIONAL MOBILE
BASE.

ALL MOLDER SPECS	MODELS 154CE, 206, 209
Machine Base	Steel Construction with levelers 28"L x 22"W x 33"H
Guide System	22"L x 11 3/4"W x 1/2"H, HDPE
Arbor RPMs	6900 (154CE & 206), 6960 (209)
Max. Profile Depth	3/4"
Min. Stock Length	9"
Max. Profile Width	6 3/4"
Min. Stock Thickness	1/4"
Max. Height Above Final Cut	3/16"
Max. Stock Thickness	7"
Planes	7" Wide
Overall Machine Dimensions	28"L x 22"W x 50"H
Working Height	35"
Package Weight	218 lbs

**ELLIPTICAL
APPLICATION
AS SHOWN**



SHOWN WITH
OPTIONAL
ELLIPTICAL JIG.

**WILLIAMS & HUSSEY
MODEL 206
ONLY \$2,795**



INDIVIDUAL MOLDER SPECS	MODEL 154CE	MODEL 206	MODEL 209
Feed Type	11 fpm, constant feed	0-19 fpm, variable feed	0-19 fpm, variable feed
Knife Motor	2 HP (3450 rpm)	2 HP (3450 rpm)	1 1/2" HP (3480 rpm)
Voltage	240V	240V	115V (20 amp required)
Phase	1	1 or 3	1

WILLIAMS & HUSSEY
MODEL 209
ONLY \$2,795



RADIUS APPLICATION SHOWN



20 AMP CIRCUIT
REQUIRED

6' EXTENSION
CORD.

SHOWN WITH
OPTIONAL MOBILE

**FREQUENTLY
ASKED QUESTIONS**

HOW DO I MAKE CONSTANT RADIUS MOLDINGS (ARCHES)?

W&H molders are designed to "cut" the profile into millable stock. For constant radius moldings you will need to make radius stock and matching guides. A router or bandsaw can be used to form the stock and guides.

WHY WOULD I WANT THE VARI-FEED OVER THE CONSTANT FEED MACHINE?

The vari-feed gives you more versatility. Different species of wood may cause problems with chip out, tear and other similar problems. The ability to vary the feed rate will minimize these problems.

I RUN A LOT OF STOCK, IS THIS MOLDER A PRODUCTION MACHINE?

Our molders are capable of running large quantities of stock day after day. Customers have referred to their molder as a workhorse, because they have run thousands of feet of molding through their molder.

CAN THE MOLDERS PERFORM STRAIGHT, CONSTANT RADIUS & ELLIPTICAL MOLDINGS?

Yes. All three models can perform straight and constant radius moldings. Add the elliptical jig to any molder to produce elliptical moldings, such as an oval or eyebrow shape. These shapes deviate from on radius to another requiring the elliptical jig.

WILLIAMS & HUSSEY VARI-FEED KITS

Our vari-feed kits give you the ability to vary the infeed roller speed from 0-19 fpm. The vari-feed kit will give you the opportunity to customize your feed setting to the work you are doing. It allows you to reduce the load on the motor while creating less stress on your stock. Higher rates of feed let you quickly run small profiles and casing reliefs.

The vari-feed kits are designed to fit on older W&H models; W7, W7PF, W7S, Original, 154 and 154CE Molders.

Item # VF-104-K \$775.00

Consists of a AC/DC control, vari-feed motor assembly, chains, sprockets and hardware. Your existing control will no longer be needed; this control will be used to start and stop both vari-feed and knife motors.



VF-104-K Shown

Item # VF-106-K \$585.00

Consists of a DC control, vari-feed motor assembly, control mounting bracket, chains, sprockets and hardware. Your existing control will be used to start and stop both vari-feed and knife motors.



VF-106-K Shown

Item # VF-105 \$62.00

Optional – 6' Extension Cord for Vari-Feeds

MULTI-PASS KIT

The longer springs and modified swing arm allow you to make cuts up to 3/16" above the finish cut height. Now you can raise the finish knife for a first cut on deep and/or wide profiles. This eliminates the need for a separate first cut knife or a dado cut on your saw, saving you time and money while providing you with a safe operation.

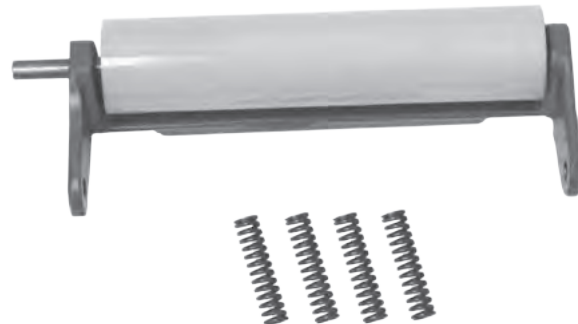

The multi-pass kits are designed to fit on older W&H models; W7, W7PF, W7S, Original and 154 molders.

Note: As of March 2005 our multi-pass system became a standard feature on all molders. Not sure if your machine has multi-pass? Call us with your serial # and we can assist you.

Item # MP-06-Yellow-K. \$99.00

Recommended for short runs, single passes and profiles with soft edges

Item # MP-06-Green-K. \$99.00

Recommended for long runs, multiple passes and profiles with sharp edges

CHIP EXTRACTOR & HEAD ASSEMBLY

Upgrade your W&H Molder Chip Deflector to the NEW Chip Extractor & Head Assembly. Replace the old cast iron & sheet metal with a Linear Low Density Polyethylene (LLDPE) Chip Extractor. Designed for better chip flow and completely covers knife area.



Assembly includes: Head, Chip Extractor, (2) Arbor Bearings, (4 of each) pressure screws, pressure springs, spring guides & check nuts.

Item # 54-520 \$350.00

WILLIAMS & HUSSEY

ELLIPTICAL JIG

Our elliptical jig can be attached to any of our molders. Looking for more than a standard arch cut? Attach the jig to produce elliptical moldings of architectural sizes to span doors and windows. Our jig is made with high grade steel, black oxidized and built to last!



Item # EJ-92 \$525.00

FEED ROLL KITS

Our polyurethane feed roll kits are available in “soft” 60 durometer and a “durable” 70 durometer. The yellow feed roll kit is commonly used for single pass applications. The green feed roll kit is commonly used for multiple pass applications. Choose the durometer that best fits your application use.

The kit includes 2 rollers, 4 axles to hold the rolls in and 1 tube of thread locker.



Item # P-123-K (2 yellow) \$99.00
 Recommended for short runs, single passes and profiles with soft edges

Item # P-170-K (2 green) \$99.00
 Recommended for long runs, multiple passes and profiles with sharp edges

GS-2-1 GUIDE SYSTEM

The GS-2-1 guide system increases your working surface and protects knives that may cut below stock thickness. Profiles such as crown bottoms, half rounds, quarter rounds and screen molds may cut below stock thickness.

The GS-2-1 guide system includes a 22” long, ½” thick HDPE, high density polyethylene millable material. The material is extremely tough and wear resistant with a low friction surface. The sub plate attaches directly to the bed of the molder with two screws. A flex guide, straight guide, adjusting handles and hardware are also included. The flex guide is beveled providing a wide entry for stock.



NOTE: Molder beds that do not have screw holes to attach the GS-2-1 will need to be modified. Item # GS-02 has instructions and the hardware needed to drill holes in the molder bed.

Item # GS-2-1 \$ 99.00
 Item # GS-02 (hardware bag for drilling holes) \$ 10.00

WILLIAMS & HUSSEY

Our molder stand is constructed from all steel and has been designed for easy assembly. Based on customer feed back the stand was redesigned in 2009 to be lighter, higher and more compact without sacrificing the strength and durability of our former stand. A motor lock was also added to prevent any unwanted movement while running stock. The angled leg design and padded levelers keep it secure to the floor for stability.

NOTE: If purchasing a stand to go with your existing molder, a 45" Powertwist Belt is required.

Add an optional mobile base for easy movement within your shop! See Mobile Base below.

Item # 54-402 \$325.00
 Item # 54-404 45" Red Powertwist Belt \$ 34.00

STAND (Stationary)



MOBILE BASE

Move your Williams & Hussey molder with ease with a rugged steel mobile base from Rockler. The 800 lb weight capacity and 5" urethane locking casters give you the ability to move your machine with little effort. The base provides you with adjustability from 18"x 18" to 28"x 28". Assembly required.

Item # 54-400 \$190.00



SHAPER HEADS

(For Extrema, Weinig, Wadkin, SCMI, Mikron, US Concepts and other Molders)

Now you can use your Williams & Hussey knives on a molder or shaper using one of these heads. Holes in knives must be able to accept 3/8" bolts – 4" heads made with a 1 1/4" bore and a 23° cutting angle. Heads with larger bores can be quoted on request.

Item #	Length	Diameter	Price
WH-404	4"	4"	\$295.00
WH-406	6"	4"	\$340.00



WH-404 Shown

WILLIAMS & HUSSEY CONTROLS

Our custom controls are built for professional use, day in and day out. They are designed to improve production and optimize efficiency, be reliable and maintenance free.

Controls & motors have to be rated the same phase & voltage. Our representatives will be able to assist you in this process if necessary.



54-417 Shown



54-413 Shown

Item #	Description	Model	Molder Control	Vari-Feed Control	Price US \$
54-421	Single Phase, 115V, AC/DC	209	✓	-	435.00
54-413	Single Phase, 240V, AC	154CE	✓	-	139.00
54-417	Single Phase, 240V, AC/DC	206	✓	-	413.00
54-420	Three Phase, 240V, AC/DC	206	✓	-	413.00
VF-35	Single Phase, 240V, DC	VF Kits	-	✓	225.00

KNIFE MOTORS

Our knife motors are designed with a high quality torque. They are constructed to operate with reduced vibration, minimal noise level and operate at maximum efficiency. The sturdy construction offers longer durability and minimum maintenance.

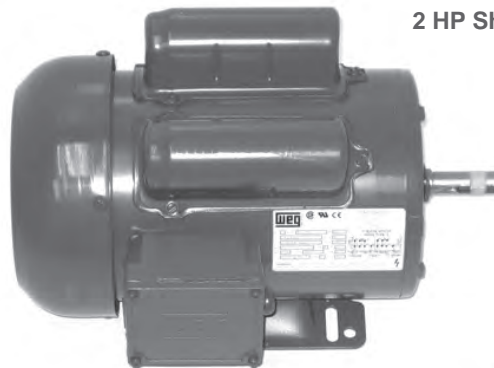

2 HP Shown

VARI-FEED MOTOR

Designed for demanding applications, higher performance, and higher standard of reliability. They operate quietly over the full range of speed. They are designed for longer more efficient life.

Item #	Description	Model	Knife Motor	Vari-Feed Motor	Price US \$
54-429	1 ½ HP, Single Phase	209	✓	-	210.00
54-430	2 HP, Single Phase	154CE,206	✓	-	315.00
54-431	2 HP, Three Phase	206	✓	-	315.00
VF-1	1/17 HP, Single Phase	206,209, VF Kits	-	✓	274.00



VF-1 Shown

WOODSTOCK

Steelex 25-Piece Deluxe Brad Point Set

Every woodworker needs this set. Twenty-five bits in sizes from 1/8" to 1/2" by 1/64" increments. Comes in a steel index.

D1034 \$21.60



D2140-29 pc. Cobalt Drill Set - 1/16 - 1/2"

These premium bits are engineered to handle high tensile steels and hard-to-machine alloys and are typically used in aerospace applications.

1/16" - 1/2" in 64ths

135° Split Point

D2140 \$146.00



Steelex Adjustable Circle Cutter

PART	DESCRIPTION	PRICE
D2251	Adjustable Circle Cutter	\$13.50
D2501	Set of Replacement Knives	\$3.80
D2502	Set of Replacement Center Points	\$2.40

Designed for use on a drill press, this fully Adjustable Circle Cutter will cut flat sided holes in wood from 1" to 5". Made of M-2 alloy steel, this Circle Cutter features a 3/8" hex shank, 5/16" drill, center point and Allen wrench. The perfect after-market accessory to any drill press



Steelex Large Saw-Toothed Forstner Bits

PART	SIZE	PRICE
D1017	2-1/4	\$22.70
D1018	2-5/16	\$24.60
D1019	2-3/8	\$25.40
D1020	2-1/2	\$25.30
D1021	2-5/8	\$28.70
D1022	2-3/4	\$29.80
D1023	2-7/8	\$31.80
D1024	3	\$33.40
D1025	3-1/8	\$35.00

These larger bits are production tools designed for use on a drill press. Large saw-toothed Forstner Bits have a 1/2" shank and measure 6 1/4" long. Each bit comes in an individual wooden box.

Steelex Carbide Tipped Forstner Bits

PART	SIZE	PRICE
D1026	35 mm	\$18.60

Steelex 8-Piece Set of Large Forstner Bits - Individually Boxed

This quality set includes 8 bits: 2-1/4", 2-3/8", 2-1/2", 2-5/8", 2-3/4", 2-7/8", 3" and 3-1/8". Bits are approximately 6-1/4" long and each bit comes in its own wooden box.

D1029 \$224.80



Steelex Forstner Bits

PART	SIZE	PRICE
D1001	1/4	\$3.00
D2846	5/16	\$4.80
D1002	3/8	\$3.30
D2847	7/16	\$5.40
D1003	1/2	\$3.80
D2848	9/16	\$5.90
D1004	5/8	\$4.40
D2849	11/16	\$6.60
D1005	3/4	\$4.90
D2850	13/16	\$7.30
D1006	7/8	\$5.30
D2851	15/16	\$7.70
D1007	1	\$5.60
D2852	1-1/16	\$8.90
D1008	1-1/8	\$6.30
D2853	1-3/16	\$9.90
D1009	1-1/4	\$7.20
D2854	1-5/8	\$10.70
D1010	1-3/8	\$8.30
D2855	1-7/16	\$11.20
D1011	1-1/2	\$8.90
D2856	1-9/16	\$12.20
D1012	1-5/8	\$9.50
D2857	1-11/16	\$13.30
D1013	1-3/4	\$10.00
D2858	1-13/16	\$14.50
D1014	1-7/8	\$10.20
D2859	1-15/16	\$15.60
D1015	2	\$12.60
D2860	2-1/16	\$16.80
D1016	2-1/8	\$13.70

We will stack our high quality Steelex Forstner Bits up against any bit in the world. In fact, an independent lab test proved that the Steelex brand cut was equal to or better than Forstner Bits from Austria, known for being the best. For use with drill presses.

For those that don't require the larger bit sizes, the 7-piece set offers bits up to 1". Made of High-Carbon Tool Steel, these bits are protected in a wooden case. This quality set includes 7 bits: 1/4", 3/8", 1/2", 5/8", 3/4", 7/8" and 1".



PART	Shank	Length	PRICE
D1027	3/8"	3-1/2"	\$19.80

Steelex 16-Piece Forstner Bit Set

This Forstner Bit Set is the standard in many cabinet and woodworking shops. The wide variety of sizes means always having the right bit ready and waiting. The larger bits from 1-1/8" to 2-1/8" are saw toothed style. The 16-Piece Forstner Bit Set comes in an attractive wooden case and includes 1/4", 3/8", 1/2", 5/8", 3/4", 7/8", 1", 1-1/8", 1-1/4", 1-3/8", 1-1/2", 1-5/8", 1-3/4", 1-7/8", 2", 2-1/8" diameter sizes. Each bit is approximately 3-1/2" long.

D1030 \$73.30





Flexible Hose Connector Pieces

PART	TYPE	SIZE	PRICE
W1011	Reducer	4 to 3	\$1.50
W1020	Reducer	3 to 2	\$1.30
W1037	Reducer	5 to 4	\$4.30
W1012	T Shape	3	\$4.20
W1013	T Shape	4	\$7.60
W1014	Shape	3	\$4.40
W1015	Shape	4	\$7.30
W1016	Elbow	3	\$4.40
W1017	Elbow	4	\$6.30
W1018	Splicer	3	\$2.00
W1019	Splicer	4	\$3.40
W1041	Adapter	2-1/2 x 3	\$1.30
W1042	Univeral Dust Port	2-1/2	\$3.90
W1044	Adapter	2-1/2 x 4	\$1.60

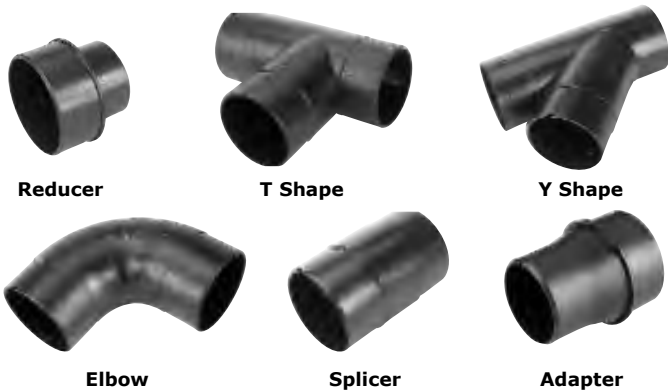

Floor Sweep

PART	O.D.	HEIGHT	PRICE
W1003	4	3-1/2	\$6.30



Universal Adapter

PART	OVERALL SIZE	PRICE
W1039	L x 6 W x 6 D	\$6.70

Seven-step adapter provides a multitude of dust collection reducing options. Simply cut away unneeded steps with a hacksaw. Outside diameter step sizes include 1", 2", 2-1/2", 3", 4", 5" and 6". Wall thickness is 1/8".



Wire Reinforced Clear Hose (Not Grounded)

PART	SIZE	PRICE
W1034	4" x 10	\$54.10
W1035	5" x 10	\$62.60
W1036	6" x 10	\$66.30



CLEAR HOSES DO NOT QUALIFY FOR THE FREE FREIGHT OFFER, REGARDLESS OF PURCHASE TOTAL.

Wire Hose Clamps

PART	SIZE	PRICE
W1315	2	\$0.54
W1316	3	\$0.64
W1317	4	\$0.84
W1318	5	\$0.84
W1319	6	\$0.94



Universal Dust Hood

PART	W1010
SIZE	6-1/4 x 6-1/4
THICKNESS	3-32
O.D.	4
FLANGE	3/4
PRICE	\$1.80

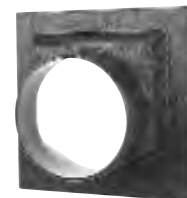

Table Saw Dust Hood

PART	SIZE	THICK	O.D.	FLANGE	PRICE
W1004	12-1/4 x 12-1/4 x 2-1/2	3/32	4	3/4	\$5.00
W1005	14 x 14 x 2-1/2	3/32	4	3/4	\$4.90

These hoods are designed to fit most 8", 10" and 12" contractor-type table saws, foreign and domestic.



Jointer Dust Hood

PART	SIZE	THICKNESS	O.D.	FLANGE	PRICE
W1001	8-1/4 x 8-1/4	3/32	4	3/4	\$2.30
W1002	8-1/2 x 10-1/4	3/32	4	3/4	\$2.80

W1001 fits over a 6-1/2 x 6-1/2 chute and the W1002 fits over a 7 x 8-1/2 chute.

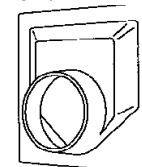

WOODSTOCK

ABS Plastic Blast Gates

PART	SIZE	PRICE
W1006	3	\$2.60
W1007	4	\$3.20
W1008	5	\$6.80
W1009	6	\$8.40



Aluminum Blast Gates

PART	SIZE	PRICE
W1141	3	\$9.00
W1142	4	\$12.50



Quick Disconnect

Designed to attach to the end of a 4" diameter dust hood for a quick and easy friction fit. Ideal for use with smaller capacity, mobile dust collectors to service multiple machines. Eliminates the need to connect and disconnect a hose clamp each time a new woodworking machine is used. Stays secure and airtight.

Material Thickness: 1/8"
 Small Outside Diameter: 3-7/8"
 Large Outside Diameter: 4-1/4"
 Length: 4"
 Weight: 21 lb



W1038 \$3.60

W2049 Mini Dust Collections Separator

Designed to be used with any 2" diameter Shop-Vac into a two-stage dust collection system. The Mini Dust collection Separator increases the capacity and efficiency of the typical Shop-Vac by allowing heavier particles to drop out of the system before they reach the main container. Finer particles can also be trapped by adding a small amount of water to the bottom of the bucket. Clean-ups are easy because the Mini Dust Collection Separator just lifts off of the bucket. The Mini Dust Collection Separator makes shop clean-up a breeze.



W2049 \$25.60

Hard Sanding Sleeve - 3 pk



Size	60 Grit	Price	80 Grit	Price	100 Grit	Price	120 Grit	Price	150 Grit	Price
1" * 4-1/4"	D2683	\$7.20	D2684	\$7.20	D2685	\$7.20	D2686	\$7.20	D2687	\$7.20
1-1/2" * 4-1/4"	D2688	\$7.80	D2689	\$7.80	D2690	\$7.70	D2691	\$7.80	D2692	\$7.70
2" * 4-1/4"	N/A		N/A		N/A		D2696	\$8.90	D2697	\$8.90

W2046 2-1/2" Hose Adapter

This fitting allows you to use our standard 2-1/2" dust collection hose with the Mini Dust Collection Separator, giving you many use options. A 2-1/2" dust port is standard on many makes of band saws, belt sanders and other woodworking machines. Our customers will be looking for use options, so don't miss this important item.



W2046 \$4.10

W1050 Dust Collection Handbook

This book skillfully guides the woodworker through all the steps necessary in the design and construction of an efficient dust collection system and provides tips for easy installation. Fifty pages of concise information including photographs and illustrations. A must for setting up a dust collection system.

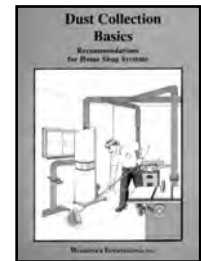

W1050 \$6.00

W1049 Dust Collection Separator

Increases the efficiency and capacity of a standard 30-gallon metal trash can*, this molded ABS fitting is engineered to use cyclonic action to drop out larger particles from the dust flow. The fitting features molder inlets and outlets which can be easily connected to standard systems using 4" flexible hose.



* Metal trash can must be used for grounding purpose. Fits cans with 20" to 21" diameter opening.

W1049 \$34.30

Power Feeder Wheels

PART #	DESCRIPTION	PRICE
PF3JR-249	Small Wheels	\$20.00 ea
6289116	Large Wheels Set of 3	\$69.00
6289118	Large Wheels Set of 4	\$92.00

Specifications Small Wheels:
 Diameter - 3-1/8", Width - 1-1/8",
 Bore - 7/8".

Specifications Large Wheels:
 Diameter - 4-3/4", Width - 2-1/4",
 Bore - 1-1/4".

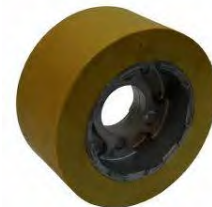

WOODSTOCK

Hard Sanding Sleeve - 3pk



Size	60 Grit	Price	80 Grit	Price	100 Grit	Price	120 Grit	Price	150 Grit	Price
1/4" * 5"	D1400	\$5.50	D1401	\$5.50	D1402	\$5.50	D1403	\$5.50	D1404	\$5.50
3/8" * 6"	D1405	\$6.50	D1406	\$6.50	D1407	\$6.50	D1408	\$6.50	D1409	\$6.50
1/2" * 2"	D1415	\$3.10	D1416	\$3.10	D1417	\$3.10	D1418	\$3.10	N/A	
1/2" * 6"	D1420	\$6.50	D1421	\$6.50	D1422	\$6.50	D1423	\$6.50	D1424	\$6.50
5/8" * 6"	D1425	\$7.00	D1426	\$7.00	D1427	\$7.00	D1428	\$7.00	D1429	\$7.00
3/4" * 2"	D1435	\$3.30	D1436	\$3.30	D1437	\$3.30	D1438	\$3.30	N/A	
3/4" * 9"	D1440	\$10.00	D1441	\$10.00	D1442	\$10.00	D1443	\$10.00	D1444	\$10.00
1" * 2"	D1450	\$3.50	D1451	\$3.50	D1452	\$3.50	D1453	\$3.50	N/A	
1" * 9"	D1455	\$11.00	D1456	\$11.00	D1457	\$11.00	D1458	\$11.00	D1459	\$11.00
1-1/2" * 2"	D1465	\$3.70	D1466	\$3.70	D1467	\$3.70	D1468	\$3.70	N/A	
1-1/2" * 9"	D1475	\$12.00	D1476	\$12.00	D1477	\$12.00	D1478	\$12.00	D1479	\$12.00
2" * 9"	D1490	\$14.00	D1491	\$14.00	D1492	\$14.00	D1493	\$14.00	D1494	\$14.00
3" * 9"	D1500	\$6.00	D1501	\$6.00	D1502	\$6.00	D1503	\$6.00	D1504	\$6.00
4" * 9"	D1505	\$10.00	D1506	\$10.00	D1507	\$10.00	D1508	\$10.00	D1509	\$10.00

Jointer Pal - Magnetic Jointer Knife Setting Jigs

PART	DESCRIPTION	PRICE
W1210A	Polycarbonate Bodied Jig for 4"-8" Jointers w/ HSS knives	\$34.00
W1211A	Steel bodies Jig for 4"-8" Jointers w/ HSS knives	\$56.00
W1212	Carbide Jig for 4"-8" Jointers w/ Carbide or HSS knives	\$77.00
W1213	Carbide Jig for 6"-10" Jointers w/ Carbide or HSS knives	
W1214	Planer Pal - Standard	

The Jointer Pal knife setting system lets you set jointer knives in perfect alignment every time. It also allows you to shift nicked knives to get a perfect cut to an accuracy of $\pm .001$ ". We offer knives-setting extensions for almost all jointers.



Planer Pal - Jigs

PART	DESCRIPTION	PRICE
W1216	Standard Jig for Steel Knives - Pair	\$99.00
W1215A	Carbide Jig for Steel or Carbide Knives - Single	\$110.00

The patented knives-setting system lets you set planer knives in perfect alignment every time. It also allows you to shift nicked knives in 2-1/2" - 4" cutter heads to get a perfect cut with an accuracy of $\pm .002$ ". Two Jigs are needed for 15" to 20" planers, three jigs for planers over 20". For 12" and smaller planers with 1-7/8" to 2-1/8" cutter heads, use the Planer Pal W1226..

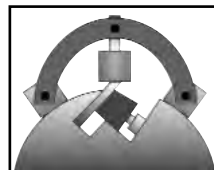

Slickplane

PART	DESCRIPTION	PRICE
W1100	Slickplane-w/ W1101	\$21.00
W1101	CT radius blades/pair	\$10.70
W1102	CT chamfer blades/pair	\$10.70

Produces an exceptionally smooth 1/8" radius or a 45 degree cham-fer. Crafted from select rock maple and is designed to fit comfortably in your hand. A brass sole glides easily along the workpiece edge while two carbide-tipped cutters put on the finishing touch. The cut-ers are easily replaced and can be independently adjusted for com-plete depth of cut control.



W1218A Retractor

Adjust knives and rollers on planers and drum sanders easily. The magnetic base keeps the Retractor firmly in position. The indicator indexes at 0°, 90°, 180°, 270°, and measures to $\pm .001$ ". An extremely precise and useful tool.



W1218 \$114.00

W1226A Mini Planer Pal

We have taken our patented magnetic technology and developed a knife setting jig for all portable planers with standard 1-7/8" to 2-1/8" cutter heads. With over 1 million of these planers on the market, the Mini Planer Pal is a very popular tool. The Mini Planer Pal allows you to set knives perfectly every time to within $\pm .001$ ". Sold in pairs only.

W1226A \$30.00



WOODSTOCK

Calipers

PART	DESCRIPTION	PRICE
D1052	6" Dial Caliper	\$45.20
D1053	8" Dial Caliper	\$70.00
D1054	6" Vernier Caliper	

These precision Dial and Vernier Calipers can measure small parts and thickness of everything from lumber to sheets of paper. Easy one-hand operation provides inside, outside and depth measurements in precise .001" increments.



W1320 Router Pads

These handy rubber work pads are indispensable for routing. All pads are 24" wide x 36" long and 1/8" thick.

W1320 \$13.40

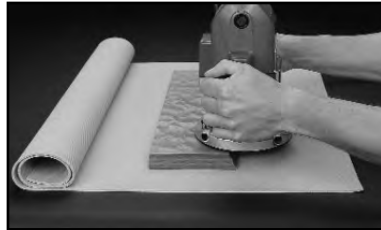

D1060 - Pocket Hole Guide

Perfect for those "do-it-yourselfers" who wish to build kitchen cabinets, Steelex offers the face frame pocket hole guide. This handy jig allows precisely angled holes ready for the screws that will hold face frame parts together.

7/8" Thru 2-1/4"
Hardened Steel Bushings
Centering Marks

D1060 \$14.70



Dead Blow Hammers

PART	WEIGHT	PRICE
D1084	8 oz	\$13.40
D1085	16 oz	\$17.00
D1086	24 oz	\$24.20
D1087	32 oz	\$33.30

These hammers belong in the toolboxes of woodworkers and machinists alike. Unlike rubber mallets, dead blow hammers won't bounce off your work. Sealed lead shot in the hammers head delivers all the kinetic force to the contact point - exactly where it should be.



D1098 - Lathe Insert 1"-8 TPI Right Hand

\$7.50

These Steelex® top quality 1" x 8 TPI - RH lathe inserts make Steelex® 3 and 4-Jaw Chucks and 8" Face Plate adaptable to a wide range of wood lathes.



Step Drill

PA	Angel	PRICE
D1114	45°	\$10.80
D1115	90°	\$10.80



Precision Stop Block

PART	DESCRIPTION	PRICE
W1205	6 Left Reading Tape (Measures from right to left)	\$9.70
W1206	6 Right Reading Tape (Measures from left to right)	\$9.70
W1109	Broset Precision Stop Block	\$48.80

The BROSET precision stop blocks are great labor-saving devices when cross cutting on miter and radial arm saws. They can even be used on router tables and shapers to precisely limit the travel of the workpiece. Ideal for cutting multiple pieces to the same size, they also eliminate measuring, marking and adjusting the work piece to the saw blade when cutting single pieces. The BROSET is designed for use with self-stick measuring tape (optional) for instant positioning, and features micro-adjustable stops and two magnified hairline cursors for left and right of the blade operation. Works with fences from 1-1/2" to 2" wide.



Dial Indicators

PART	DESCRIPTION	PRICE
D1056	1/2" TRAVEL x 0.001"	\$18.50
D1057	1" TRAVEL x 0.001"	\$21.90

Dial indicators are a necessity in any shop - woodworking and metalworking alike. Use them with magnetic bases for measuring run-out, setting up tools and checking alignment.



D1058 Magnetic Bases for Dial Indicators

This high quality base has a very strong magnet that is easy activated with a convenient switch. Mounts at any angle and has a fine-adjustment arm.

D1058 \$32.20



Shop Fox Dust Collector Bag

PART	DESCRIPTION	PRICE
D1795	Upper Bag	\$33.50
D1796	Lower Bag	\$33.70

D2271—Heavy-Duty 9 Roller Table

19" x 65" Long
26-3/8" - 44-1/8" Tall
1000 lb. Capacity
9 Ball Bearing Rollers

\$250.20



WOODSTOCK

Woodworking Accessories - Board Buddies

A necessity for the safety-conscious woodworker, our BOARD BUDDIES® maintain simultaneous, even pressure against the table and fence. Your customers will find that using them will result in safer, cleaner cutting operations. All BOARD BUDDIES® are completely adjustable to accommodate various lumber thicknesses. BOARD BUDDIES® are shipped two per set and mount directly onto your customers' shop-made wood fences. Optional sliding tracks available. For Radial Arm Saws these BOARD BUDDIES® feature orange wheels that turn counter-clockwise to prevent kickback on radial arm saws and router tables. Mounts to fences 3" - 3 1/2" high x 1" or wider.



W1104 For Table Saws and Router Tables. The yellow wheels on these BOARD BUDDIES® turn clockwise to prevent kickback on table saws and router tables. Mounts to fences 3" to 3-1/2" high x 1" or wider. **\$65.30**

W1105 For Shapers. These BOARD BUDDIES® are made from die-cast aluminum and feature non-marring green neoprene rubber wheels. Because the wheels turn in both directions, they function as hold-downs rather than anti-kickback devices. Mounts to fences 3" - 3 1/2" high x 1" or wider. **\$65.30**

W1106 For Radial Arm Saws. These BOARD BUDDIES® feature orange wheels that turn counter-clockwise to prevent kickback on radial arm saws. Mounts to fence 3" to 3-1/2" high x 1" or wider. **\$58.30**

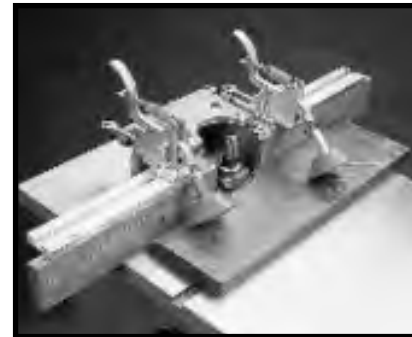

Optional Tracks for Board Buddies®
 W1107 - 12" Track **\$16.50**
 W1108 - 24" Track **\$29.00**

Shop Fox Right Angle Jig

PART	DESCRIPTION	PRICE
W1500	Shop Fox Right Angle Jig	\$274.50

W1323A Clamping Miter Gauge

Our Clamping Miter Gauge is safer than standard miter gauges. It has a comfortable D-handle grip, built-in sliding stop, and positive trigger clamping action. It fits standard miter gauge slots, 3/8" x 3/4", with positive angle stops at 90° and 45° both left and right. Bar extends to 12".

W1323A \$60.00

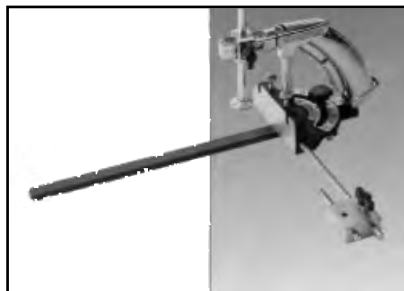

W1301 6" Vice Clamp

Our Vice Clamps adjust quickly and easily to lock your work piece in any position. The clamping pad pivots to conform to any work piece, ensuring uniform pressure.

W1301 \$15.50



Cut tenons, dados, rail ends, finger joints, etc. safely and with complete accuracy.



Other benefits includes:

- Eliminates the need to construct many other jigs and fixtures.
- Amazingly affordable.
- Simple to set up and use.
- Extremely durable.
- Easily adjustable.
- Offers increased operator safety.

Specifications:

Depth (Fully Extended): 13"
 Depth (Closed) 7-1/2"
 Width: 13"
 Height: 8"
 Miter Bar Size: 3/8" x 3/4" x 11"
 Handholds: 45°, Moulded
 Max. Horizontal Opening: 1-3/4" x 8"

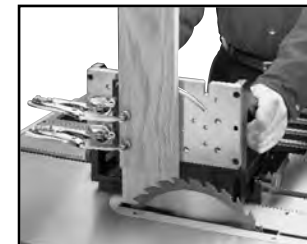

WOODSTOCK

D2192—10" Drill Press Clamp

\$19.00



D2230—2-1/2" Deep Throat C-Clamp

\$9.00



Steelex Sharpening Stone Holder with Rubber Base

Rubber body keeps sharpening stones from sliding around the bench top during honing. Chrome plated hardware resists rust when using waterstones. Adjusts from 5 1/2" to 9" to fit a wide range of stone sizes.

D1091 \$18.10

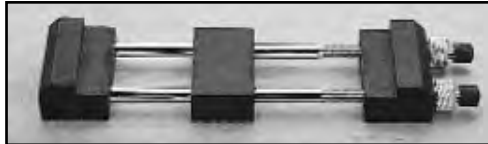

Waterstones

PART	GRIT	PRICE
D1067	800	\$29.50
D1068	1000	\$36.00
D1069	1200	\$37.50
D1070	6000	\$74.50
D1071	8000	\$145.90
D1130	1000 / 6000	\$53.00

Woodworkers of all skill levels are turning to Japanese waterstones to keep their tool edges sharp. This is because waterstones cut more aggressively, and a sharp edge can be achieved much faster. Waterstones also polish as they hone, allowing a mirror finish without the need for stropping or polishing compounds. Only water is needed to lubricate the cutting edge.



PRO-STICK Abrasive Belt and Disc Cleaner



PART	SIZE	PRICE
W1307	2" x 2" x 12"	\$17.10
W1307 Buy 2-5	2" x 2" x 12"	\$14.54
W1307 Buy 6 or more	2" x 2" x 12"	\$12.83

D2664—6" HD Quick Release Bar Clamp

D2665—12" HD Quick Release Bar Clamp



D2268—Right Angle Clamp

\$18.60



D2269—Face Frame Clamp

\$19.00



D1044 Honing Guide

The proper bevel angle is crucial for keeping a sharp edge. Our Steelix honing guide ensures the perfect angle every time.

D1044 \$11.50



Steelex Oilstone Sharpening Kit

This all-in-one handles most woodworkers honing chores. Includes a D1117 8" combination (coarse/medium) aluminum oxide sharpening stone, our D1044 honing guide, a 1 oz bottle of honing oil and a special non slip rubber pad.



D1117 \$17.50

D1118 \$17.50

W1053 Grounding Kit

All dust collection systems build up static electricity, and if not grounded, that electricity becomes a hazard that could start a fire. Our grounding kit provides everything you need to ground a dust collection system, including directions for installation. A large system may need more than one kit, so keep plenty of these on hand. This safety accessory is essential to any complete dust collection assortment.

W1053 \$12.50



W1400 Push Block

Push blocks are constructed of high-impact molded plastic with natural rubber friction pads that grip the work piece firmly. Woodworkers can work with confidence knowing that these pads are between their fingers and the cutting tool. Bright, safety-orange color makes them easy to find.

W1400 \$4.60



WOODSTOCK

3/4" Bore Rub Collar

PART	O.D. x I.D.	PRICE
W1114	1-5/8 x 3/4	\$14.70
W1115	1-11/16 x 3/4	\$16.20
W1116	1-3/4 x 3/4	\$16.20
W1117	1-27//32 x 3/4	\$16.20
W1118	1-7/8 x 3/4	\$16.20
W1119	2 x 3/4	\$17.10
W1120	2-1/8 x 3/4	\$17.10
W1121	2-3/16 x 3/4	\$18.00
W1122	2-5/8 x 3/4	\$18.40
W1123	2-15/16 x 3/4	\$18.90
W1132	2-1/16 x 3/4	\$17.10
W1133	2-1/4 x 3/4	\$18.40
W1134	2-5/16 x 3/4	\$18.00
W1135	2-3/8 x 3/4	\$18.00
W1136	2-7/16 x 3/4	\$18.40
W1137	2-1/2 x 3/4	\$18.40
W1138	2-9/16 x 3/4	\$18.90
W1139	2-11/16 x 3/4	\$18.90
W1140	2-3/4 x 3/4	\$19.30
W1143	2-13/16 x 3/4	\$18.90
W1144	2-7/8 x 3/4	\$18.90

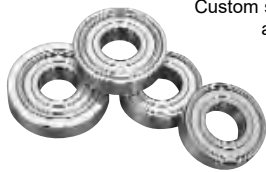

Custom size rubber bearings are also available upon request.

1/2" Bore Rub Collar

PART	O.D. x I.D.	PRICE
W1110	1-1/8 x 1/2	\$9.10
W1111	1-1/4 x 1/2	\$9.90
W1112	1-3/8 x 1/2	\$12.90
W1113	1-1/2 x 1/2	\$13.90

1-1/4" Bore Rub Collar

PART	O.D. x I.D.	PRICE
W1124	2-1/4 x 1-1/4	\$25.20
W1125	2-1/2 x 1-1/4	\$26.30
W1126	2-3/4 x 1-1/4	\$26.30
W1127	3 x 1-1/4	\$26.10
W1128	3-1/4 x 1-1/4	\$26.10
W1129	3-3/8 x 1-1/4	\$27.00
W1130	3-1/2 x 1-1/4	\$28.40
W1131	4 x 1-1/4	\$30.30

Custom size rubber bearings are also available upon request.

T-Bushings

PART	O.D. x I.D. x SHANK HT. x O.A. HT.	PRICE
W1151	1-1/4 x 1 x 1/4 x 3/8	\$3.50
W1152	1-1/4 x 3/4 x 1/4 x 3/8	\$3.50
W1153	1 x 3/4 x 1/4 x 3/8	\$3.50
W1154	3/4 x 1/2 x 3/16 x 5/16	\$2.40
W1183	Deluxe T-bushing Set of 8 (2 of each size T-bushing)	\$25.30



Long T-Bushings

PART	O.D. x I.D. x SHANK HT. x O.A. HT.	PRICE
W1147	1-1/4 x 1 x 1-3/16 x 1-5/16	\$5.80
W1148	1-1/4 x 3/4 x 1-3/16 x 1-5/16	\$5.80
W1149	1 x 3/4 x 1-3/16 x 1-5/16	\$5.70
W1150	3/4 x 1/2 x 1-3/16 x 1-5/16	\$5.00



Double T-Bushings

PART	O.D. x I.D. x O.A. HT.	PRICE
W1179	1-1/4 x 1 x 7/8	\$5.10
W1180	1-1/4 x 3/4 x 7/8	\$4.80
W1181	1 x 3/4 x 3/4	\$4.50
W1182	3/4 x 1/2 x 11/16	\$4.30



Straight Bushings

PART	O.D. x I.D. x O.A. HT.	PRICE
W1155	1-1/4 x 1 x 7/16	\$2.80
W1156	1-1/4 x 3/4 x 7/16	\$2.70
W1157	1 x 3/4 x 7/16	\$2.50
W1158	3/4 x 1/2 x 7/16	\$2.40



W1145 4 Pc. Rub Collar Set - 1/2" Bore

- 1 - 1-1/8" O.D. x 1/2" I.D. Rub Collar (W1110)
- 1 - 1-1/4" O.D. x 1/2" I.D. Rub Collar (W1111)
- 1 - 1-3/8" O.D. x 1/2" I.D. Rub Collar (W1112)
- 1 - 1-1/2" O.D. x 1/2" I.D. Rub Collar (W1113)

\$250.20

Spacers for 1/2" Spindles

PART	O.D. x I.D. x O.A. HT.	PRICE
W1159	1 x 1/2 x 1/4	\$2.30
W1160	1 x 1/2 x 3/8	\$2.30
W1161	1 x 1/2 x 1/2	\$2.50
W1162	1 x 1/2 x 3/4	\$2.70
W1163	1 x 1/2 x 1	\$2.90



Spacers for 3/4" Spindles

PART	O.D. x I.D. x O.A. HT.	PRICE
W1164	1-1/4 x 3/4 x 1/4	\$3.00
W1165	1-1/4 x 3/4 x 3/8	\$2.90
W1166	1-1/4 x 3/4 x 1/2	\$3.30
W1167	1-1/4 x 3/4 x 3/4	\$3.20
W1168	1-1/4 x 3/4 x 1	\$3.30

Spacers for 1" Spindles

PART	O.D. x I.D. x O.A. HT.	PRICE
W1169	1-1/2 x 1 x 1/4	\$3.40
W1170	1-1/2 x 1 x 3/8	\$3.40
W1171	1-1/2 x 1 x 1/2	\$3.40
W1172	1-1/2 x 1 x 3/4	\$3.60
W1173	1-1/2 x 1 x 1	\$3.90



Spacers for 1-1/4" Spindles

PART	O.D. x I.D. x O.A. HT.	PRICE
W1174	1-3/4 x 1-1/4 x 1/4	\$4.20
W1175	1-3/4 x 1-1/4 x 3/8	\$4.20
W1176	1-3/4 x 1-1/4 x 1/2	\$4.10
W1177	1-3/4 x 1-1/4 x 3/4	\$4.50
W1178	1-3/4 x 1-1/4 x 1	\$4.60



W1146 5 Pc. Rub Collar Set - 3/4" Bore

- 1 - 1-5/8" O.D. x 3/4" I.D. Rub Collar (W1114)
- 1 - 1-7/8" O.D. x 3/4" I.D. Rub Collar (W1118)
- 1 - 2" O.D. x 3/4" I.D. Rub Collar (W1119)
- 1 - 2-1/8" O.D. x 3/4" Rub Collar (W1120)
- 1 - 2-3/16" O.D. x 3/4" Rub Collar (W1121)
- 2 - 3/4" O.D. x 1/2" I.D. x 7/16" O.H. Straight Bushing (W1158)

\$250.20

W1185—5 Pc. Rub Collar Set "B" 3/4" Bore

- 1 - 2-1/4" O.D. x 3/4" I.D. Rub Collar (W1133)
- 1 - 2-5/16" O.D. x 3/4" I.D. Rub Collar (W1134)
- 1 - 2-3/8" O.D. x 3/4" I.D. Rub Collar (W1135)
- 1 - 2-7/16" O.D. x 3/4" I.D. Rub Collar (W1136)
- 1 - 2-1/2" O.D. x 3/4" I.D. Rub Collar (W1137)
- 2 - 3/4" O.D. x 1/2" I.D. Straight Bushings (W1158)

\$250.20

WOODSTOCK

D2677—Spindle Sander Drum Kit for Drill Press

- 1" Diameter
- 1-1/2" Diameter
- 2" Diameter
- 4-1/4" Long
- 80 Grit Sleeves



\$11.00

**D2722
Mandrel for D2677
Drum Sander Set -
3/8" Shank**



\$6.50

D2844—Mortising Chisel 3/4"

These Mortising Chisels are great for drilling square holes in wood with a mortising machine or a mortising attachment (not included).



\$24.70

D2845—4 pc. 1/4" - 1/2" Mortising Chisel Set

These Mortising Chisels are great for drilling square holes in wood with a mortising machine or a mortising attachment (not included). Set of 4 includes the following sizes: 1/4", 5/16", 3/8" and 1/2". This quality set also comes with a convenient plastic storage case.



\$46.50

D2796—12" Dovetail Jig with Aluminum Template

12" Wide Capacity
1/2" - 1-1/4" Stock Capacity
Makes 1/2" half-blind dovetails.
1/2" Aluminum Template Included
Cam-Action Clamping System



\$90.00

**D2914 - 7/16" Aluminum Dovetail Template
D2915 - 9/16" Aluminum Dovetail Template
D2926 - 1/2" Aluminum Dovetail Template**

12" Long Capacity
1-1/4" Thick Capacity
Aluminum



D2246—Extension Kit #2 - 36" Bars for D2058 \$34.00

D2259—Extension Kit for D2057 & D2260 Mobile Bases \$70.00



D2726—Hold Down Clamp for T-Slot Tracks

\$5.30



D3003—PRO-STIK® 15" x 20" Cleaning Pad



\$106.80

D3038—110V Dust Collection Remote Switch

110v
For dust collectors up to 1-1/2HP/20Amps
2 - Remote Controls
9v Batteries Included

D3346—220V Dust Collector Remote Switch

220v
For up to 3HP/20Amp dust collectors.
75 ft. Range
2 - Remote Control
9v Batteries Included



W1302 DISC9" VISE CLAMP

W1306 PRO-STIK 1-1/2" x 8-1/2" Abrasive Belt/Disk Cleaner \$8.90

W1313 2-1/2" Hose Clamp \$8.60

W1314 2-1/2" Wire Hose Clamp \$0.54

D3122—Push Stick

\$9.70



Woodstock

D3132—2-1/2" X 9" Magnetic Jaw Pads

Set of 2
2-1/2" x 9"
Magnetic



D3158—1/4" Box Joint Template

1/4" Box Joint
12" Long Capacity
1-1/4" Thick Capacity
Aluminum



D3171—Shelf Support Boring Jig For 13/64" pin holes.

\$26.00



D3381—Ball Roller Kit - Set of 6

1" Hardened Ball Bearings
360° Rotation
Mounting Screws Included

\$24.20



W1096—7/16" Dovetail Template

\$7.40

W1097—1/2" Dovetail Template

\$7.40

W1098—9/16" Dovetail Template

\$7.40



D3205—25 Pc. Quick Change Bit Set

- 1 - Quick Change Holder
- 5 - Phillips® Power Screwdriver Bits
- 4 - Slotted Power Screwdriver Bits
- 2 - Phillips® and Slot 6" Powerbits
- 7 - Hex Shank Titanium Nitride Coated Drill Bits
- 3 - Hex Shank Nutsetters
- 3 - Square Recess Power Screwdriver Bits



D3290—Band Clamp

15' Long
Ratchet Mechanism
Nylon Webbing

\$10.00



D3324—1-3/4" Cove Moulding Knife - Set of 2 HSS

\$48.90



D3333 -- 2-1/4" Crown Moulding Knife - Set of 2

\$61.00

D3335 -- 3-1/4" Crown Moulding Knife - Set of 2

\$73.80

D3338 -- 4-5/8" Crown Moulding Knife - Set of 2

\$109.90

HSS
Indexable



W1250—Rosette Cutterhead

\$38.80

1/2" Shank
Makes 3" Rosettes with ease on any drill press.
Unique design eliminates two knife hassles.



W1254—3" Rabbeting Rabbeting Knife

\$14.20



W1263—2-1/2" Rosette Knife

\$14.20

W1264—3" Rosette Knife

\$14.20

W1272—2-13/16" Rosette Knife

\$14.20



Providing Woodworking Professionals with Quality Tools for over 47 Years.



For those using G.P.S. navigation systems, Ballew Saw & Tool is at
Latitude: 37.207216
Longitude: -93.287021



Ballew Saw & Tool, Inc. is the best place woodworkers turn to for machinery, tooling and accessories. With literally thousands of items at your fingertips from dozens of well known companies, our catalog is the only thing you'll need to find the right tool to finish any job in your workshop.

Phone: 1-800-288-7483

Fax: 417.865.3797

Website: www.ballewsaw.com

Follow us on Twitter and Facebook



PRINTED ON RECYCLED PAPER



www.twitter.com/BallewSaw



www.facebook.com/BallewSaw